

isc N-Channel MOSFET Transistor

IPW60R040C7

IIPW60R040C7

• FEATURES

- Static drain-source on-resistance:
 $R_{ds(on)} \leq 40m\Omega$
- Enhancement mode:
- 100% avalanche tested
- Minimum Lot-to-Lot variations for robust device performance and reliable operation

• DESCRIPTION

- Suitable for hard and soft switching

• ABSOLUTE MAXIMUM RATINGS(T_a=25°C)

SYMBOL	PARAMETER	VALUE	UNIT
V _{DSS}	Drain-Source Voltage	600	V
V _{GS}	Gate-Source Voltage	±20	V
I _D	Drain Current-Continuous	50	A
I _{DM}	Drain Current-Single Pulsed	211	A
P _D	Total Dissipation @T _c =25°C	227	W
T _j	Max. Operating Junction Temperature	150	°C
T _{stg}	Storage Temperature	-55~150	°C

• THERMAL CHARACTERISTICS

SYMBOL	PARAMETER	MAX	UNIT
R _{th(j-c)}	Channel-to-case thermal resistance	0.55	°C/W
R _{th(j-a)}	Channel-to-ambient thermal resistance	62	°C/W

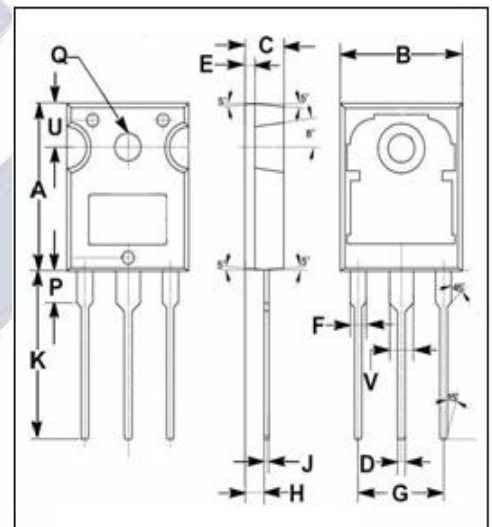
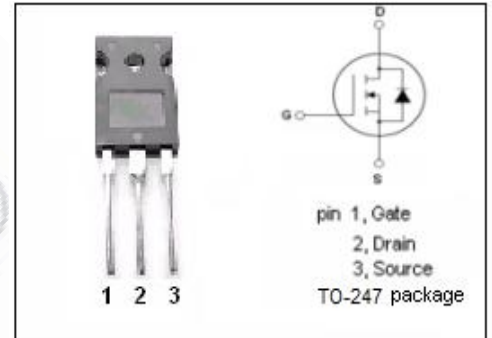

DIM	mm	
	MIN	MAX
A	19.80	20.20
B	15.40	15.80
C	4.90	5.10
D	0.90	1.10
E	1.40	1.60
F	1.90	2.10
G	10.80	11.00
H	2.40	2.60
J	0.50	0.70
K	19.50	20.50
P	3.90	4.10
Q	3.30	3.50
U	5.20	5.40
V	2.90	3.10

isc N-Channel MOSFET Transistor
IPW60R040C7
IIPW60R040C7
ELECTRICAL CHARACTERISTICS

 T_c=25°C unless otherwise specified

SYMBOL	PARAMETER	CONDITIONS	MIN	TYP	MAX	UNIT
B _{VDS}	Drain-Source Breakdown Voltage	V _{GS} =0V; I _D =1mA	600			V
V _{GS(th)}	Gate Threshold Voltage	V _{DS} =V _{GS} ; I _D =1.24mA	3		4	V
R _{DS(on)}	Drain-Source On-Resistance	V _{GS} =10V; I _D =24.9A			40	mΩ
I _{GSS}	Gate-Source Leakage Current	V _{GS} = 20V; V _{DS} = 0V			0.1	μA
I _{DSS}	Drain-Source Leakage Current	V _{DS} =600V; V _{GS} = 0V			1	μA
V _{SD}	Diode forward voltage	I _F =24.9A, V _{GS} = 0V				V