

# IFX25001

Low Dropout Voltage Regulator

## Data Sheet

Rev. 1.02, 2010-05-20

Standard Power



## 1 Overview

### Features

- Output Voltages: 2.5, 3.3, 5.0, 8.5, or 10.0 V
- Output Current up to 400 mA
- Low Current Consumption
- Wide Input Voltage Range up to 45V
- Low Dropout Voltage
- Output Current Limitation
- Reverse Polarity Protection
- Overtemperature Shutdown
- Wide Temperature Range, -40 °C to 125 °C
- Green Product (RoHS compliant)

### Applications

- Manufacturing Automation
- Appliances
- HDTV Televisions
- Game Consoles
- Network Routers

For automotive and transportation applications, please refer to the Infineon TLE and TLF voltage regulator series.

### Description

The IFX25001 is a low dropout linear voltage regulator available in a 2.5, 3.3, 5.0, 8.5, or 10.0 V output. It is capable of supplying continuous output current up to 400 mA. A wide input voltage range up to 45V enables the IFX25001 to operate in a large variety of applications. The IFX25001 is also protected against overload, short circuit and overtemperature conditions.

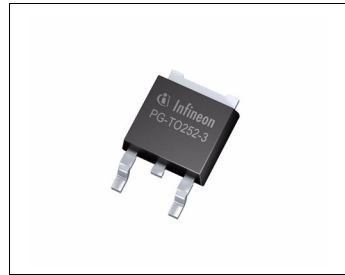

PG-TO252-3

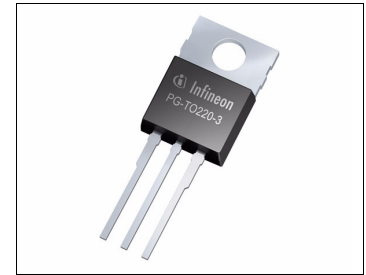

PG-TO220-3



PG-TO263-3

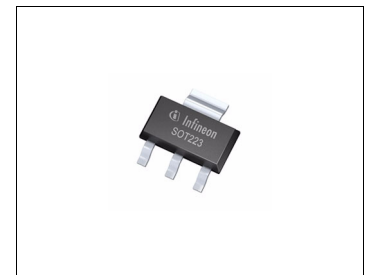

PG-SOT223-4

| Type            | Package     | Marking  |
|-----------------|-------------|----------|
| IFX25001 ME V25 | PG-SOT223-4 | 25001A   |
| IFX25001 ME V33 | PG-SOT223-4 | 25001B   |
| IFX25001 TF V33 | PG-TO252-3  | 2500133  |
| IFX25001 TS V50 | PG-TO220-3  | 25001V50 |
| IFX25001TF V50  | PG-TO252-3  | 2500150  |
| IFX25001 TC V50 | PG-TO263-3  | 25001V50 |
| IFX25001 TS V85 | PG-TO220-3  | 25001V85 |
| IFX25001 TC V85 | PG-TO263-3  | 25001V85 |
| IFX25001 TS V10 | PG-TO220-3  | 25001V10 |
| IFX25001 TC V10 | PG-TO263-3  | 25001V10 |

## 2 Block Diagram

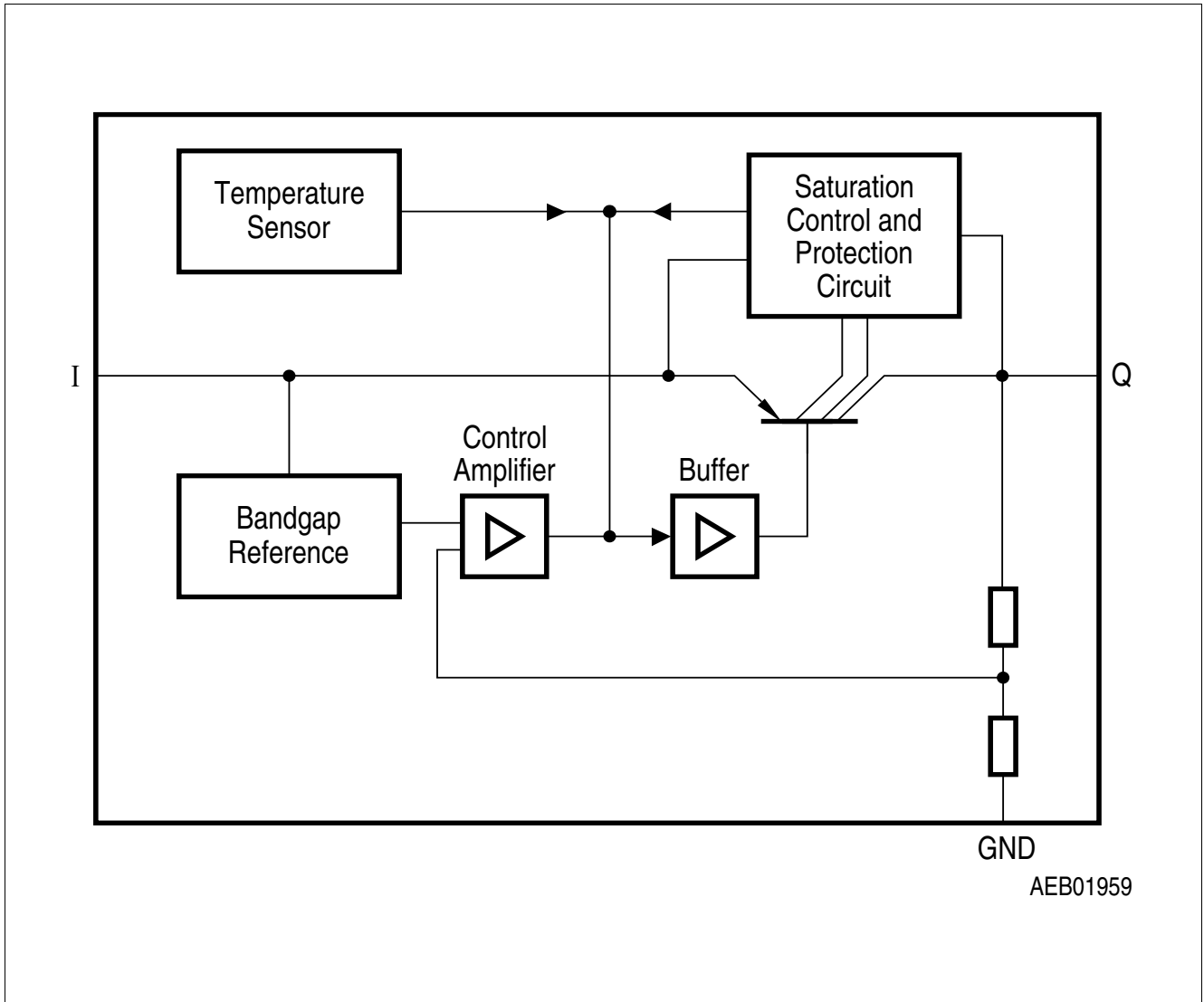

Figure 1 Block Diagram

### 3 Pin Configuration

#### 3.1 Pin Assignment PG-SOT223-4, PG-TO252-3, PG-TO263-3, and PG-TO220-3

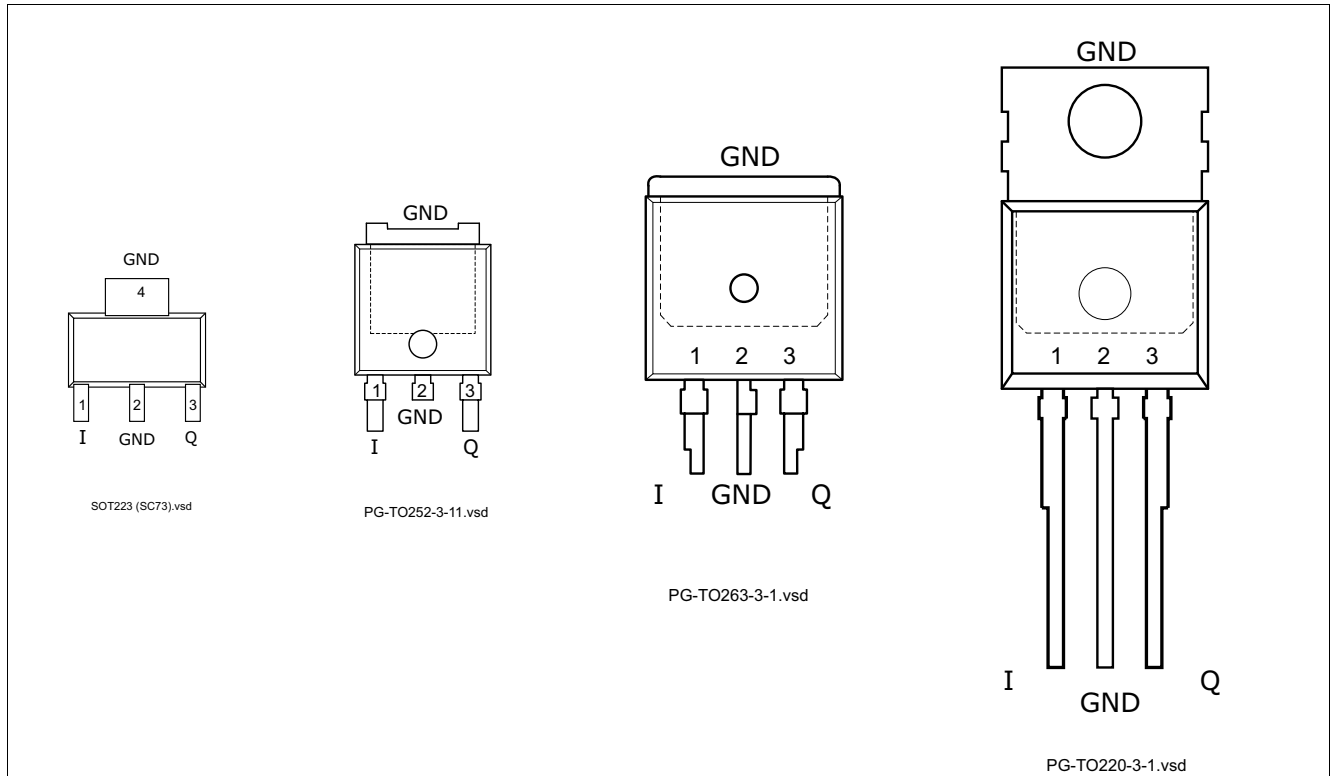

Figure 2 Pin Configuration (top view)

#### 3.2 Pin Definitions and Functions PG-SOT223-4, PG-TO252-3, PG-TO263-3, and PG-TO220-3

| Pin No.       | Symbol | Function  |
|---------------|--------|---|
| 1             | I      | <b>Input</b><br>connect Input pin to positive DC voltage source (e.g. battery);<br>a small filter capacitor connected close to the Input pin and GND is recommended |
| 2             | GND    | <b>Ground</b><br>internally connected to heat slug pin  |
| 3             | Q      | <b>Output</b><br>connect a capacitor close to the Output pin and GND according to the values specified in <b>“Functional Range” on Page 5</b>                       |
| 4 / Heat Slug | GND    | <b>Heat Slug</b><br>internally connected to GND pin;<br>connect to heatsink to improve thermal performance  |

## 4 General Product Characteristics

### 4.1 Absolute Maximum Ratings

#### Absolute Maximum Ratings<sup>1)</sup>

$T_j = -40\text{ °C}$  to  $150\text{ °C}$ ; all voltages with respect to ground, (unless otherwise specified)

| Pos.               | Parameter            | Symbol    | Limit Values |      | Unit | Test Condition |
|--------------------|----------------------|-----------|--------------|------|------|----------------|
|                    |                      |           | Min.         | Max. |      |                |
| <b>Input I</b>     |                      |           |              |      |      |                |
| 4.1.1              | Voltage              | $V_I$     | -42          | 45   | V    | –              |
| <b>Output Q</b>    |                      |           |              |      |      |                |
| 4.1.2              | Voltage              | $V_Q$     | -1           | 40   | V    | –              |
| <b>Temperature</b> |                      |           |              |      |      |                |
| 4.1.3              | Junction temperature | $T_j$     | -40          | 150  | °C   | –              |
| 4.1.4              | Storage temperature  | $T_{stg}$ | -50          | 150  | °C   | –              |

1) not subject to production test, specified by design

*Note: Stresses above the ones listed here may cause permanent damage to the device. Exposure to absolute maximum rating conditions for extended periods may affect device reliability.*

*Note: Integrated protection functions are designed to prevent IC destruction under fault conditions described in the data sheet. Fault conditions are considered as "outside" normal operating range. Protection functions are not designed for continuous repetitive operation.*

### 4.2 Functional Range

| Pos.  | Parameter                                     | Symbol     | Limit Values |      | Unit | Remarks   |
|-------|---|------------|--------------|------|------|---|
|       |   |            | Min.         | Max. |      |   |
| 4.2.1 | Input voltage                                 | $V_I$      | 4.7          | 40   | V    | IFX25001 ME V25<br>IFX25001 ME V33<br>IFX25001 TF V33 |
| 4.2.2 |   | $V_I$      | 5.5          | 40   | V    | IFX25001 TS V50<br>IFX25001TF V50<br>IFX25001 TC V50  |
| 4.2.3 |   | $V_I$      | 9.0          | 40   | V    | IFX25001 TS V85<br>IFX25001 TC V85                    |
| 4.2.4 |   | $V_I$      | 10.5         | 40   | V    | IFX25001 TS V10<br>IFX25001 TC V10                    |
| 4.2.5 | Output Capacitor's Requirements for Stability | $C_Q$      | 22           | –    | µF   | <sup>1)</sup>   |
| 4.2.6 |   | $ESR(C_Q)$ | –            | 3    | Ω    | <sup>2)</sup>   |
| 4.2.7 | Junction temperature                          | $T_j$      | -40          | 125  | °C   | –   |

1) the minimum output capacitance requirement is applicable for a worst case capacitance tolerance of 30%

2) relevant ESR value at  $f = 10\text{ kHz}$

*Note: Within the functional or operating range, the IC operates as described in the circuit description. The electrical characteristics are specified within the conditions given in the Electrical Characteristics table.*

### 4.3 Thermal Resistance

Note: This thermal data was generated in accordance with JEDEC JESD51 standards. For more information, go to [www.jedec.org](http://www.jedec.org).

| Pos.               | Parameter                         | Symbol     | Limit Values |      |      | Unit | Conditions                                      |
|--------------------|-----------------------------------|------------|--------------|------|------|------|---|
|                    |                                   |            | Min.         | Typ. | Max. |      |   |
| <b>PG-TO252-3</b>  |                                   |            |              |      |      |      |   |
| 4.3.1              | Junction to Case <sup>1)</sup>    | $R_{thJC}$ | –            | 4    | –    | K/W  | measured to heat slug                           |
| 4.3.2              | Junction to Ambient <sup>1)</sup> | $R_{thJA}$ | –            | 27   | –    | K/W  | <sup>2)</sup>                                   |
| 4.3.3              |                                   | $R_{thJA}$ | –            | 57   | –    | K/W  | 300 mm <sup>2</sup> heatsink area <sup>3)</sup> |
| 4.3.4              |                                   | $R_{thJA}$ | –            | 42   | –    | K/W  | 600 mm <sup>2</sup> heatsink area <sup>3)</sup> |
| <b>PG-TO263-3</b>  |                                   |            |              |      |      |      |   |
| 4.3.5              | Junction to Case <sup>1)</sup>    | $R_{thJC}$ | –            | 4    | –    | K/W  | measured to heat slug                           |
| 4.3.6              | Junction to Ambient <sup>1)</sup> | $R_{thJA}$ | –            | 22   | –    | K/W  | <sup>2)</sup>                                   |
| 4.3.7              |                                   | $R_{thJA}$ | –            | 42   | –    | K/W  | 300 mm <sup>2</sup> heatsink area <sup>3)</sup> |
| 4.3.8              |                                   | $R_{thJA}$ | –            | 33   | –    | K/W  | 600 mm <sup>2</sup> heatsink area <sup>3)</sup> |
| <b>PG-TO220-3</b>  |                                   |            |              |      |      |      |   |
| 4.3.9              | Junction to Case <sup>1)</sup>    | $R_{thJC}$ | –            | 8    | –    | K/W  | measured to exposed pad                         |
| <b>PG-SOT223-4</b> |                                   |            |              |      |      |      |   |
| 4.3.10             | Junction to Case <sup>1)</sup>    | $R_{thJC}$ | –            | 25   | –    | K/W  | measured to heat slug                           |
| 4.3.11             | Junction to Ambient <sup>1)</sup> | $R_{thJA}$ | –            | 51   | –    | K/W  | <sup>2)</sup>                                   |
| 4.3.12             |                                   | $R_{thJA}$ | –            | 75   | –    | K/W  | 300 mm <sup>2</sup> heatsink area <sup>3)</sup> |
| 4.3.13             |                                   | $R_{thJA}$ | –            | 63   | –    | K/W  | 600 mm <sup>2</sup> heatsink area <sup>3)</sup> |

1) Not subject to production test, specified by design.

2) Specified  $R_{thJA}$  value is according to Jedec JESD51-2,-5,-7 at natural convection on FR4 2s2p board; The Product (Chip+Package) was simulated on a 76.2 x 114.3 x 1.5 mm<sup>3</sup> board with 2 inner copper layers (2 x 70µm Cu, 2 x 35µm Cu). Where applicable a thermal via array under the exposed pad contacted the first inner copper layer.

3) Specified  $R_{thJA}$  value is according to Jedec JESD 51-3 at natural convection on FR4 1s0p board; The Product (Chip+Package) was simulated on a 76.2 x 114.3 x 1.5 mm<sup>3</sup> board with 1 copper layer (1 x 70µm Cu).

## 5 Electrical Characteristics

### 5.1 Electrical Characteristics Voltage Regulator

**Electrical Characteristics**
 $V_I = 13.5 \text{ V}$ ;  $T_j = -40 \text{ }^\circ\text{C}$  to  $125 \text{ }^\circ\text{C}$ ; all voltages with respect to ground (unless otherwise specified)

| Pos.            | Parameter       | Symbol   | Limit Values |      |      | Unit | Measuring Condition  |
|-----------------|-----------------|----------|--------------|------|------|------|--|
|                 |                 |          | Min.         | Typ. | Max. |      |  |
| <b>Output Q</b> |                 |          |              |      |      |      |  |
| 5.1.1           | Output Voltage  | $V_Q$    | 9.6          | 10.0 | 10.4 | V    | IFX25001 TS V10,<br>IFX25001 TC V10<br>$5 \text{ mA} < I_Q < 400 \text{ mA}$<br>$11 \text{ V} < V_I < 28 \text{ V}$  |
| 5.1.1           | Output Voltage  | $V_Q$    | 8.16         | 8.5  | 8.84 | V    | IFX25001 TS V85,<br>IFX25001 TC V85<br>$5 \text{ mA} < I_Q < 400 \text{ mA}$<br>$9.5 \text{ V} < V_I < 28 \text{ V}$   |
| 5.1.1           | Output Voltage  | $V_Q$    | 4.8          | 5.0  | 5.2  | V    | IFX25001 TS V50,<br>IFX25001TF V50<br>IFX25001 TC V50<br>$5 \text{ mA} < I_Q < 400 \text{ mA}$<br>$6 \text{ V} < V_I < 28 \text{ V}$   |
| 5.1.2           | Output Voltage  | $V_Q$    | 3.17         | 3.3  | 3.44 | V    | IFX25001 ME V33,<br>IFX25001 TF V33<br>$5 \text{ mA} < I_Q < 400 \text{ mA}$<br>$4.7 \text{ V} < V_I < 28 \text{ V}$   |
| 5.1.3           | Output Voltage  | $V_Q$    | 2.4          | 2.5  | 2.6  | V    | IFX25001 ME V25,<br>$5 \text{ mA} < I_Q < 400 \text{ mA}$<br>$4.7 \text{ V} < V_I < 28 \text{ V}$  |
| 5.1.4           | Dropout Voltage | $V_{dr}$ | –            | 250  | 500  | mV   | IFX25001 TS V50,<br>IFX25001TF V50,<br>IFX25001 TC V50,<br>IFX25001 TS V85,<br>IFX25001 TC V85<br>IFX25001 TS V10,<br>IFX25001 TC V10<br>$I_Q = 250 \text{ mA}$<br>$V_{dr} = V_I - V_Q^{1)}$ |
| 5.1.5           | Dropout Voltage | $V_{dr}$ | –            | 0.7  | 1.2  | V    | IFX25001 ME V33,<br>IFX25001 TF V33;<br>$I_Q = 300 \text{ mA}$<br>$V_{dr} = V_I - V_Q^{1)}$  |
| 5.1.6           | Dropout Voltage | $V_{dr}$ | –            | 1.0  | 2.0  | V    | IFX25001 ME V25,<br>$I_Q = 300 \text{ mA}$<br>$V_{dr} = V_I - V_Q^{1)}$  |



**Electrical Characteristics**
 $V_I = 13.5 \text{ V}$ ;  $T_j = -40 \text{ }^\circ\text{C}$  to  $125 \text{ }^\circ\text{C}$ ; all voltages with respect to ground (unless otherwise specified)

| Pos.   | Parameter                                      | Symbol             | Limit Values |      |      | Unit             | Measuring Condition  |
|--------|--|--------------------|--------------|------|------|------------------|--|
|        |  |                    | Min.         | Typ. | Max. |                  |  |
| 5.1.7  | Load Regulation                                | $\Delta V_{Q, lo}$ | –            | 20   | 50   | mV               | IFX25001 TS V50,<br>IFX25001TF V50,<br>IFX25001 TC V50,<br>$I_Q = 5 \text{ mA}$ to $400 \text{ mA}$<br>$V_I = 6 \text{ V}$ |
| 5.1.8  | Load Regulation                                | $\Delta V_{Q, lo}$ | –            | 20   | 50   | mV               | IFX25001 TS V85,<br>IFX25001 TC V85<br>IFX25001 TS V10,<br>IFX25001 TC V10<br>$I_Q = 5 \text{ mA}$ to $400 \text{ mA}$     |
| 5.1.9  | Load Regulation                                | $\Delta V_{Q, lo}$ | –            | 40   | 70   | mV               | IFX25001 ME V33,<br>IFX25001 TF V33,<br>IFX25001 ME V25<br>$I_Q = 5 \text{ mA}$ to $300 \text{ mA}$<br>$V_I = 6 \text{ V}$ |
| 5.1.10 | Line Regulation                                | $\Delta V_{Q, li}$ | –            | 10   | 25   | mV               | $V_I = 12 \text{ V}$ to $32 \text{ V}$<br>$I_Q = 5 \text{ mA}$   |
| 5.1.11 | Output Current Limitation                      | $I_Q$              | 400          | 600  | 1100 | mA               | <sup>1)</sup>  |
| 5.1.12 | Power Supply Ripple Rejection <sup>2)</sup>    | $PSRR$             | –            | 60   | –    | dB               | $f_r = 100 \text{ Hz}$ ; $V_r = 0.5 \text{ Vpp}$   |
| 5.1.13 | Temperature Output Voltage Drift <sup>2)</sup> | $\frac{dV_Q}{dT}$  | –            | 0.5  | –    | mV/K             | –  |
| 5.1.14 | Overtemperature Shutdown Threshold             | $T_{j, sd}$        | 151          | –    | 200  | $^\circ\text{C}$ | $T_j$ increasing <sup>2)</sup>   |

**Current Consumption**

|        |  |       |   |     |     |               |                        |
|--------|--|-------|---|-----|-----|---------------|------------------------|
| 5.1.15 | Quiescent Current<br>$I_q = I_I - I_Q$ | $I_q$ | – | 100 | 220 | $\mu\text{A}$ | $I_Q = 1 \text{ mA}$   |
| 5.1.16 | Current Consumption                    | $I_q$ | – | 8   | 15  | mA            | $I_Q = 250 \text{ mA}$ |
| 5.1.17 | $I_q = I_I - I_Q$                      | $I_q$ | – | 20  | 30  | mA            | $I_Q = 400 \text{ mA}$ |

1) Measured when the output voltage  $V_Q$  has dropped 100 mV from the nominal value obtained at  $V_I = 13.5 \text{ V}$ .

2) not subject to production test, specified by design



### 5.2 Typical Performance Characteristics Voltage Regulator (V50, V85, V10)

Dropout Voltage  $V_{dr}$  versus Output Current  $I_Q$

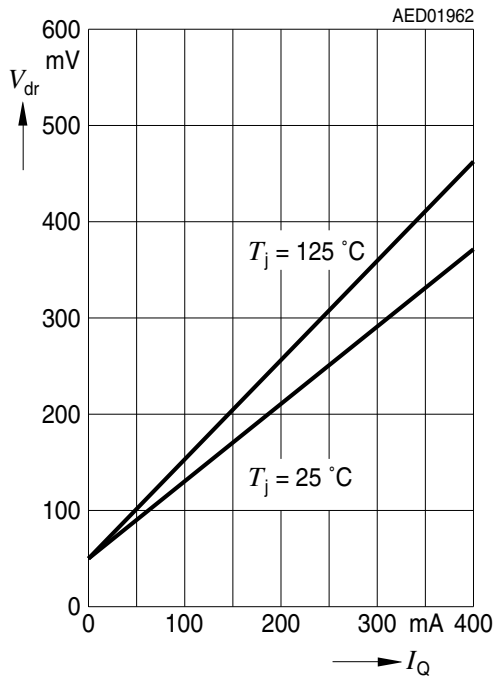

Output Current  $I_Q$  versus Input Voltage  $V_I$

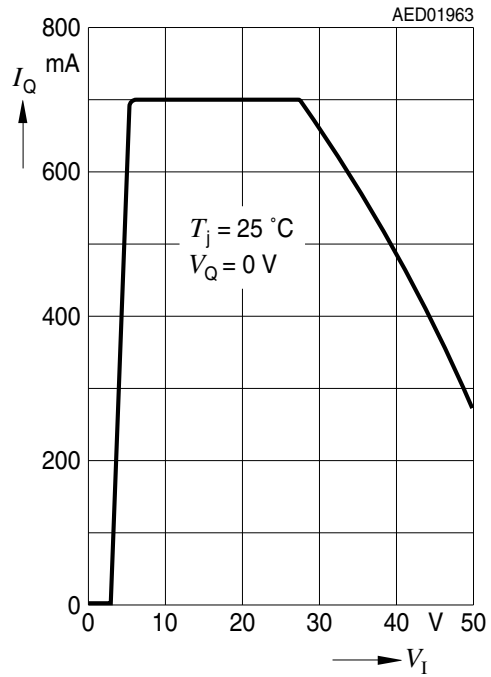

Current Consumption  $I_q$  versus Output Current  $I_Q$  (High Load)

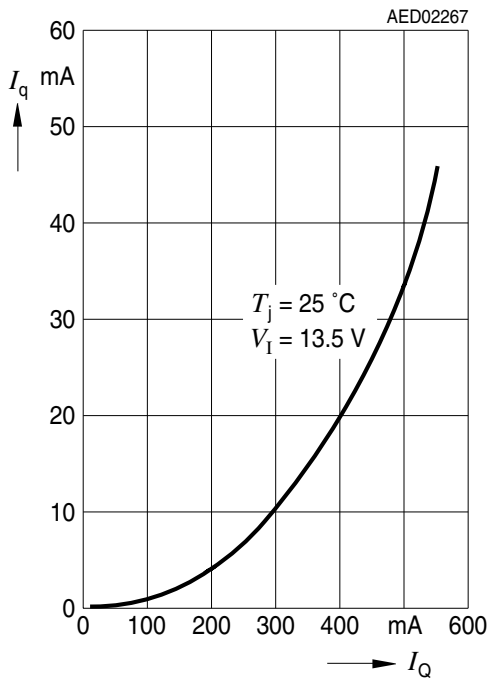

Current Consumption  $I_q$  versus Output Current  $I_Q$  (Low Load)

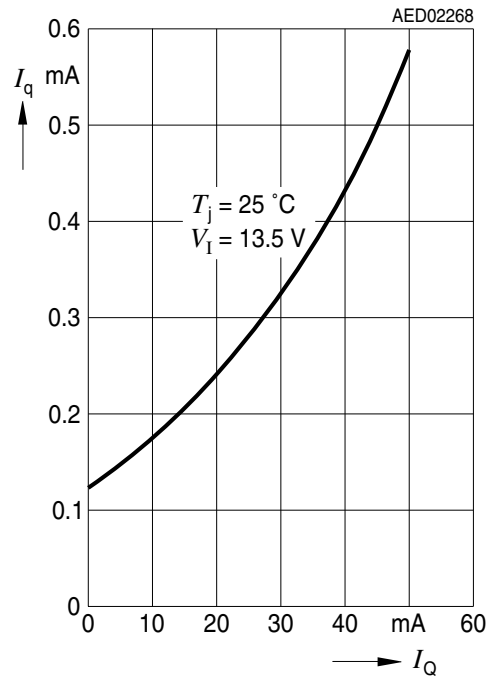

### 5.2.1 Typical Performance Characteristics Voltage Regulator (V50 Version)

Output Voltage  $V_Q$  versus Junction Temperature  $T_j$

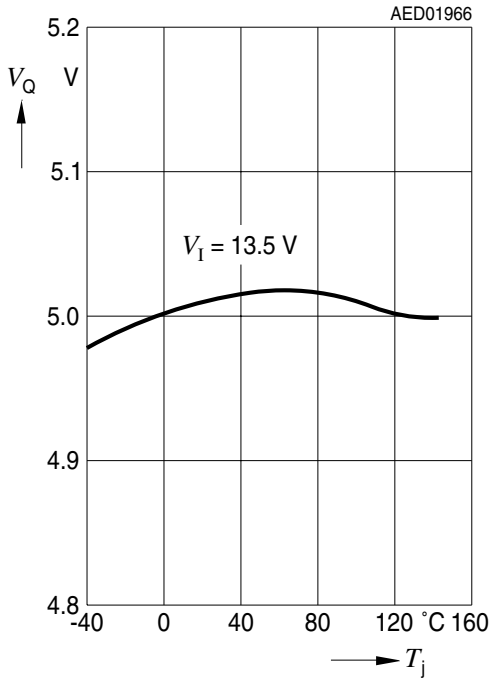

Current Consumption  $I_q$  versus Input Voltage  $V_I$

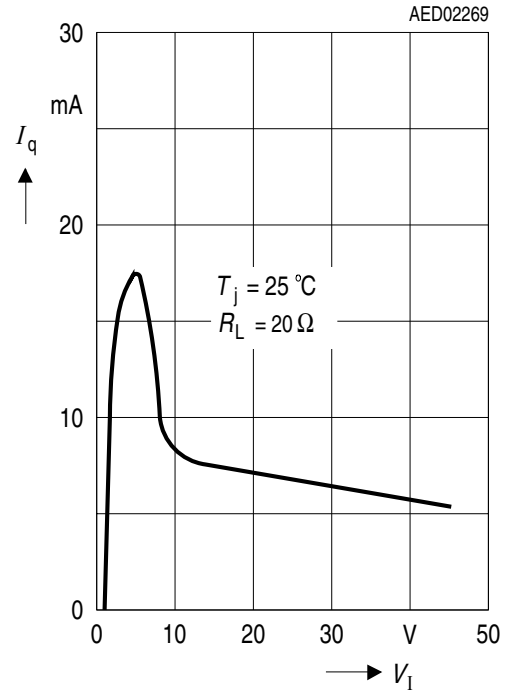

Output Voltage  $V_Q$  versus Input Voltage  $V_I$

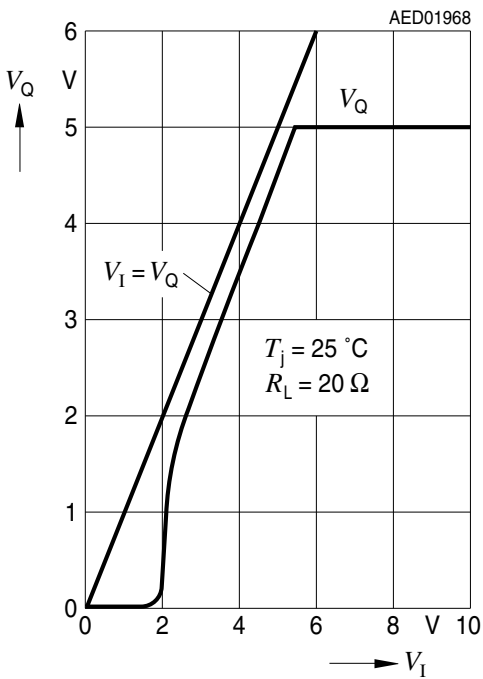

Input Current  $I_I$  versus Input Voltage  $V_I$

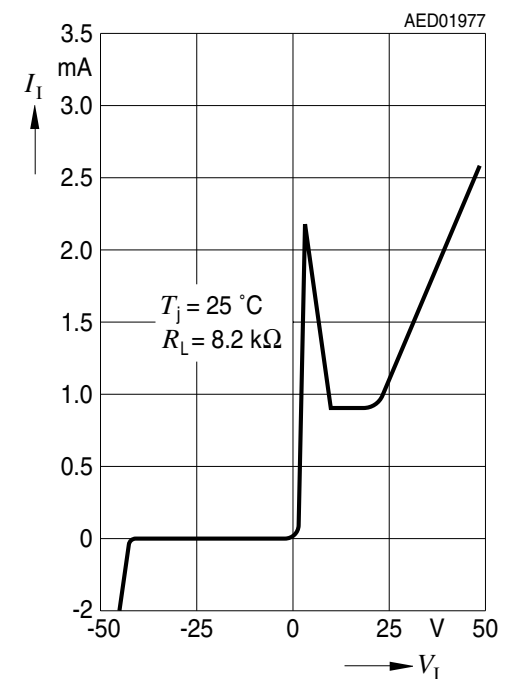

### 5.2.2 Typical Performance Characteristics Voltage Regulator (V85 Version)

Output Voltage  $V_Q$  versus Junction Temperature  $T_j$

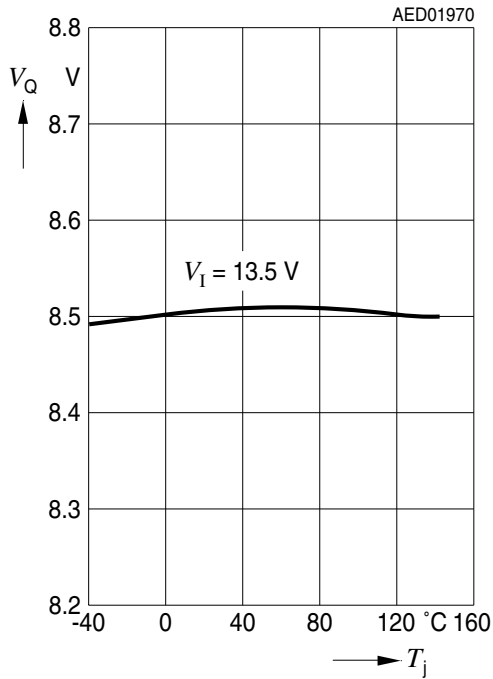

Current Consumption  $I_q$  versus Input Voltage  $V_I$

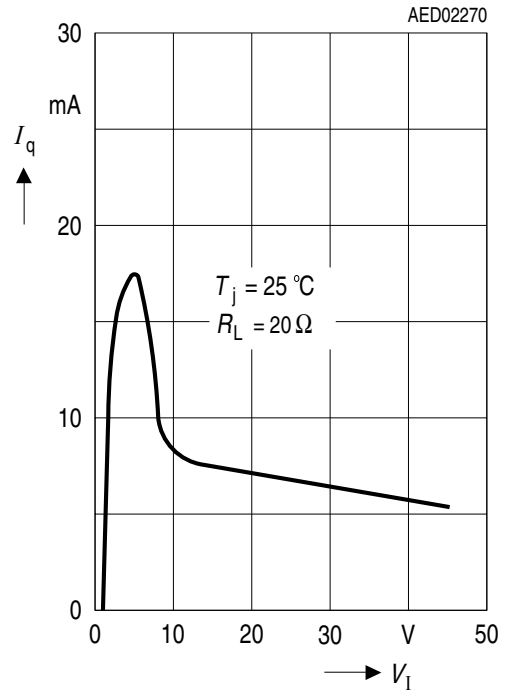

Output Voltage  $V_Q$  versus Input Voltage  $V_I$

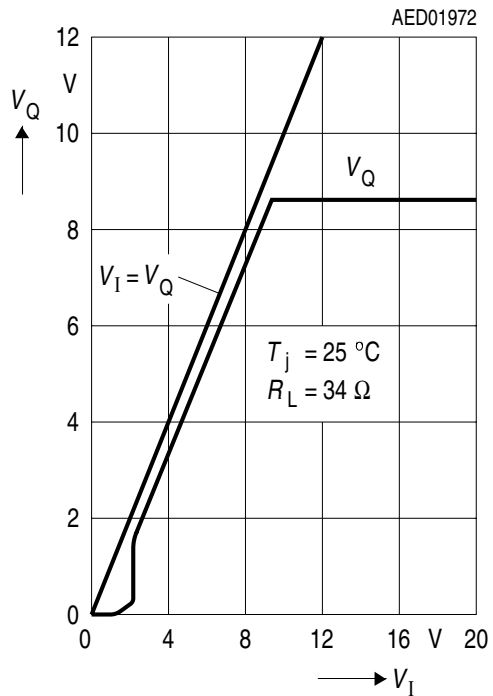

Input Current  $I_I$  versus Input Voltage  $V_I$

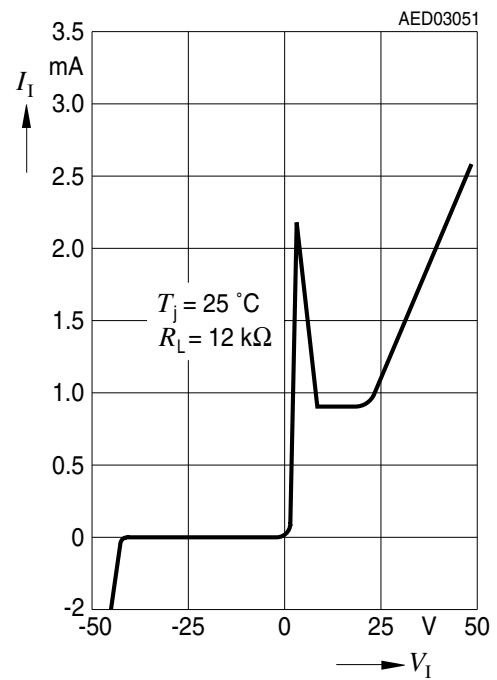

### 5.2.3 Typical Performance Characteristics Voltage Regulator (V10 Version)

Output Voltage  $V_Q$  versus Junction Temperature  $T_j$

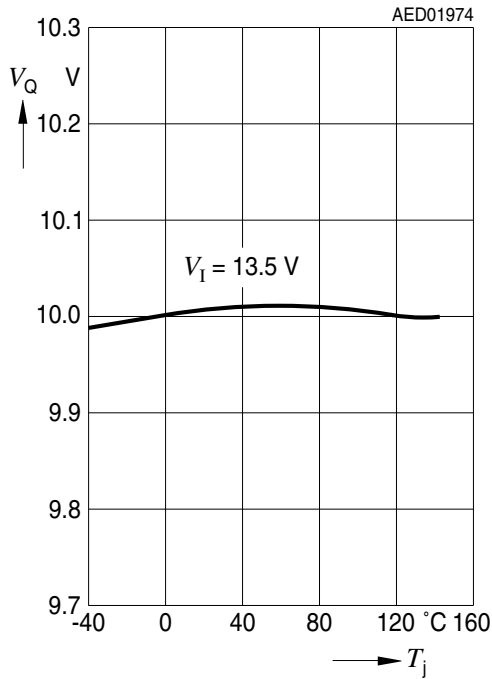

Current Consumption  $I_q$  versus Input Voltage  $V_I$

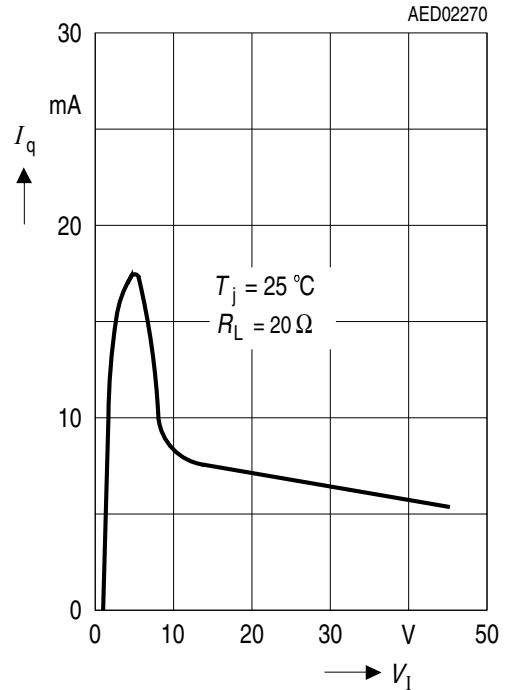

Output Voltage  $V_Q$  versus Input Voltage  $V_I$

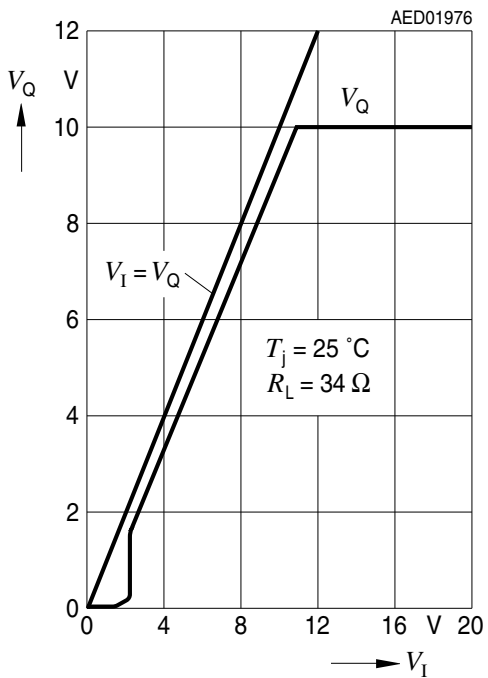

Input Current  $I_I$  versus Input Voltage  $V_I$

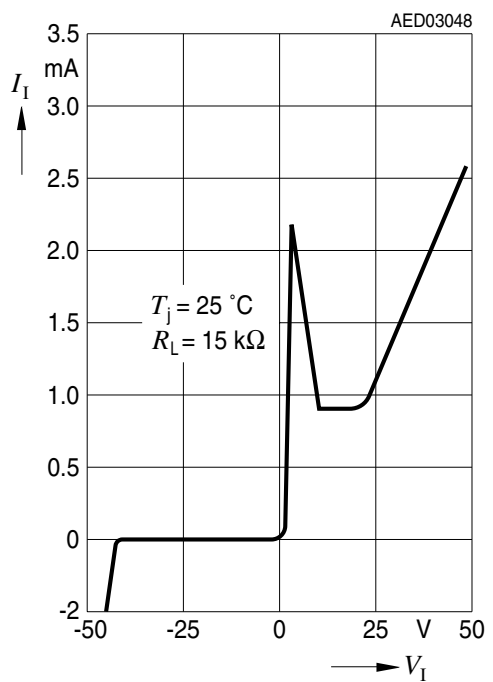

5.2.4 Typical Performance Characteristics Voltage Regulator (V33 and V25 Version)

Output Voltage  $V_Q$  versus Junction Temperature  $T_j$  (V33 Version)

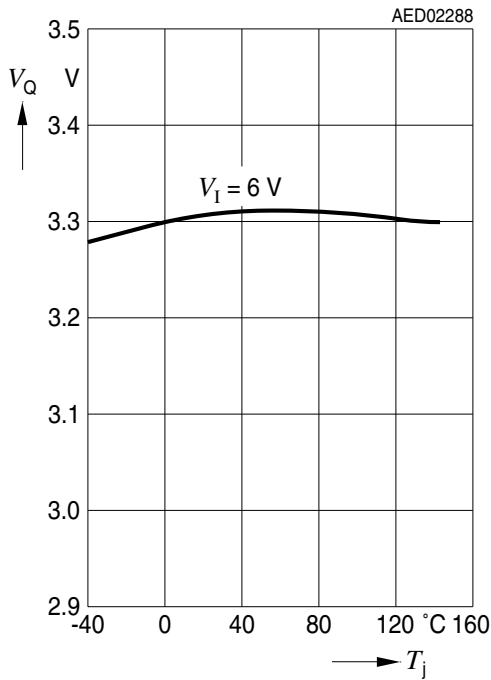

Output Voltage  $V_Q$  versus Junction Temperature  $T_j$  (V25 Version)

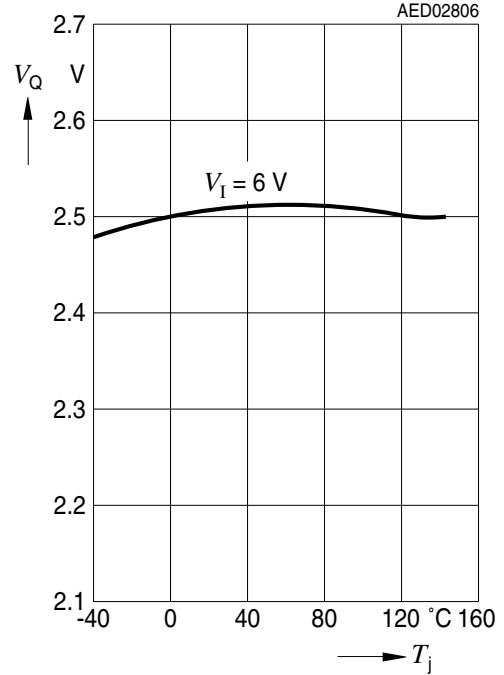

Input Current  $I_I$  versus Input Voltage  $V_I$  (V33 Version)

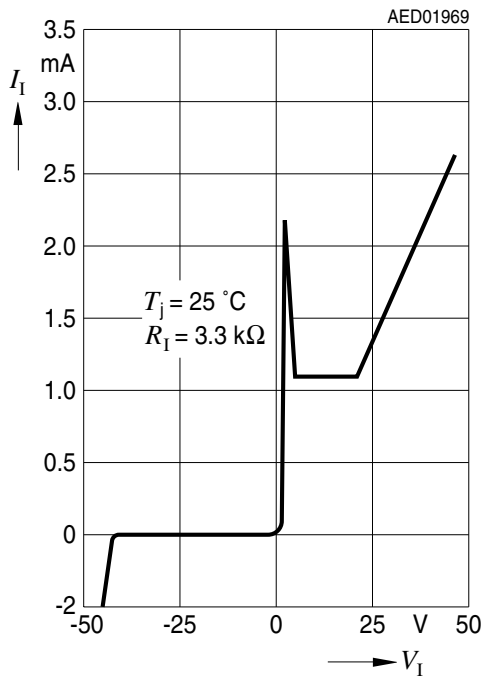

Input Current  $I_I$  versus Input Voltage  $V_I$  (V25 Version)

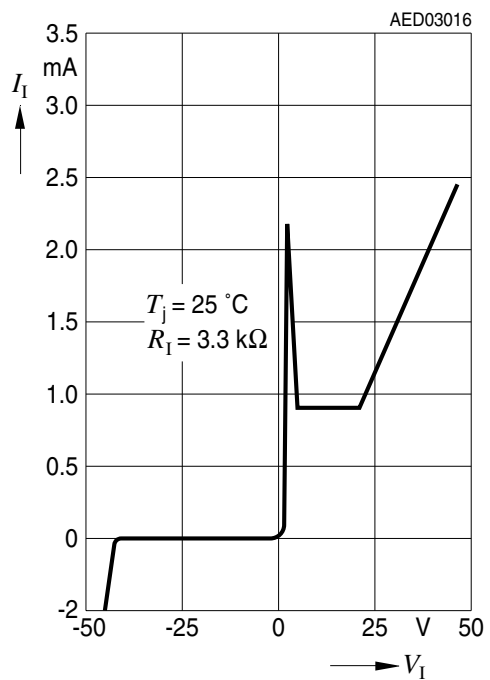

### 5.2.5 Typical Performance Characteristics Voltage Regulator (V33 and V25 Version)

Current Consumption  $I_q$  versus Output Current  $I_Q$  (Low Load)

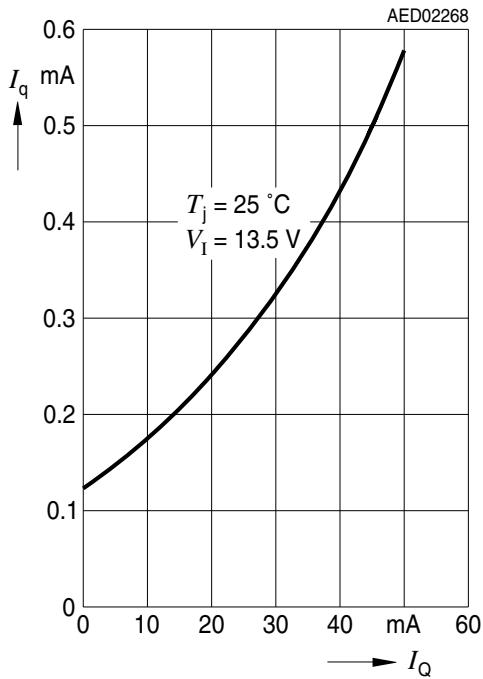

Current Consumption  $I_q$  versus Output Current  $I_Q$  (High Load)

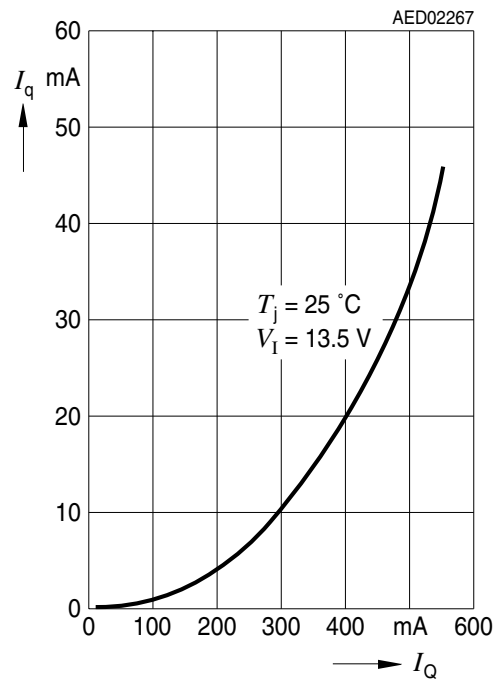

Output Current  $I_Q$  versus Input Voltage  $V_I$

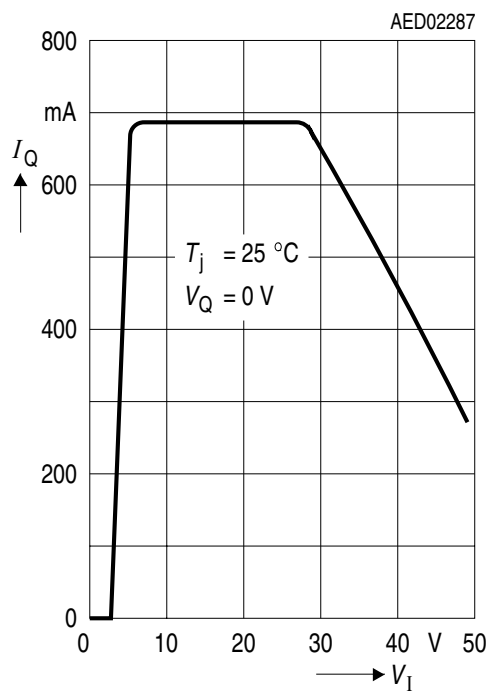

Region of Stability For Output Capacitor,  $C_Q = 10 \mu\text{F}$

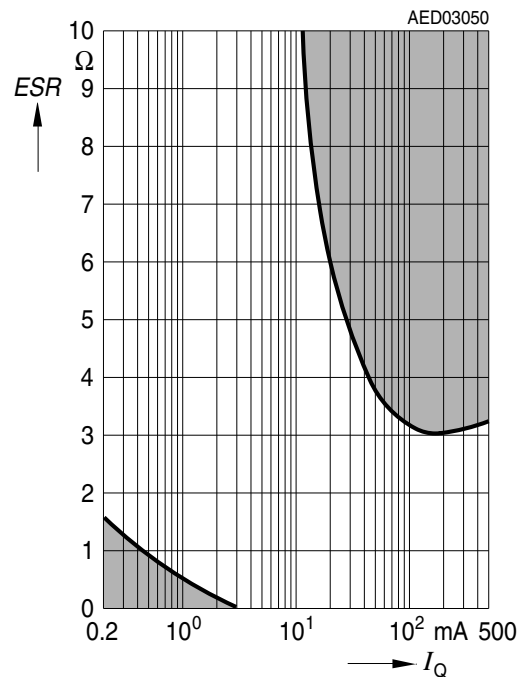

6 Package Outlines

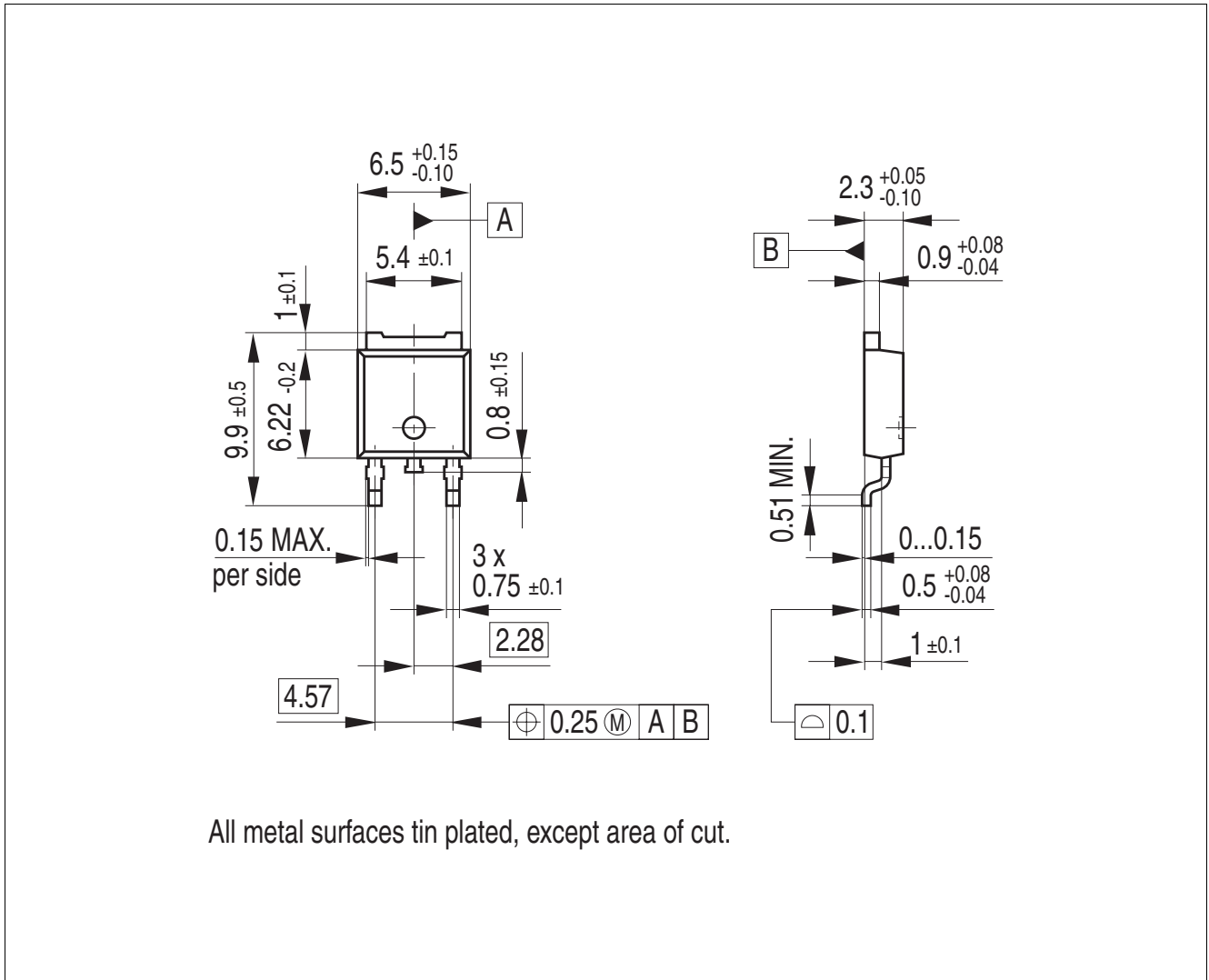

Figure 3 PG-TO252-3



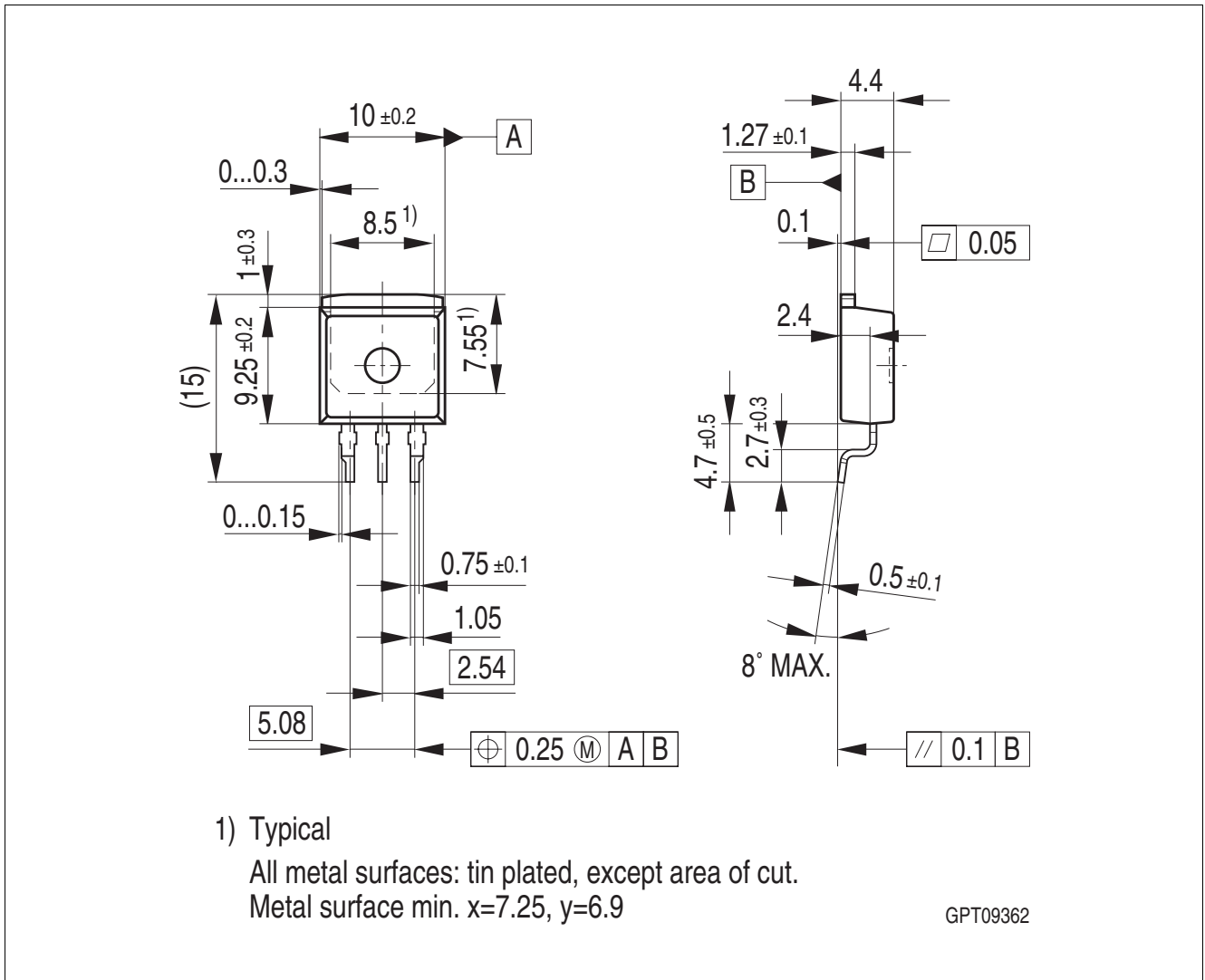

Figure 4 PG-TO263-3

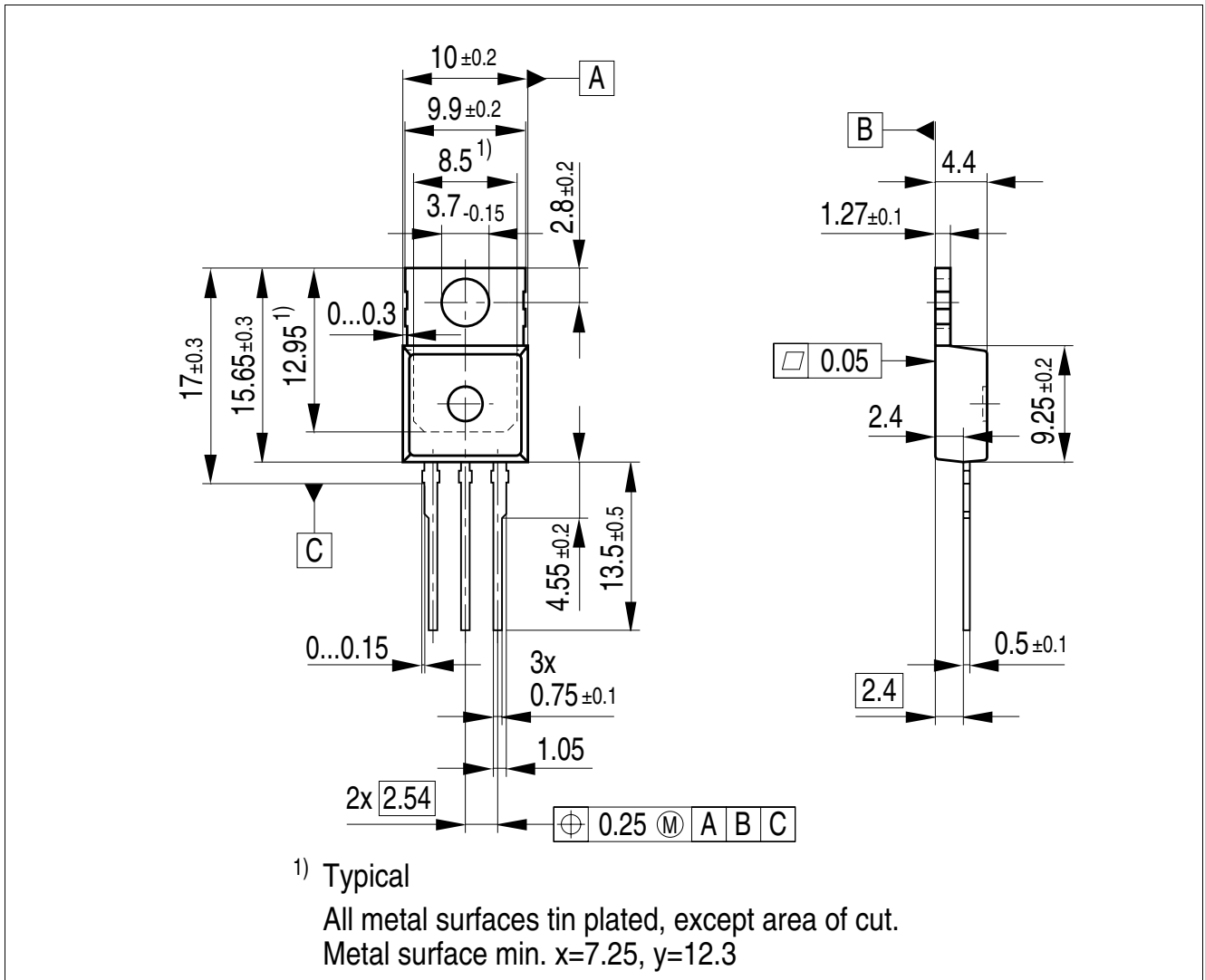

Figure 5 PG-TO220-3

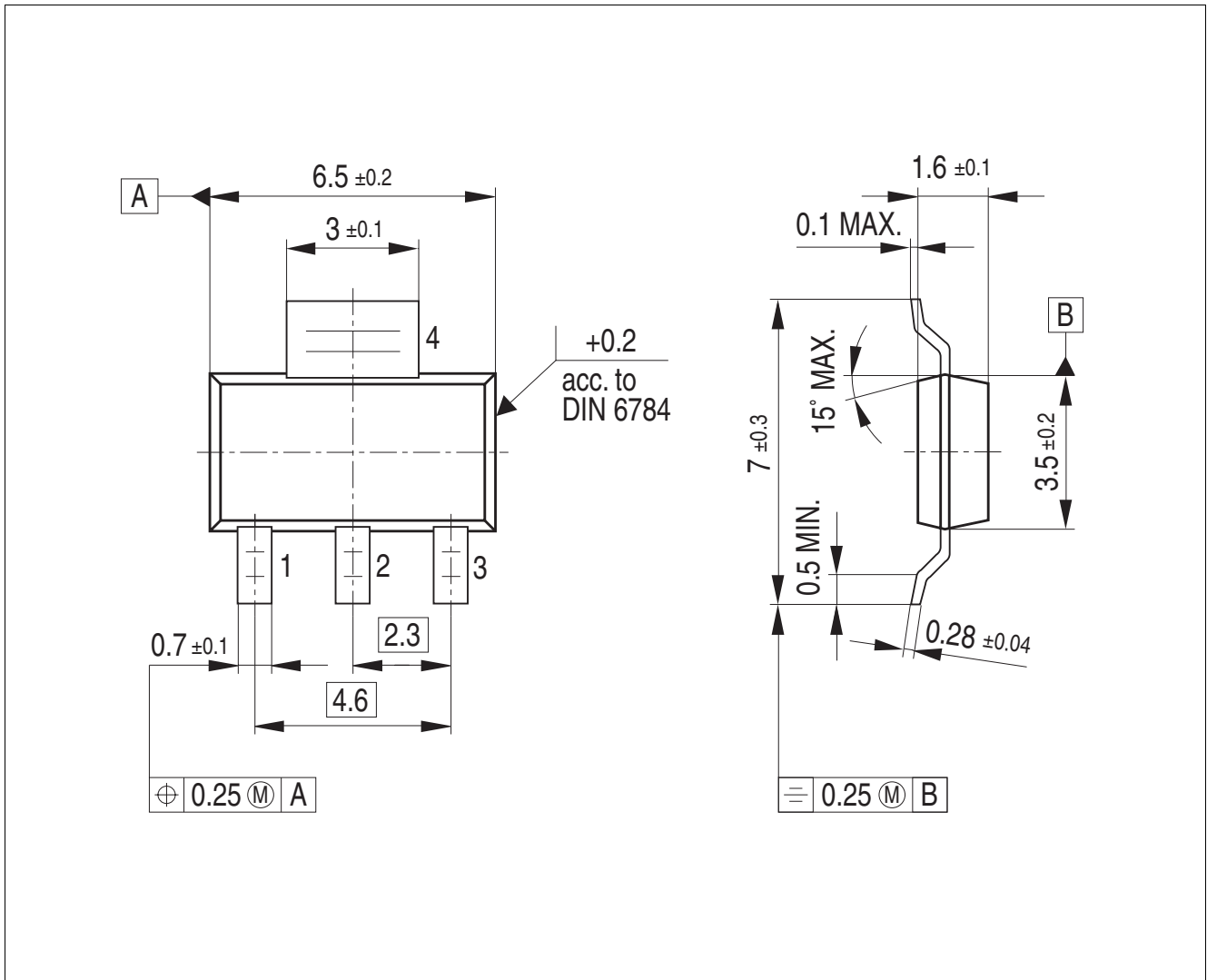

Figure 6 PG-SOT223-4

**Green Product (RoHS compliant)**

To meet the world-wide customer requirements for environmentally friendly products and to be compliant with government regulations the device is available as a green product. Green products are RoHS-Compliant (i.e. Pb-free finish on leads and suitable for Pb-free soldering according to IPC/JEDEC J-STD-020).

For further information on packages, please visit our website:  
<http://www.infineon.com/packages>.

Dimensions in mm

## 7 Revision History

| Revision | Date       | Changes   |
|----------|------------|---|
| 1.02     | 2009-05-20 | Editorial change (fig. 2)   |
| 1.01     | 2009-10-02 | Coverpage changed<br>Overview page: Inserted reference statement to TLE/TLF series. |
| 1.0      | 2009-04-28 | Initial Release   |

**Edition 2010-05-20**

**Published by  
Infineon Technologies AG  
81726 Munich, Germany**

**© 2010 Infineon Technologies AG  
All Rights Reserved.**

### **Legal Disclaimer**

The information given in this document shall in no event be regarded as a guarantee of conditions or characteristics. With respect to any examples or hints given herein, any typical values stated herein and/or any information regarding the application of the device, Infineon Technologies hereby disclaims any and all warranties and liabilities of any kind, including without limitation, warranties of non-infringement of intellectual property rights of any third party.

### **Information**

For further information on technology, delivery terms and conditions and prices, please contact the nearest Infineon Technologies Office ([www.infineon.com](http://www.infineon.com)).

### **Warnings**

Due to technical requirements, components may contain dangerous substances. For information on the types in question, please contact the nearest Infineon Technologies Office.

Infineon Technologies components may be used in life-support devices or systems only with the express written approval of Infineon Technologies, if a failure of such components can reasonably be expected to cause the failure of that life-support device or system or to affect the safety or effectiveness of that device or system. Life support devices or systems are intended to be implanted in the human body or to support and/or maintain and sustain and/or protect human life. If they fail, it is reasonable to assume that the health of the user or other persons may be endangered.