



GaAs PHEMT MMIC MEDIUM POWER AMPLIFIER, 12 - 30 GHz

Typical Applications

The HMC383LC4 is ideal for:

- Point-to-Point Radios
- Point-to-Multi-Point Radios & VSAT
- Test Equipment & Sensors
- LO Driver for HMC Mixers
- Military & Space

Features

- Gain: 15 dB
- Saturated Output Power: +18 dBm
- Output IP3: +25 dBm
- Single Positive Supply: +5V @ 100 mA
- 50 Ohm Matched Input/Output
- RoHS Compliant 4x4 mm Package

Functional Diagram

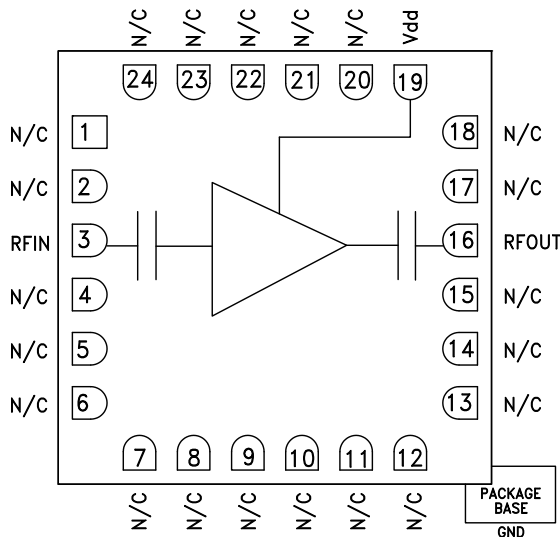

General Description

The HMC383LC4 is a general purpose GaAs PHEMT MMIC Driver Amplifier housed in a leadless RoHS compliant SMT package. The amplifier provides 15 dB of gain and +18 dBm of saturated power from a single +5V supply. Consistent gain and output power across the operating band make it possible to use a common driver/LO amplifier approach in multiple radio bands. The RF I/Os are DC blocked and matched to 50 Ohms for ease of use. The HMC383LC4 is housed in a RoHS compliant leadless 4x4 mm package allowing the use of surface mount manufacturing techniques.

Electrical Specifications, $T_A = +25^\circ C$, $V_{dd} = +5V$

| Parameter | Min. | Typ. | Max. | Min. | Typ. | Max. | Min. | Typ. | Max. | Min. | Typ. | Max. | Units |
|--|---------|------|------|---------|------|------|---------|------|------|---------|------|------|--------|
| Frequency Range | 12 - 16 | | | 16 - 24 | | | 24 - 28 | | | 28 - 30 | | | GHz |
| Gain | 12 | 15 | | 13 | 16 | | 12 | 15 | | 10 | 13 | | dB |
| Gain Variation Over Temperature | | 0.02 | 0.03 | | 0.02 | 0.03 | | 0.02 | 0.03 | | 0.02 | 0.03 | dB/ °C |
| Input Return Loss | | 14 | | | 14 | | | 11 | | | 13 | | dB |
| Output Return Loss | | 14 | | | 17 | | | 10 | | | 8 | | dB |
| Output Power for 1 dB Compression (P1dB) | 12 | 15 | | 13.5 | 16.5 | | 13 | 16 | | 12 | 15 | | dBm |
| Saturated Output Power (Psat) | | 17 | | | 18 | | | 17 | | | 16 | | dBm |
| Output Third Order Intercept (IP3) | | 24 | | | 25 | | | 25 | | | 23 | | dBm |
| Noise Figure | | 10.5 | | | 8 | | | 7.5 | | | 8 | | dB |
| Supply Current (I _{dd}) | 75 | 100 | 135 | 75 | 100 | 135 | 75 | 100 | 135 | 75 | 100 | 135 | mA |

Information furnished by Analog Devices is believed to be accurate and reliable. However, no responsibility is assumed by Analog Devices for its use, nor for any infringements of patents or other rights of third parties that may result from its use. Specifications subject to change without notice. No license is granted by implication or otherwise under any patent or patent rights of Analog Devices. Trademarks and registered trademarks are the property of their respective owners.

For price, delivery, and to place orders: Analog Devices, Inc., One Technology Way, P.O. Box 9106, Norwood, MA 02062-9106
 Phone: 781-329-4700 • Order online at www.analog.com
 Application Support: Phone: 1-800-ANALOG-D



**GaAs PHEMT MMIC MEDIUM
POWER AMPLIFIER, 12 - 30 GHz**

Broadband Gain & Return Loss

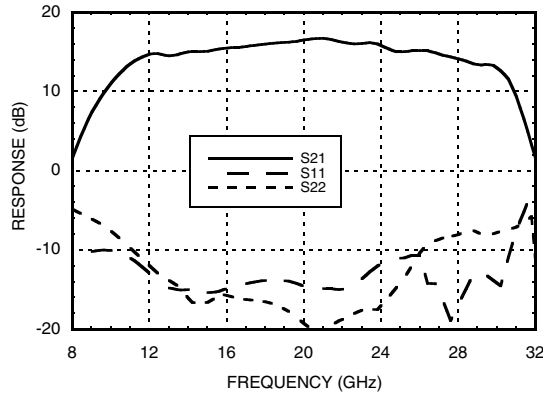

Gain vs. Temperature

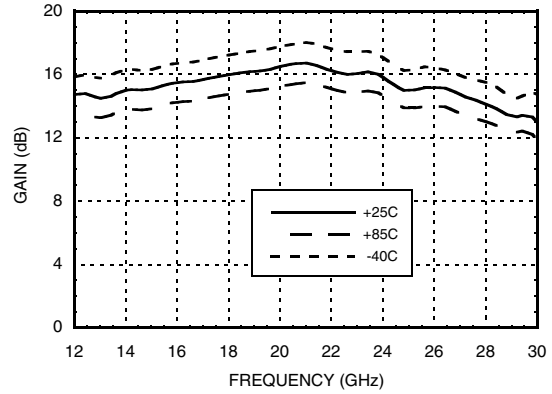

Input Return Loss vs. Temperature

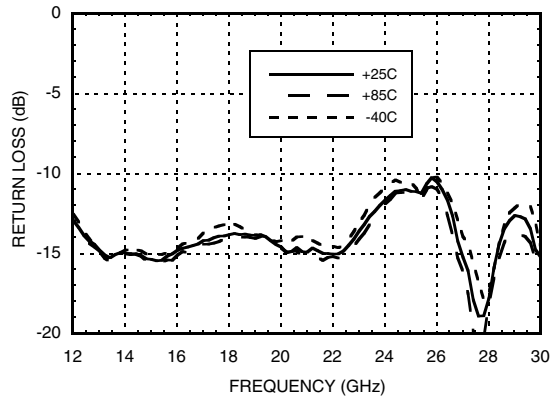

Output Return Loss vs. Temperature

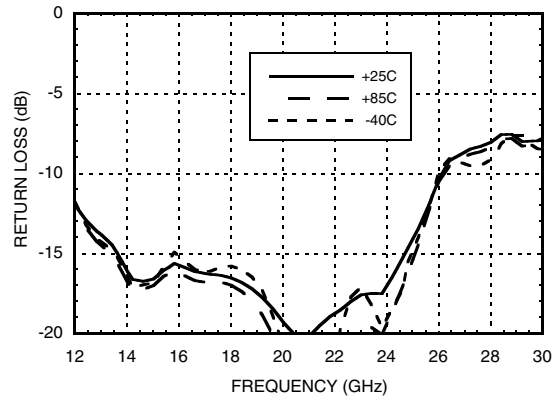

P1dB vs. Temperature

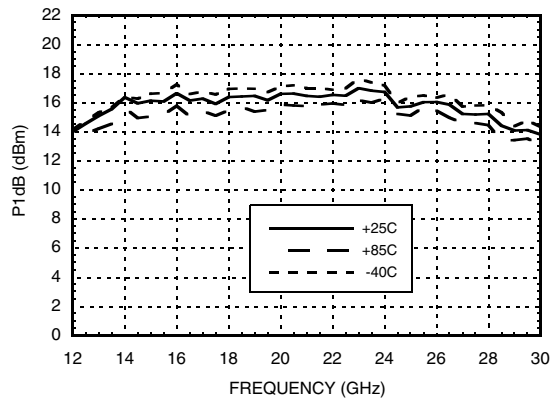

Psat vs. Temperature

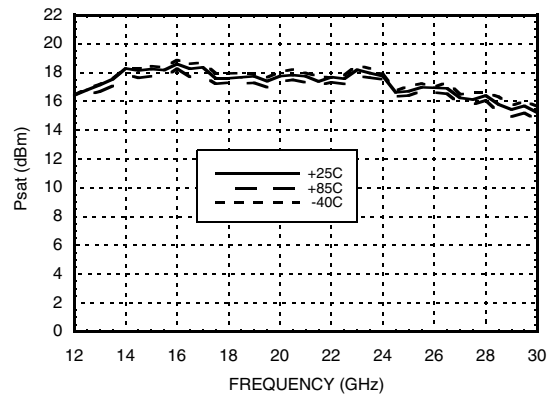



GaAs PHEMT MMIC MEDIUM POWER AMPLIFIER, 12 - 30 GHz

Power Compression @ 18 GHz

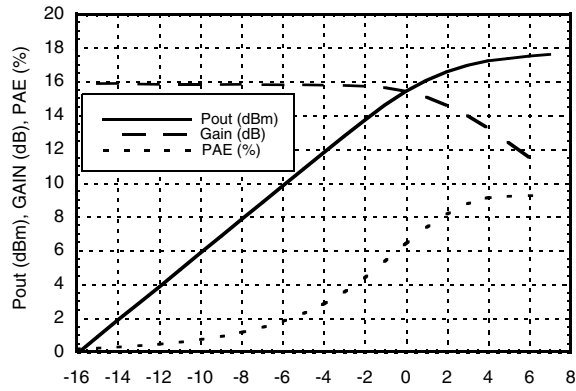

Power Compression @ 30 GHz

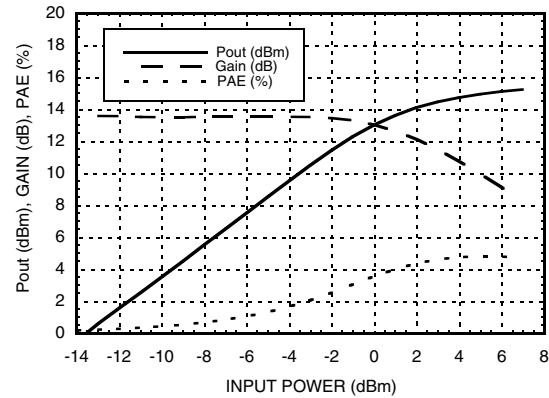

Output IP3 vs. Temperature

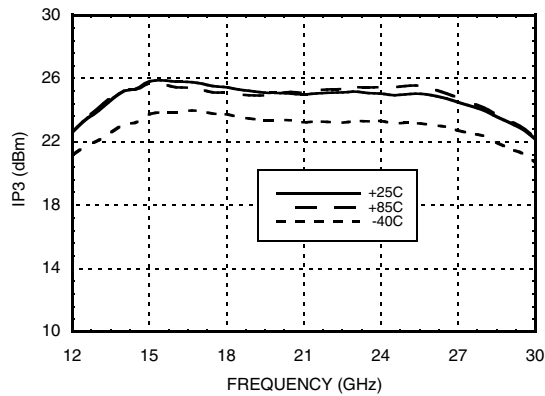

Noise Figure vs. Temperature

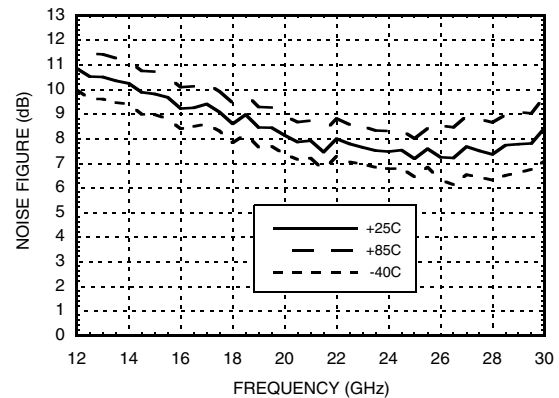

Gain & Power vs. Supply Voltage @ 18 GHz

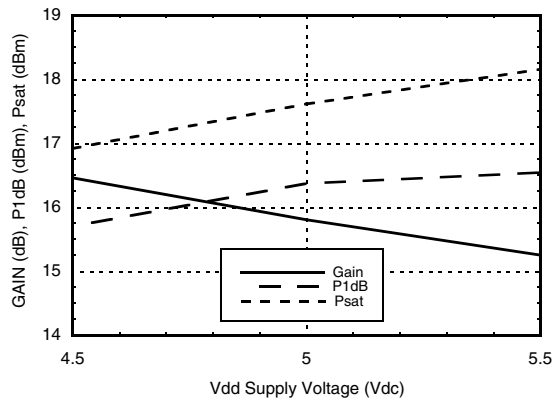

Reverse Isolation vs. Temperature

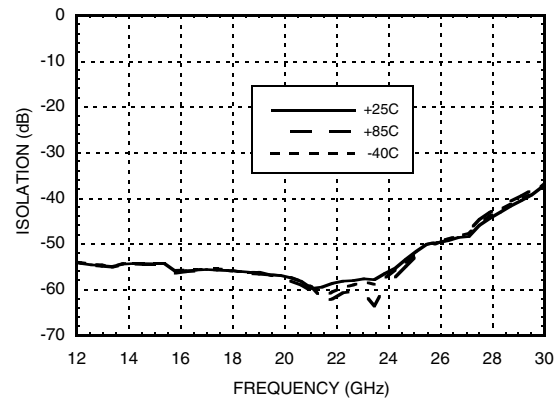

Information furnished by Analog Devices is believed to be accurate and reliable. However, no responsibility is assumed by Analog Devices for its use, nor for any infringements of patents or other rights of third parties that may result from its use. Specifications subject to change without notice. No license is granted by implication or otherwise under any patent or patent rights of Analog Devices. Trademarks and registered trademarks are the property of their respective owners.

For price, delivery, and to place orders: Analog Devices, Inc., One Technology Way, P.O. Box 9106, Norwood, MA 02062-9106 Phone: 781-329-4700 • Order online at www.analog.com Application Support: Phone: 1-800-ANALOG-D



GaAs PHEMT MMIC MEDIUM POWER AMPLIFIER, 12 - 30 GHz

Absolute Maximum Ratings

| | |
|--|----------------|
| Drain Bias Voltage (Vdd) | +5.5 Vdc |
| RF Input Power (RFIN)(Vdd = +5Vdc) | +10 dBm |
| Channel Temperature | 175 °C |
| Continuous Pdiss (T= 85 °C) (derate 10 mW/°C above 85 °C) | 0.92 W |
| Thermal Resistance (channel to ground paddle) | 98 °C/W |
| Storage Temperature | -65 to +150 °C |
| Operating Temperature | -40 to +85 °C |
| ESD Sensitivity (HBM) | Class 1A |

Typical Supply Current vs. Vdd

| Vdd (V) | Idd (mA) |
|---------|----------|
| +4.5 | 99 |
| +5.0 | 100 |
| +5.5 | 101 |

Note: Amplifier will operate over full voltage ranges shown above



ELECTROSTATIC SENSITIVE DEVICE
OBSERVE HANDLING PRECAUTIONS

Outline Drawing

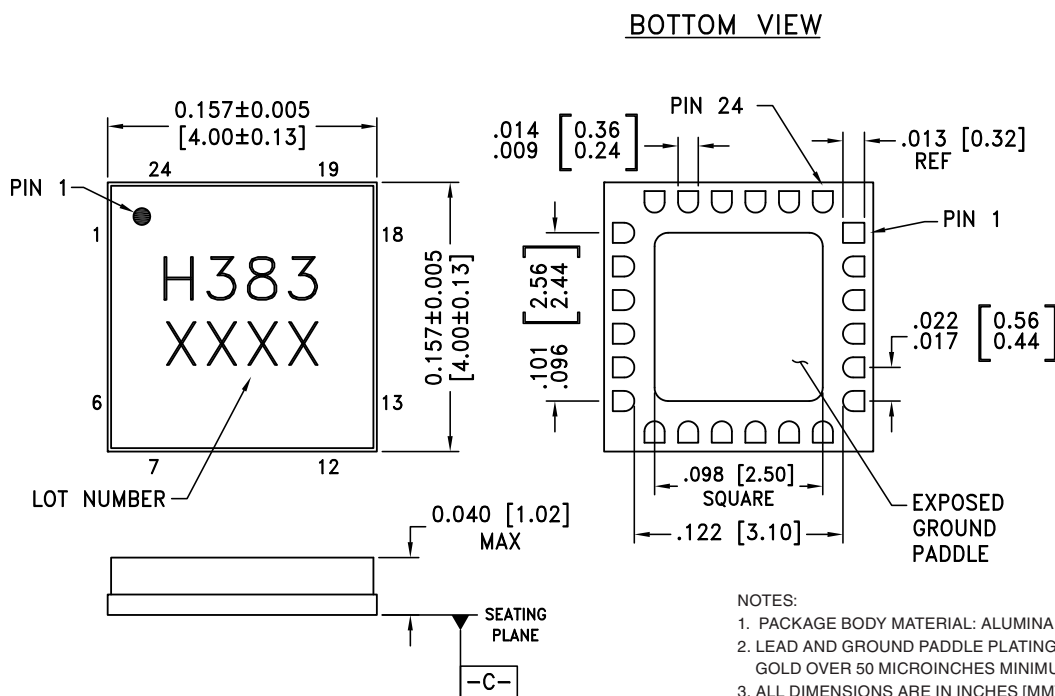

NOTES:

- PACKAGE BODY MATERIAL: ALUMINA
- LEAD AND GROUND PADDLE PLATING: 30-80 MICROINCHES GOLD OVER 50 MICROINCHES MINIMUM NICKEL.
- ALL DIMENSIONS ARE IN INCHES [MM]
- LEAD SPACING TOLERANCE IS NON-CUMULATIVE
- PACKAGE WARP SHALL NOT EXCEED 0.05mm DATUM -C-
- ALL GROUND LEADS AND GROUND PADDLE MUST BE SOLDERED TO PCB RF GROUND

Package Information

| Part Number | Package Body Material | Lead Finish | MSL Rating | Package Marking ^[2] |
|-------------|-----------------------|------------------|---------------------|--------------------------------|
| HMC383LC4 | Alumina, White | Gold over Nickel | MSL3 ^[1] | H383 XXXX |

[1] Max peak reflow temperature of 260 °C

[2] 4-Digit lot number XXXX



GaAs PHEMT MMIC MEDIUM POWER AMPLIFIER, 12 - 30 GHz

Pin Descriptions

| Pin Number | Function | Description | Interface Schematic |
|-------------------------------|----------|---|---------------------|
| 1, 2, 4 - 15, 17, 18, 20 - 24 | N/C | No connection required. These pins may be connected to RF/DC ground without affecting performance if using grounded coplanar wave guide transmission lines. | |
| 3 | RFIN | This pad is AC coupled and matched to 50 Ohms. | |
| 16 | RFOUT | This pad is AC coupled and matched to 50 Ohms. | |
| 19 | Vdd | Power Supply Voltage for the amplifier. External bypass capacitors of 100 pF, 1,000 pF and 2.2 μF are required. | |
| | GND | Package base has an exposed metal ground that must be connected to RF/DC ground. Vias under the device are required | |

Application Circuit

| Component | Value |
|-----------|----------|
| C1 | 100 pF |
| C2 | 1,000 pF |
| C3 | 2.2 μF |

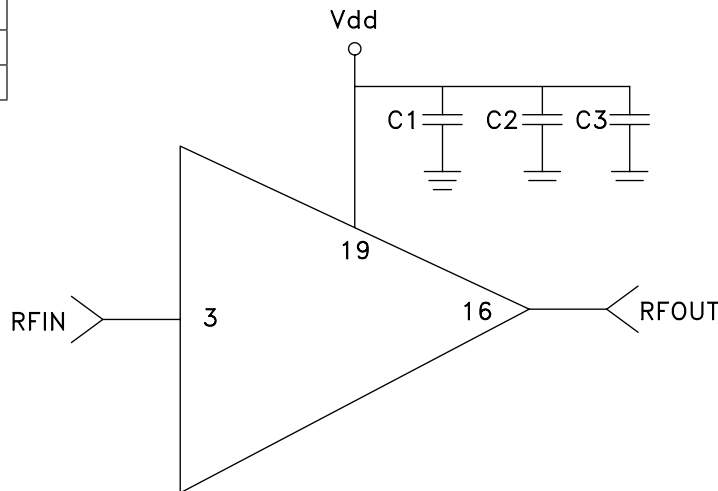



**GaAs PHEMT MMIC MEDIUM
POWER AMPLIFIER, 12 - 30 GHz**

Evaluation PCB

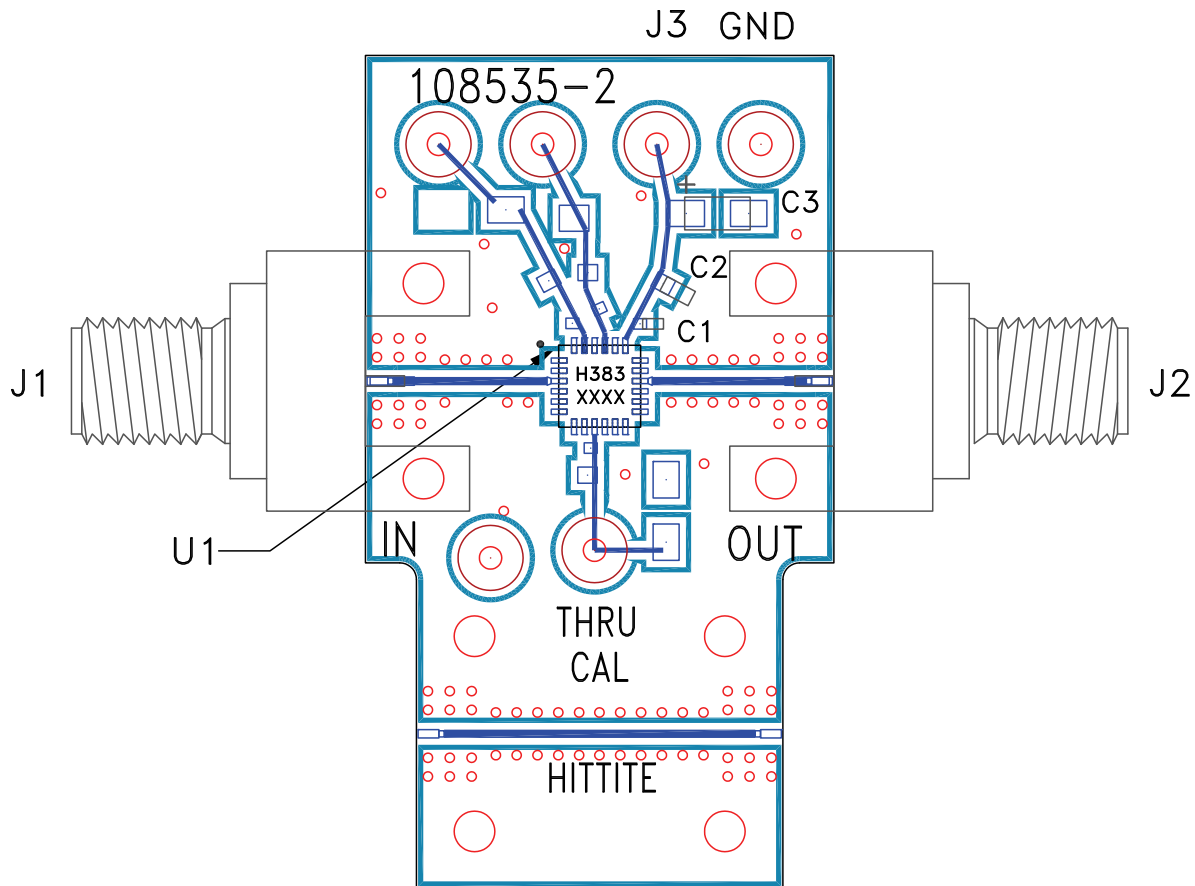

List of Materials for Evaluation PCB 122198 [1]

| Item | Description |
|---------|-------------------------------|
| J1, J2 | 2.92 mm PCB mount K-connector |
| J3, J4 | DC Pin |
| C1 | 100 pF capacitor, 0402 pkg. |
| C2 | 1,000 pF Capacitor, 0603 pkg. |
| C3 | 2.2µF Capacitor, Tantalum |
| U1 | HMC383LC4 Amplifier |
| PCB [2] | 108535 Evaluation PCB |

[1] Reference this number when ordering complete evaluation PCB

[2] Circuit Board Material: Rogers 4350.

The circuit board used in this application should use RF circuit design techniques. Signal lines should have 50 Ohm impedance while the package ground leads and exposed paddle should be connected directly to the ground plane similar to that shown. A sufficient number of via holes should be used to connect the top and bottom ground planes. The evaluation board should be mounted to an appropriate heat sink. The evaluation circuit board shown is available from Hittite upon request.