

## Features

- \* 1200W peak pulse power (8/20 $\mu$ s)
- \* Low leakage: nA level
- \* Low operating voltage: 5V
- \* Ultra Low Leakage:nA Level
- \* Ultra low clamping voltage
- \* One power line protects
- \* Complies with following standards:
  - IEC 61000-4-2 (ESD) immunity test
    - Air discharge:  $\pm 30$ kV
    - Contact discharge:  $\pm 30$ kV
  - IEC61000-4-5 (Lightning) 110A (8/20 $\mu$ s)
- \* RoHS Compliant

## Mechanical Characteristics

- \* Package: DFN1610-2
- \* Ultra low leakage: nA level
- \* Case Material: "Green" Molding Compound.
- \* UL Flammability Classification Rating 94V-0
- \* Moisture Sensitivity: Level 3 per J-STD-020

## Applications

- \* Power Management
- \* Industrial Application
- \* Power Supply Protection
- \* Many other portable devices

## Ordering Information

Part Number	Qty per Reel	Reel Size
ESDA7P60-1U1M	3000	7"

## Dimensions and Pin Configuration

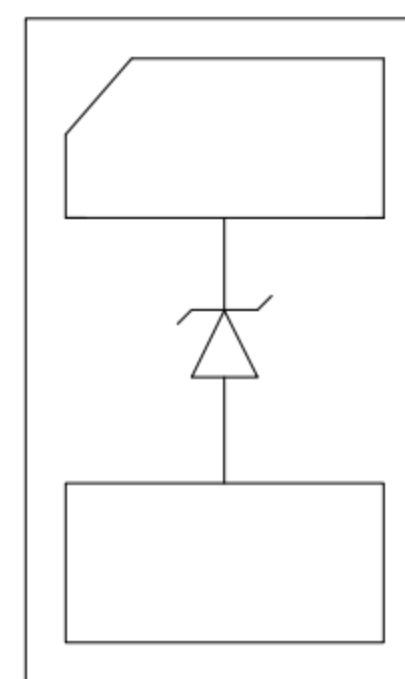
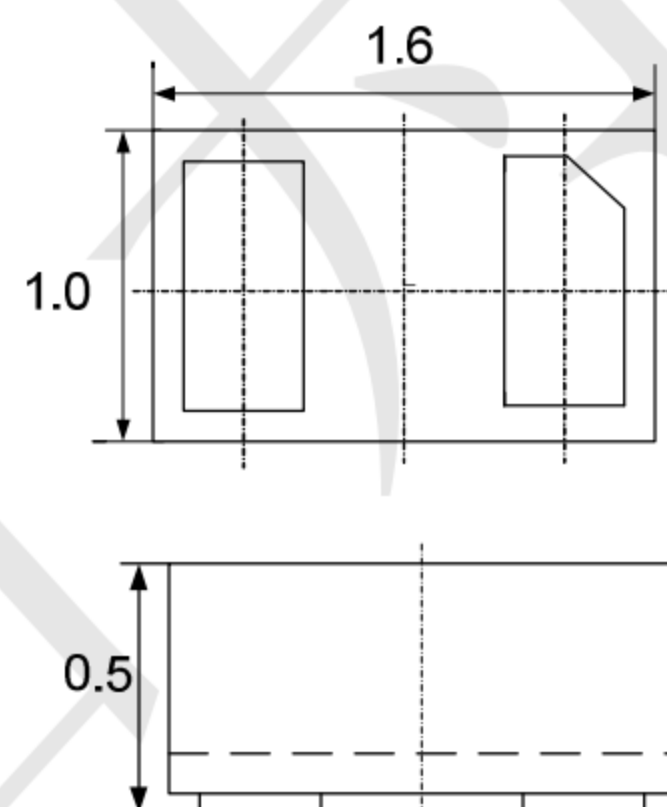

**Marking:5P**

**Absolute Maximum Ratings** (Tamb=25°C unless otherwise specified)

Parameter	Symbol	Value	Unit
Peak Pulse Power (8/20μs)	Ppk	1200	W
Peak Pulse Current (8/20μs)	Ipp	110	A
ESD per IEC 61000-4-2 (Air)	VESD	±30	kV
ESD per IEC 61000-4-2 (Contact)		±30	
Operating Temperature Range	TJ	-55 to +125	°C
Storage Temperature Range	Tstg	-55 to +150	°C

**Electrical Characteristics** (TA=25°C unless otherwise specified)

Parameter	Symbol	Min	Typ	Max	Unit	Test Condition
Reverse Working Voltage	VRWM			5	V	
Breakdown Voltage	VBR	5.6	6	7.6	V	IT = 1mA
Reverse Leakage Current	IR			1	uA	VRWM = 5V
Clamping Voltage	VC			8	V	Ipp=50A(8x 20us pulse)
Clamping Voltage	VC			11	V	Ipp=100A(8x 20us pulse)
Junction Capacitance	CJ			400	pF	VR = 0V, f = 1MHz

**Typical Performance Characteristics ( $T_A=25^\circ\text{C}$  unless otherwise Specified)**

Fig1. 8/20 $\mu\text{s}$  Pulse Waveform

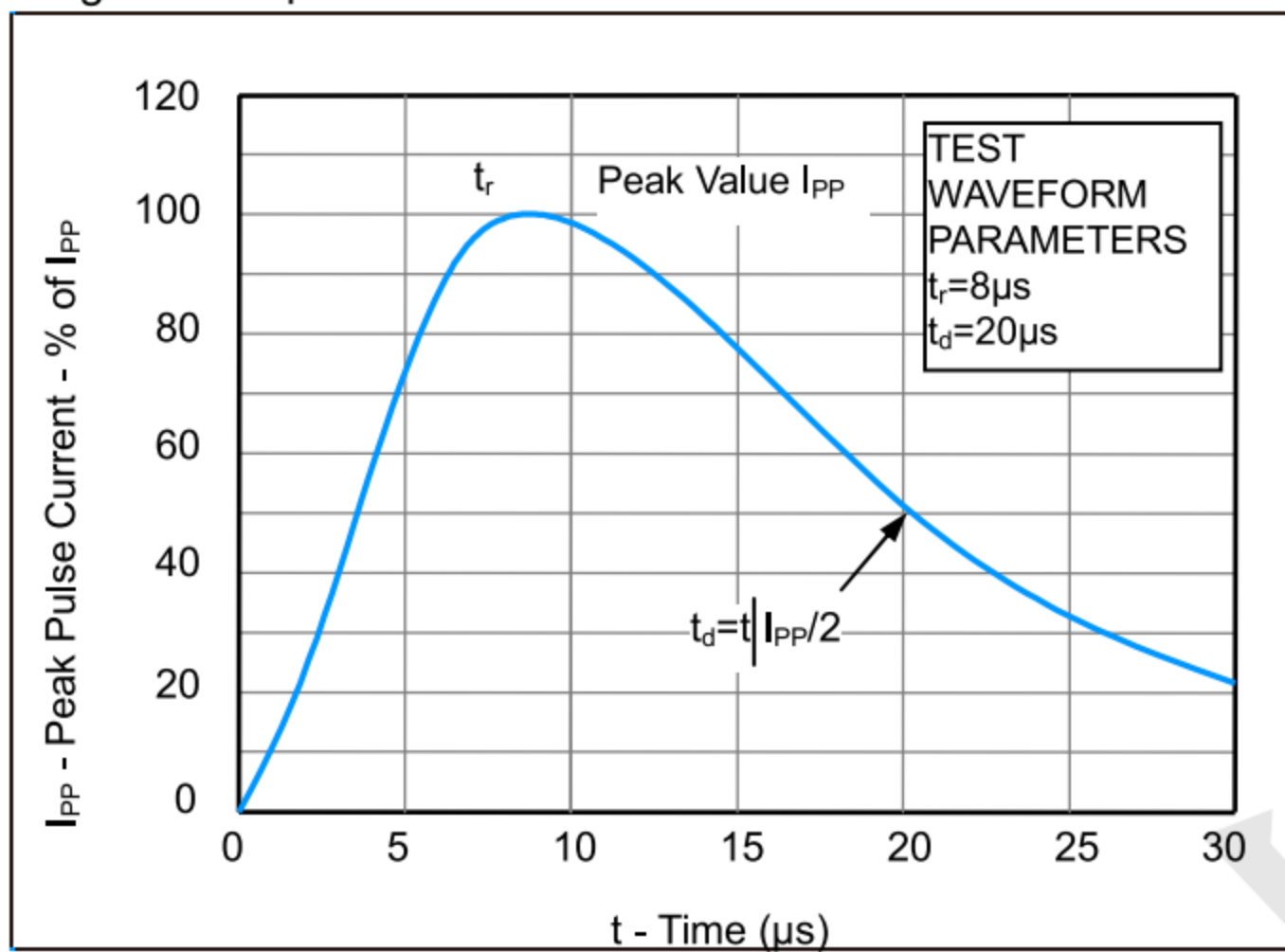

Fig2. ESD Pulse Waveform (according to IEC 61000-4-2)

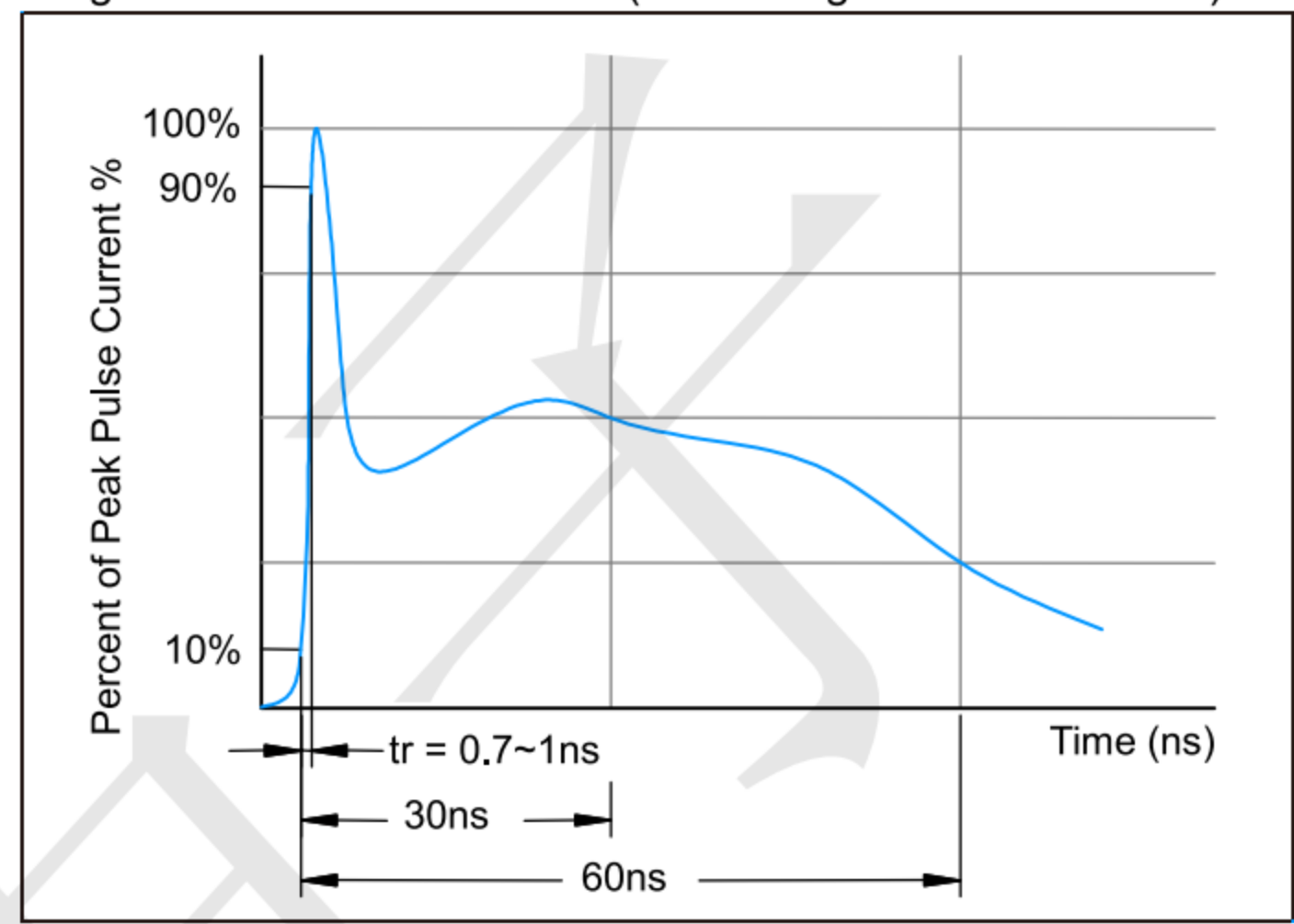
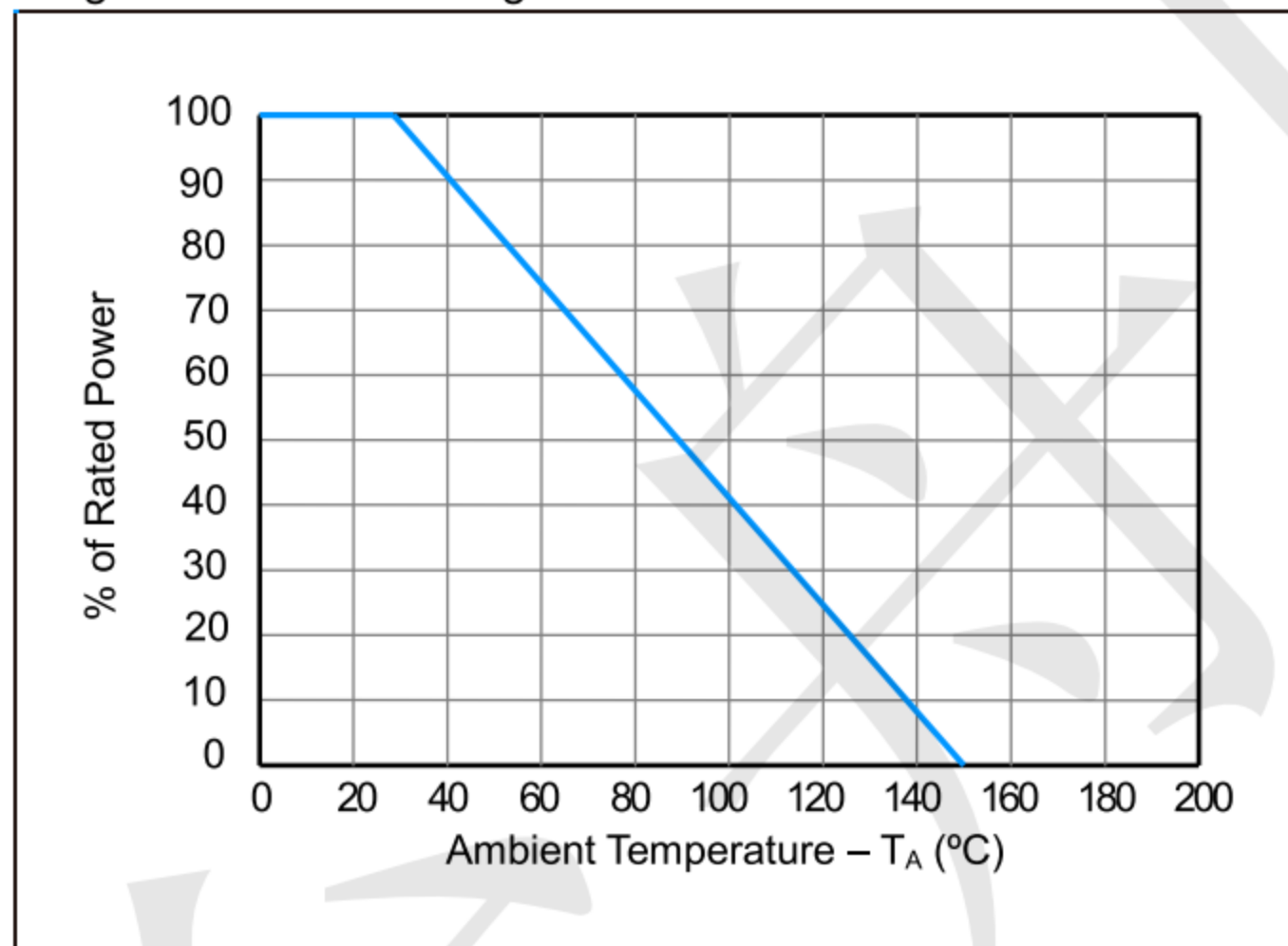
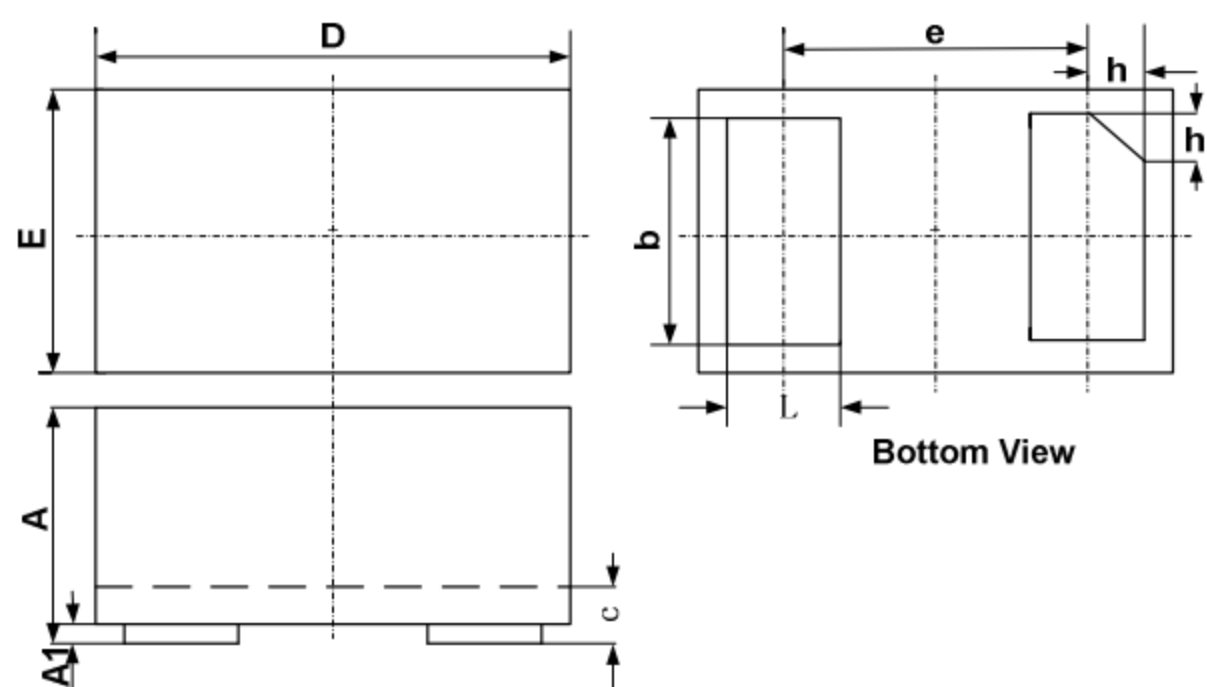

Fig3. Power Derating Curve





**DFN1610-2 Package Outline Drawing**



SYM	DIMENSIONS					
	MILLIMETERS			INCHES		
	MIN	NOM	MAX	MIN	NOM	MAX
A	0.45	0.50	0.55	0.018	0.020	0.022
A1	0.00	0.02	0.05	0.000	0.001	0.002
b	0.75	0.80	0.85	0.030	0.032	0.034
c	0.10	0.15	0.20	0.004	0.006	0.008
D	1.55	1.60	1.65	0.062	0.064	0.066
e	1.10 BSC			0.044 BSC		
E	0.95	1.00	1.05	0.038	0.040	0.042
L	0.35	0.40	0.45	0.014	0.016	0.018
h	0.15	0.20	0.25	0.006	0.008	0.010

**Suggested Land Pattern**

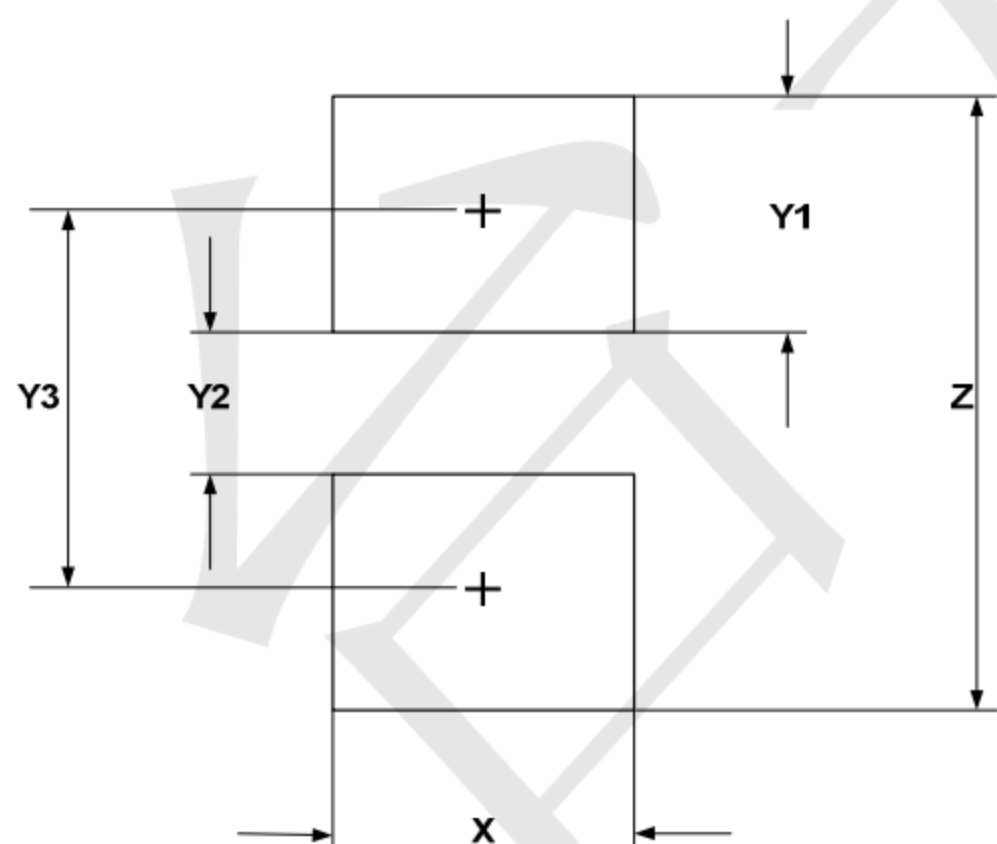

SYM	DIMENSIONS	
	MILLIMETERS	INCHES
X	1.00	0.040
Y1	0.62	0.025
Y2	0.60	0.024
Y3	1.22	0.049
Z	1.85	0.074