

## DS25BR100 / DS25BR101 3.125 Gbps LVDS Buffer with Transmit Pre-Emphasis and Receive Equalization

Check for Samples: [DS25BR100](#)

### FEATURES

- DC - 3.125 Gbps Low Jitter, High Noise Immunity, Low Power Operation
- Receive Equalization Reduces ISI Jitter Due to Media Loss
- Transmit Pre-Emphasis Drives Lossy Backplanes and Cables
- On-Chip 100Ω Input and Output Termination:
  - Minimizes Insertion and Return Losses
  - Reduces Component Count
  - Minimizes Board Space
- DS25BR101 Eliminates On-Chip Input Termination for Added Design Flexibility
- 7 kV ESD on LVDS I/O Pins Protects Adjoining Components
- Small 3 mm x 3 mm WSON-8 Space Saving Package

### APPLICATIONS

- Clock and Data Buffering
- Metallic Cable Driving and Equalization
- FR-4 Equalization

### DESCRIPTION

The DS25BR100 and DS25BR101 are single channel 3.125 Gbps LVDS buffers optimized for high-speed signal transmission over lossy FR-4 printed circuit board backplanes and balanced metallic cables. Fully differential signal paths ensure exceptional signal integrity and noise immunity.

The DS25BR100 and DS25BR101 feature transmit pre-emphasis (PE) and receive equalization (EQ), making them ideal for use as a repeater device. Other LVDS devices with similar IO characteristics include the following products. The DS25BR120 features four levels of pre-emphasis for use as an optimized driver device, while the DS25BR110 features four levels of equalization for use as an optimized receiver device. The DS25BR150 is a buffer/repeater with the lowest power consumption and does not feature transmit pre-emphasis nor receive equalization.

Wide input common mode range allows the receiver to accept signals with LVDS, CML and LVPECL levels; the output levels are LVDS. A very small package footprint requires minimal space on the board while the flow-through pinout allows easy board layout. On the DS25BR100 the differential input and output is internally terminated with a 100Ω resistor to lower return losses, reduce component count and further minimize board space. For added design flexibility the 100Ω input terminations on the DS25BR101 have been eliminated. This elimination enables a designer to adjust the termination for custom interconnect topologies and layout.

### Typical Application

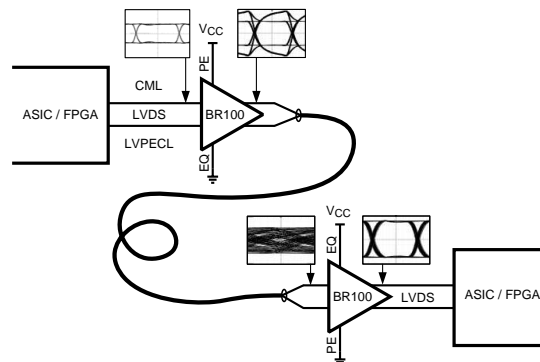

Please be aware that an important notice concerning availability, standard warranty, and use in critical applications of Texas Instruments semiconductor products and disclaimers thereto appears at the end of this data sheet.

All trademarks are the property of their respective owners.

### Device Information

Device	Function	Termination Option	Available Signal Conditioning
DS25BR100	Buffer / Repeater	Internal 100Ω for LVDS inputs	2 Levels: PE and EQ
DS25BR101	Buffer / Repeater	External termination required	2 Levels: PE and EQ
DS25BR110	Receiver	Internal 100Ω for LVDS inputs	4 Levels: EQ
DS25BR120	Driver	Internal 100Ω for LVDS inputs	4 Levels: PE
DS25BR150	Buffer / Repeater	Internal 100Ω for LVDS inputs	None

### Block Diagram

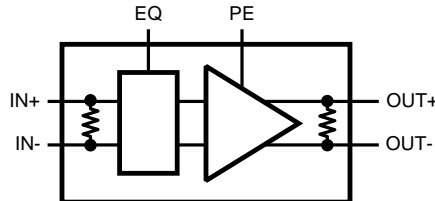

DS25BR101 eliminates 100Ω input termination.

### Pin Diagram

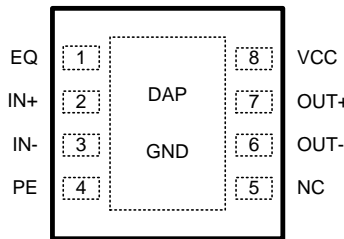

### PIN DESCRIPTIONS

Pin Name	Pin Name	Pin Type	Pin Description
EQ	1	Input	Equalizer select pin.
IN+	2	Input	Non-inverting LVDS input pin.
IN-	3	Input	Inverting LVDS input pin.
PE	4	Input	Pre-emphasis select pin.
NC	5	NA	"NO CONNECT" pin.
OUT-	6	Output	Inverting LVDS output pin.
OUT+	7	Output	Non-inverting LVDS Output pin.
VCC	8	Power	Power supply pin.
GND	DAP	Power	Ground pad (DAP - die attach pad).

### Control Pins (PE and EQ) Truth Table

EQ	PE	Equalization Level	Pre-emphasis Level
0	0	Low (Approx. 4 dB at 1.56 GHz)	Off
0	1	Low (Approx. 4 dB at 1.56 GHz)	Medium (Approx. 6 dB at 1.56 GHz)
1	0	Medium (Approx. 8 dB at 1.56 GHz)	Off
1	1	Medium (Approx. 8 dB at 1.56 GHz)	Medium (Approx. 6 dB at 1.56 GHz)



These devices have limited built-in ESD protection. The leads should be shorted together or the device placed in conductive foam during storage or handling to prevent electrostatic damage to the MOS gates.

### Absolute Maximum Ratings<sup>(1)(2)</sup>

Supply Voltage ( $V_{CC}$ )		-0.3V to +4V
LVCMOS Input Voltage (EQ, PE)		-0.3V to ( $V_{CC} + 0.3V$ )
LVDS Input Voltage (IN+, IN-)		-0.3V to +4V
Differential Input Voltage  VID  (DS25BR100)		1V
LVDS Differential Input Voltage (DS25BR101)		$V_{CC} + 0.6V$
LVDS Output Voltage (OUT+, OUT-)		-0.3V to ( $V_{CC} + 0.3V$ )
LVDS Differential Output Voltage ((OUT+) - (OUT-))		0V to 1V
LVDS Output Short Circuit Current Duration		5 ms
Junction Temperature		+150°C
Storage Temperature Range		-65°C to +150°C
Lead Temperature Range	Soldering (4 sec.)	+260°C
Maximum Package Power Dissipation at 25°C	NGQ0008A Package	2.08W
	Derate NGQ0008A Package	16.7 mW/°C above +25°C
Package Thermal Resistance	$\theta_{JA}$	+60.0°C/W
	$\theta_{JC}$	+12.3°C/W
ESD Susceptibility	HBM <sup>(3)</sup>	≥7 kV
	MM <sup>(4)</sup>	≥250V
	CDM <sup>(5)</sup>	≥1250V

- (1) "Absolute Maximum Ratings" indicate limits beyond which damage to the device may occur, including inoperability and degradation of device reliability and/or performance. Functional operation of the device and/or non-degradation at the Absolute Maximum Ratings or other conditions beyond those indicated in the Recommended Operating Conditions is not implied. The Recommended Operating Conditions indicate conditions at which the device is functional and the device should not be operated beyond such conditions.
- (2) If Military/Aerospace specified devices are required, please contact the TI Sales Office/Distributors for availability and specifications.
- (3) Human Body Model, applicable std. JESD22-A114C
- (4) Machine Model, applicable std. JESD22-A115-A
- (5) Field Induced Charge Device Model, applicable std. JESD22-C101-C

### Recommended Operating Conditions

	Min	Typ	Max	Units
Supply Voltage ( $V_{CC}$ )	3.0	3.3	3.6	V
Receiver Differential Input Voltage ( $V_{ID}$ ) (DS25BR100 only)			1.0	V
Operating Free Air Temperature ( $T_A$ )	-40	+25	+85	°C

## DC Electrical Characteristics

Over recommended operating supply and temperature ranges unless otherwise specified<sup>(1)(2)(3)</sup>

Parameter		Test Conditions	Min	Typ	Max	Units
<b>LVCMOS INPUT DC SPECIFICATIONS (EQ, PE)</b>						
V <sub>IH</sub>	High Level Input Voltage		2.0		V <sub>CC</sub>	V
V <sub>IL</sub>	Low Level Input Voltage		GND		0.8	V
I <sub>IH</sub>	High Level Input Current	V <sub>IN</sub> = 3.6V V <sub>CC</sub> = 3.6V		0	±10	µA
I <sub>IL</sub>	Low Level Input Current	V <sub>IN</sub> = GND V <sub>CC</sub> = 3.6V		0	±10	µA
V <sub>CL</sub>	Input Clamp Voltage	I <sub>CL</sub> = -18 mA, V <sub>CC</sub> = 0V		-0.9	-1.5	V
<b>LVDS OUTPUT DC SPECIFICATIONS (OUT+, OUT-)</b>						
V <sub>OD</sub>	Differential Output Voltage		250	350	450	mV
ΔV <sub>OD</sub>	Change in Magnitude of V <sub>OD</sub> for Complimentary Output States	R <sub>L</sub> = 100Ω	-35		35	mV
V <sub>OS</sub>	Offset Voltage		1.05	1.2	1.375	V
ΔV <sub>OS</sub>	Change in Magnitude of V <sub>OS</sub> for Complimentary Output States	R <sub>L</sub> = 100Ω	-35		35	mV
I <sub>OS</sub>	Output Short Circuit Current <sup>(4)</sup>	OUT to GND, PE = 0		-35	-55	mA
		OUT to V <sub>CC</sub> , PE = 0		7	55	mA
C <sub>OUT</sub>	Output Capacitance	Any LVDS Output Pin to GND		1.2		pF
R <sub>OUT</sub>	Output Termination Resistor	Between OUT+ and OUT-		100		Ω
<b>LVDS INPUT DC SPECIFICATIONS (IN+, IN-)</b>						
V <sub>ID</sub>	Input Differential Voltage <sup>(5)</sup>		0		1	V
V <sub>TH</sub>	Differential Input High Threshold	V <sub>CM</sub> = +0.05V or V <sub>CC</sub> -0.05V		0	+100	mV
V <sub>TL</sub>	Differential Input Low Threshold		-100	0		mV
V <sub>CMR</sub>	Common Mode Voltage Range	V <sub>ID</sub> = 100 mV	0.05		V <sub>CC</sub> - 0.05	V
I <sub>IN</sub>	Input Current	V <sub>IN</sub> = GND or 3.6V V <sub>CC</sub> = 3.6V or 0.0V		±1	±10	µA
C <sub>IN</sub>	Input Capacitance	Any LVDS Input Pin to GND		1.7		pF
R <sub>IN</sub>	Input Termination Resistor <sup>(6)</sup>	Between IN+ and IN-		100		Ω
<b>SUPPLY CURRENT</b>						
I <sub>CC</sub>	Supply Current	EQ = 0, PE = 0		35	43	mA

- (1) The Electrical Characteristics tables list ensured specifications under the listed Recommended Operating Conditions except as otherwise modified or specified by the Electrical Characteristics Conditions and/or Notes. Typical specifications are estimations only and are not ensured.
- (2) Current into device pins is defined as positive. Current out of device pins is defined as negative. All voltages are referenced to ground except V<sub>OD</sub> and ΔV<sub>OD</sub>.
- (3) Typical values represent most likely parametric norms for V<sub>CC</sub> = +3.3V and T<sub>A</sub> = +25°C, and at the Recommended Operation Conditions at the time of product characterization and are not ensured.
- (4) Output short circuit current (I<sub>OS</sub>) is specified as magnitude only, minus sign indicates direction only.
- (5) Input Differential Voltage (V<sub>ID</sub>) The DS25BR100 limits input amplitude to 1 volt. The DS25BR101 supports any V<sub>ID</sub> within the supply voltage to GND range.
- (6) Input Termination Resistor (R<sub>IN</sub>) The DS25BR100 provides an integrated 100 ohm input termination for the high speed LVDS pair. The DS25BR101 eliminates this internal termination.

## AC Electrical Characteristics<sup>(1)</sup>

Over recommended operating supply and temperature ranges unless otherwise specified<sup>(2)(3)</sup>

Parameter		Test Conditions	Min	Typ	Max	Units	
<b>LVDS OUTPUT AC SPECIFICATIONS (OUT+, OUT-)</b>							
$t_{PHLD}$	Differential Propagation Delay High to Low	$R_L = 100\Omega$		350	465	ps	
$t_{PLHD}$	Differential Propagation Delay Low to High			350	465	ps	
$t_{SKD1}$	Pulse Skew $ t_{PLHD} - t_{PHLD} $ <sup>(4)</sup>			45	100	ps	
$t_{SKD2}$	Part to Part Skew <sup>(5)</sup>			45	150	ps	
$t_{LHT}$	Rise Time	$R_L = 100\Omega$		80	150	ps	
$t_{HLT}$	Fall Time			80	150	ps	
<b>JITTER PERFORMANCE WITH PE = OFF AND EQ = LOW<sup>(6)(7)</sup></b>							
$t_{RJ1A}$	Random Jitter (RMS Value) Input Test Channel D <sup>(8)</sup>	$V_{ID} = 350\text{ mV}$ $V_{CM} = 1.2\text{V}$ Clock (RZ) PE = 0, EQ = 0	2.5 Gbps		0.5	1	ps
$t_{RJ2A}$			3.125 Gbps		0.5	1	ps
$t_{DJ1A}$	Deterministic Jitter (Peak to Peak) Input Test Channel D <sup>(9)</sup>	$V_{ID} = 350\text{ mV}$ $V_{CM} = 1.2\text{V}$ K28.5 (NRZ) PE = 0, EQ = 0	2.5 Gbps		1	16	ps
$t_{DJ2A}$			3.125 Gbps		11	31	ps
$t_{TJ1A}$	Total Jitter (Peak to Peak) Input Test Channel D <sup>(10)</sup>	$V_{ID} = 350\text{ mV}$ $V_{CM} = 1.2\text{V}$ PRBS-23 (NRZ) PE = 0, EQ = 0	2.5 Gbps		0.03	0.09	UI <sub>P-P</sub>
$t_{TJ2A}$			3.125 Gbps		0.06	0.14	UI <sub>P-P</sub>
<b>JITTER PERFORMANCE WITH PE = OFF AND EQ = MEDIUM<sup>(6)(7)</sup></b>							
$t_{RJ1B}$	Random Jitter (RMS Value) Input Test Channel E <sup>(8)</sup>	$V_{ID} = 350\text{ mV}$ $V_{CM} = 1.2\text{V}$ Clock (RZ) PE = 0, EQ = 1	2.5 Gbps		0.5	1	ps
$t_{RJ2B}$			3.125 Gbps		0.5	1	ps
$t_{DJ1B}$	Deterministic Jitter (Peak to Peak) Input Test Channel E <sup>(9)</sup>	$V_{ID} = 350\text{ mV}$ $V_{CM} = 1.2\text{V}$ K28.5 (NRZ) PE = 0, EQ = 1	2.5 Gbps		10	29	ps
$t_{DJ2B}$			3.125 Gbps		27	43	ps
$t_{TJ1B}$	Total Jitter (Peak to Peak) Input Test Channel E <sup>(10)</sup>	$V_{ID} = 350\text{ mV}$ $V_{CM} = 1.2\text{V}$ PRBS-23 (NRZ) PE = 0, EQ = 1	2.5 Gbps		0.07	0.12	UI <sub>P-P</sub>
$t_{TJ2B}$			3.125 Gbps		0.12	0.17	UI <sub>P-P</sub>

- (1) Specification is ensured by characterization and is not tested in production.
- (2) The Electrical Characteristics tables list ensured specifications under the listed Recommended Operating Conditions except as otherwise modified or specified by the Electrical Characteristics Conditions and/or Notes. Typical specifications are estimations only and are not ensured.
- (3) Typical values represent most likely parametric norms for  $V_{CC} = +3.3\text{V}$  and  $T_A = +25^\circ\text{C}$ , and at the Recommended Operation Conditions at the time of product characterization and are not ensured.
- (4)  $t_{SKD1}$ ,  $|t_{PLHD} - t_{PHLD}|$ , is the magnitude difference in differential propagation delay time between the positive going edge and the negative going edge of the same channel.
- (5)  $t_{SKD2}$ , Part to Part Skew, is defined as the difference between the minimum and maximum differential propagation delays. This specification applies to devices at the same  $V_{CC}$  and within  $5^\circ\text{C}$  of each other within the operating temperature range.
- (6) Current into device pins is defined as positive. Current out of device pins is defined as negative. All voltages are referenced to ground except  $V_{OD}$  and  $\Delta V_{OD}$ .
- (7) Typical values represent most likely parametric norms for  $V_{CC} = +3.3\text{V}$  and  $T_A = +25^\circ\text{C}$ , and at the Recommended Operation Conditions at the time of product characterization and are not ensured.
- (8) Measured on a clock edge with a histogram and an accumulation of 1500 histogram hits. Input stimulus jitter is subtracted geometrically.
- (9) Tested with a combination of the 110000101 (K28.5+ character) and 0011111010 (K28.5- character) patterns. Input stimulus jitter is subtracted algebraically.
- (10) Measured on an eye diagram with a histogram and an accumulation of 3500 histogram hits. Input stimulus jitter is subtracted.

## AC Electrical Characteristics<sup>(1)</sup> (continued)

Over recommended operating supply and temperature ranges unless otherwise specified<sup>(2)(3)</sup>

Parameter		Test Conditions	Min	Typ	Max	Units
<b>JITTER PERFORMANCE WITH PE = MEDIUM AND EQ = LOW<sup>(11)(12)</sup></b>						
$t_{RJ1C}$	Random Jitter (RMS Value) Input Test Channel D Output Test Channel B <sup>(13)</sup>	$V_{ID} = 350\text{ mV}$ $V_{CM} = 1.2\text{V}$ Clock (RZ) $PE = 1, EQ = 0$	2.5 Gbps		0.5	1 ps
$t_{RJ2C}$			3.125 Gbps		0.5	1 ps
$t_{DJ1C}$	Deterministic Jitter (Peak to Peak) Input Test Channel D Output Test Channel B <sup>(14)</sup>	$V_{ID} = 350\text{ mV}$ $V_{CM} = 1.2\text{V}$ K28.5 (NRZ) $PE = 1, EQ = 0$	2.5 Gbps		29	57 ps
$t_{DJ2C}$			3.125 Gbps		29	51 ps
$t_{TJ1C}$	Total Jitter (Peak to Peak) Input Test Channel D Output Test Channel B <sup>(15)</sup>	$V_{ID} = 350\text{ mV}$ $V_{CM} = 1.2\text{V}$ PRBS-23 (NRZ) $PE = 1, EQ = 0$	2.5 Gbps		0.10	0.19 $U_{I_{P-P}}$
$t_{TJ2C}$			3.125 Gbps		0.13	0.22 $U_{I_{P-P}}$
<b>JITTER PERFORMANCE WITH PE = MEDIUM AND EQ = MEDIUM<sup>(11)(12)</sup></b>						
$t_{RJ1D}$	Random Jitter (RMS Value) Input Test Channel E Output Test Channel B <sup>(13)</sup>	$V_{ID} = 350\text{ mV}$ $V_{CM} = 1.2\text{V}$ Clock (RZ) $PE = 1, EQ = 1$	2.5 Gbps		0.5	1.1 ps
$t_{RJ2D}$			3.125 Gbps		0.5	1 ps
$t_{DJ1D}$	Deterministic Jitter (Peak to Peak) Input Test Channel E Output Test Channel B <sup>(14)</sup>	$V_{ID} = 350\text{ mV}$ $V_{CM} = 1.2\text{V}$ K28.5 (NRZ) $PE = 1, EQ = 1$	2.5 Gbps		41	77 ps
$t_{DJ2D}$			3.125 Gbps		46	98 ps
$t_{TJ1D}$	Total Jitter (Peak to Peak) Input Test Channel E Output Test Channel B <sup>(15)</sup>	$V_{ID} = 350\text{ mV}$ $V_{CM} = 1.2\text{V}$ PRBS-23 (NRZ) $PE = 1, EQ = 1$	2.5 Gbps		0.13	0.20 $U_{I_{P-P}}$
$t_{TJ2D}$			3.125 Gbps		0.19	0.30 $U_{I_{P-P}}$

(11) Typical values represent most likely parametric norms for  $V_{CC} = +3.3\text{V}$  and  $T_A = +25^\circ\text{C}$ , and at the Recommended Operation Conditions at the time of product characterization and are not ensured.

(12) Input Differential Voltage ( $V_{ID}$ ) The DS25BR100 limits input amplitude to 1 volt. The DS25BR101 supports any  $V_{ID}$  within the supply voltage to GND range.

(13) Measured on a clock edge with a histogram and an accumulation of 1500 histogram hits. Input stimulus jitter is subtracted geometrically.

(14) Tested with a combination of the 1100000101 (K28.5+ character) and 0011111010 (K28.5- character) patterns. Input stimulus jitter is subtracted algebraically.

(15) Measured on an eye diagram with a histogram and an accumulation of 3500 histogram hits. Input stimulus jitter is subtracted.

### Typical Performance Characteristics

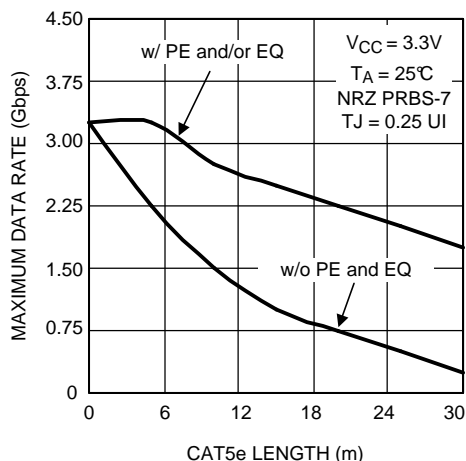

Figure 1. Maximum Data Rate as a Function of CAT5e (Belden 1700A) Length

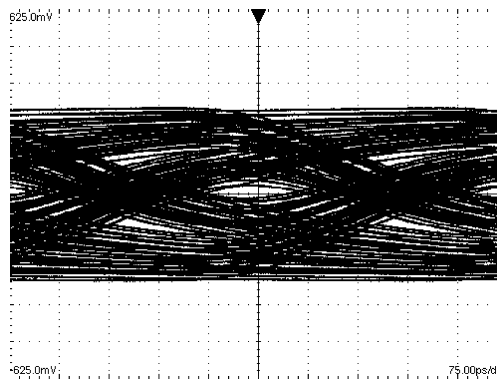

Figure 2. A 2.5 Gbps NRZ PRBS-7 After 60" Differential FR-4 Stripline V:125 mV / DIV, H:75 ps / DIV

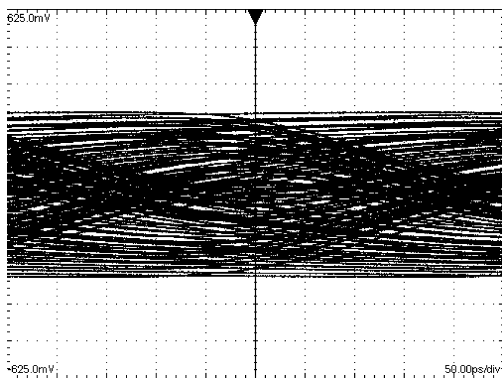

Figure 3. A 3.125 Gbps NRZ PRBS-7 After 60" Differential FR-4 Stripline V:125 mV / DIV, H:50 ps / DIV

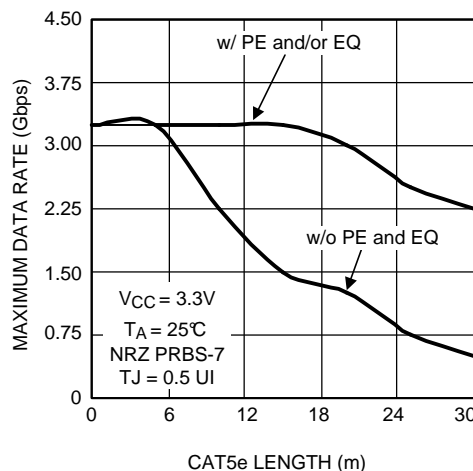

Figure 4. Maximum Data Rate as a Function of CAT5e (Belden 1700A) Length

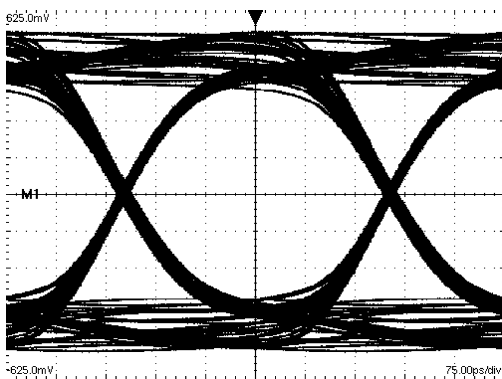

Figure 5. An Equalized (with PE and EQ) 2.5 Gbps NRZ PRBS-7 After The 40" Input and 20" Output Differential Stripline (Figure 16) V:125 mV / DIV, H:75 ps / DIV

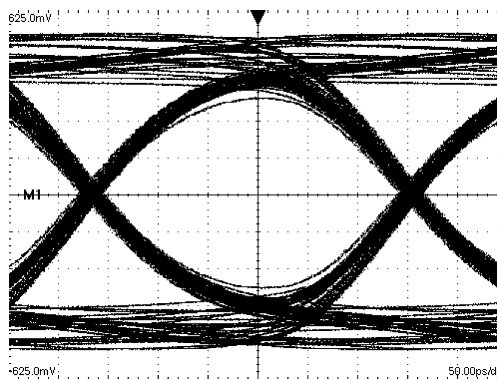

Figure 6. An Equalized (with PE and EQ) 3.125 Gbps NRZ PRBS-7 After The 40" Input and 20" Output Differential Stripline (Figure 16) V:125 mV / DIV, H:50 ps / DIV

Typical Performance Characteristics (continued)

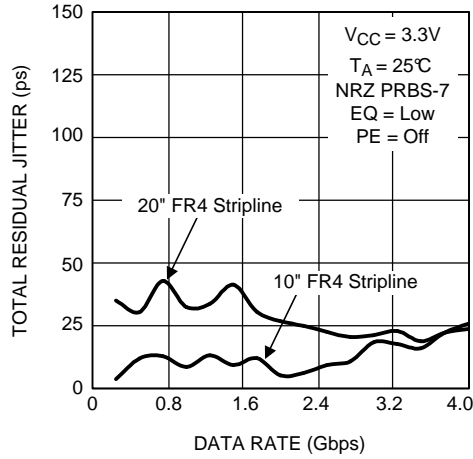

Figure 7. Total Jitter as a Function of Data Rate

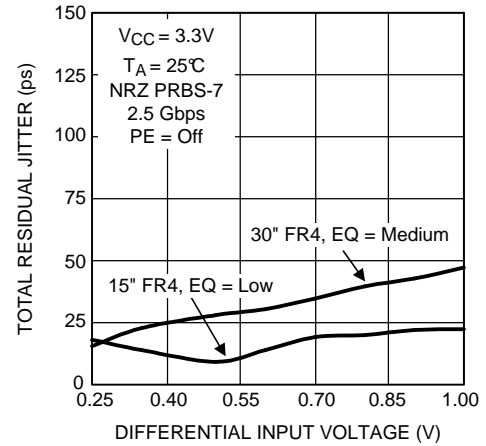

Figure 8. Total Jitter as a Function of Input Amplitude

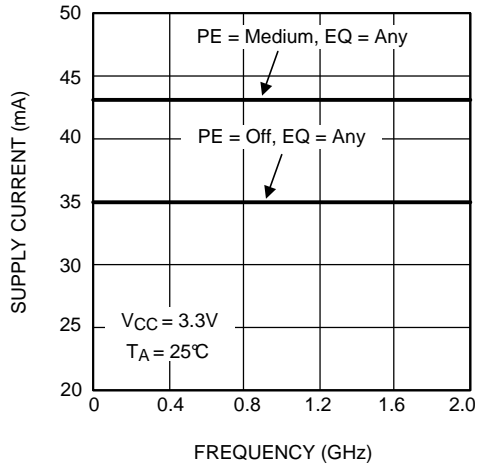

Figure 9. Power Supply Current as a Function of Frequency

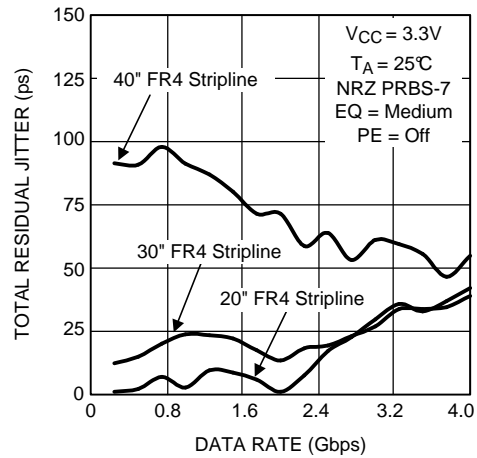

Figure 10. Total Jitter as a Function of Data Rate

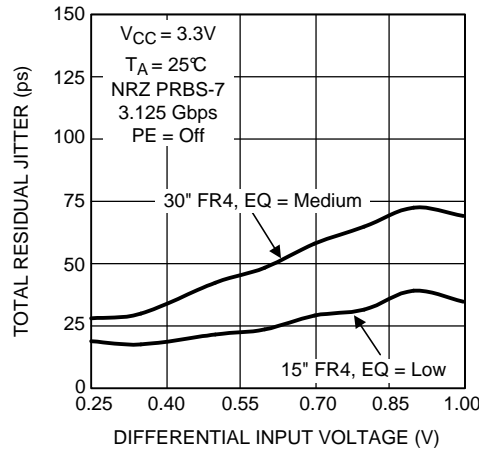

Figure 11. Total Jitter as a Function of Input Amplitude



## APPLICATION INFORMATION

### DC Test Circuits

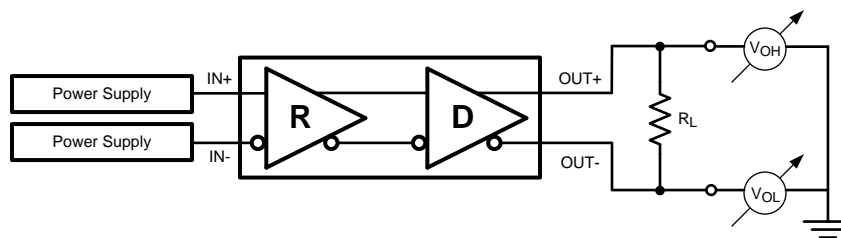

Figure 12. Differential Driver DC Test Circuit

### AC Test Circuits and Timing Diagrams

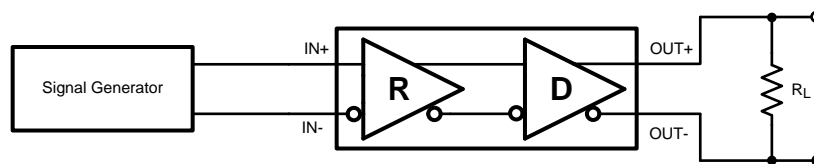

Figure 13. Differential Driver AC Test Circuit

#### NOTE

DS25BR101 requires external 100Ω input termination.

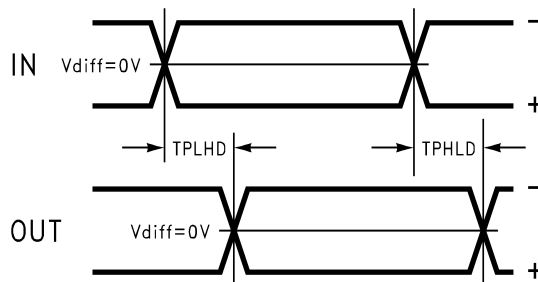

Figure 14. Propagation Delay Timing Diagram

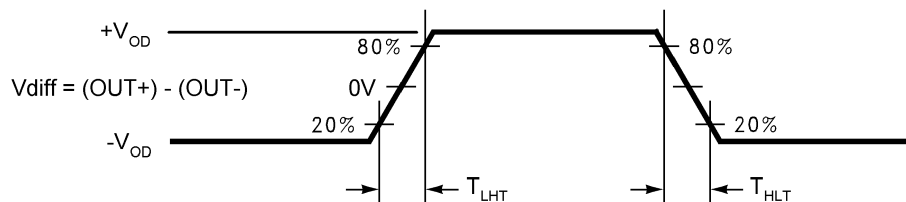

Figure 15. LVDS Output Transition Times

### Pre-Emphasis and Equalization Test Circuits

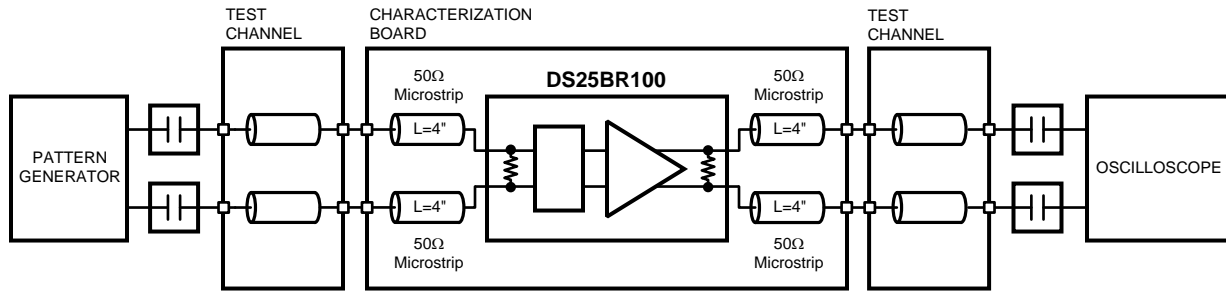

Figure 16. Pre-emphasis and Equalization Performance Test Circuit

**NOTE**

DS25BR101 requires external 100Ω input termination.

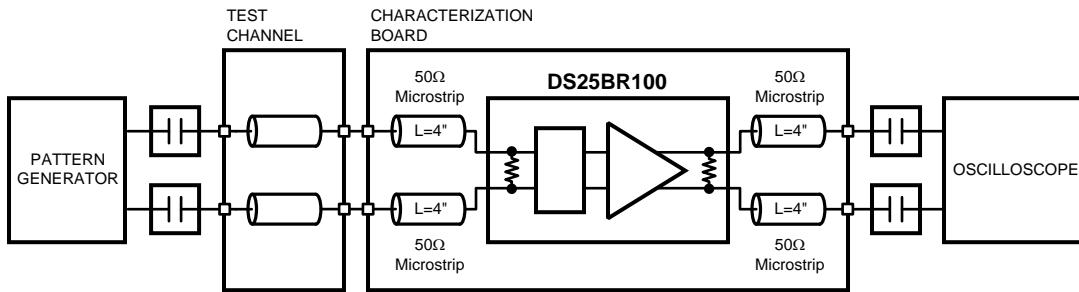

Figure 17. Equalization Performance Test Circuit

**NOTE**

DS25BR101 requires external 100Ω input termination.

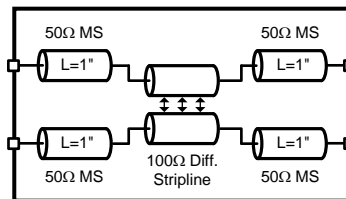

Figure 18. Test Channel Description

### Test Channel Loss Characteristics

The test channel was fabricated with Polyclad PCL-FR-370-Laminate/PCL-FRP-370 Prepreg materials (Dielectric constant of 3.7 and Loss Tangent of 0.02). The edge coupled differential striplines have the following geometries: Trace Width (W) = 5 mils, Gap (S) = 5 mils, Height (B) = 16 mils.

Test Channel	Length (inches)	Insertion Loss (dB)					
		500 MHz	750 MHz	1000 MHz	1250 MHz	1500 MHz	1560 MHz
A	10	-1.2	-1.7	-2.0	-2.4	-2.7	-2.8
B	20	-2.6	-3.5	-4.1	-4.8	-5.5	-5.6
C	30	-4.3	-5.7	-7.0	-8.2	-9.4	-9.7
D	15	-1.6	-2.2	-2.7	-3.2	-3.7	-3.8
E	30	-3.4	-4.5	-5.6	-6.6	-7.7	-7.9
F	60	-7.8	-10.3	-12.4	-14.5	-16.6	-17.0

### Device Operation

#### INPUT INTERFACING

The DS25BR100/101 accepts differential signals and allows simple AC or DC coupling. With a wide common mode range, the DS25BR100/101 can be DC-coupled with all common differential drivers (i.e. LVPECL, LVDS, CML). The following three figures illustrate typical DC-coupled interface to common differential drivers.

The DS25BR100 inputs are internally terminated with a 100Ω resistor for optimal device performance, reduced component count, and minimum board space. External input terminations on the DS25BR101 need to be placed as close as possible to the device inputs to achieve equivalent AC performance. It is recommended to use SMT resistors sized 0402 or smaller and to keep the mounting distance to the DS25BR101 pins under 200 mils.

When using the DS25BR101 in a limited multi-drop topology, any transmission line stubs should be kept very short to minimize any negative effects on signal quality. A single termination resistor or resistor network that matches the differential line impedance should be used. If DS25BR101 input pairs from two separate devices are to be connected to a single differential output, it is recommended to mount the DS25BR101 devices directly opposite of each other. One on top of the PCB and the other directly under the first on the bottom of the PCB keeps the distance between inputs equal to the PCB thickness.

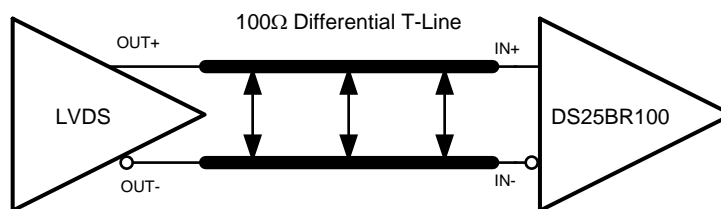

Figure 19. Typical LVDS Driver DC-Coupled Interface to DS25BR100 Input

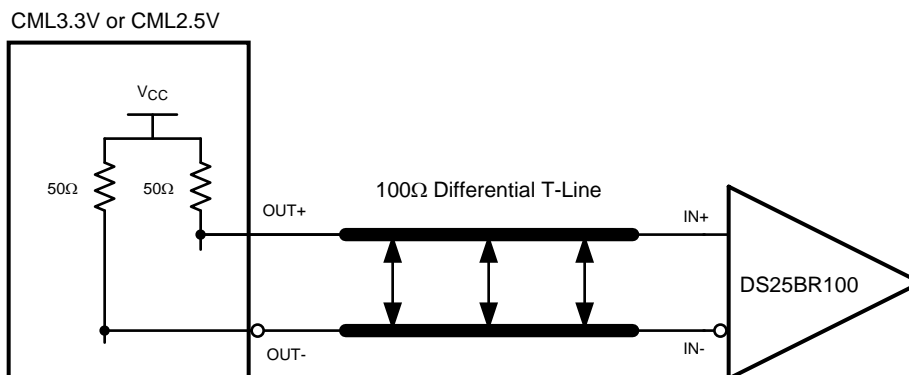
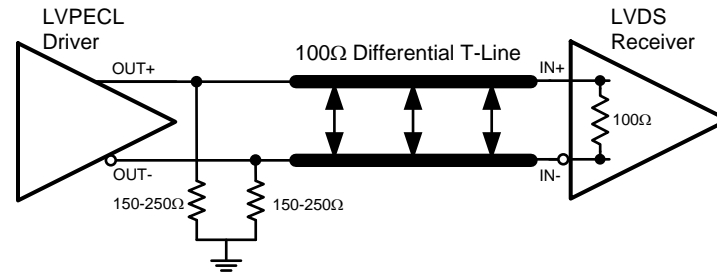

Figure 20. Typical CML Driver DC-Coupled Interface to DS25BR100 Input



**Figure 21. Typical LVPECL Driver DC-Coupled Interface to DS25BR100 Input**

**NOTE**

DS25BR101 requires external 100Ω input termination.

**OUTPUT INTERFACING**

The DS25BR100/101 outputs signals are compliant to the LVDS standard. It can be DC-coupled to most common differential receivers. The following figure illustrates the typical DC-coupled interface to common differential receivers and assumes that the receivers have high impedance inputs. While most differential receivers have a common mode input range that can accommodate LVDS compliant signals, it is recommended to check the respective receiver's datasheet prior to implementing the suggested interface implementation.

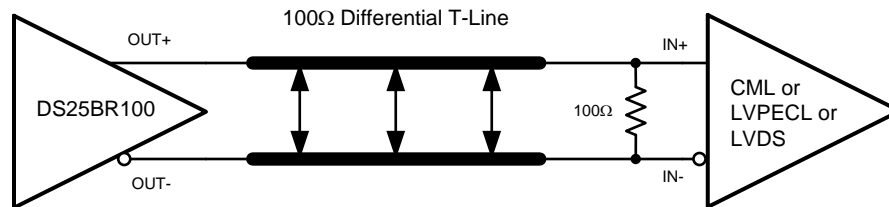

**Figure 22. Typical Output DC-Coupled Interface to an LVDS, CML or LVPECL Receiver**

---

**REVISION HISTORY**

<b>Changes from Revision E (April 2013) to Revision F</b>	<b>Page</b>
• Changed layout of National Data Sheet to TI format .....	<a href="#">12</a>

---

**PACKAGING INFORMATION**

Orderable Device	Status (1)	Package Type	Package Drawing	Pins	Package Qty	Eco Plan (2)	Lead/Ball Finish (6)	MSL Peak Temp (3)	Op Temp (°C)	Device Marking (4/5)	Samples
DS25BR100TSD/NOPB	ACTIVE	WSO	NGQ	8	1000	Green (RoHS & no Sb/Br)	CU SN	Level-3-260C-168 HR	-40 to 85	2R100	<a href="#">Samples</a>
DS25BR101TSD/NOPB	ACTIVE	WSO	NGQ	8	1000	Green (RoHS & no Sb/Br)	CU SN	Level-3-260C-168 HR	-40 to 85	2R101	<a href="#">Samples</a>
DS25BR101TSDE/NOPB	ACTIVE	WSO	NGQ	8	250	Green (RoHS & no Sb/Br)	CU SN	Level-3-260C-168 HR	-40 to 85	2R101	<a href="#">Samples</a>
DS25BR101TSDX/NOPB	ACTIVE	WSO	NGQ	8	4500	Green (RoHS & no Sb/Br)	CU SN	Level-3-260C-168 HR	-40 to 85	2R101	<a href="#">Samples</a>

(1) The marketing status values are defined as follows:

**ACTIVE:** Product device recommended for new designs.

**LIFEBUY:** TI has announced that the device will be discontinued, and a lifetime-buy period is in effect.

**NRND:** Not recommended for new designs. Device is in production to support existing customers, but TI does not recommend using this part in a new design.

**PREVIEW:** Device has been announced but is not in production. Samples may or may not be available.

**OBSELETE:** TI has discontinued the production of the device.

(2) Eco Plan - The planned eco-friendly classification: Pb-Free (RoHS), Pb-Free (RoHS Exempt), or Green (RoHS & no Sb/Br) - please check <http://www.ti.com/productcontent> for the latest availability information and additional product content details.

**TBD:** The Pb-Free/Green conversion plan has not been defined.

**Pb-Free (RoHS):** TI's terms "Lead-Free" or "Pb-Free" mean semiconductor products that are compatible with the current RoHS requirements for all 6 substances, including the requirement that lead not exceed 0.1% by weight in homogeneous materials. Where designed to be soldered at high temperatures, TI Pb-Free products are suitable for use in specified lead-free processes.

**Pb-Free (RoHS Exempt):** This component has a RoHS exemption for either 1) lead-based flip-chip solder bumps used between the die and package, or 2) lead-based die adhesive used between the die and leadframe. The component is otherwise considered Pb-Free (RoHS compatible) as defined above.

**Green (RoHS & no Sb/Br):** TI defines "Green" to mean Pb-Free (RoHS compatible), and free of Bromine (Br) and Antimony (Sb) based flame retardants (Br or Sb do not exceed 0.1% by weight in homogeneous material)

(3) MSL, Peak Temp. - The Moisture Sensitivity Level rating according to the JEDEC industry standard classifications, and peak solder temperature.

(4) There may be additional marking, which relates to the logo, the lot trace code information, or the environmental category on the device.

(5) Multiple Device Markings will be inside parentheses. Only one Device Marking contained in parentheses and separated by a "~" will appear on a device. If a line is indented then it is a continuation of the previous line and the two combined represent the entire Device Marking for that device.

(6) Lead/Ball Finish - Orderable Devices may have multiple material finish options. Finish options are separated by a vertical ruled line. Lead/Ball Finish values may wrap to two lines if the finish value exceeds the maximum column width.

**Important Information and Disclaimer:** The information provided on this page represents TI's knowledge and belief as of the date that it is provided. TI bases its knowledge and belief on information provided by third parties, and makes no representation or warranty as to the accuracy of such information. Efforts are underway to better integrate information from third parties. TI has taken and continues to take reasonable steps to provide representative and accurate information but may not have conducted destructive testing or chemical analysis on incoming materials and chemicals. TI and TI suppliers consider certain information to be proprietary, and thus CAS numbers and other limited information may not be available for release.

In no event shall TI's liability arising out of such information exceed the total purchase price of the TI part(s) at issue in this document sold by TI to Customer on an annual basis.

## TAPE AND REEL INFORMATION



### QUADRANT ASSIGNMENTS FOR PIN 1 ORIENTATION IN TAPE



\*All dimensions are nominal

Device	Package Type	Package Drawing	Pins	SPQ	Reel Diameter (mm)	Reel Width W1 (mm)	A0 (mm)	B0 (mm)	K0 (mm)	P1 (mm)	W (mm)	Pin1 Quadrant
DS25BR100TSD/NOPB	WSON	NGQ	8	1000	178.0	12.4	3.3	3.3	1.0	8.0	12.0	Q1
DS25BR101TSD/NOPB	WSON	NGQ	8	1000	178.0	12.4	3.3	3.3	1.0	8.0	12.0	Q1
DS25BR101TSDE/NOPB	WSON	NGQ	8	250	178.0	12.4	3.3	3.3	1.0	8.0	12.0	Q1
DS25BR101TSDX/NOPB	WSON	NGQ	8	4500	330.0	12.4	3.3	3.3	1.0	8.0	12.0	Q1



## TAPE AND REEL BOX DIMENSIONS



\*All dimensions are nominal

Device	Package Type	Package Drawing	Pins	SPQ	Length (mm)	Width (mm)	Height (mm)
DS25BR100TSD/NOPB	WSON	NGQ	8	1000	213.0	191.0	55.0
DS25BR101TSD/NOPB	WSON	NGQ	8	1000	213.0	191.0	55.0
DS25BR101TSDE/NOPB	WSON	NGQ	8	250	213.0	191.0	55.0
DS25BR101TSDX/NOPB	WSON	NGQ	8	4500	367.0	367.0	35.0

NGQ0008A

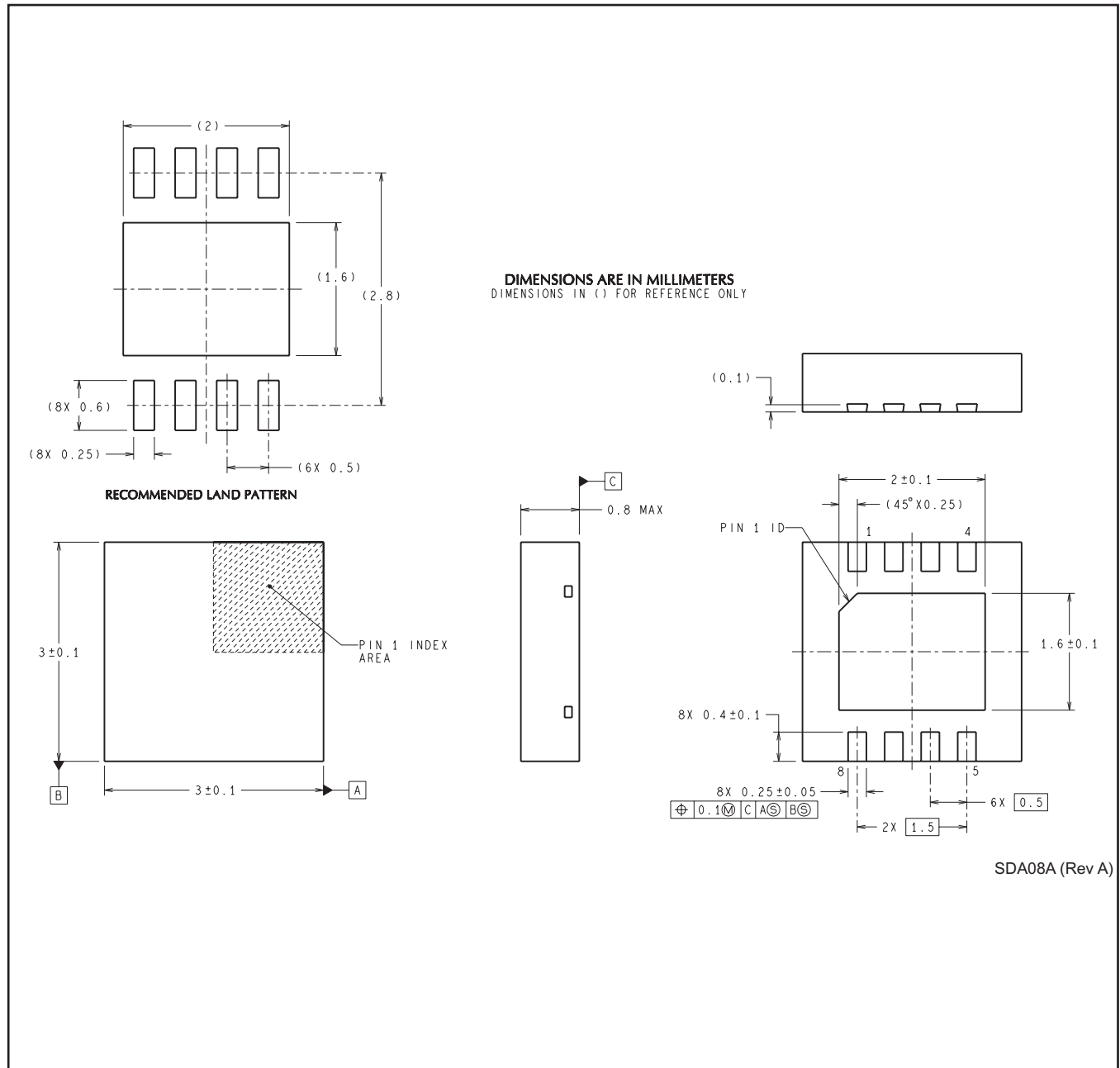

## IMPORTANT NOTICE

Texas Instruments Incorporated and its subsidiaries (TI) reserve the right to make corrections, enhancements, improvements and other changes to its semiconductor products and services per JESD46, latest issue, and to discontinue any product or service per JESD48, latest issue. Buyers should obtain the latest relevant information before placing orders and should verify that such information is current and complete. All semiconductor products (also referred to herein as "components") are sold subject to TI's terms and conditions of sale supplied at the time of order acknowledgment.

TI warrants performance of its components to the specifications applicable at the time of sale, in accordance with the warranty in TI's terms and conditions of sale of semiconductor products. Testing and other quality control techniques are used to the extent TI deems necessary to support this warranty. Except where mandated by applicable law, testing of all parameters of each component is not necessarily performed.

TI assumes no liability for applications assistance or the design of Buyers' products. Buyers are responsible for their products and applications using TI components. To minimize the risks associated with Buyers' products and applications, Buyers should provide adequate design and operating safeguards.

TI does not warrant or represent that any license, either express or implied, is granted under any patent right, copyright, mask work right, or other intellectual property right relating to any combination, machine, or process in which TI components or services are used. Information published by TI regarding third-party products or services does not constitute a license to use such products or services or a warranty or endorsement thereof. Use of such information may require a license from a third party under the patents or other intellectual property of the third party, or a license from TI under the patents or other intellectual property of TI.

Reproduction of significant portions of TI information in TI data books or data sheets is permissible only if reproduction is without alteration and is accompanied by all associated warranties, conditions, limitations, and notices. TI is not responsible or liable for such altered documentation. Information of third parties may be subject to additional restrictions.

Resale of TI components or services with statements different from or beyond the parameters stated by TI for that component or service voids all express and any implied warranties for the associated TI component or service and is an unfair and deceptive business practice. TI is not responsible or liable for any such statements.

Buyer acknowledges and agrees that it is solely responsible for compliance with all legal, regulatory and safety-related requirements concerning its products, and any use of TI components in its applications, notwithstanding any applications-related information or support that may be provided by TI. Buyer represents and agrees that it has all the necessary expertise to create and implement safeguards which anticipate dangerous consequences of failures, monitor failures and their consequences, lessen the likelihood of failures that might cause harm and take appropriate remedial actions. Buyer will fully indemnify TI and its representatives against any damages arising out of the use of any TI components in safety-critical applications.

In some cases, TI components may be promoted specifically to facilitate safety-related applications. With such components, TI's goal is to help enable customers to design and create their own end-product solutions that meet applicable functional safety standards and requirements. Nonetheless, such components are subject to these terms.

No TI components are authorized for use in FDA Class III (or similar life-critical medical equipment) unless authorized officers of the parties have executed a special agreement specifically governing such use.

Only those TI components which TI has specifically designated as military grade or "enhanced plastic" are designed and intended for use in military/aerospace applications or environments. Buyer acknowledges and agrees that any military or aerospace use of TI components which have **not** been so designated is solely at the Buyer's risk, and that Buyer is solely responsible for compliance with all legal and regulatory requirements in connection with such use.

TI has specifically designated certain components as meeting ISO/TS16949 requirements, mainly for automotive use. In any case of use of non-designated products, TI will not be responsible for any failure to meet ISO/TS16949.

### Products

Audio	<a href="http://www.ti.com/audio">www.ti.com/audio</a>
Amplifiers	<a href="http://amplifier.ti.com">amplifier.ti.com</a>
Data Converters	<a href="http://dataconverter.ti.com">dataconverter.ti.com</a>
DLP® Products	<a href="http://www.dlp.com">www.dlp.com</a>
DSP	<a href="http://dsp.ti.com">dsp.ti.com</a>
Clocks and Timers	<a href="http://www.ti.com/clocks">www.ti.com/clocks</a>
Interface	<a href="http://interface.ti.com">interface.ti.com</a>
Logic	<a href="http://logic.ti.com">logic.ti.com</a>
Power Mgmt	<a href="http://power.ti.com">power.ti.com</a>
Microcontrollers	<a href="http://microcontroller.ti.com">microcontroller.ti.com</a>
RFID	<a href="http://www.ti-rfid.com">www.ti-rfid.com</a>
OMAP Applications Processors	<a href="http://www.ti.com/omap">www.ti.com/omap</a>
Wireless Connectivity	<a href="http://www.ti.com/wirelessconnectivity">www.ti.com/wirelessconnectivity</a>

### Applications

Automotive and Transportation	<a href="http://www.ti.com/automotive">www.ti.com/automotive</a>
Communications and Telecom	<a href="http://www.ti.com/communications">www.ti.com/communications</a>
Computers and Peripherals	<a href="http://www.ti.com/computers">www.ti.com/computers</a>
Consumer Electronics	<a href="http://www.ti.com/consumer-apps">www.ti.com/consumer-apps</a>
Energy and Lighting	<a href="http://www.ti.com/energy">www.ti.com/energy</a>
Industrial	<a href="http://www.ti.com/industrial">www.ti.com/industrial</a>
Medical	<a href="http://www.ti.com/medical">www.ti.com/medical</a>
Security	<a href="http://www.ti.com/security">www.ti.com/security</a>
Space, Avionics and Defense	<a href="http://www.ti.com/space-avionics-defense">www.ti.com/space-avionics-defense</a>
Video and Imaging	<a href="http://www.ti.com/video">www.ti.com/video</a>

### TI E2E Community

[e2e.ti.com](http://e2e.ti.com)