

# PSoC<sup>®</sup> Programmable System-on-Chip

## Features

- Powerful Harvard-architecture processor:
  - M8C processor speeds up to 24 MHz
  - 8 × 8 multiply, 32-bit accumulate
  - Low power at high speed
  - 3.0 V to 5.25 V operating voltage
  - Industrial temperature range: -40 °C to +85 °C
- Advanced peripherals (PSoC<sup>®</sup> Blocks)
  - Six analog type “E” PSoC blocks provide:
    - Single or dual 8-Bit ADC
    - Comparators (up to four)
  - Up to eight digital PSoC blocks provide:
    - 8- to 32-bit timers and counters, 8- and 16-bit pulse-width modulators (PWMs)
    - One shot, multi-shot mode support in timers and PWMs
    - PWM with deadband support in one digital block
    - Shift register, CRC, and PRS modules
    - Full duplex UART
    - Multiple SPI masters or slaves, variable data length Support: 8- to 16-Bit
    - Can be connected to all GPIO pins
  - Complex peripherals by combining blocks
  - Shift function support for FSK detection
  - Powerful synchronize feature support. Analog module operations can be synchronized by digital blocks or external signals.
- High speed 10-bit SAR ADC with sample and hold optimized for embedded control
- Precision, programmable clocking:
  - Internal ± 5% 24/48 MHz oscillator across the industrial temperature range
  - High accuracy 24 MHz with optional 32 kHz crystal and PLL
  - Optional external oscillator, up to 24 MHz
  - Internal/external oscillator for watchdog and sleep
- Flexible on-chip memory:
  - Up to 16 KB flash program storage 50,000 erase/write cycles
  - Up to 1-KB SRAM data storage
  - In-system serial programming (ISSP)
  - Partial flash updates
  - Flexible protection modes
  - EEPROM emulation in flash
- Optimized CapSense<sup>®</sup> resource:
  - Two IDAC support up to 640 μA source current to replace external resistor
  - Two dedicated clock resources for CapSense:
    - CSD\_CLK: 1/2/4/8/16/32/128/256 derive from SYSCLK
    - CNT\_CLK: 1/2/4/8 Derive from CSD\_CLK
  - Dedicated 16-bit timers/counters for CapSense scanning
  - Support dual CSD channels simultaneous scanning

- Programmable pin configurations:
  - 25 mA sink, 10 mA source on all GPIOs
  - Pull-up, pull-down, high Z, Strong, or open-drain drive modes on all GPIOs
  - Up to 38 analog inputs on GPIOs
  - Configurable interrupt on all GPIOs
- Additional system resources:
  - I<sup>2</sup>C™ slave, master, and multimaster to 400 kHz
  - Supports hardware addressing feature
  - Watchdog and sleep timers
  - User configurable low voltage detection
  - Integrated supervisory circuit
  - On-Chip precision voltage reference
  - Supports RTC block into digital peripheral logic

## Top Level Block Diagram

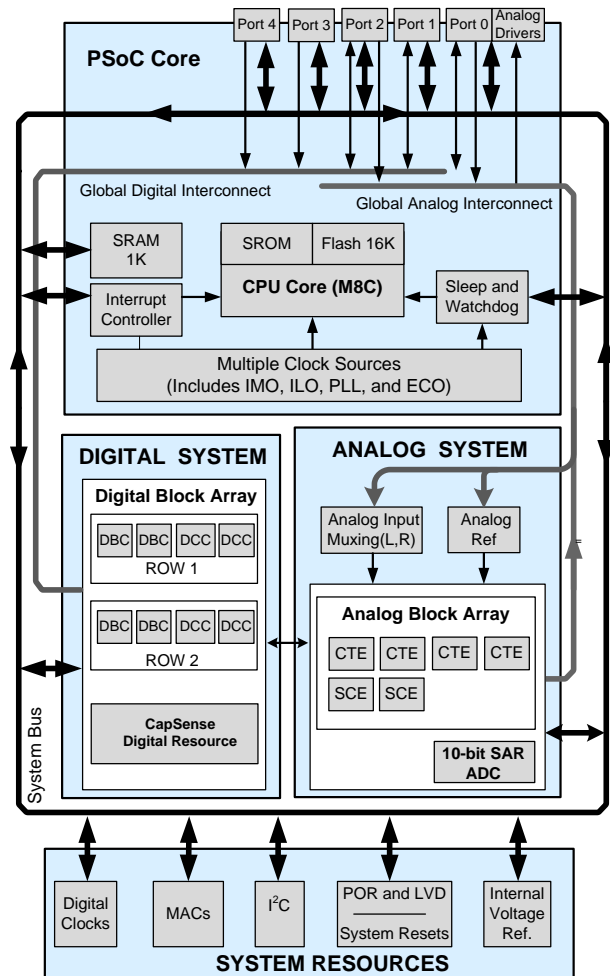

## Contents

<b>PSoC Functional Overview</b> .....	<b>3</b>	<b>Electrical Specifications</b> .....	<b>13</b>
PSoC Core .....	3	Absolute Maximum Ratings .....	14
Digital System .....	3	Operating Temperature .....	14
Analog System .....	4	DC Electrical Characteristics .....	15
Additional System Resources .....	4	AC Electrical Characteristics .....	21
PSoC Device Characteristics .....	5	<b>Packaging Information</b> .....	<b>27</b>
<b>Getting Started</b> .....	<b>5</b>	Thermal Impedances .....	28
Application Notes .....	5	Solder Reflow Specifications .....	28
Development Kits .....	5	<b>Ordering Information</b> .....	<b>28</b>
Training .....	5	Ordering Code Definitions .....	28
CYPros Consultants .....	5	<b>Acronyms</b> .....	<b>29</b>
Solutions Library .....	5	<b>Reference Documents</b> .....	<b>29</b>
Technical Support .....	5	<b>Document Conventions</b> .....	<b>30</b>
<b>Development Tools</b> .....	<b>6</b>	Units of Measure .....	30
PSoC Designer Software Subsystems .....	6	<b>Numeric Conventions</b> .....	<b>30</b>
<b>Designing with PSoC Designer</b> .....	<b>7</b>	<b>Glossary</b> .....	<b>30</b>
Select User Modules .....	7	<b>Appendix: Silicon Errata for the PSoC® CY8C21x45,</b>	
Configure User Modules .....	7	<b>CY8C22x45 Product Family</b> .....	<b>35</b>
Organize and Connect .....	7	Part Numbers Affected .....	35
Generate, Verify, and Debug .....	7	CY8C21x45, CY8C22x45 Qualification Status .....	35
<b>Pinouts</b> .....	<b>8</b>	Errata Summary .....	35
CY8C22345, CY8C21345 28-pin SOIC .....	8	<b>Document History Page</b> .....	<b>37</b>
CY8C22545 44-pin TQFP .....	9	<b>Sales, Solutions, and Legal Information</b> .....	<b>39</b>
<b>Registers</b> .....	<b>10</b>	Worldwide Sales and Design Support .....	39
Register Conventions .....	10	Products .....	39
Register Mapping Tables .....	10	PSoC Solutions .....	39

## PSoC Functional Overview

The PSoC family consists of many On-Chip Controller devices. These devices are designed to replace multiple traditional MCU-based system components with one low cost single-chip programmable device. PSoC devices include configurable blocks of analog and digital logic, and programmable interconnects. This architecture enables the user to create customized peripheral configurations that match the requirements of each individual application. Additionally, a fast CPU, Flash program memory, SRAM data memory, and configurable I/O are included in a range of convenient pinouts and packages.

The PSoC architecture, shown in [Figure 1](#), consists of four main areas: PSoC Core, Digital System, Analog System, and System Resources. Configurable global busing allows the combining of all the device resources into a complete custom system. The PSoC family can have up to five I/O ports connecting to the global digital and analog interconnects, providing access to eight digital blocks and six analog blocks.

### PSoC Core

The PSoC Core is a powerful engine that supports a rich feature set. The core includes a CPU, memory, clocks, and configurable general-purpose I/O (GPIO).

The M8C CPU core is a powerful processor with speeds up to 24 MHz, providing a four MIPS 8-bit Harvard architecture microprocessor. The CPU uses an interrupt controller with 21 vectors, to simplify the programming of real time embedded events.

Program execution is timed and protected using the included Sleep and watchdog timers (WDT).

Memory encompasses 16 KB of Flash for program storage, 1 K bytes of SRAM for data storage, and up to 2 KB of EEPROM emulated using the Flash. Program Flash uses four protection levels on blocks of 64 bytes, allowing customized software IP protection.

The PSoC device incorporates flexible internal clock generators, including a 24 MHz IMO (internal main oscillator). The 24 MHz IMO can also be doubled to 48 MHz for use by the digital system. A low power 32 kHz internal low-speed oscillator (ILO) is provided for the Sleep timer and WDT. If crystal accuracy is required, the ECO (32.768 kHz external crystal oscillator) is available for use as a Real Time Clock (RTC), and can optionally generate a crystal-accurate 24 MHz system clock using a PLL. The clocks, together with programmable clock dividers (as a System Resource), provide the flexibility to integrate almost any timing requirement into the PSoC device.

PSoC GPIOs provide connection to the CPU, digital, and analog resources of the device. Each pin's drive mode may be selected from eight options, allowing great flexibility in external interfacing. Every pin can also generate a system interrupt on high level, low level, and change from last read.

## Digital System

The Digital System is composed of eight digital PSoC blocks. Each block is an 8-bit resource that may be used alone or combined with other blocks to form 8, 16, 24, and 32-bit peripherals, which are called user module references.

**Figure 1. Digital System Block Diagram**

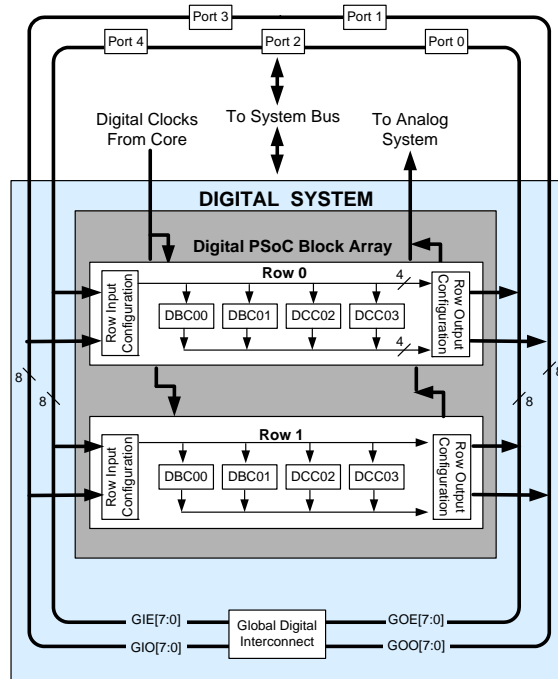

Digital peripheral configurations are:

- PWMs (8- and 16-Bit)
- PWMs with Dead band (8- and 16-Bit)
- Counters (8 to 32-Bit)
- Timers (8 to 32-Bit)
- UART 8 Bit with Selectable Parity (Up to Two)
- SPI Master and Slave (Up to Two)
- Shift Register (1 to 32-Bit)
- I2C Slave and Master (One Available as a System Resource)
- Cyclical Redundancy Checker/Generator (8 to 32-Bit)
- IrDA (Up to Two)
- Pseudo Random Sequence Generators (8 to 32-Bit)

The digital blocks may be connected to any GPIO through a series of global buses that can route any signal to any pin. The buses also allow for signal multiplexing and performing logic operations. This configurability frees your designs from the constraints of a fixed peripheral controller.

Digital blocks are provided in rows of four, where the number of blocks varies by PSoC device family. This provides a choice of system resources for your application. Family resources are shown in [Table 1 on page 5](#).

## Analog System

The Analog System consists of a 10-bit SAR ADC and six configurable blocks.

The programmable 10-bit SAR ADC is an optimized ADC that can be run up to 200 ksp/s with  $\pm 1.5$  LSB DNL and  $\pm 2.5$  LSB INL (true for  $V_{DD} \geq 3.0$  V and  $V_{ref} \geq 3.0$  V). External filters are required on ADC input channels for antialiasing. This ensures that any out-of-band content is not folded into the input signal band.

Reconfigurable analog resources allow creating complex analog signal flows. Analog peripherals are very flexible and may be customized to support specific application requirements. Some of the more common PSoC analog functions (most available as user modules) are:

- Analog-to-Digital converters (Single or Dual, with 8-bit resolution)
- Pin-to-pin Comparator
- Single ended comparators with absolute (1.3 V) reference or 5-bit DAC reference
- 1.3 V reference (as a System Resource)

Analog blocks are provided in columns of four, which include CT-E (Continuous Time) and SC-E (Switched Capacitor) blocks. These devices provide limited functionality Type “E” analog blocks.

**Figure 2. Analog System Block Diagram**

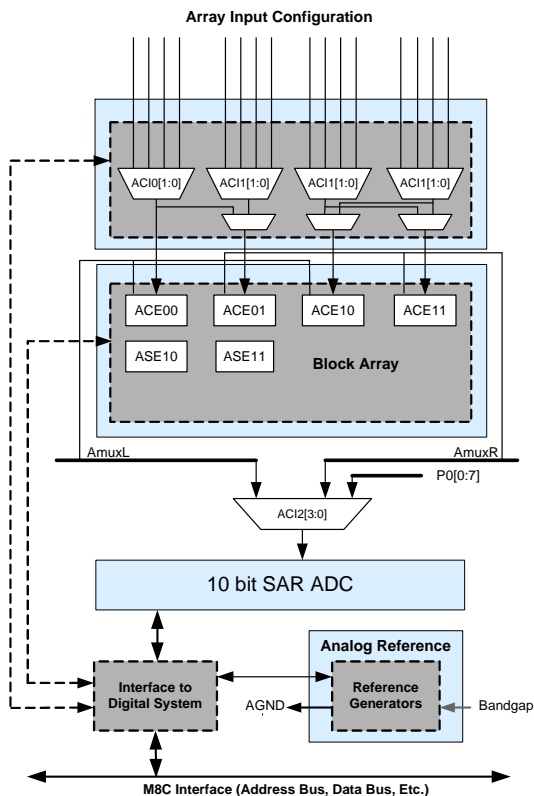

## Additional System Resources

System Resources, some of which are listed in the previous sections, provide additional capability useful to complete systems. Additional resources include a MAC, low voltage detection, and power on reset. The merits of each system resource are:

- Digital clock dividers provide three customizable clock frequencies for use in applications. The clocks may be routed to both the digital and analog systems. Additional clocks can be generated using digital PSoC blocks as clock dividers.
- Additional Digital resources and clocks optimized for CSD.
- Support “RTC” block into digital peripheral logic.
- A multiply accumulate (MAC) provides a fast 8-bit multiplier with 32-bit accumulate, to assist in both general math and digital filters.
- The I2C module provides 100 and 400 kHz communication over two wires. Slave, master, and multi-master modes are all supported.
- Low Voltage Detection (LVD) interrupts can signal the application of falling voltage levels, while the advanced POR (Power On Reset) circuit eliminates the need for a system supervisor.
- An internal 1.3 V reference provides an absolute reference for the analog system, including ADCs and DACs.

## PSoC Device Characteristics

Depending on your PSoC device characteristics, the digital and analog systems can have 16, 8, or 4 digital blocks and 12, 6, or 3 analog blocks. The following table lists the resources available for specific PSoC device groups.

**Table 1. PSoC Device Characteristics**

PSoC Part Number	Digital I/O	Digital Rows	Digital Blocks	Analog Inputs	Analog Outputs	Analog Columns	Analog Blocks	SRAM Size	Flash Size
CY8C29x66 <sup>[1]</sup>	up to 64	4	16	up to 12	4	4	12	2 K	32 K
CY8C28xxx	up to 44	up to 3	up to 12	up to 44	up to 4	up to 6	up to 12 + 4 <sup>[2]</sup>	1 K	16 K
CY8C27x43	up to 44	2	8	up to 12	4	4	12	256	16 K
CY8C24x94 <sup>[1]</sup>	up to 56	1	4	up to 48	2	2	6	1 K	16 K
CY8C24x23A <sup>[1]</sup>	up to 24	1	4	up to 12	2	2	6	256	4 K
CY8C23x33	up to 26	1	4	up to 12	2	2	4	256	8 K
CY8C22x45 <sup>[1]</sup>	up to 38	2	8	up to 38	0	4	6 <sup>[2]</sup>	1 K	16 K
CY8C21x45 <sup>[1]</sup>	up to 24	1	4	up to 24	0	4	6 <sup>[2]</sup>	512	8 K
CY8C21x34 <sup>[1]</sup>	up to 28	1	4	up to 28	0	2	4 <sup>[2]</sup>	512	8 K
CY8C21x23	up to 16	1	4	up to 8	0	2	4 <sup>[2]</sup>	256	4 K
CY8C20x34 <sup>[1]</sup>	up to 28	0	0	up to 28	0	0	3 <sup>[2,3]</sup>	512	8 K
CY8C20xx6	up to 36	0	0	up to 36	0	0	3 <sup>[2,3]</sup>	up to 2 K	up to 32 K

## Getting Started

For in-depth information, along with detailed programming details, see the *PSoC<sup>®</sup> Technical Reference Manual*.

For up-to-date ordering, packaging, and electrical specification information, see the latest [PSoC device datasheets](#) on the web.

### Application Notes

[Cypress application notes](#) are an excellent introduction to the wide variety of possible PSoC designs.

### Development Kits

[PSoC Development Kits](#) are available online from and through a growing number of regional and global distributors, which include Arrow, Avnet, Digi-Key, Farnell, Future Electronics, and Newark.

### Training

[Free PSoC technical training](#) (on demand, webinars, and workshops), which is available online via [www.cypress.com](http://www.cypress.com),

covers a wide variety of topics and skill levels to assist you in your designs.

### CYPros Consultants

Certified PSoC consultants offer everything from technical assistance to completed PSoC designs. To contact or become a PSoC consultant go to the [CYPros Consultants](#) web site.

### Solutions Library

Visit our growing [library of solution focused designs](#). Here you can find various application designs that include firmware and hardware design files that enable you to complete your designs quickly.

### Technical Support

[Technical support](#) – including a searchable Knowledge Base articles and technical forums – is also available online. If you cannot find an answer to your question, call our Technical Support hotline at 1-800-541-4736.

#### Notes

1. Automotive qualified devices available in this group.
2. Limited analog functionality.
3. Two analog blocks and one CapSense<sup>®</sup> block.

## Development Tools

PSoC Designer™ is the revolutionary integrated design environment (IDE) that you can use to customize PSoC to meet your specific application requirements. PSoC Designer software accelerates system design and time to market. Develop your applications using a library of precharacterized analog and digital peripherals (called user modules) in a drag-and-drop design environment. Then, customize your design by leveraging the dynamically generated application programming interface (API) libraries of code. Finally, debug and test your designs with the integrated debug environment, including in-circuit emulation and standard software debug features. PSoC Designer includes:

- Application editor graphical user interface (GUI) for device and user module configuration and dynamic reconfiguration
- Extensive user module catalog
- Integrated source-code editor (C and assembly)
- Free C compiler with no size restrictions or time limits
- Built-in debugger
- In-circuit emulation
- Built-in support for communication interfaces:
  - Hardware and software I<sup>2</sup>C slaves and masters
  - Full-speed USB 2.0
  - Up to four full-duplex universal asynchronous receiver/transmitters (UARTs), SPI master and slave, and wireless

PSoC Designer supports the entire library of PSoC 1 devices and runs on Windows XP, Windows Vista, and Windows 7.

## PSoC Designer Software Subsystems

### *Design Entry*

In the chip-level view, choose a base device to work with. Then select different onboard analog and digital components that use the PSoC blocks, which are called user modules. Examples of user modules are ADCs, DACs, amplifiers, and filters. Configure the user modules for your chosen application and connect them to each other and to the proper pins. Then generate your project. This prepopulates your project with APIs and libraries that you can use to program your application.

The tool also supports easy development of multiple configurations and dynamic reconfiguration. Dynamic reconfiguration makes it possible to change configurations at run

time. In essence, this allows you to use more than 100 percent of PSoC's resources for an application.

### *Code Generation Tools*

The code generation tools work seamlessly within the PSoC Designer interface and have been tested with a full range of debugging tools. You can develop your design in C, assembly, or a combination of the two.

**Assemblers.** The assemblers allow you to merge assembly code seamlessly with C code. Link libraries automatically use absolute addressing or are compiled in relative mode, and are linked with other software modules to get absolute addressing.

**C Language Compilers.** C language compilers are available that support the PSoC family of devices. The products allow you to create complete C programs for the PSoC family devices. The optimizing C compilers provide all of the features of C, tailored to the PSoC architecture. They come complete with embedded libraries providing port and bus operations, standard keypad and display support, and extended math functionality.

### *Debugger*

PSoC Designer has a debug environment that provides hardware in-circuit emulation, allowing you to test the program in a physical system while providing an internal view of the PSoC device. Debugger commands allow you to read and program and read and write data memory, and read and write I/O registers. You can read and write CPU registers, set and clear breakpoints, and provide program run, halt, and step control. The debugger also allows you to create a trace buffer of registers and memory locations of interest.

### *Online Help System*

The online help system displays online, context-sensitive help. Designed for procedural and quick reference, each functional subsystem has its own context-sensitive help. This system also provides tutorials and links to FAQs and an online support Forum to aid the designer.

### *In-Circuit Emulator*

A low-cost, high-functionality in-circuit emulator (ICE) is available for development support. This hardware can program single devices.

The emulator consists of a base unit that connects to the PC using a USB port. The base unit is universal and operates with all PSoC devices. Emulation pods for each device family are available separately. The emulation pod takes the place of the PSoC device in the target board and performs full-speed (24 MHz) operation.

## Designing with PSoC Designer

The development process for the PSoC device differs from that of a traditional fixed function microprocessor. The configurable analog and digital hardware blocks give the PSoC architecture a unique flexibility that pays dividends in managing specification change during development and by lowering inventory costs. These configurable resources, called PSoC Blocks, have the ability to implement a wide variety of user-selectable functions. The PSoC development process is summarized in four steps:

1. Select [User Modules](#).
2. Configure User Modules.
3. Organize and Connect.
4. Generate, Verify, and Debug.

### Select User Modules

PSoC Designer provides a library of prebuilt, pretested hardware peripheral components called “user modules.” User modules make selecting and implementing peripheral devices, both analog and digital, simple.

### Configure User Modules

Each user module that you select establishes the basic register settings that implement the selected function. They also provide parameters and properties that allow you to tailor their precise configuration to your particular application. For example, a PWM User Module configures one or more digital PSoC blocks, one for each 8 bits of resolution. The user module parameters permit you to establish the pulse width and duty cycle. Configure the parameters and properties to correspond to your chosen application. Enter values directly or by selecting values from drop-down menus. All the user modules are documented in datasheets that may be viewed directly in PSoC Designer or on the Cypress website. These [user module datasheets](#) explain the internal operation of the user module and provide performance

specifications. Each datasheet describes the use of each user module parameter, and other information you may need to successfully implement your design.

### Organize and Connect

You build signal chains at the chip level by interconnecting user modules to each other and the I/O pins. You perform the selection, configuration, and routing so that you have complete control over all on-chip resources.

### Generate, Verify, and Debug

When you are ready to test the hardware configuration or move on to developing code for the project, you perform the “Generate Configuration Files” step. This causes PSoC Designer to generate source code that automatically configures the device to your specification and provides the software for the system. The generated code provides application programming interfaces (APIs) with high-level functions to control and respond to hardware events at run-time and interrupt service routines that you can adapt as needed.

A complete code development environment allows you to develop and customize your applications in either C, assembly language, or both.

The last step in the development process takes place inside PSoC Designer’s debugger (access by clicking the Connect icon). PSoC Designer downloads the HEX image to the ICE where it runs at full speed. PSoC Designer debugging capabilities rival those of systems costing many times more. In addition to traditional single-step, run-to-breakpoint, and watch-variable features, the debug interface provides a large trace buffer and allows you to define complex breakpoint events. These include monitoring address and data bus values, memory locations, and external signals.

## Pinouts

This PSoC device family is available in a variety of packages that are listed in the following tables. Every port pin (labeled with a “P”) is capable of Digital I/O. However, Vss, Vdd, and XRES are not capable of Digital I/O.

### CY8C22345, CY8C21345 28-pin SOIC

**Table 2. Pin Definitions**

Pin No.	Type		Pin Name	Description
	Digital	Analog		
1	I/O	I, MR	P0[7]	Integration Capacitor for MR
2	I/O	I, ML	P0[5]	Integration Capacitor for ML
3	I/O	I, ML	P0[3]	
4	I/O	I, ML	P0[1]	
5	I/O	I, ML	P2[7]	To Compare Column 0
6	I/O	ML	P2[5]	Optional ADC External Vref
7	I/O	ML	P2[3]	
8	I/O	ML	P2[1]	
9	Power		Vss	Ground Connection
10	I/O	ML	P1[7]	I2C serial clock (SCL)
11	I/O	ML	P1[5]	I2C serial data (SDA)
12	I/O	ML	P1[3]	
13	I/O	ML	P1[1]	I2C serial clock (SCL), ISSP-SCLK <sup>[4]</sup>
14	Power		Vss	Ground Connection
15	I/O	MR	P1[0]	I2C serial Clock (SCL), ISSP-SDATA <sup>[4]</sup>
16	I/O	MR	P1[2]	
17	I/O	MR	P1[4]	Optional external clock input (EXT-CLK)
18	I/O	MR	P1[6]	
19	Input		XRES	Active High Pin Reset with Internal Pull Down
20	I/O	MR	P2[0]	
21	I/O	MR	P2[2]	
22	I/O	MR	P2[4]	
23	I/O	I, MR	P2[6]	To Compare Column 1
24	I/O	I, MR	P0[0]	
25	I/O	I, MR	P0[2]	
26	I/O	I, MR	P0[4]	
27	I/O	I, MR	P0[6]	
28	Power		Vdd	Supply Voltage

**Figure 3. Pin Diagram**

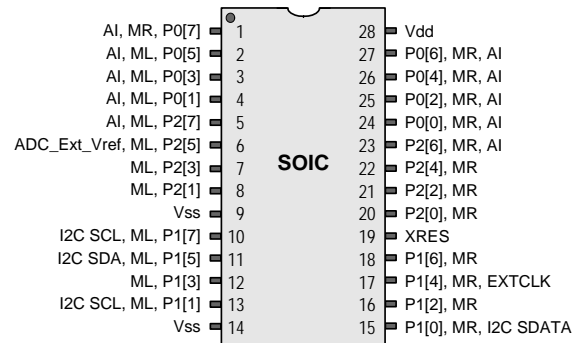

**LEGEND:** A = Analog, I = Input, O = Output, M=Analog Mux input, MR= Analog Mux right input, ML= Analog Mux left input.

**Note**

4. ISSP pin which is not HI-Z at POR.



**CY8C22545 44-pin TQFP**

**Table 3. Pin Definitions**

Pin No.	Type		Pin Name	Description
	Digital	Analog		
1	I/O	ML	P2[5]	Optional ADC External Vref
2	I/O	ML	P2[3]	
3	I/O	ML	P2[1]	
4	Power		Vdd	Supply Voltage
5	I/O	ML	P4[5]	
6	I/O	ML	P4[3]	
7	I/O	ML	P4[1]	
8	Power		Vss	Ground Connection
9	I/O	ML	P3[7]	
10	I/O	ML	P3[5]	
11	I/O	ML	P3[3]	
12	I/O	ML	P3[1]	
13	I/O	ML	P1[7]	I2C serial clock (SCL)
14	I/O	ML	P1[5]	I2C serial data (SDA)
15	I/O	ML	P1[3]	
16	I/O	ML	P1[1]	Crystal (XTALin), I2C SCL, TC SCLK <sup>[4]</sup>
17	Power		Vss	Ground Connection
18	I/O	MR	P1[0]	Crystal (XTALout), I2C SDA, TC SCLK <sup>[4]</sup>
19	I/O	MR	P1[2]	
20	I/O	MR	P1[4]	Optional external clock input (EXTCLK)
21	I/O	MR	P1[6]	
22	I/O	MR	P3[0]	
23	I/O	MR	P3[2]	
24	I/O	MR	P3[4]	
25	I/O	MR	P3[6]	
26	Input		XRES	Active High Pin Reset with Internal Pull Down
27	I/O	MR	P4[0]	
28	I/O	MR	P4[2]	
29	I/O	MR	P4[4]	
30	Power		Vss	Ground Connection
31	I/O	MR	P2[0]	
32	I/O	MR	P2[2]	
33	I/O	MR	P2[4]	
34	I/O	I, MR	P2[6]	To Compare Column 1
35	I/O	I, MR	P0[0]	
36	I/O	I, MR	P0[2]	
37	I/O	I, MR	P0[4]	
38	I/O	I, MR	P0[6]	
39	Power		Vdd	Supply Voltage
40	I/O	I, MR	P0[7]	Integration Capacitor for MR
41	I/O	I, ML	P0[5]	Integration Capacitor for ML
42	I/O	I, ML	P0[3]	
43	I/O	I, ML	P0[1]	
44	I/O	I, ML	P2[7]	To Compare Column 0

**Figure 4. Pin Diagram**

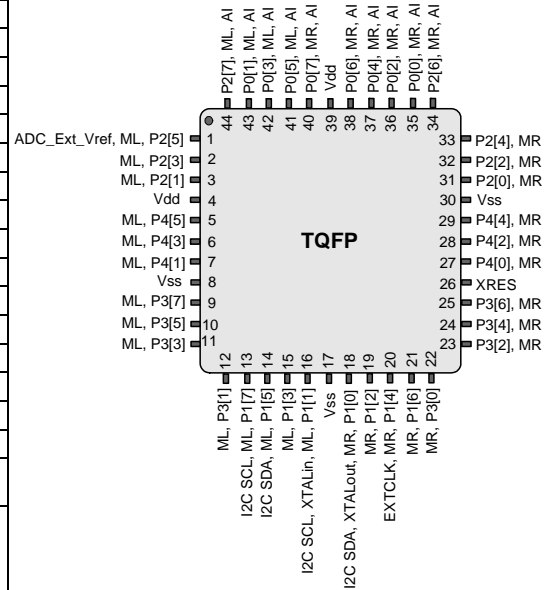

**LEGEND:** A = Analog, I = Input, O = Output, M=Analog Mux input, MR= Analog Mux right input, ML= Analog Mux left input.

## Registers

This section lists the registers of this PSoC device family by mapping tables. For detailed register information, refer the *PSoC Programmable System-on Chip Technical Reference Manual*.

### Register Conventions

**Table 4. Abbreviations**

Convention	Description
RW	Read and write register or bit(s)
R	Read register or bit(s)
W	Write register or bit(s)
L	Logical register or bit(s)
C	Clearable register or bit(s)
#	Access is bit specific

### Register Mapping Tables

The PSoC device has a total register address space of 512 bytes. The register space is also referred to as I/O space and is broken into two parts. The XIO bit in the Flag register determines which bank the user is currently in. When the XIO bit is set, the user is said to be in the “extended” address space or the “configuration” registers.

**Note** In the following register mapping tables, blank fields are Reserved and must not be accessed.

Table 5. Register Map Bank 0 Table: User Space

Name	Addr (0,Hex)	Access	Name	Addr (0,Hex)	Access	Name	Addr (0,Hex)	Access	Name	Addr (0,Hex)	Access
PRT0DR	00	RW		40	#	ASC10CR0*	80*	RW		C0	RW
PRT0IE	01	RW		41	W					C1	RW
PRT0GS	02	RW		42	RW					C2	RW
PRT0DM2	03	RW		43	#					C3	RW
PRT1DR	04	RW		44	#	ASD11CR0*	84*	RW		C4	RW
PRT1IE	05	RW		45	W					C5	RW
PRT1GS	06	RW		46	RW					C6	RW
PRT1DM2	07	RW		47	#					C7	RW
PRT2DR	08	RW		48	#				PWMVREF0	C8	#
PRT2IE	09	RW		49	W				PWMVREF1	C9	#
PRT2GS	0A	RW		4A	RW				IDAC_MODE	CA	RW
PRT2DM2	0B	RW		4B	#				PWM_SRC	CB	#
PRT3DR	0C	RW		4C	#				TS_CR0	CC	RW
PRT3IE	0D	RW		4D	W				TS_CMPH	CD	RW
PRT3GS	0E	RW		4E	RW				TS_Cmpl	CE	RW
PRT3DM2	0F	RW		4F	#				TS_CR1	CF	RW
PRT4DR	10	RW	CSD0_DR0_L	50	R		90	RW	CUR_PP	D0	RW
PRT4IE	11	RW	CSD0_DR1_L	51	W		91	RW	STK_PP	D1	RW
PRT4GS	12	RW	CSD0_CNT_L	52	R		92	RW	PRV_PP	D2	RW
PRT4DM2	13	RW	CSD0_CR0	53	#		93	RW	IDX_PP	D3	RW
	14	RW	CSD0_DR0_H	54	R		94	RW	MVR_PP	D4	RW
	15	RW	CSD0_DR1_H	55	W		95	RW	MVW_PP	D5	RW
	16	RW	CSD0_CNT_H	56	R		96	RW	I2C0_CFG	D6	RW
	17	RW	CSD0_CR1	57	RW		97	RW	I2C0_SCR	D7	#
	18	RW	CSD1_DR0_L	58	R		98	RW	I2C0_DR	D8	RW
	19	RW	CSD1_DR1_L	59	W		99	RW	I2C0_MSCR	D9	#
	1A	RW	CSD1_CNT_L	5A	R		9A	RW	INT_CLR0	DA	RW
	1B	RW	CSD1_CR0	5B	#		9B	RW	INT_CLR1	DB	RW
	1C	RW	CSD1_DR0_H	5C	R		9C	RW	INT_CLR2	DC	RW
	1D	RW	CSD1_DR1_H	5D	W		9D	RW	INT_CLR3	DD	RW
	1E	RW	CSD1_CNT_H	5E	R		9E	RW	INT_MSK3	DE	RW
	1F	RW	CSD_CR1	5F	RW		9F	RW	INT_MSK2	DF	RW
DBC00DR0	20	#	AMX_IN	60	RW		A0		INT_MSK0	E0	RW
DBC00DR1	21	W	AMUX_CFG	61	RW		A1		INT_MSK1	E1	RW
DBC00DR2	22	RW	PWM_CR	62	RW		A2		INT_VC	E2	RC
DBC00CR0	23	#	ARF_CR	63	RW		A3		RES_WDT	E3	W
DBC01DR0	24	#	CMP_CR0	64	#		A4		DEC_DH	E4	RW
DBC01DR1	25	W	ASY_CR	65	#		A5		DEC_DL	E5	RW
DBC01DR2	26	RW	CMP_CR1	66	RW		A6		DEC_CR0*	E6	RW
DBC01CR0	27	#		67	RW		A7		DEC_CR1*	E7	RW
DCC02DR0	28	#	ADC0_CR	68	#		A8	W	MUL0_X	E8	W
DCC02DR1	29	W	ADC1_CR	69	#		A9	W	MUL0_Y	E9	W
DCC02DR2	2A	RW	SADC_DH	6A	RW		AA	R	MUL0_DH	EA	R
DCC02CR0	2B	#	SADC_DL	6B	RW		AB	R	MUL0_DL	EB	R
DCC03DR0	2C	#	TMP_DR0	6C	RW		AC	RW	ACC0_DR1	EC	RW
DCC03DR1	2D	W	TMP_DR1	6D	RW		AD	RW	ACC0_DR0	ED	RW
DCC03DR2	2E	RW	TMP_DR2	6E	RW		AE	RW	ACC0_DR3	EE	RW
DCC03CR0	2F	#	TMP_DR3	6F	RW		AF	RW	ACC0_DR2	EF	RW
DBC10DR0	30	#		70	RW	RDI0RI	B0	RW	CPU_A	F0	#
DBC10DR1	31	W		71	RW	RDI0SYN	B1	RW	CPU_T1	F1	#
DBC10DR2	32	RW	ACB00CR1*	72*	RW	RDI0IS	B2	RW	CPU_T2	F2	#
DBC10CR0	33	#	ACB00CR2*	73*	RW	RDI0LT0	B3	RW	CPU_X	F3	#
DBC11DR0	34	#		74	RW	RDI0LT1	B4	RW	CPU_PCL	F4	#
DBC11DR1	35	W		75	RW	RDI0RO0	B5	RW	CPU_PCH	F5	#
DBC11DR2	36	RW	ACB01CR1*	76*	RW	RDI0RO1	B6	RW	CPU_SP	F6	#
DBC11CR0	37	#	ACB01CR2*	77*	RW	RDI0DSM	B7	RW	CPU_F	F7	I
DCC12DR0	38	#		78	RW	RDI1RI	B8	RW	CPU_TST0	F8	RW
DCC12DR1	39	W		79	RW	RDI1SYN	B9	RW	CPU_TST1	F9	RW
DCC12DR2	3A	RW		7A	RW	RDI1IS	BA	RW	CPU_TST2	FA	RW
DCC12CR0	3B	#		7B	RW	RDI1LT0	BB	RW	CPU_TST3	FB	#
DCC13DR0	3C	#		7C	RW	RDI1LT1	BC	RW	DAC1_D	FC	RW
DCC13DR1	3D	W		7D	RW	RDI1RO0	BD	RW	DAC0_D	FD	RW
DCC13DR2	3E	RW		7E	RW	RDI1RO1	BE	RW	CPU_SCR1	FE	#
DCC13CR0	3F	#		7F	RW	RDI1DSM	BF	RW	CPU_SCR0	FF	#

Shaded fields are Reserved and must not be accessed.

# Access is bit specific. \* has a different meaning.

Table 6. Register Map Bank 1 Table: Configuration Space

Name	Addr (1,Hex)	Access	Name	Addr (1,Hex)	Access	Name	Addr (1,Hex)	Access	Name	Addr (1,Hex)	Access
PRT0DM0	0	RW		40	RW	ASC10CR0*	80*	RW		C0	RW
PRT0DM1	1	RW		41	RW		81	RW		C1	RW
PRT0IC0	2	RW		42	RW		82	RW		C2	RW
PRT0IC1	3	RW		43	RW		83	RW		C3	RW
PRT1DM0	4	RW		44	RW	ASD11CR0*	84*	RW		C4	RW
PRT1DM1	5	RW		45	RW		85	RW		C5	RW
PRT1IC0	6	RW		46	RW		86	RW		C6	RW
PRT1IC1	7	RW		47	RW		87	RW		C7	RW
PRT2DM0	8	RW		48	RW		88	RW		C8	#
PRT2DM1	9	RW		49	RW		89	RW		C9	RW
PRT2IC0	0A	RW		4A	RW		8A	RW		CA	RW
PRT2IC1	0B	RW		4B	RW		8B	RW		CB	RW
PRT3DM0	0C	RW		4C	RW		8C	RW		CC	#
PRT3DM1	0D	RW		4D	RW		8D	RW		CD	RW
PRT3IC0	0E	RW		4E	RW		8E	RW		CE	RW
PRT3IC1	0F	RW		4F	RW		8F	RW		CF	RW
PRT4DM0	10	RW	CMP0CR1	50	RW		90	RW	GDI_O_IN	D0	RW
PRT4DM1	11	RW	CMP0CR2	51	RW		91	RW	GDI_E_IN	D1	RW
PRT4IC0	12	RW		52	RW		92	RW	GDI_O_OU	D2	RW
PRT4IC1	13	RW	VDAC50CR0	53	RW		93	RW	GDI_E_OU	D3	RW
	14	RW	CMP1CR1	54	RW		94	RW		D4	RW
	15	RW	CMP1CR2	55	RW		95	RW		D5	RW
	16	RW		56	RW		96	RW		D6	RW
	17	RW	VDAC51CR0	57	RW		97	RW		D7	RW
	18	RW	CSCMPCR0	58	#		98	RW	MUX_CR0	D8	RW
	19	RW	CSCMPGOEN	59	RW		99	RW	MUX_CR1	D9	RW
	1A	RW	CSLUTCR0	5A	RW		9A	RW	MUX_CR2	DA	RW
	1B	RW	CMPCOLMUX	5B	RW		9B	RW	MUX_CR3	DB	RW
	1C	RW	CMPPWMCR	5C	RW		9C	RW	DAC_CR1#	DC	RW
	1D	RW	CMPFLTCR	5D	RW		9D	RW	OSC_GO_EN	DD	RW
	1E	RW	CMPCLK1	5E	RW		9E	RW	OSC_CR4	DE	RW
	1F	RW	CMPCLK0	5F	RW		9F	RW	OSC_CR3	DF	RW
DBC00FN	20	RW	CLK_CR0	60	RW	GDI_O_IN_CR	A0	RW	OSC_CR0	E0	RW
DBC00IN	21	RW	CLK_CR1	61	RW	GDI_E_IN_CR	A1	RW	OSC_CR1	E1	RW
DBC00OU	22	RW	ABF_CR0	62	RW	GDI_O_OU_CR	A2	RW	OSC_CR2	E2	RW
DBC00CR1	23	RW	AMD_CR0	63	RW	GDI_E_OU_CR	A3	RW	VLI_CR	E3	RW
DBC01FN	24	RW	CMP_GO_EN	64	RW	RTC_H	A4	RW	VLI_CMP	E4	R
DBC01IN	25	RW	CMP_GO_EN1	65	RW	RTC_M	A5	RW	ADC0_TR*	E5	RW
DBC01OU	26	RW	AMD_CR1	66	RW	RTC_S	A6	RW	VDC1_TR*	E6	RW
DBC01CR1	27	RW	ALI_CR0	67	RW	RTC_CR	A7	RW	V2BG_TR	E7	RW
DCC02FN	28	RW	ALI_CR1	68	RW	SADC_CR0	A8	RW	IMO_TR	E8	W
DCC02IN	29	RW	CLK_CR2	69	RW	SADC_CR1	A9	RW	ILO_TR	E9	W
DCC02OU	2A	RW		6A	RW	SADC_CR2	AA	RW	BDG_TR	EA	RW
DBC02CR1	2B	RW	CLK_CR3	6B	RW	SADC_CR31RIM	AB	RW	ECO_TR	EB	W
DCC03FN	2C	RW	TMP_DR0	6C	RW	SADC_CR4	AC	RW	MUX_CR4	EC	RW
DCC03IN	2D	RW	TMP_DR1	6D	RW	I2C0_AD	AD	RW	MUX_CR5	ED	RW
DCC03OU	2E	RW	TMP_DR2	6E	RW		AE	RW	MUX_CR6	EE	RW
DBC03CR1	2F	RW	TMP_DR3	6F	RW		AF	RW	MUX_CR7	EF	RW
DBC10FN	30	RW		70	RW	RDI0RI	B0	RW	CPU_A	F0	#
DBC10IN	31	RW		71	RW	RDI0SYN	B1	RW	CPU_11	F1	#
DBC10OU	32	RW	ACB00CR1*	72	RW	RDI0IS	B2	RW	CPU_12	F2	#
DBC10CR1	33	RW	ACB00CR2*	73	RW	RDI0LT0	B3	RW	CPU_X	F3	#
DBC11FN	34	RW		74	RW	RDI0LT1	B4	RW	CPU_PCL	F4	#
DBC11IN	35	RW		75	RW	RDI0RO0	B5	RW	CPU_PCH	F5	#
DBC11OU	36	RW	ACB01CR1*	76*	RW	RDI0RO1	B6	RW	CPU_SP	F6	#
DBC11CR1	37	RW	ACB01CR2*	77*	RW	RDI0DSM	B7	RW	CPU_F	F7	I
DCC12FN	38	RW		78	RW	RDI1TRI	B8	RW	FLS_PRO	F8	RW
DCC12IN	39	RW		79	RW	RDI1SYN	B9	RW	FLS_TR	F9	W
DCC12OU	3A	RW		7A	RW	RDI1TS	BA	RW	FLS_PRT	FA	RW
DBC12CR1	3B	RW		7B	RW	RDI1LT0	BB	RW		FB	
DCC13FN	3C	RW		7C	RW	RDI1LT1	BC	RW	FAC_CR0	FC	SW
DCC13IN	3D	RW		7D	RW	RDI1TRO0	BD	RW	DAC_CR0#	FD	RW
DCC13OU	3E	RW		7E	RW	RDI1TRO1	BE	RW	CPU_SCR1	FE	#
DBC13CR1	3F	RW		7F	RW	RDI1DSM	BF	RW	CPU_SCR0	FF	#

Shaded fields are Reserved and must not be accessed.

# Access is bit specific. \* has a different meaning.

## Electrical Specifications

This section presents the DC and AC electrical specifications of this PSoC device family. For the latest electrical specifications, check the most recent data sheet by visiting <http://www.cypress.com>.

Specifications are valid for  $-40\text{ }^{\circ}\text{C} \leq T_A \leq 85\text{ }^{\circ}\text{C}$  and  $T_J \leq 100\text{ }^{\circ}\text{C}$ , except where noted. Specifications for devices running at greater than 12 MHz are valid for  $-40\text{ }^{\circ}\text{C} \leq T_A \leq 70\text{ }^{\circ}\text{C}$  and  $T_J \leq 82\text{ }^{\circ}\text{C}$ .

**Figure 5. Voltage versus Operating Frequency**

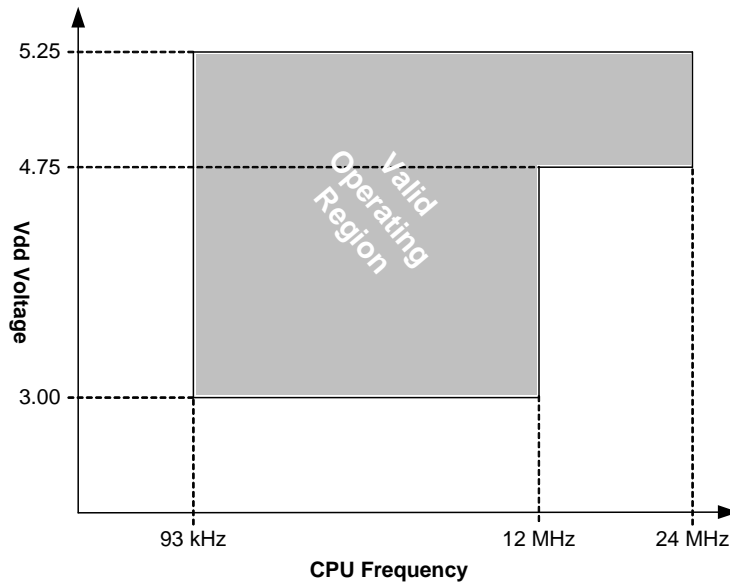

## Absolute Maximum Ratings

Exceeding maximum ratings may shorten the useful life of the device. User guidelines are not tested.

**Table 7. Absolute Maximum Ratings**

Symbol	Description	Min	Typ	Max	Units	Notes
T <sub>STG</sub>	Storage temperature	-55	-	+100	°C	Higher storage temperatures reduce data retention time
T <sub>BAKETEMP</sub>	Bake temperature	-	125	See Package label	°C	
T <sub>BAKETIME</sub>	Bake time	See package label	-	72	Hours	
T <sub>A</sub>	Ambient temperature with power applied	-40	-	+85	°C	
V <sub>dd</sub>	Supply voltage on V <sub>dd</sub> relative to V <sub>ss</sub>	-0.5	-	+6.0	V	
V <sub>IO</sub>	DC input voltage	V <sub>ss</sub> - 0.5	-	V <sub>dd</sub> + 0.5	V	
V <sub>IOz</sub>	DC voltage applied to tristate	V <sub>ss</sub> - 0.5	-	V <sub>dd</sub> + 0.5	V	
I <sub>MIO</sub>	Maximum current into any port pin	-25	-	+50	mA	
ESD	Electr static discharge voltage	2000	-	-	V	Human Body Model ESD
LU	Latch up current	-	-	200	mA	

## Operating Temperature

**Table 8. Operating Temperature**

Symbol	Description	Min	Typ	Max	Units	Notes
T <sub>A</sub>	Ambient temperature	-40	-	+85	°C	
T <sub>J</sub>	Junction temperature	-40	-	+100	°C	The temperature rise from ambient to junction is package specific. See <a href="#">Table 29 on page 28</a> . The user must limit the power consumption to comply with this requirement.

## DC Electrical Characteristics

### DC Chip Level Specifications

Table 9 lists the guaranteed maximum and minimum specifications for the voltage and temperature ranges: 4.75 V to 5.25 V and  $-40\text{ }^{\circ}\text{C} \leq T_A \leq 85\text{ }^{\circ}\text{C}$ , or 3.0 V to 3.6 V and  $-40\text{ }^{\circ}\text{C} \leq T_A \leq 85\text{ }^{\circ}\text{C}$ , respectively. Typical parameters apply to 5 V and 3.3 V at 25 °C, and are for design guidance only, unless specified otherwise.

**Table 9. DC Chip Level Specifications**

Symbol	Description	Min	Typ	Max	Units	Notes
V <sub>DD</sub>	Supply voltage	3.0	–	5.25	V	See Table 16 on page 19
I <sub>DD</sub>	Supply current	–	7	12	mA	Conditions are V <sub>DD</sub> = 5.0 V, 25°C, CPU = 3 MHz, 48 MHz disabled. VC1 = 1.5 MHz VC2 = 93.75 kHz VC3 = 93.75 kHz
I <sub>DD3</sub>	Supply current	–	4	7	mA	Conditions are V <sub>DD</sub> = 3.3 V T <sub>A</sub> = 25 °C, CPU = 3 MHz 48 MHz = Disabled VC1 = 1.5 MHz, VC2 = 93.75 kHz VC3 = 93.75 kHz
I <sub>SB</sub>	Sleep (Mode) Current with POR, LVD, Sleep Timer, and WDT <sup>[5]</sup>	–	3	6.5	μA	Conditions are with internal slow speed oscillator, V <sub>DD</sub> = 3.3 V $-40\text{ }^{\circ}\text{C} \leq T_A \leq 55\text{ }^{\circ}\text{C}$
I <sub>SBH</sub>	Sleep (Mode) Current with POR, LVD, Sleep Timer, and WDT at high temperature <sup>[5]</sup>	–	4	25	μA	Conditions are with internal slow speed oscillator, V <sub>DD</sub> = 3.3 V $55\text{ }^{\circ}\text{C} < T_A \leq 85\text{ }^{\circ}\text{C}$
I <sub>SBXTL</sub>	Sleep (Mode) Current with POR, LVD, Sleep Timer, WDT, and external crystal <sup>[5]</sup>	–	4	7.5	μA	Conditions are with properly loaded, 1 μW max, 32.768 kHz crystal. V <sub>DD</sub> = 3.3 V, $-40\text{ }^{\circ}\text{C} \leq T_A \leq 55\text{ }^{\circ}\text{C}$
I <sub>SBXTLH</sub>	Sleep (Mode) Current with POR, LVD, Sleep Timer, WDT, and external crystal at high temperature <sup>[5]</sup>	–	5	26	μA	Conditions are with properly loaded, 1 μW max, 32.768 kHz crystal. V <sub>DD</sub> = 3.3 V, $55\text{ }^{\circ}\text{C} < T_A \leq 85\text{ }^{\circ}\text{C}$
V <sub>REF</sub>	Reference Voltage (Bandgap)	1.275	1.3	1.325	V	Trimmed for appropriate V <sub>DD</sub>

#### Note

5. Standby current includes all functions (POR, LVD, WDT, Sleep Time) needed for reliable system operation. This must be compared with devices that have similar functions enabled.

*DC GPIO Specifications*

Table 10 lists the guaranteed maximum and minimum specifications for the voltage and temperature ranges: 4.75 V to 5.25 V and  $-40\text{ }^{\circ}\text{C} \leq T_A \leq 85\text{ }^{\circ}\text{C}$ , or 3.0 V to 3.6 V and  $-40\text{ }^{\circ}\text{C} \leq T_A \leq 85\text{ }^{\circ}\text{C}$ , respectively. Typical parameters apply to 5 V and 3.3 V at 25 °C and are for design guidance only, unless otherwise specified.

**Table 10. DC GPIO Specifications**

Symbol	Description	Min	Typ	Max	Units	Notes
R <sub>PU</sub>	Pull-up resistor	4	5.6	8	kΩ	
R <sub>PD</sub>	Pull-down resistor	4	5.6	8	kΩ	
V <sub>OH</sub>	High output level	V <sub>dd</sub> – 1.0	–	–	V	I <sub>OH</sub> = 10 mA, V <sub>dd</sub> = 4.75 to 5.25 V (8 total loads, 4 on even port pins (for example, P0[2], P1[4]), 4 on odd port pins (for example, P0[3], P1[5])). 80 mA maximum combined I <sub>OH</sub> budget
V <sub>OL</sub>	Low output level	–	–	0.75	V	I <sub>OL</sub> = 25 mA, V <sub>dd</sub> = 4.75 to 5.25 V (8 total loads, 4 on even port pins (for example, P0[2], P1[4]), 4 on odd port pins (for example, P0[3], P1[5])). 150 mA maximum combined I <sub>OL</sub> budget.
I <sub>OH</sub>	High level source current	10	–	–	mA	V <sub>OH</sub> = V <sub>dd</sub> – 1.0 V, see the limitations of the total current in the note for V <sub>OH</sub> .
I <sub>OL</sub>	Low level sink current	25	–	–	mA	V <sub>OL</sub> = 0.75 V, see the limitations of the total current in the note for V <sub>OL</sub> .
V <sub>IL</sub>	Input Low level	–	–	0.8	V	V <sub>dd</sub> = 3.0 to 5.25
V <sub>IH</sub>	Input High level	2.1	–	–	V	V <sub>dd</sub> = 3.0 to 5.25
V <sub>H</sub>	Input hysteresis	–	60	–	mV	
I <sub>IL</sub>	Input leakage (absolute value)	–	1	–	nA	Gross tested to 1 μA
C <sub>IN</sub>	Capacitive load on pins as input	–	3.5	10	pF	Package and pin dependent. Temp = 25 °C
C <sub>OUT</sub>	Capacitive load on pins as output	–	3.5	10	pF	Package and pin dependent. Temp = 25 °C



*DC Operational Amplifier Specifications*

The following tables list the guaranteed maximum and minimum specifications for the voltage and temperature ranges: 4.75 V to 5.25 V and  $-40\text{ }^{\circ}\text{C} \leq T_A \leq 85\text{ }^{\circ}\text{C}$ , 3.0 V to 3.6 V and  $-40\text{ }^{\circ}\text{C} \leq T_A \leq 85\text{ }^{\circ}\text{C}$  respectively. Typical parameters apply to 5 V or 3.3 V at 25 °C and are for design guidance only.

**Table 11. 5 V DC Operational Amplifier Specifications**

Symbol	Description	Min	Typ	Max	Units	Notes
$V_{OSOA}$	Input offset voltage (absolute value)	–	2.5	15	mV	
$TCV_{OSOA}$	Average input offset voltage drift	–	10	–	$\mu\text{V}/^{\circ}\text{C}$	
$I_{EBOA}^{[6]}$	Input leakage current (Port 0 Analog Pins)	–	200	–	pA	Gross tested to 1 $\mu\text{A}$
$C_{INOA}$	Input capacitance (Port 0 Analog Pins)	–	4.5	9.5	pF	Package and pin dependent. Temp = 25 °C
$V_{CMOA}$	Common mode Voltage Range	0.0	–	Vdd - 1	V	

**Table 12. 3.3 V DC Operational Amplifier Specifications**

Symbol	Description	Min	Typ	Max	Units	Notes
$V_{OSOA}$	Input offset voltage (absolute value)	–	2.5	15	mV	
$TCV_{OSOA}$	Average input offset voltage drift	–	10	–	$\mu\text{V}/^{\circ}\text{C}$	
$I_{EBOA}^{[6]}$	Input leakage current (Port 0 Analog Pins)	–	200	–	pA	Gross tested to 1 $\mu\text{A}$
$C_{INOA}$	Input capacitance (Port 0 Analog Pins)	–	4.5	9.5	pF	Package and pin dependent. Temp = 25 °C
$V_{CMOA}$	Common mode voltage range	0	–	Vdd - 1	V	

**Note**

6. Atypical behavior:  $I_{EBOA}$  of Port 0 Pin 0 is below 1 nA at 25 °C; 50 nA over temperature. Use Port 0 Pins 1-7 for the lowest leakage of 200 nA.

*DC Low Power Comparator Specifications*

Table 13 lists the guaranteed maximum and minimum specifications for the voltage and temperature ranges: 4.75 V to 5.25 V and  $-40\text{ }^{\circ}\text{C} \leq T_A \leq 85\text{ }^{\circ}\text{C}$ , 3.0 V to 3.6 V and  $-40\text{ }^{\circ}\text{C} \leq T_A \leq 85\text{ }^{\circ}\text{C}$  respectively. Typical parameters apply to 5 V at 25 °C and are for design guidance only.

**Table 13. DC Low Power Comparator Specifications**

Symbol	Description	Min	Typ	Max	Units	Notes
$V_{REFLPC}$	Low power comparator (LPC) reference voltage range	0.2	–	$V_{DD} - 1$	V	
$V_{OSLPC}$	LPC voltage offset	–	2.5	30	mV	

*SAR10 ADC DC Specifications*

Table 14 lists the guaranteed maximum and minimum specifications for the voltage and temperature ranges: 4.75 V to 5.25 V and  $-40\text{ }^{\circ}\text{C} \leq T_A \leq 85\text{ }^{\circ}\text{C}$ , or 3.0 V to 3.6 V and  $-40\text{ }^{\circ}\text{C} \leq T_A \leq 85\text{ }^{\circ}\text{C}$ , respectively. Typical parameters apply to 5 V or 3.3 V at 25 °C and are for design guidance only.

**Table 14. SAR10 ADC DC Specifications**

Symbol	Description	Min	Typ	Max	Units	Notes
$V_{adcvref}$	Reference voltage at pin P2[5] when configured as ADC reference voltage	3.0	–	5.25	V	When $V_{REF}$ is buffered inside ADC, the voltage level at P2[5] (when configured as ADC reference voltage) must be always maintained to be at least 300 mV less than the chip supply voltage level on Vdd pin. ( $V_{adcvref} < V_{DD}$ )
$I_{adcvref}$	Current when P2[5] is configured as ADC $V_{REF}$	–	–	0.5	mA	Disables the internal voltage reference buffer
INL at 10 bits	Integral Nonlinearity	–2.5	–	2.5	LSB	For $V_{DD} \geq 3.0\text{ V}$ and $V_{ref} \geq 3.0\text{ V}$
		–5.0	–	5.0	LSB	For $V_{DD} < 3.0\text{ V}$ or $V_{ref} < 3.0\text{ V}$
DNL at 10 bits	Differential Nonlinearity	–1.5	–	1.5	LSB	For $V_{DD} \geq 3.0\text{ V}$ and $V_{ref} \geq 3.0\text{ V}$
		–4.0	–	4.0	LSB	For $V_{DD} < 3.0\text{ V}$ or $V_{ref} < 3.0\text{ V}$
SPS	Sample per second	–	–	150	ksps	Resolution 10 bits

*DC Analog Mux Bus Specifications*

Table 15 lists the guaranteed maximum and minimum specifications for the voltage and temperature ranges: 4.75 V to 5.25 V and  $-40\text{ }^{\circ}\text{C} \leq T_A \leq 85\text{ }^{\circ}\text{C}$  or 3.0 V to 3.6 V and  $-40\text{ }^{\circ}\text{C} \leq T_A \leq 85\text{ }^{\circ}\text{C}$ , respectively. Typical parameters apply to 5 V or 3.3 V at 25 °C and are for design guidance only.

**Table 15. DC Analog Mux Bus Specifications**

Symbol	Description	Min	Typ	Max	Units	Notes
R <sub>SW</sub>	Switch Resistance to Common Analog Bus	–	–	400	Ω	V <sub>dd</sub> ≥ 3.00
R <sub>gnd</sub>	Resistance of Initialization Switch to gnd	–	–	800	Ω	

*DC POR and LVD Specifications*

Table 16 lists the guaranteed maximum and minimum specifications for the voltage and temperature ranges: 4.75 V to 5.25 V and  $-40\text{ }^{\circ}\text{C} \leq T_A \leq 85\text{ }^{\circ}\text{C}$  or 3.0 V to 3.6 V and  $-40\text{ }^{\circ}\text{C} \leq T_A \leq 85\text{ }^{\circ}\text{C}$ , respectively. Typical parameters apply to 5 V or 3.3 V at 25 °C and are for design guidance only.

**Table 16. DC POR and LVD Specifications**

Symbol	Description	Min	Typ	Max	Units	Notes
V <sub>PPOR1</sub> V <sub>PPOR2</sub>	V <sub>dd</sub> Value for PPOR Trip PORLEV[1:0] = 01b PORLEV[1:0] = 10b	–	2.82 4.55	2.95 4.70	V V	V <sub>dd</sub> must be greater than or equal to 3.0 V during startup, reset from the XRES pin, or reset from Watchdog.
V <sub>LVD2</sub> V <sub>LVD3</sub> V <sub>LVD4</sub> V <sub>LVD5</sub> V <sub>LVD6</sub> V <sub>LVD7</sub>	V <sub>dd</sub> Value for LVD Trip VM[2:0] = 010b VM[2:0] = 011b VM[2:0] = 100b VM[2:0] = 101b VM[2:0] = 110b VM[2:0] = 111b	2.95 3.06 4.37 4.50 4.62 4.71	3.02 3.13 4.48 4.64 4.73 4.81	3.09 3.20 4.55 4.75 4.83 4.95	V V V V V V	

### DC Programming Specifications

Table 17 lists the guaranteed maximum and minimum specifications for the voltage and temperature ranges: 4.75 V to 5.25 V and  $-40\text{ }^{\circ}\text{C} \leq T_A \leq 85\text{ }^{\circ}\text{C}$  or 3.0 V to 3.6 V and  $-40\text{ }^{\circ}\text{C} \leq T_A \leq 85\text{ }^{\circ}\text{C}$ , respectively. Typical parameters apply to 5 V or 3.3 V at 25 °C and are for design guidance only.

**Table 17. DC Programming Specifications**

Symbol	Description	Min	Typ	Max	Units	Notes
V <sub>DDP</sub>	V <sub>DD</sub> for programming and erase	4.5	5.0	5.5	V	This specification applies to the functional requirements of external programmer tools
V <sub>DDL</sub>	Low V <sub>DD</sub> for verify	3.0	3.1	3.2	V	This specification applies to the functional requirements of external programmer tools
V <sub>DDHV</sub>	High V <sub>DD</sub> for verify	5.1	5.2	5.3	V	This specification applies to the functional requirements of external programmer tools
V <sub>DDIWRITE</sub>	Supply voltage for flash write operation	3.0	–	5.25	V	This specification applies to this device when it is executing internal flash writes
I <sub>DDP</sub>	Supply Current during Programming or Verify	–	5	25	mA	
V <sub>ILP</sub>	Input Low Voltage during Programming or Verify	–	–	0.8	V	
V <sub>IHP</sub>	Input High Voltage during Programming or Verify	2.2	–	–	V	
I <sub>ILP</sub>	Input Current when Applying V <sub>ILP</sub> to P1[0] or P1[1] during Programming or Verify	–	–	0.2	mA	Driving internal pull down resistor
I <sub>IHP</sub>	Input Current when Applying V <sub>IHP</sub> to P1[0] or P1[1] during Programming or Verify	–	–	1.5	mA	Driving internal pull down resistor
V <sub>OLV</sub>	Output Low Voltage during Programming or Verify	–	–	V <sub>ss</sub> + 0.75	V	
V <sub>OHV</sub>	Output High Voltage during Programming or Verify	V <sub>dd</sub> - 1.0	–	V <sub>dd</sub>	V	
Flash <sub>ENPB</sub>	Flash Endurance (per block) <sup>[8]</sup>	50,000	–	–	–	Erase/write cycles per block
Flash <sub>ENT</sub>	Flash Endurance (total) <sup>[7]</sup>	1,800,000	–	–	–	Erase/write cycles
Flash <sub>DR</sub>	Flash Data Retention	10	–	–	Years	

### DC I<sup>2</sup>C Specifications

Table 18 lists the guaranteed maximum and minimum specifications for the voltage and temperature ranges: 4.75 V to 5.25 V and  $-40\text{ }^{\circ}\text{C} \leq T_A \leq 85\text{ }^{\circ}\text{C}$  or 3.0 V to 3.6 V and  $-40\text{ }^{\circ}\text{C} \leq T_A \leq 85\text{ }^{\circ}\text{C}$ , respectively. Typical parameters apply to 5 V or 3.3 V at 25 °C and are for design guidance only.

**Table 18. DC I<sup>2</sup>C Specifications**

Parameter	Description	Min	Typ	Max	Units	Notes
V <sub>IL12C</sub> <sup>[9]</sup>	Input low level	–	–	0.3 × V <sub>DD</sub>	V	3.0 V ≤ V <sub>DD</sub> ≤ 3.6 V
		–	–	0.25 × V <sub>DD</sub>	V	4.75 V ≤ V <sub>DD</sub> ≤ 5.25 V
V <sub>IH12C</sub> <sup>[9]</sup>	Input high level	0.7 × V <sub>DD</sub>	–	–	V	3.0 V ≤ V <sub>DD</sub> ≤ 5.25 V

**Note**

- A maximum of 36 x 50,000 block endurance cycles is allowed. This may be balanced between operations on 36x1 blocks of 50,000 maximum cycles each, 36x2 blocks of 25,000 maximum cycles each, or 36x4 blocks of 12,500 maximum cycles each (to limit the total number of cycles to 36x50,000 and that no single block ever sees more than 50,000 cycles).  
For the full industrial range, the user must employ a temperature sensor user module (FlashTemp) and feed the result to the temperature argument before writing. Refer to the Flash APIs Application Note AN2015 at <http://www.cypress.com> under Application Notes for more information.
- The 50,000 cycle Flash endurance per block is guaranteed only if the Flash operates within one voltage range. Voltage ranges are 3.0 V to 3.6 V and 4.75 V to 5.25 V
- All GPIOs meet the DC GPIO V<sub>IL</sub> and V<sub>IH</sub> specifications found in the DC GPIO specifications sections. The I<sup>2</sup>C GPIO pins also meet the above specs.

## AC Electrical Characteristics

### AC Chip Level Specifications

The following tables list the guaranteed maximum and minimum specifications for the voltage and temperature ranges: 4.75 V to 5.25 V and  $-40\text{ }^{\circ}\text{C} \leq T_A \leq 85\text{ }^{\circ}\text{C}$  or 3.0 V to 3.6 V and  $-40\text{ }^{\circ}\text{C} \leq T_A \leq 85\text{ }^{\circ}\text{C}$ , respectively. Typical parameters apply to 5 V or 3.3 V at 25 °C and are for design guidance only.

**Table 19. 5 V and 3.3 V AC Chip-Level Specifications**

Symbol	Description	Min	Min(%)	Typ	Max	Max(%)	Units	Notes
F <sub>IMO24</sub>	Internal Main Oscillator Frequency for 24 MHz	22.8	–	24	25.2 <sup>[10,11,12]</sup>	–	MHz	Trimmed for 5 V or 3.3 V operation using factory trim values. See <a href="#">Figure 5 on page 13</a> . SLIMO mode = 0 < 85
F <sub>IMO6</sub>	Internal Main Oscillator Frequency for 6 MHz	5.5	8	6	6.5 <sup>[10,11,12]</sup>	8	MHz	Trimmed for 5 V or 3.3 V operation using factory trim values. See <a href="#">Figure 5 on page 13</a> . SLIMO mode = 0 < 85.
F <sub>CPU1</sub>	CPU Frequency (5 V Nominal)	0.089	–	24	24.6 <sup>[10,11]</sup>	–	MHz	24 MHz only for SLIMO mode = 0.
F <sub>CPU2</sub>	CPU Frequency (3.3 V Nominal)	0.089	–	12	12.3 <sup>[11,12]</sup>	–	MHz	SLIMO mode = 0.
F <sub>BLK5</sub>	Digital PSoC Block Frequency (5 V Nominal)	0	–	48	49.2 <sup>[10,11,13]</sup>	–	MHz	Refer to <a href="#">Table 23 on page 23</a> .
F <sub>BLK33</sub>	Digital PSoC Block Frequency (3.3 V Nominal)	0	–	24	24.6 <sup>[11,13]</sup>	–	MHz	
F <sub>32K1</sub>	Internal Low Speed Oscillator Frequency	15	–	32	85	–	kHz	
F <sub>32KU</sub>	Untrimmed Internal Low Speed Oscillator Frequency	5	–	–	100	–	kHz	The ILO is not adjusted with the factory trim values until after the CPU starts running. See the “System Resets” section in the Technical Reference Manual.
T <sub>XRST</sub>	External Reset Pulse Width	10	–	–	–	–	μs	
DC <sub>24M</sub>	24 MHz Duty Cycle	40	–	50	60	–	%	
DC <sub>ILO</sub>	Internal Low Speed Oscillator Duty Cycle	20	–	50	80	–	%	
F <sub>OUT48M</sub>	48 MHz Output Frequency	46.8	–	48.0	49.2	–	MHz	Trimmed. Utilizing factory trim values.
F <sub>MAX</sub>	Maximum frequency of signal on row input or row output	–	–	–	12.3	–	MHz	
SR <sub>POWERUP</sub>	Power supply slew rate	–	–	–	250	–	V/ms	V <sub>dd</sub> slew rate during power up.
T <sub>POWERUP</sub>	Time from end of POR to CPU executing code	–	–	–	100	–	ms	
tjit_IMO <sup>[14]</sup>	24 MHz IMO cycle-to-cycle jitter (RMS)	–	–	200	700	–	ps	
	24 MHz IMO long term N cycle-to-cycle jitter (RMS)	–	–	300	900	–	ps	N = 32
	24 MHz IMO period jitter (RMS)	–	–	100	400	–	ps	
tjit_PLL <sup>[14]</sup>	24 MHz IMO cycle-to-cycle jitter (RMS)	–	–	200	800	–	ps	
	24 MHz IMO long term N cycle-to-cycle jitter (RMS)	–	–	300	1200	–	ps	N = 32
	24 MHz IMO period jitter (RMS)	–	–	100	700	–	ps	

#### Notes

10. Valid only for 4.75 V < V<sub>dd</sub> < 5.25 V.
11. Accuracy derived from Internal Main Oscillator with appropriate trim for V<sub>dd</sub> range.
12. 3.0 V < V<sub>dd</sub> < 3.6 V.
13. Refer to the individual user module data sheets for information on maximum frequencies for user modules.
14. Refer to Cypress Jitter Specifications, [Understanding Datasheet Jitter Specifications for Cypress Timing Products](#) for more information.

**AC GPIO Specifications**

Table 20 lists the guaranteed maximum and minimum specifications for the voltage and temperature ranges: 4.75 V to 5.25 V and  $-40\text{ }^{\circ}\text{C} \leq T_A \leq 85\text{ }^{\circ}\text{C}$  or 3.0 V to 3.6 V and  $-40\text{ }^{\circ}\text{C} \leq T_A \leq 85\text{ }^{\circ}\text{C}$ , respectively. Typical parameters apply to 5 V or 3.3 V at 25 °C and are for design guidance only.

**Table 20. 5 V and 3.3 V AC GPIO Specifications**

Symbol	Description	Min	Typ	Max	Units	Notes
$F_{GPIO}$	GPIO operating frequency	0	–	12	MHz	Normal Strong Mode
$T_{RiseF}$	Rise time, normal strong mode, $C_{load} = 50\text{ pF}$	3	–	18	ns	$V_{dd} = 4.5\text{ to }5.25\text{ V}$ , 10% to 90%
$T_{FallF}$	Fall time, normal strong mode, $C_{load} = 50\text{ pF}$	2	–	18	ns	$V_{dd} = 4.5\text{ to }5.25\text{ V}$ , 10% to 90%
$T_{RiseS}$	Rise time, slow strong mode, $C_{load} = 50\text{ pF}$	7	27	–	ns	$V_{dd} = 3\text{ to }5.25\text{ V}$ , 10% to 90%
$T_{FallS}$	Fall time, slow strong mode, $C_{load} = 50\text{ pF}$	7	22	–	ns	$V_{dd} = 3\text{ to }5.25\text{ V}$ , 10% to 90%

**Figure 6. GPIO Timing Diagram**

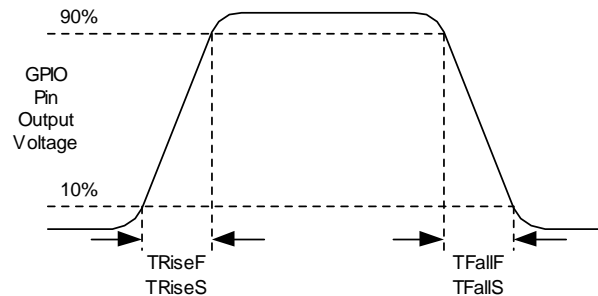

**AC Operational Amplifier Specifications**

Table 21 lists the guaranteed maximum and minimum specifications for the voltage and temperature ranges: 4.75 V to 5.25 V and  $-40\text{ }^{\circ}\text{C} \leq T_A \leq 85\text{ }^{\circ}\text{C}$  or 3.0 V to 3.6 V and  $-40\text{ }^{\circ}\text{C} \leq T_A \leq 85\text{ }^{\circ}\text{C}$ , respectively. Typical parameters apply to 5 V or 3.3 V at 25 °C and are for design guidance only.

**Table 21. AC Operational Amplifier Specifications**

Symbol	Description	Min	Typ	Max	Units	Notes
$T_{COMP}$	Comparator Mode Response Time, 50 mV			100	ns	$V_{dd} \geq 3.0\text{ V}$

**AC Low Power Comparator Specifications**

Table 22 lists the guaranteed maximum and minimum specifications for the voltage and temperature ranges: 4.75 V to 5.25 V and  $-40\text{ }^{\circ}\text{C} \leq T_A \leq 85\text{ }^{\circ}\text{C}$  or 3.0 V to 3.6 V and  $-40\text{ }^{\circ}\text{C} \leq T_A \leq 85\text{ }^{\circ}\text{C}$ , respectively. Typical parameters apply to 5 V at 25 °C and are for design guidance only.

**Table 22. AC Low Power Comparator Specifications**

Symbol	Description	Min	Typ	Max	Units	Notes
$T_{RLPC}$	LPC response time	–	–	50	$\mu\text{s}$	$\geq 50\text{ mV}$ overdrive comparator reference set within $V_{REFLPC}$

*AC Digital Block Specifications*

The following tables list the guaranteed maximum and minimum specifications for the voltage and temperature ranges: 4.75 V to 5.25 V and  $-40\text{ }^{\circ}\text{C} \leq T_A \leq 85\text{ }^{\circ}\text{C}$  or 3.0 V to 3.6 V and  $-40\text{ }^{\circ}\text{C} \leq T_A \leq 85\text{ }^{\circ}\text{C}$ , respectively. Typical parameters apply to 5 V or 3.3 V, at 25 °C and are for design guidance only.

**Table 23. AC Digital Block Specifications**

Function	Description	Min	Typ	Max	Units	Notes
All functions	Block Input Clock Frequency					
	Vdd ≥ 4.75 V	–	–	50.4 <sup>[15]</sup>	MHz	
	Vdd < 4.75 V	–	–	25.2 <sup>[15]</sup>	MHz	
Timer	Input Clock Frequency					
	No Capture, Vdd ≥ 4.75 V	–	–	50.4 <sup>[15]</sup>	MHz	
	No Capture, Vdd < 4.75 V	–	–	25.2 <sup>[15]</sup>	MHz	
	With Capture	–	–	25.2 <sup>[15]</sup>	MHz	
	Capture Pulse Width	50 <sup>[16]</sup>	–	–	ns	
Counter	Input Clock Frequency					
	No Enable Input, Vdd ≥ 4.75 V	–	–	50.4 <sup>[15]</sup>	MHz	
	No Enable Input, Vdd < 4.75 V	–	–	25.2 <sup>[15]</sup>	MHz	
	With Enable Input	–	–	25.2 <sup>[15]</sup>	MHz	
	Enable Input Pulse Width	50 <sup>[16]</sup>	–	–	ns	
Dead Band	Kill Pulse Width					
	Asynchronous Restart Mode	20	–	–	ns	
	Synchronous Restart Mode	50 <sup>[16]</sup>	–	–	ns	
	Disable Mode	50 <sup>[16]</sup>	–	–	ns	
	Input Clock Frequency					
	Vdd ≥ 4.75 V	–	–	50.4 <sup>[15]</sup>	MHz	
Vdd < 4.75 V	–	–	25.2 <sup>[15]</sup>	MHz		
CRCPRS (PRS Mode)	Input Clock Frequency					
	Vdd ≥ 4.75 V	–	–	50.4 <sup>[15]</sup>	MHz	
	Vdd < 4.75 V	–	–	25.2 <sup>[15]</sup>	MHz	
CRCPRS (CRC Mode)	Input Clock Frequency	–	–	25.2 <sup>[15]</sup>	MHz	
SPIM	Input Clock Frequency	–	–	8.4 <sup>[15]</sup>	MHz	The SPI serial clock (SCLK) frequency is equal to the input clock frequency divided by 2.
SPIS	Input Clock (SCLK) Frequency	–	–	4.2 <sup>[15]</sup>	MHz	The input clock is the SPI SCLK in SPIS mode.
	Width of SS_Negated Between Transmissions	50 <sup>[16]</sup>	–	–	ns	
Transmitter	Input Clock Frequency					The baud rate is equal to the input clock frequency divided by 8.
	Vdd ≥ 4.75 V, 2 Stop Bits	–	–	50.4 <sup>[15]</sup>	MHz	
	Vdd ≥ 4.75 V, 1 Stop Bit	–	–	25.2 <sup>[15]</sup>	MHz	
	Vdd < 4.75 V	–	–	25.2 <sup>[15]</sup>	MHz	
Receiver	Input Clock Frequency					The baud rate is equal to the input clock frequency divided by 8.
	Vdd ≥ 4.75 V, 2 Stop Bits	–	–	50.4 <sup>[15]</sup>	MHz	
	Vdd ≥ 4.75 V, 1 Stop Bit	–	–	25.2 <sup>[15]</sup>	MHz	
	Vdd < 4.75 V	–	–	25.2 <sup>[15]</sup>	MHz	

**Notes**

- 15. Accuracy derived from IMO with appropriate trim for V<sub>DD</sub> range.
- 16. 50 ns minimum input pulse width is based on the input synchronizers running at 24 MHz (42 ns nominal period).

*AC External Clock Specifications*

The following tables list the guaranteed maximum and minimum specifications for the voltage and temperature ranges: 4.75 V to 5.25 V and  $-40\text{ }^{\circ}\text{C} \leq T_A \leq 85\text{ }^{\circ}\text{C}$ , or 3.0 V to 3.6 V and  $-40\text{ }^{\circ}\text{C} \leq T_A \leq 85\text{ }^{\circ}\text{C}$ , respectively. Typical parameters apply to 5 V or 3.3 V at 25 °C and are for design guidance only.

**Table 24. 5 V AC External Clock Specifications**

Symbol	Description	Min	Typ	Max	Units	Notes
F <sub>OSCEXT</sub>	Frequency	0.093	–	24.6	MHz	
–	High Period	20.6	–	5300	ns	
–	Low Period	20.6	–	–	ns	
–	Power Up IMO to Switch	150	–	–	μs	

**Table 25. 3.3 V AC External Clock Specifications**

Symbol	Description	Min	Typ	Max	Units	Notes
F <sub>OSCEXT</sub>	Frequency with CPU Clock divide by 1	0.093	–	12.3	MHz	Maximum CPU frequency is 12 MHz at 3.3 V. With the CPU clock divider set to 1, the external clock must adhere to the maximum frequency and duty cycle requirements.
F <sub>OSCEXT</sub>	Frequency with CPU Clock divide by 2 or greater	0.186	–	24.6	MHz	If the frequency of the external clock is greater than 12 MHz, the CPU clock divider must be set to 2 or greater. In this case, the CPU clock divider ensures that the fifty percent duty cycle requirement is met.
–	High Period with CPU Clock divide by 1	41.7	–	5300	ns	
–	Low Period with CPU Clock divide by 1	41.7	–	–	ns	
–	Power Up IMO to Switch	150	–	–	μs	

*SAR10 ADC AC Specifications*

Table 26 lists the guaranteed maximum and minimum specifications for the voltage and temperature ranges: 4.75 V to 5.25 V and  $-40\text{ }^{\circ}\text{C} \leq T_A \leq 85\text{ }^{\circ}\text{C}$ , or 3.0 V to 3.6 V and  $-40\text{ }^{\circ}\text{C} \leq T_A \leq 85\text{ }^{\circ}\text{C}$ , respectively. Typical parameters apply to 5 V and 3.3 V at 25 °C and are for design guidance only.

**Table 26. SAR10 ADC AC Specifications**

Symbol	Description	Min	Typ	Max	Units	Notes
Freq <sub>3</sub>	Input clock frequency 3 V	–	–	2.7	MHz	
Freq <sub>5</sub>	Input clock frequency 5 V	–	–	2.7	MHz	



### AC Programming Specifications

Table 27 lists the guaranteed maximum and minimum specifications for the voltage and temperature ranges: 4.75 V to 5.25 V and  $-40\text{ }^{\circ}\text{C} \leq T_A \leq 85\text{ }^{\circ}\text{C}$ , or 3.0 V to 3.6 V and  $-40\text{ }^{\circ}\text{C} \leq T_A \leq 85\text{ }^{\circ}\text{C}$ , respectively. Typical parameters apply to 5 V, or 3.3 V at 25 °C and are for design guidance only.

**Table 27. AC Programming Specifications**

Symbol	Description	Min	Typ	Max	Units	Notes
$T_{RSCLK}$	Rise Time of SCLK	1	–	20	ns	
$T_{FSCLK}$	Fall Time of SCLK	1	–	20	ns	
$T_{SSCLK}$	Data Set up Time to Falling Edge of SCLK	40	–	–	ns	
$T_{HSCLK}$	Data Hold Time from Falling Edge of SCLK	40	–	–	ns	
$F_{SCLK}$	Frequency of SCLK	0	–	8	MHz	
$F_{SCLK3}$	Frequency of SCLK3	0	–	6	MHz	$V_{DD} < 3.6\text{ V}$
$T_{ERASEB}$	Flash Erase Time (Block)	–	10	–	ms	
$T_{WRITE}$	Flash Block Write Time	–	40	–	ms	
$T_{DSCLK}$	Data Out Delay from Falling Edge of SCLK	–	–	55	ns	$3.6 < V_{DD}$ ; at 30 pF Load
$T_{DSCLK3}$	Data Out Delay from Falling Edge of SCLK	–	–	65	ns	$3.0 \leq V_{DD} \leq 3.6$ ; at 30 pF Load
$T_{ERASEALL}$	Flash Erase Time (Bulk)	–	40	–	ns	
$T_{PROGRAM\_HOT}$	Flash Block Erase + Flash Block Write Time	–	–	100	ms	
$T_{PROGRAM\_COLD}$	Flash Block Erase + Flash Block Write Time	–	–	200	ms	

AC I<sup>2</sup>C Specifications

Table 28 lists the guaranteed maximum and minimum specifications for the voltage and temperature ranges: 4.75 V to 5.25 V and  $-40\text{ }^{\circ}\text{C} \leq T_A \leq 85\text{ }^{\circ}\text{C}$ , and 3.0 V to 3.6 V and  $-40\text{ }^{\circ}\text{C} \leq T_A \leq 85\text{ }^{\circ}\text{C}$ , respectively. Typical parameters apply to 5 V, 3.3 V, or 2.7 V at 25 °C and are for design guidance only.

Table 28. AC Characteristics of the I<sup>2</sup>C SDA and SCL Pins for V<sub>dd</sub> ≥ 3.0 V

Symbol	Description	Standard Mode		Fast Mode		Units	Notes
		Min	Max	Min	Max		
F <sub>SCL I2C</sub>	SCL Clock Frequency	0	100	0	400	kHz	
T <sub>HDSTAI2C</sub>	Hold Time (repeated) START Condition. After this period, the first clock pulse is generated.	4.0	–	0.6	–	μs	
T <sub>LOWI2C</sub>	LOW Period of the SCL Clock	4.7	–	1.3	–	μs	
T <sub>HIGHI2C</sub>	HIGH Period of the SCL Clock	4.0	–	0.6	–	μs	
T <sub>SUSTA I2C</sub>	Setup Time for a Repeated START Condition	4.7	–	0.6	–	μs	
T <sub>HDDAT I2C</sub>	Data Hold Time	0	–	0	–	μs	
T <sub>SUDAT I2C</sub>	Data Setup Time	250	–	100 <sup>[17]</sup>	–	ns	
T <sub>SUSTOI2C</sub>	Setup Time for STOP Condition	4.0	–	0.6	–	μs	
T <sub>BUFI2C</sub>	Bus Free Time Between a STOP and START Condition	4.7	–	1.3	–	μs	
T <sub>SP I2C</sub>	Pulse Width of spikes are suppressed by the Input Filter	–	–	0	50	ns	

Figure 7. Definition for Timing for Fast/Standard Mode on the I<sup>2</sup>C Bus

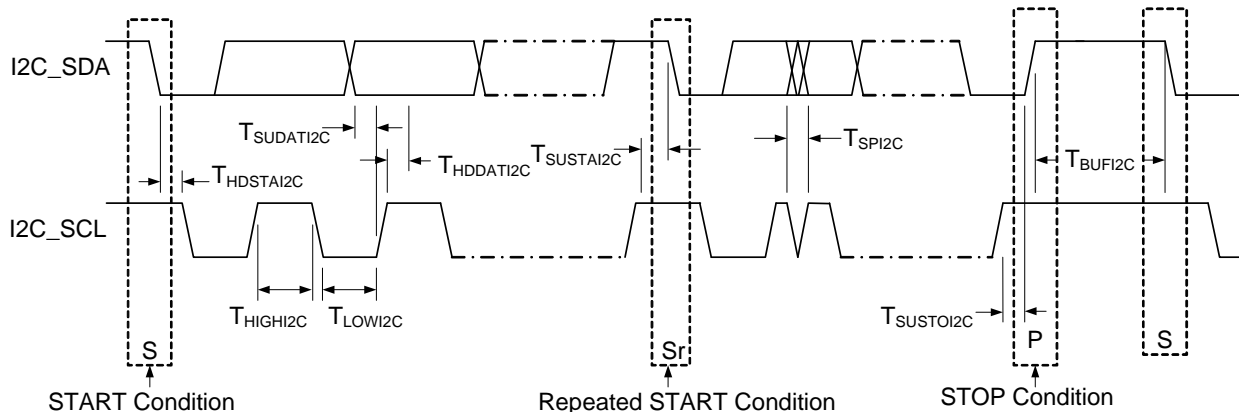

Note

17. A Fast-Mode I2C-bus device may be used in a Standard-Mode I2C-bus system, but the requirement  $T_{SUDAT I2C} \geq 250\text{ ns}$  must then be met. This is automatically the case if the device does not stretch the LOW period of the SCL signal. If such device does stretch the LOW period of the SCL signal, it must output the next data bit to the SDA line  $t_{\text{max}} + T_{SUDAT I2C} = 1000 + 250 = 1250\text{ ns}$  (according to the Standard-Mode I2C-bus specification) before the SCL line is released.

**Packaging Information**

**Figure 8. 28-pin SOIC**

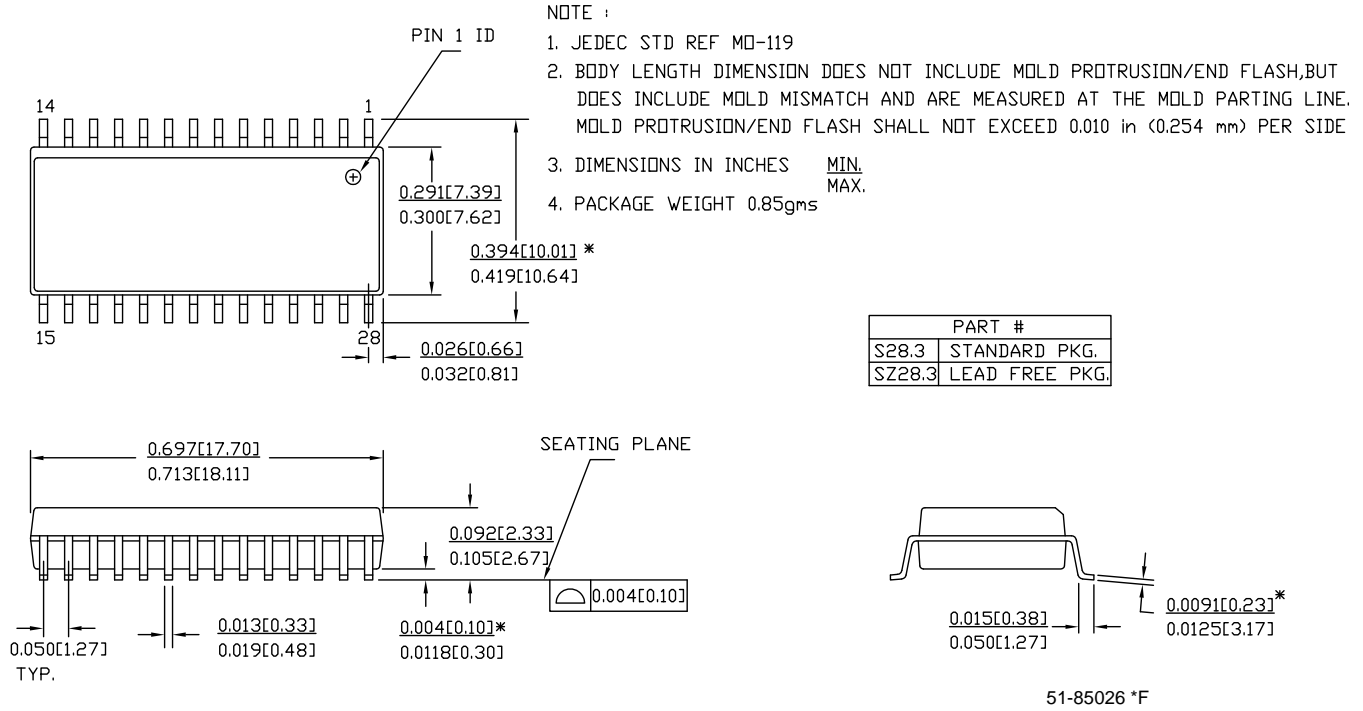

**Figure 9. 44-pin TQFP**

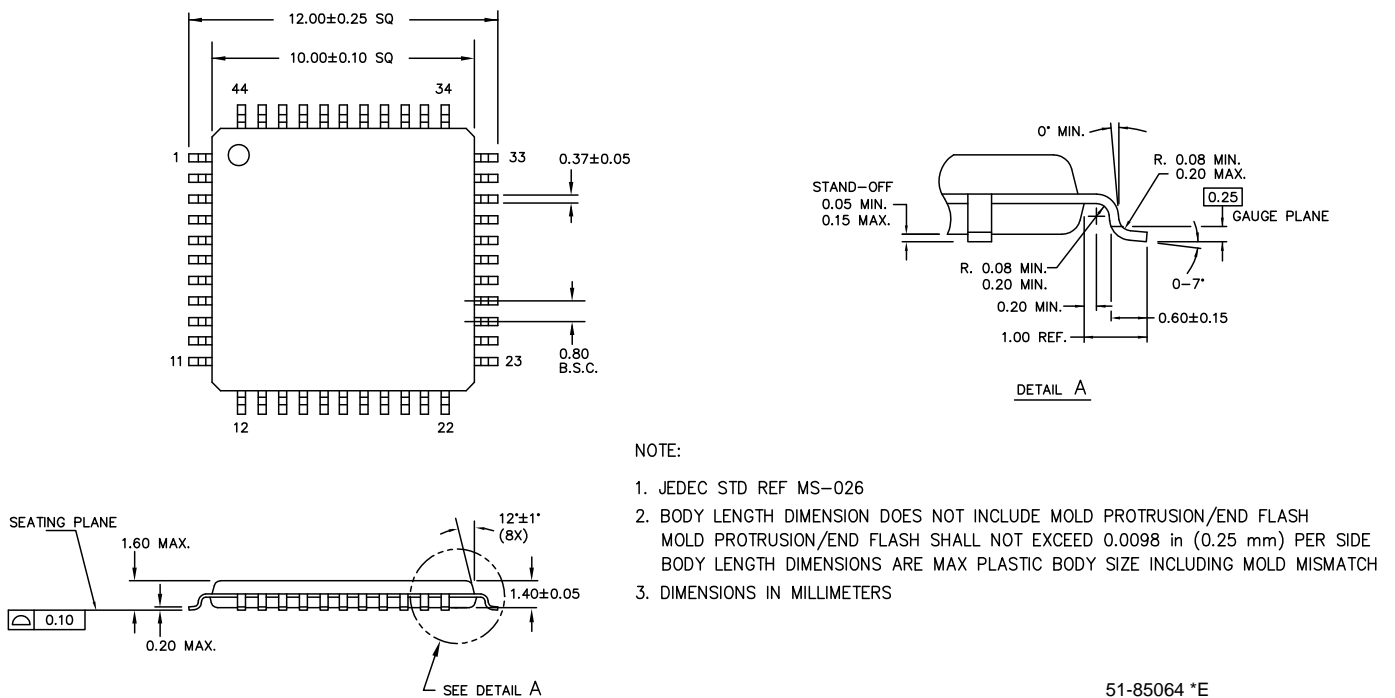

## Thermal Impedances

**Table 29. Thermal Impedances per Package**

Package	Typical $\theta_{JA}$ [19]
28-pin SOIC	68 °C/W
44-pin TQFP	61 °C/W

## Solder Reflow Specifications

Table 30 shows the solder reflow temperature limits that must not be exceeded.

**Table 30. Solder Reflow Specifications**

Package	Maximum Peak Temperature (T <sub>C</sub> )	Maximum Time above T <sub>C</sub> – 5 °C
28-pin SOIC	260 °C	30 seconds
44-pin TQFP	260 °C	30 seconds

## Ordering Information

The following table lists the key package features and ordering codes of this PSoC device family.

**Table 31. PSoC Device Family Key Features and Ordering Information**

Package	Ordering Code	Flash (Kbytes)	RAM (Bytes)	Temperature Range	Digital Blocks (Rows of 4)	Analog Blocks (Columns of 3)	Digital I/O Pins	Analog Inputs	Analog Outputs	XRES Pin
28-pin SOIC	CY8C21345-24SXI	8	512B	–40 °C to +85 °C	4	6	24	24 <sup>[18]</sup>	0	Y
28-pin SOIC (Tape and Reel)	CY8C21345-24SXIT	8	512B	–40 °C to +85 °C	4	6	24	24 <sup>[18]</sup>	0	Y
28-pin SOIC	CY8C22345-24SXI	16	1K	–40 °C to +85 °C	8	6	24	24 <sup>[18]</sup>	0	Y
28-pin SOIC (Tape and Reel)	CY8C22345-24SXIT	16	1K	–40 °C to +85 °C	8	6	24	24 <sup>[18]</sup>	0	Y
44-pin TQFP	CY8C22545-24AXI	16	1K	–40 °C to +85 °C	8	6	38	38 <sup>[18]</sup>	0	Y
44-pin TQFP (Tape and Reel)	CY8C22545-24AXIT	16	1K	–40 °C to +85 °C	8	6	38	38 <sup>[18]</sup>	0	Y

## Ordering Code Definitions

CY 8 C 2x xxx-SPxx

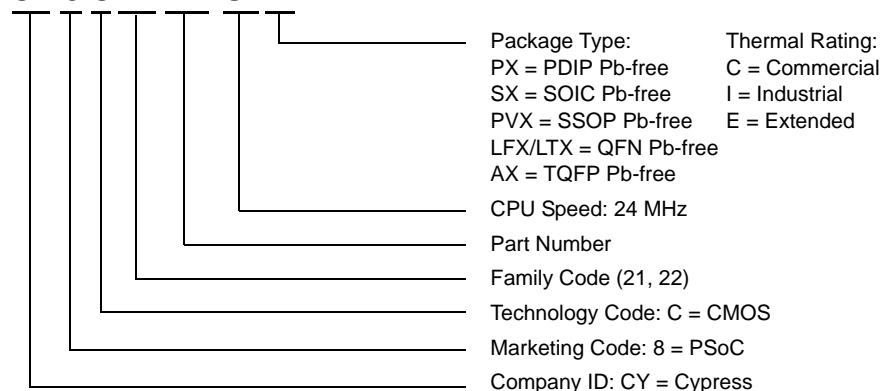

### Note

18. Ten direct inputs.

19.  $T_J = T_A + \text{POWER} \times \theta_{JA}$

## Acronyms

Table 32 lists the acronyms that are used in this document.

**Table 32. Acronyms Used in this Datasheet**

Acronym	Description	Acronym	Description
AC	alternating current	MAC	multiply-accumulate
ADC	analog-to-digital converter	MCU	microcontroller unit
API	application programming interface	MIPS	million instructions per second
CMOS	complementary metal oxide semiconductor	PCB	printed circuit board
CPU	central processing unit	PGA	programmable gain amplifier
CRC	cyclic redundancy check	PLL	phase-locked loop
CSD	CapSense sigma delta	POR	power on reset
CT	continuous time	PPOR	precision power on reset
DAC	digital-to-analog converter	PRS	pseudo-random sequence
DC	direct current	PSoC®	Programmable System-on-Chip
DNL	differential nonlinearity	PWM	pulse width modulator
ECO	external crystal oscillator	QFN	quad flat no leads
EEPROM	electrically erasable programmable read-only memory	RTC	real time clock
FSK	frequency-shift keying	SAR	successive approximation
GPIO	general-purpose I/O	SC	switched capacitor
I/O	input/output	SLIMO	slow IMO
ICE	in-circuit emulator	SOIC	small-outline integrated circuit
IDE	integrated development environment	SPI™	serial peripheral interface
IDAC	current DAC	SRAM	static random access memory
ILO	internal low speed oscillator	SROM	supervisory read only memory
IMO	internal main oscillator	SSOP	shrink small-outline package
INL	integral nonlinearity	TQFP	thin quad flat pack
IrDA	infrared data association	UART	universal asynchronous receiver / transmitter
ISSP	in-system serial programming	USB	universal serial bus
LPC	low power comparator	WDT	watchdog timer
LSB	least-significant bit	XRES	external reset
LVD	low voltage detect		

## Reference Documents

CY8C22x45 and CY8C21345 PSoC® Programmable System-on-Chip™ [Technical Reference Manual \(TRM\)](#) (001-48461)

[Design Aids – Reading and Writing PSoC® Flash – AN2015](#) (001-40459)

[Understanding Datasheet Jitter Specifications for Cypress Timing Products](#)

## Document Conventions

### Units of Measure

Table 33 lists the units of measures.

**Table 33. Units of Measure**

Symbol	Unit of Measure	Symbol	Unit of Measure
kB	1024 bytes	mV	millivolts
°C	degree Celsius	nA	nanoampere
kHz	kilohertz	ns	nanosecond
kΩ	kilohm	W	ohm
LSB	least significant bit	%	percent
MHz	megahertz	pF	picofarad
μA	microampere	ps	picosecond
μs	microsecond	sps	samples per second
μV	microvolt	pA	pikoampere
mA	milliampere	V	volts
mm	millimeter	μW	microwatts
ms	millisecond	W	watt

### Numeric Conventions

Hexadecimal numbers are represented with all letters in uppercase with an appended lowercase 'h' (for example, '14h' or '3Ah'). Hexadecimal numbers may also be represented by a '0x' prefix, the C coding convention. Binary numbers have an appended lowercase 'b' (for example, '01010100b' or '01000011b'). Numbers not indicated by an 'h' or 'b' are decimals.

### Glossary

active high	<ol style="list-style-type: none"> <li>1. A logic signal having its asserted state as the logic 1 state.</li> <li>2. A logic signal having the logic 1 state as the higher voltage of the two states.</li> </ol>
analog blocks	The basic programmable opamp circuits. These are SC (switched capacitor) and CT (continuous time) blocks. These blocks can be interconnected to provide ADCs, DACs, multi-pole filters, gain stages, and much more.
analog-to-digital (ADC)	A device that changes an analog signal to a digital signal of corresponding magnitude. Typically, an ADC converts a voltage to a digital number. The digital-to-analog (DAC) converter performs the reverse operation.
API (Application Programming Interface)	A series of software routines that comprise an interface between a computer application and lower level services and functions (for example, user modules and libraries). APIs serve as building blocks for programmers that create software applications.
asynchronous	A signal whose data is acknowledged or acted upon immediately, irrespective of any clock signal.
bandgap reference	A stable voltage reference design that matches the positive temperature coefficient of $V_T$ with the negative temperature coefficient of $V_{BE}$ , to produce a zero temperature coefficient (ideally) reference.
bandwidth	<ol style="list-style-type: none"> <li>1. The frequency range of a message or information processing system measured in hertz.</li> <li>2. The width of the spectral region over which an amplifier (or absorber) has substantial gain (or loss); it is sometimes represented more specifically as, for example, full width at half maximum.</li> </ol>

## Glossary (continued)

bias	<ol style="list-style-type: none"> <li>1. A systematic deviation of a value from a reference value.</li> <li>2. The amount by which the average of a set of values departs from a reference value.</li> <li>3. The electrical, mechanical, magnetic, or other force (field) applied to a device to establish a reference level to operate the device.</li> </ol>
block	<ol style="list-style-type: none"> <li>1. A functional unit that performs a single function, such as an oscillator.</li> <li>2. A functional unit that may be configured to perform one of several functions, such as a digital PSoC block or an analog PSoC block.</li> </ol>
buffer	<ol style="list-style-type: none"> <li>1. A storage area for data that is used to compensate for a speed difference, when transferring data from one device to another. Usually refers to an area reserved for IO operations, into which data is read, or from which data is written.</li> <li>2. A portion of memory set aside to store data, often before it is sent to an external device or as it is received from an external device.</li> <li>3. An amplifier used to lower the output impedance of a system.</li> </ol>
bus	<ol style="list-style-type: none"> <li>1. A named connection of nets. Bundling nets together in a bus makes it easier to route nets with similar routing patterns.</li> <li>2. A set of signals performing a common function and carrying similar data. Typically represented using vector notation; for example, address[7:0].</li> <li>3. One or more conductors that serve as a common connection for a group of related devices.</li> </ol>
clock	The device that generates a periodic signal with a fixed frequency and duty cycle. A clock is sometimes used to synchronize different logic blocks.
comparator	An electronic circuit that produces an output voltage or current whenever two input levels simultaneously satisfy predetermined amplitude requirements.
compiler	A program that translates a high level language, such as C, into machine language.
configuration space	In PSoC devices, the register space accessed when the XIO bit, in the CPU_F register, is set to '1'.
crystal oscillator	An oscillator in which the frequency is controlled by a piezoelectric crystal. Typically a piezoelectric crystal is less sensitive to ambient temperature than other circuit components.
cyclic redundancy check (CRC)	A calculation used to detect errors in data communications, typically performed using a linear feedback shift register. Similar calculations may be used for a variety of other purposes such as data compression.
data bus	A bi-directional set of signals used by a computer to convey information from a memory location to the central processing unit and vice versa. More generally, a set of signals used to convey data between digital functions.
debugger	A hardware and software system that allows the user to analyze the operation of the system under development. A debugger usually allows the developer to step through the firmware one step at a time, set break points, and analyze memory.
dead band	A period of time when neither of two or more signals are in their active state or in transition.
digital blocks	The 8-bit logic blocks that can act as a counter, timer, serial receiver, serial transmitter, CRC generator, pseudo-random number generator, or SPI.
digital-to-analog (DAC)	A device that changes a digital signal to an analog signal of corresponding magnitude. The analog-to-digital (ADC) converter performs the reverse operation.

## Glossary (continued)

duty cycle	The relationship of a clock period high time to its low time, expressed as a percent.
emulator	Duplicates (provides an emulation of) the functions of one system with a different system, so that the second system appears to behave like the first system.
external reset (XRES)	An active high signal that is driven into the PSoC device. It causes all operation of the CPU and blocks to stop and return to a pre-defined state.
flash	An electrically programmable and erasable, non-volatile technology that provides users with the programmability and data storage of EPROMs, plus in-system erasability. Non-volatile means that the data is retained when power is off.
Flash block	The smallest amount of Flash ROM space that may be programmed at one time and the smallest amount of Flash space that may be protected. A Flash block holds 64 bytes.
frequency	The number of cycles or events per unit of time, for a periodic function.
gain	The ratio of output current, voltage, or power to input current, voltage, or power, respectively. Gain is usually expressed in dB.
I <sup>2</sup> C	A two-wire serial computer bus by Philips Semiconductors (now NXP Semiconductors). I <sup>2</sup> C is an Inter-Integrated Circuit. It is used to connect low-speed peripherals in an embedded system. The original system was created in the early 1980s as a battery control interface, but it was later used as a simple internal bus system for building control electronics. I <sup>2</sup> C uses only two bi-directional pins, clock and data, both running at +5 V and pulled high with resistors. The bus operates at 100 kbits/second in standard mode and 400 kbits/second in fast mode.
ICE	The in-circuit emulator that allows users to test the project in a hardware environment, while viewing the debugging device activity in a software environment (PSoC Designer).
input/output (I/O)	A device that introduces data into or extracts data from a system.
interrupt	A suspension of a process, such as the execution of a computer program, caused by an event external to that process, and performed in such a way that the process can be resumed.
interrupt service routine (ISR)	A block of code that normal code execution is diverted to when the M8C receives a hardware interrupt. Many interrupt sources may each exist with its own priority and individual ISR code block. Each ISR code block ends with the RETI instruction, returning the device to the point in the program where it left normal program execution.
jitter	<ol style="list-style-type: none"> <li>1. A misplacement of the timing of a transition from its ideal position. A typical form of corruption that occurs on serial data streams.</li> <li>2. The abrupt and unwanted variations of one or more signal characteristics, such as the interval between successive pulses, the amplitude of successive cycles, or the frequency or phase of successive cycles.</li> </ol>
low-voltage detect (LVD)	A circuit that senses V <sub>dd</sub> and provides an interrupt to the system when V <sub>dd</sub> falls below a selected threshold.
M8C	An 8-bit Harvard-architecture microprocessor. The microprocessor coordinates all activity inside a PSoC by interfacing to the Flash, SRAM, and register space.
master device	A device that controls the timing for data exchanges between two devices. Or when devices are cascaded in width, the master device is the one that controls the timing for data exchanges between the cascaded devices and an external interface. The controlled device is called the <b>slave device</b> .



## Glossary (continued)

microcontroller	An integrated circuit chip that is designed primarily for control systems and products. In addition to a CPU, a microcontroller typically includes memory, timing circuits, and IO circuitry. The reason for this is to permit the realization of a controller with a minimal quantity of chips, thus achieving maximal possible miniaturization. This in turn, reduces the volume and the cost of the controller. The microcontroller is normally not used for general-purpose computation as is a microprocessor.
mixed-signal	The reference to a circuit containing both analog and digital techniques and components.
modulator	A device that imposes a signal on a carrier.
noise	<ol style="list-style-type: none"><li>1. A disturbance that affects a signal and that may distort the information carried by the signal.</li><li>2. The random variations of one or more characteristics of any entity such as voltage, current, or data.</li></ol>
oscillator	A circuit that may be crystal controlled and is used to generate a clock frequency.
parity	A technique for testing transmitting data. Typically, a binary digit is added to the data to make the sum of all the digits of the binary data either always even (even parity) or always odd (odd parity).
phase-locked loop (PLL)	An electronic circuit that controls an <b>oscillator</b> so that it maintains a constant phase angle relative to a reference signal.
pinouts	The pin number assignment: the relation between the logical inputs and outputs of the PSoC device and their physical counterparts in the printed circuit board (PCB) package. Pinouts involve pin numbers as a link between schematic and PCB design (both being computer generated files) and may also involve pin names.
port	A group of pins, usually eight.
power on reset (POR)	A circuit that forces the PSoC device to reset when the voltage is below a pre-set level. This is one type of hardware reset.
PSoC®	Cypress Semiconductor's PSoC® is a registered trademark and Programmable System-on-Chip™ is a trademark of Cypress.
PSoC Designer™	The software for Cypress' Programmable System-on-Chip technology.
pulse width modulator (PWM)	An output in the form of duty cycle which varies as a function of the applied measurand
RAM	An acronym for random access memory. A data-storage device from which data can be read out and new data can be written in.
register	A storage device with a specific capacity, such as a bit or byte.
reset	A means of bringing a system back to a know state. See hardware reset and software reset.
ROM	An acronym for read only memory. A data-storage device from which data can be read out, but new data cannot be written in.
serial	<ol style="list-style-type: none"><li>1. Pertaining to a process in which all events occur one after the other.</li><li>2. Pertaining to the sequential or consecutive occurrence of two or more related activities in a single device or channel.</li></ol>
settling time	The time it takes for an output signal or value to stabilize after the input has changed from one value to another.

## Glossary (continued)

shift register	A memory storage device that sequentially shifts a word either left or right to output a stream of serial data.
slave device	A device that allows another device to control the timing for data exchanges between two devices. Or when devices are cascaded in width, the slave device is the one that allows another device to control the timing of data exchanges between the cascaded devices and an external interface. The controlling device is called the master device.
SRAM	An acronym for static random access memory. A memory device allowing users to store and retrieve data at a high rate of speed. The term static is used because, after a value has been loaded into an SRAM cell, it remains unchanged until it is explicitly altered or until power is removed from the device.
SROM	An acronym for supervisory read only memory. The SROM holds code that is used to boot the device, calibrate circuitry, and perform Flash operations. The functions of the SROM may be accessed in normal user code, operating from Flash.
stop bit	A signal following a character or block that prepares the receiving device to receive the next character or block.
synchronous	<ol style="list-style-type: none"><li>1. A signal whose data is not acknowledged or acted upon until the next active edge of a clock signal.</li><li>2. A system whose operation is synchronized by a clock signal.</li></ol>
tri-state	A function whose output can adopt three states: 0, 1, and Z (high-impedance). The function does not drive any value in the Z state and, in many respects, may be considered to be disconnected from the rest of the circuit, allowing another output to drive the same net.
UART	A UART or universal asynchronous receiver-transmitter translates between parallel bits of data and serial bits.
user modules	Pre-build, pre-tested hardware/firmware peripheral functions that take care of managing and configuring the lower level Analog and Digital PSoC Blocks. User Modules also provide high level <b>API (Application Programming Interface)</b> for the peripheral function.
user space	The bank 0 space of the register map. The registers in this bank are more likely to be modified during normal program execution and not just during initialization. Registers in bank 1 are most likely to be modified only during the initialization phase of the program.
$V_{DD}$	A name for a power net meaning "voltage drain." The most positive power supply signal. Usually 5 V or 3.3 V.
$V_{SS}$	A name for a power net meaning "voltage source." The most negative power supply signal.
watchdog timer	A timer that must be serviced periodically. If it is not serviced, the CPU resets after a specified period of time.

## Appendix: Silicon Errata for the PSoC® CY8C21x45, CY8C22x45 Product Family

This section describes the errata for the CY8C21x45, CY8C22x45 family of PSoC devices. Details include errata trigger conditions, scope of impact, available workarounds, and silicon revision applicability.

Contact your local Cypress Sales Representative if you have questions.

### Part Numbers Affected

Part Number	Device Characteristics
CY8C21345	All Variants
CY8C21645	All Variants
CY8C22045	All Variants
CY8C22345	All Variants
CY8C22545	All Variants
CY8C22645	All Variants

### CY8C21x45, CY8C22x45 Qualification Status

Product Status: In Production

### Errata Summary

The following table defines the errata applicable for this PSoC family device.

Items	Part Number	Silicon Revision	Fix Status
1. Free Running Nonstop Reading cause 7 LSB Pseudo Code Variation in SAR10ADC	All CY8C21x45, CY8C22x45 devices affected	All	Silicon fix not planned. Use workaround.
2. Internal Main Oscillator (IMO) Tolerance Deviation at Temperature Extremes	All CY8C21x45, CY8C22x45 devices affected	All	Silicon fix not planned. Use workaround.

#### 1. Free Running Nonstop Reading cause 7 LSB Pseudo Code Variation in SAR10ADC

##### ■ Problem Definition

In free running mode, there can be a variation of up to 7 LSB in the digital output of SAR10 ADC.

##### ■ Parameters Affected

Code Variation. This is not a specified parameter.

It is defined as the number of unique output codes generated by the ADC for a given constant input voltage, in addition to the correct code. For example, for an input voltage of 2.000 V, the expected code is 190hex and the ADC generates three codes: 191hex, 190hex, and 192hex. The code variation is 2 LSB.

##### ■ Trigger Condition(S)

SAR10 ADC is configured in the free running mode.

##### ■ Scope of Impact

Inaccurate output is possible.

##### ■ Workaround

This issue can be averted by using one or both of the following workarounds. Consult a Cypress representative for additional assistance.

- Use the averaging technique. That is, take multiple samples of the input, and use a digital averaging filter.
- Disable the free running mode before reading data out, and enable the free running mode after completing the read operation.

##### ■ Fix Status

No silicon fix is planned.

## 2. Internal Main Oscillator (IMO) Tolerance Deviation at Temperature Extremes

### ■ Problem Definition

Asynchronous Digital Communications Interfaces may fail framing beyond 0 to 70 °C. This problem does not affect end-product usage between 0 and 70 °C.

### ■ Parameters Affected

The IMO frequency tolerance. The worst case deviation when operated below 0 °C and above +70 °C and within the upper and lower datasheet temperature range is  $\pm 5\%$ .

### ■ Trigger Condition(S)

The asynchronous Rx/Tx clock source IMO frequency tolerance may deviate beyond the datasheet limit of  $\pm 2.5\%$  when operated beyond the temperature range of 0 to +70 °C.

### ■ Scope of Impact

This problem may affect UART, IrDA, and FSK implementations.

### ■ Workaround

Implement a quartz crystal stabilized clock source on at least one end of the asynchronous digital communications interface.

### ■ Fix Status

The cause of this problem and its solution has been identified. No silicon fix is planned to correct the deficiency in silicon.

## Document History Page

Document Title: CY8C21345, CY8C22345, CY8C22545, PSoC® Programmable System-on-Chip				
Document Number: 001-43084				
Revision	ECN	Orig. of Change	Submission Date	Description of Change
**	2251907	PMP / AESA	See ECN	New data sheet.
*A	2506377	EIJ / AESA	See ECN	Changed data sheet status to "Preliminary". Changed part numbers to CY8C22x45. Updated data sheet template. Added 56-Pin OCD information. Added: "You must put filters on intended ADC input channels for anti-aliasing. This ensures that any out-of-band content is not folded into the Input Signal Band." To Section <a href="#">Analog System on page 4</a> . Corrected Minimum Electro Static Discharge Voltage in <a href="#">Table 7 on page 14</a> .
*B	2558750	PMP / AESA	08/28/2008	Updated <a href="#">Features on page 1</a> , <a href="#">PSoC Core on page 3</a> , <a href="#">Analog System on page 4</a> . Changed DBB to DBC, and DCB to DCC in Register Tables <a href="#">Table 5 on page 11</a> and <a href="#">Table 6 on page 12</a> . Removed INL at 8 bit reference in <a href="#">Table 14 on page 18</a> . Changed IDD3 value <a href="#">Table 16 on page 19</a> Typ:3.3 mA, Max 6 mA Added "3.0 V < Vdd < 3.6 V and -40C < T <sub>A</sub> < 85C, IMO can guarantee 5% accuracy only" to <a href="#">Table 19 on page 21</a> . Updated data sheet template.
*C	2606793	NUQ / AESA	11/19/2008	Updated data sheet status to "Final". Updated block diagram on page 1. Removed CY8C22045 56-Pin OCD information. Added part numbers CY8C21345, CY8C22345, and CY8C22545. For more details, see CDT 31271.
*D	2615697	PMP / AESA	12/03/2008	Confirmed CY8C22345 and CY8C21345 have same pinout on page 8. Confirmed that IMO has 5% accuracy in <a href="#">Table 19 on page 21</a> .
*E	2631733	PMP / PYRS	01/07/2009	Updated Table 16. SAR10 ADC DC Specifications and Table 29 AC Programming Specifications. Title changed to "CY8C21345, CY8C22345, CY8C22545 PSoC® Programmable System-on-Chip™"
*F	2648800	JHU / AESA	01/28/2009	Updated INL, DNL information in <a href="#">Table 14 on page 18</a> , <a href="#">Development Tools on page 6</a> , and T <sub>DSCLK</sub> parameter in <a href="#">Table 27 on page 25</a> .
*G	2658078	HMI / AESA	02/11/2009	Updated section <a href="#">Features on page 1</a> .
*H	2667311	JHU / AESA	03/16/2009	Added parameter "F <sub>32KU</sub> " and added Min% and Max % to parameter "F <sub>IMO6</sub> " in <a href="#">Table 19 on page 21</a> , according to updated SLIMO spec.
*I	2748976	JZHU / PYRS	08/06/2009	Updated F <sub>32K1</sub> max rating in <a href="#">Table 19 on page 21</a> .
*J	2786560	JZHU	10/23/2009	Added DC <sub>ILO</sub> , T <sub>ERASEALL</sub> , T <sub>PROGRAM_HOT</sub> , T <sub>PROGRAM_COLD</sub> , SR <sub>POWERUP</sub> , I <sub>OH</sub> , and I <sub>OL</sub> parameters. Added Tape and Reel parts in Ordering Information table
*K	2901653	NJF	03/30/2010	Updated <a href="#">PSoC Designer Software Subsystems</a> . Added T <sub>BAKETEMP</sub> and T <sub>BAKETIME</sub> parameters in <a href="#">Absolute Maximum Ratings Modified Note 6 on page 17</a> . Added F <sub>OUT48M</sub> parameter in <a href="#">5 V and 3.3 V AC Chip-Level Specifications</a> . Removed AC Analog Mux Bus Specifications. Updated <a href="#">Ordering Code Definitions</a> . Updated links in <a href="#">Sales, Solutions, and Legal Information</a> .
*L	3114978	NJF	12/19/10	Added DC I <sup>2</sup> C Specifications. Added T <sub>jitter_IMO</sub> specification, removed existing jitter specifications. Updated DC Programming Specifications. Updated AC Digital Block Specifications. Updated I <sup>2</sup> C Timing Diagram. Added Solder Reflow Peak Temperature table. Updated Units of Measure, Acronyms, Glossary, and References sections.

**Document History Page** (continued)

Document Title: CY8C21345, CY8C22345, CY8C22545, PSoC® Programmable System-on-Chip Document Number: 001-43084				
Revision	ECN	Orig. of Change	Submission Date	Description of Change
*M	3231771	BOBH / ECU	04/18/11	Updated analog inputs column in <a href="#">Table 31 on page 28</a> and included reference to Note 18. Updated the following sections: <a href="#">Getting Started</a> , <a href="#">Development Tools</a> , and <a href="#">Designing with PSoC Designer</a> as all the System level designs have been de-emphasized. Updated <a href="#">Table 30</a> , " <a href="#">Solder Reflow Specifications</a> ," on page 28. Updated package diagrams: 51-85026 to *F 51-85064 to *E
*N	3578757	PMAD	04/11/2012	Removed reference to AN2012 as the document is in obsolete status. Updated template. No technical updates. Completing sunset review.
*O	3598230	LURE / XZNG	04/24/2012	Changed the PWM description string from "8- to 32-bit" to "8- and 16-bit".
*P	3915358	SAMP	02/27/2013	Updated <a href="#">Electrical Specifications</a> (Updated <a href="#">DC Electrical Characteristics</a> (Updated <a href="#">DC GPIO Specifications</a> (Updated <a href="#">Table 10</a> (Updated Notes for $V_{OH}$ and $V_{OL}$ parameters))))).
*Q	3959550	SAMP	04/09/2013	Added <a href="#">Appendix: Silicon Errata for the PSoC® CY8C21x45, CY8C22x45 Product Family</a> .

## Sales, Solutions, and Legal Information

### Worldwide Sales and Design Support

Cypress maintains a worldwide network of offices, solution centers, manufacturer's representatives, and distributors. To find the office closest to you, visit us at [Cypress Locations](#).

#### Products

Automotive	<a href="http://cypress.com/go/automotive">cypress.com/go/automotive</a>
Clocks & Buffers	<a href="http://cypress.com/go/clocks">cypress.com/go/clocks</a>
Interface	<a href="http://cypress.com/go/interface">cypress.com/go/interface</a>
Lighting & Power Control	<a href="http://cypress.com/go/powerpsoc">cypress.com/go/powerpsoc</a> <a href="http://cypress.com/go/plc">cypress.com/go/plc</a>
Memory	<a href="http://cypress.com/go/memory">cypress.com/go/memory</a>
PSoC	<a href="http://cypress.com/go/psoc">cypress.com/go/psoc</a>
Touch Sensing	<a href="http://cypress.com/go/touch">cypress.com/go/touch</a>
USB Controllers	<a href="http://cypress.com/go/USB">cypress.com/go/USB</a>
Wireless/RF	<a href="http://cypress.com/go/wireless">cypress.com/go/wireless</a>

#### PSoC Solutions

[psoc.cypress.com/solutions](http://psoc.cypress.com/solutions)

PSoC 1 | PSoC 3 | PSoC 5

---

© Cypress Semiconductor Corporation, 2008-2013. The information contained herein is subject to change without notice. Cypress Semiconductor Corporation assumes no responsibility for the use of any circuitry other than circuitry embodied in a Cypress product. Nor does it convey or imply any license under patent or other rights. Cypress products are not warranted nor intended to be used for medical, life support, life saving, critical control or safety applications, unless pursuant to an express written agreement with Cypress. Furthermore, Cypress does not authorize its products for use as critical components in life-support systems where a malfunction or failure may reasonably be expected to result in significant injury to the user. The inclusion of Cypress products in life-support systems application implies that the manufacturer assumes all risk of such use and in doing so indemnifies Cypress against all charges.

Any Source Code (software and/or firmware) is owned by Cypress Semiconductor Corporation (Cypress) and is protected by and subject to worldwide patent protection (United States and foreign), United States copyright laws and international treaty provisions. Cypress hereby grants to licensee a personal, non-exclusive, non-transferable license to copy, use, modify, create derivative works of, and compile the Cypress Source Code and derivative works for the sole purpose of creating custom software and or firmware in support of licensee product to be used only in conjunction with a Cypress integrated circuit as specified in the applicable agreement. Any reproduction, modification, translation, compilation, or representation of this Source Code except as specified above is prohibited without the express written permission of Cypress.

Disclaimer: CYPRESS MAKES NO WARRANTY OF ANY KIND, EXPRESS OR IMPLIED, WITH REGARD TO THIS MATERIAL, INCLUDING, BUT NOT LIMITED TO, THE IMPLIED WARRANTIES OF MERCHANTABILITY AND FITNESS FOR A PARTICULAR PURPOSE. Cypress reserves the right to make changes without further notice to the materials described herein. Cypress does not assume any liability arising out of the application or use of any product or circuit described herein. Cypress does not authorize its products for use as critical components in life-support systems where a malfunction or failure may reasonably be expected to result in significant injury to the user. The inclusion of Cypress' product in a life-support systems application implies that the manufacturer assumes all risk of such use and in doing so indemnifies Cypress against all charges.

Use may be limited by and subject to the applicable Cypress software license agreement.