



72-Mbit (2 M × 36/4 M × 18) Pipelined SRAM with NoBL™ Architecture

Features

- Pin-compatible and functionally equivalent to ZBT™
- Supports 250 MHz bus operations with zero wait states
 - Available speed grades are 250, 200, and 167 MHz
- Internally self-timed output buffer control to eliminate the need to use asynchronous OE
- Fully registered (inputs and outputs) for pipelined operation
- Byte Write capability
- Single 2.5 V power supply
- 2.5 V I/O supply (V_{DDQ})
- Fast clock-to-output times
 - 3.0 ns (for 250-MHz device)
- Clock Enable ($\overline{\text{CEN}}$) pin to suspend operation
- Synchronous self-timed writes
- CY7C1470BV25 available in JEDEC-standard Pb-free 100-pin TQFP and Pb-free 165-ball FBGA package. CY7C1472BV25 available in JEDEC-standard Pb-free 100-pin TQFP
- IEEE 1149.1 JTAG Boundary Scan compatible
- Burst capability – linear or interleaved burst order
- “ZZ” Sleep Mode option and Stop Clock option

Functional Description

The CY7C1470BV25 and CY7C1472BV25 are 2.5 V, 2 M × 36/4 M × 18 synchronous pipelined burst SRAMs with No Bus Latency™ (NoBL™) logic, respectively. They are designed to support unlimited true back-to-back read or write operations with no wait states. The CY7C1470BV25 and CY7C1472BV25 are equipped with the advanced (NoBL) logic required to enable consecutive read or write operations with data being transferred on every clock cycle. This feature dramatically improves the throughput of data in systems that require frequent read or write transitions. The CY7C1470BV25 and CY7C1472BV25 are pin-compatible and functionally equivalent to ZBT devices.

All synchronous inputs pass through input registers controlled by the rising edge of the clock. All data outputs pass through output registers controlled by the rising edge of the clock. The clock input is qualified by the Clock Enable (CEN) signal, which when deasserted suspends operation and extends the previous clock cycle. Write operations are controlled by the Byte Write Selects (BW_a–BW_d for CY7C1470BV25 and BW_a–BW_b for CY7C1472BV25) and a Write Enable (WE) input. All writes are conducted with on-chip synchronous self-timed write circuitry.

Three synchronous Chip Enables ($\overline{\text{CE}}_1$, $\overline{\text{CE}}_2$, $\overline{\text{CE}}_3$) and an asynchronous Output Enable ($\overline{\text{OE}}$) provide for easy bank selection and output tri-state control. To avoid bus contention, the output drivers are synchronously tri-stated during the data portion of a write sequence.

Selection Guide

Description	250 MHz	200 MHz	167 MHz	Unit
Maximum Access Time	3.0	3.0	3.4	ns
Maximum Operating Current	450	450	400	mA
Maximum CMOS Standby Current	120	120	120	mA

Logic Block Diagram – CY7C1470BV25

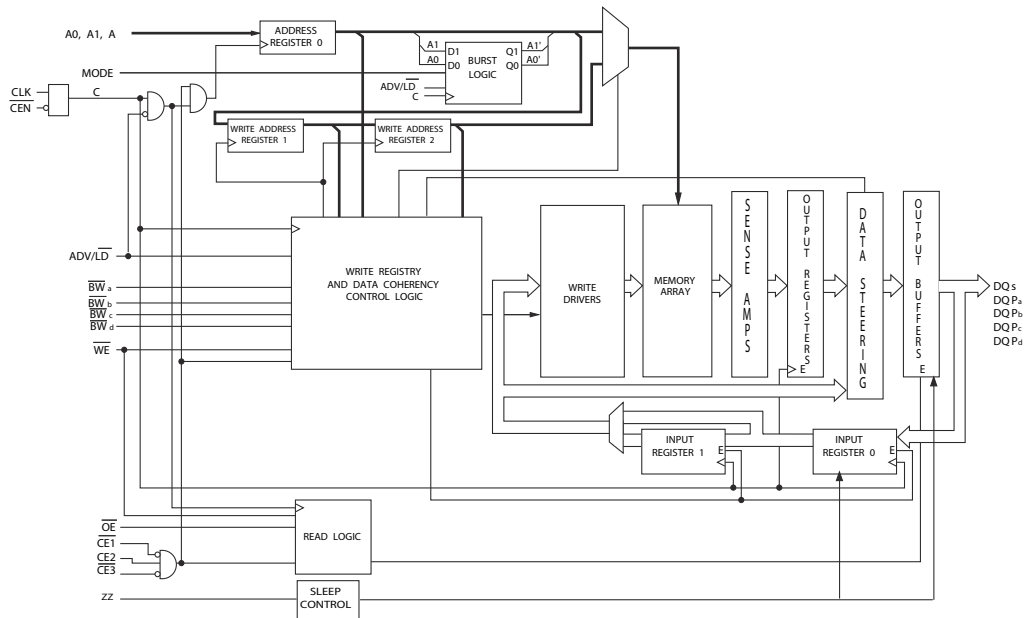

Logic Block Diagram – CY7C1472BV25

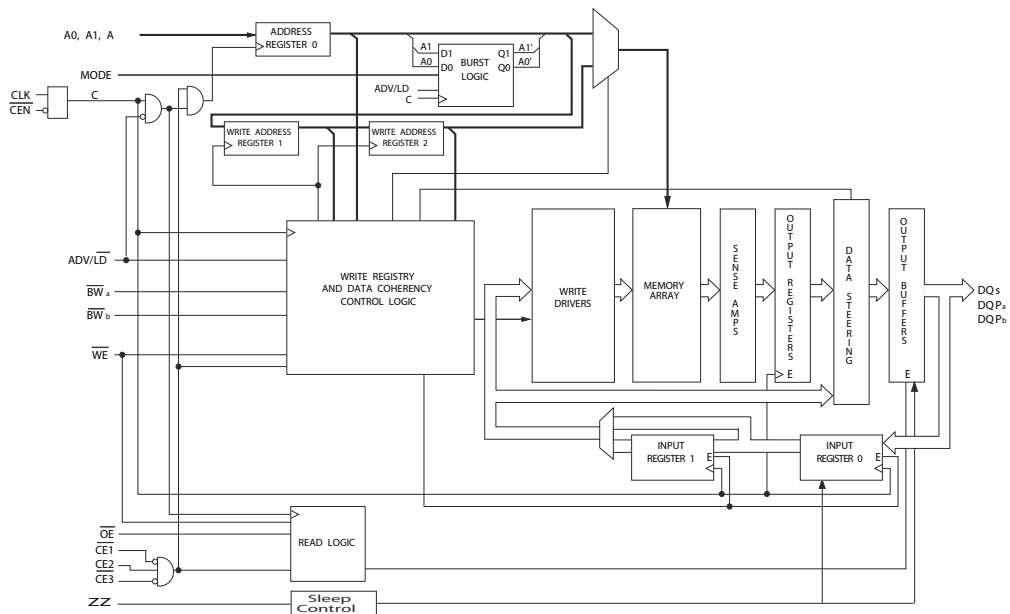

Contents

Pin Configurations	4	TAP DC Electrical Characteristics and	
Pin Definitions	6	Operating Conditions	15
Functional Overview	7	Identification Register Definitions	16
Single Read Accesses	7	Scan Register Sizes	16
Burst Read Accesses	7	Identification Codes	16
Single Write Accesses	7	Boundary Scan Exit Order	17
Burst Write Accesses	8	Maximum Ratings	18
Sleep Mode	8	Operating Range	18
Linear Burst Address Table	8	Electrical Characteristics	18
Interleaved Burst Address Table	8	Capacitance	19
ZZ Mode Electrical Characteristics	8	Thermal Resistance	19
Truth Table	9	AC Test Loads and Waveforms	19
Partial Write Cycle Description	10	Switching Characteristics	20
IEEE 1149.1 Serial Boundary Scan (JTAG)	11	Switching Waveforms	21
Disabling the JTAG Feature	11	Ordering Information	23
Test Access Port (TAP)	11	Ordering Code Definitions	23
Performing a TAP RESET	11	Package Diagrams	24
TAP Registers	11	Acronyms	26
TAP Instruction Set	11	Document Conventions	26
TAP Controller State Diagram	13	Units of Measure	26
TAP Controller Block Diagram	14	Document History Page	27
TAP Timing	14	Sales, Solutions, and Legal Information	29
TAP AC Switching Characteristics	15	Worldwide Sales and Design Support	29
2.5 V TAP AC Test Conditions	15	Products	29
2.5 V TAP AC Output Load Equivalent	15	PSoC Solutions	29

Pin Configurations

Figure 1. 100-pin TQFP (14 × 20 × 1.4 mm) pinout

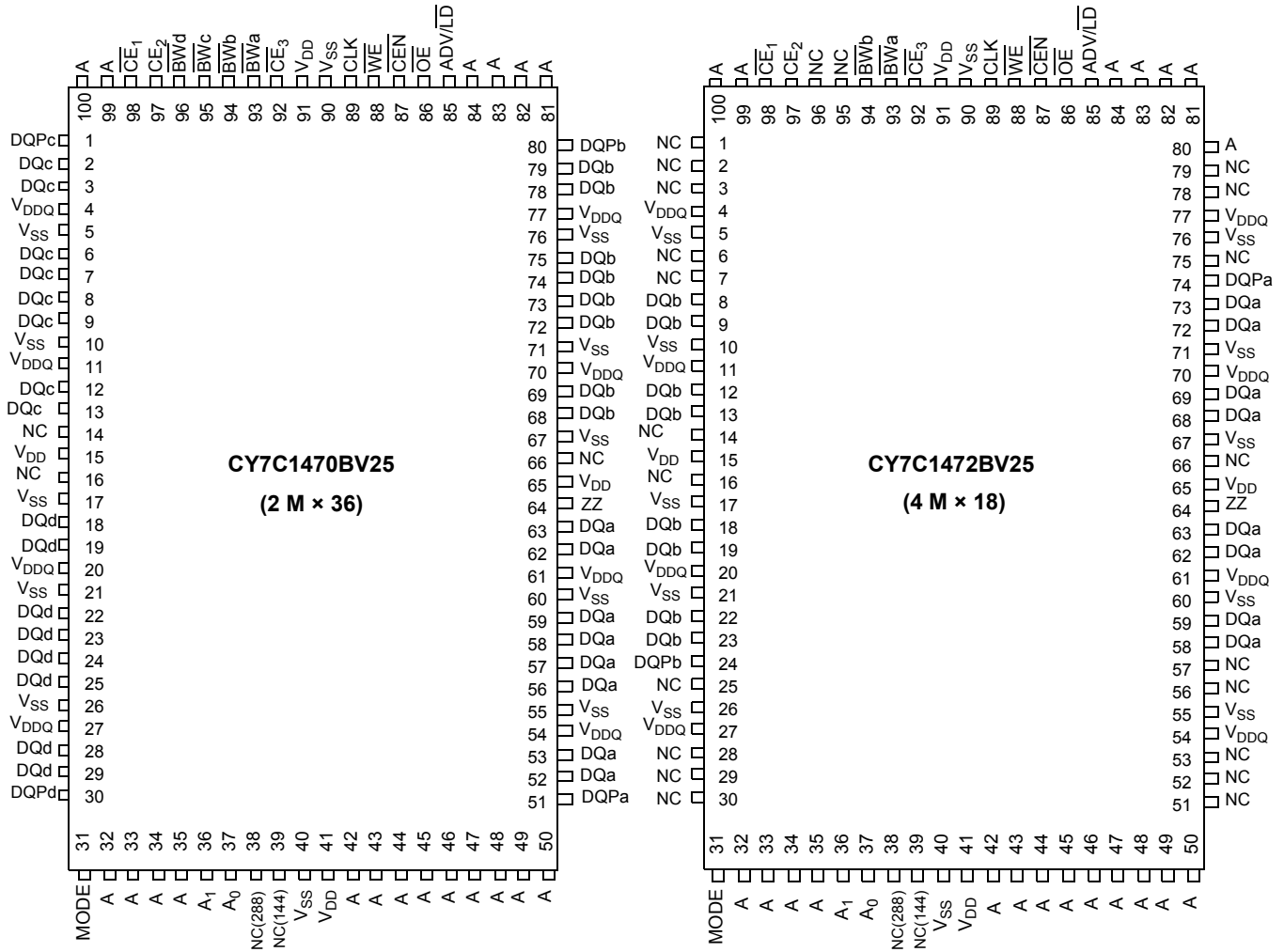

Pin Configurations (continued)

Figure 2. 165-ball FBGA (15 × 17 × 1.4 mm) pinout

CY7C1470BV25 (2 M × 36)

	1	2	3	4	5	6	7	8	9	10	11
A	NC/576M	A	\overline{CE}_1	\overline{BW}_c	\overline{BW}_b	\overline{CE}_3	\overline{CEN}	ADV/LD	A	A	NC
B	NC/1G	A	CE2	\overline{BW}_d	\overline{BW}_a	CLK	\overline{WE}	\overline{OE}	A	A	NC
C	DQP _c	NC	V _{DDQ}	V _{SS}	V _{SS}	V _{SS}	V _{SS}	V _{SS}	V _{DDQ}	NC	DQP _b
D	DQ _c	DQ _c	V _{DDQ}	V _{DD}	V _{SS}	V _{SS}	V _{SS}	V _{DD}	V _{DDQ}	DQ _b	DQ _b
E	DQ _c	DQ _c	V _{DDQ}	V _{DD}	V _{SS}	V _{SS}	V _{SS}	V _{DD}	V _{DDQ}	DQ _b	DQ _b
F	DQ _c	DQ _c	V _{DDQ}	V _{DD}	V _{SS}	V _{SS}	V _{SS}	V _{DD}	V _{DDQ}	DQ _b	DQ _b
G	DQ _c	DQ _c	V _{DDQ}	V _{DD}	V _{SS}	V _{SS}	V _{SS}	V _{DD}	V _{DDQ}	DQ _b	DQ _b
H	NC	NC	NC	V _{DD}	V _{SS}	V _{SS}	V _{SS}	V _{DD}	NC	NC	ZZ
J	DQ _d	DQ _d	V _{DDQ}	V _{DD}	V _{SS}	V _{SS}	V _{SS}	V _{DD}	V _{DDQ}	DQ _a	DQ _a
K	DQ _d	DQ _d	V _{DDQ}	V _{DD}	V _{SS}	V _{SS}	V _{SS}	V _{DD}	V _{DDQ}	DQ _a	DQ _a
L	DQ _d	DQ _d	V _{DDQ}	V _{DD}	V _{SS}	V _{SS}	V _{SS}	V _{DD}	V _{DDQ}	DQ _a	DQ _a
M	DQ _d	DQ _d	V _{DDQ}	V _{DD}	V _{SS}	V _{SS}	V _{SS}	V _{DD}	V _{DDQ}	DQ _a	DQ _a
N	DQP _d	NC	V _{DDQ}	V _{SS}	NC	NC	NC	V _{SS}	V _{DDQ}	NC	DQP _a
P	NC/144M	A	A	A	TDI	A1	TDO	A	A	A	NC/288M
R	MODE	A	A	A	TMS	A0	TCK	A	A	A	A

Pin Definitions

Pin Name	I/O Type	Pin Description
A ₀ , A ₁ , A	Input-Synchronous	Address Inputs Used to Select One of the Address Locations. Sampled at the rising edge of the CLK.
BW _a , BW _b , BW _c , BW _d	Input-Synchronous	Byte Write Select Inputs, Active LOW. Qualified with \overline{WE} to conduct writes to the SRAM. Sampled on the rising edge of CLK. BW _a controls DQ _a and DQP _a , BW _b controls DQ _b and DQP _b , BW _c controls DQ _c and DQP _c , BW _d controls DQ _d and DQP _d .
\overline{WE}	Input-Synchronous	Write Enable Input, Active LOW. Sampled on the rising edge of CLK if \overline{CEN} is active LOW. This signal must be asserted LOW to initiate a write sequence.
ADV/LD	Input-Synchronous	Advance/Load Input Used to Advance the On-Chip Address Counter or Load a New Address. When HIGH (and \overline{CEN} is asserted LOW) the internal burst counter is advanced. When LOW, a new address can be loaded into the device for an access. After being deselected, ADV/LD must be driven LOW to load a new address.
CLK	Input-Clock	Clock Input. Used to capture all synchronous inputs to the device. CLK is qualified with \overline{CEN} . CLK is only recognized if \overline{CEN} is active LOW.
\overline{CE}_1	Input-Synchronous	Chip Enable 1 Input, Active LOW. Sampled on the rising edge of CLK. Used in conjunction with \overline{CE}_2 and \overline{CE}_3 to select/deselect the device.
\overline{CE}_2	Input-Synchronous	Chip Enable 2 Input, Active HIGH. Sampled on the rising edge of CLK. Used in conjunction with \overline{CE}_1 and \overline{CE}_3 to select/deselect the device.
\overline{CE}_3	Input-Synchronous	Chip Enable 3 Input, Active LOW. Sampled on the rising edge of CLK. Used in conjunction with \overline{CE}_1 and \overline{CE}_2 to select/deselect the device.
\overline{OE}	Input-Asynchronous	Output Enable, Active LOW. Combined with the synchronous logic block inside the device to control the direction of the I/O pins. When LOW, the I/O pins can behave as outputs. When deasserted HIGH, I/O pins are tri-stated, and act as input data pins. \overline{OE} is masked during the data portion of a write sequence, during the first clock when emerging from a deselected state and when the device has been deselected.
\overline{CEN}	Input-Synchronous	Clock Enable Input, Active LOW. When asserted LOW the clock signal is recognized by the SRAM. When deasserted HIGH the clock signal is masked. Since deasserting \overline{CEN} does not deselect the device, \overline{CEN} can be used to extend the previous cycle when required.
DQ _s	I/O-Synchronous	Bidirectional Data I/O Lines. As inputs, they feed into an on-chip data register that is triggered by the rising edge of CLK. As outputs, they deliver the data contained in the memory location specified by A _[18:0] during the previous clock rise of the read cycle. The direction of the pins is controlled by \overline{OE} and the internal control logic. When \overline{OE} is asserted LOW, the pins can behave as outputs. When HIGH, DQ _a –DQ _d are placed in a tri-state condition. The outputs are automatically tri-stated during the data portion of a write sequence, during the first clock when emerging from a deselected state, and when the device is deselected, regardless of the state of \overline{OE} .
DQP _x	I/O-Synchronous	Bidirectional Data Parity I/O Lines. Functionally, these signals are identical to DQ _[71:0] . During write sequences, DQP _a is controlled by BW _a , DQP _b is controlled by BW _b , DQP _c is controlled by BW _c , and DQP _d is controlled by BW _d .
MODE	Input Strap Pin	Mode Input. Selects the burst order of the device. Tied HIGH selects the interleaved burst order. Pulled LOW selects the linear burst order. MODE must not change states during operation. When left floating MODE defaults HIGH, to an interleaved burst order.
TDO	JTAG Serial Output Synchronous	Serial Data Out to the JTAG Circuit. Delivers data on the negative edge of TCK.
TDI	JTAG Serial Input Synchronous	Serial Data In to the JTAG Circuit. Sampled on the rising edge of TCK.
TMS	Test Mode Select Synchronous	TMS Pin Controls the Test Access Port State Machine. Sampled on the rising edge of TCK.

Pin Definitions (continued)

Pin Name	I/O Type	Pin Description
TCK	JTAG Clock	Clock Input to the JTAG Circuitry.
V _{DD}	Power Supply	Power Supply Inputs to the Core of the Device.
V _{DDQ}	I/O Power Supply	Power Supply for the I/O Circuitry.
V _{SS}	Ground	Ground for the Device. Must be connected to ground of the system.
NC	–	No Connects. This pin is not connected to the die.
NC (144M, 288M, 576M, 1G)	–	These Pins are Not Connected. They are used for expansion to the 144M, 288M, 576M, and 1G densities.
ZZ	Input-Asynchronous	ZZ “Sleep” Input. This active HIGH input places the device in a non-time critical “sleep” condition with data integrity preserved. For normal operation, this pin has must be LOW or left floating. ZZ pin has an internal pull down.

Functional Overview

The CY7C1470BV25 and CY7C1472BV25 are synchronous-pipelined Burst NoBL SRAMs designed specifically to eliminate wait states during read or write transitions. All synchronous inputs pass through input registers controlled by the rising edge of the clock. The clock signal is qualified with the Clock Enable input signal (CEN). If CEN is HIGH, the clock signal is not recognized and all internal states are maintained. All synchronous operations are qualified with CEN. All data outputs pass through output registers controlled by the rising edge of the clock. Maximum access delay from the clock rise (t_{CO}) is 3.0 ns (250-MHz device).

Accesses can be initiated by asserting all three Chip Enables (\overline{CE}_1 , CE_2 , \overline{CE}_3) active at the rising edge of the clock. If CEN is active LOW and ADV/LD is asserted LOW, the address presented to the device is latched. The access can either be a read or write operation, depending on the status of the Write Enable (WE). $BW_{[x]}$ can be used to conduct Byte Write operations.

Write operations are qualified by the Write Enable (\overline{WE}). All writes are simplified with on-chip synchronous self-timed write circuitry.

Three synchronous Chip Enables (\overline{CE}_1 , CE_2 , \overline{CE}_3) and an asynchronous Output Enable (\overline{OE}) simplify depth expansion. All operations (reads, writes, and deselections) are pipelined. ADV/LD must be driven LOW after the device is deselected to load a new address for the next operation.

Single Read Accesses

A read access is initiated when the following conditions are satisfied at clock rise: (1) \overline{CEN} is asserted LOW, (2) \overline{CE}_1 , CE_2 , and \overline{CE}_3 are ALL asserted active, (3) the input signal WE is deasserted HIGH, and (4) ADV/LD is asserted LOW. The address presented to the address inputs is latched into the Address Register and presented to the memory core and control logic. The control logic determines that a read access is in progress and allows the requested data to propagate to the input of the output register. At the rising edge of the next clock the requested data is allowed to propagate through the output register and onto the data bus within 2.6 ns (250-MHz device) provided \overline{OE} is active LOW. After the first clock of the read

access the output buffers are controlled by \overline{OE} and the internal control logic. \overline{OE} must be driven LOW to drive out the requested data. During the second clock, a subsequent operation (read, write, or deselect) can be initiated. Deselecting the device is also pipelined. Therefore, when the SRAM is deselected at clock rise by one of the chip enable signals, its output tri-states following the next clock rise.

Burst Read Accesses

The CY7C1470BV25 and CY7C1472BV25 have an on-chip burst counter that enables the user to supply a single address and conduct up to four reads without reasserting the address inputs. ADV/LD must be driven LOW to load a new address into the SRAM, as described in the [Single Read Accesses](#) section. The sequence of the burst counter is determined by the MODE input signal. A LOW input on MODE selects a linear burst mode, a HIGH selects an interleaved burst sequence. Both burst counters use A0 and A1 in the burst sequence, and wraps around when incremented sufficiently. A HIGH input on ADV/LD increments the internal burst counter regardless of the state of chip enables inputs or WE. WE is latched at the beginning of a burst cycle. Therefore, the type of access (read or write) is maintained throughout the burst sequence.

Single Write Accesses

Write accesses are initiated when the following conditions are satisfied at clock rise: (1) \overline{CEN} is asserted LOW, (2) \overline{CE}_1 , CE_2 , and \overline{CE}_3 are ALL asserted active, and (3) the signal WE is asserted LOW. The address presented to the address inputs is loaded into the Address Register. The write signals are latched into the Control Logic block.

On the subsequent clock rise the data lines are automatically tri-stated regardless of the state of the \overline{OE} input signal. This allows the external logic to present the data on DQ and DQP ($DQ_{a,b,c,d}/DQP_{a,b,c,d}$ for CY7C1470BV25, $DQ_{a,b}/DQP_{a,b}$ for CY7C1472BV25). In addition, the address for the subsequent access (read, write, or deselect) is latched into the Address Register (provided the appropriate control signals are asserted).

On the next clock rise the data presented to DQ and DQP ($DQ_{a,b,c,d}/DQP_{a,b,c,d}$ for CY7C1470BV25, $DQ_{a,b}/DQP_{a,b}$ for CY7C1472BV25) (or a subset for Byte Write operations, see [Partial Write Cycle Description on page 10](#) for details) inputs is

latched into the device and the Write is complete.

The data written during the Write operation is controlled by \overline{BW} ($\overline{BW}_{a,b,c,d}$ for CY7C1470BV25 and $\overline{BW}_{a,b}$ for CY7C1472BV25) signals. The CY7C1470BV25 and CY7C1472BV25 provides Byte Write capability that is described in [Partial Write Cycle Description on page 10](#). Asserting the \overline{WE} input with the selected \overline{BW} input selectively writes to only the desired bytes. Bytes not selected during a Byte Write operation remain unaltered. A synchronous self-timed write mechanism has been provided to simplify the write operations. Byte Write capability has been included to greatly simplify read, modify, or write sequences, which can be reduced to simple Byte Write operations.

Because the CY7C1470BV25 and CY7C1472BV25 are common I/O devices, data must not be driven into the device while the outputs are active. OE can be deasserted HIGH before presenting data to the DQ and DQP ($DQ_{a,b,c,d}/DQP_{a,b,c,d}$ for CY7C1470BV25, $DQ_{a,b}/DQP_{a,b}$ for CY7C1472BV25) inputs. Doing so tri-states the output drivers. As a safety precaution, DQ and DQP ($DQ_{a,b,c,d}/DQP_{a,b,c,d}$ for CY7C1470BV25, $DQ_{a,b}/DQP_{a,b}$ for CY7C1472BV25) are automatically tri-stated during the data portion of a write cycle, regardless of the state of OE.

Burst Write Accesses

The CY7C1470BV25 and CY7C1472BV25 has an on-chip burst counter that enables the user to supply a single address and conduct up to four write operations without reasserting the address inputs. ADV/LD must be driven LOW to load the initial address, as described in [Single Write Accesses on page 7](#). When ADV/LD is driven HIGH on the subsequent clock rise, the Chip Enables (\overline{CE}_1 , \overline{CE}_2 , and \overline{CE}_3) and \overline{WE} inputs are ignored and the burst counter is incremented. The correct \overline{BW} ($\overline{BW}_{a,b,c,d}$ for CY7C1470BV25, $\overline{BW}_{a,b}$ for CY7C1472BV25) inputs must be driven in each cycle of the burst write to write the correct bytes of data.

ZZ Mode Electrical Characteristics

Parameter	Description	Test Conditions	Min	Max	Unit
I_{DDZZ}	Sleep mode standby current	$ZZ \geq V_{DD} - 0.2 V$	–	120	mA
t_{ZZS}	Device operation to ZZ	$ZZ \geq V_{DD} - 0.2 V$	–	$2t_{CYC}$	ns
t_{ZZREC}	ZZ recovery time	$ZZ \leq 0.2 V$	$2t_{CYC}$	–	ns
t_{ZZI}	ZZ active to sleep current	This parameter is sampled	–	$2t_{CYC}$	ns
t_{RZZI}	ZZ Inactive to exit sleep current	This parameter is sampled	0	–	ns

Sleep Mode

The ZZ input pin is an asynchronous input. Asserting ZZ places the SRAM in a power conservation “sleep” mode. Two clock cycles are required to enter into or exit from this “sleep” mode. While in this mode, data integrity is guaranteed. Accesses pending when entering the “sleep” mode are not considered valid nor is the completion of the operation guaranteed. The device must be deselected before entering the “sleep” mode. \overline{CE}_1 , \overline{CE}_2 , and \overline{CE}_3 , must remain inactive for the duration of t_{ZZREC} after the ZZ input returns LOW.

Linear Burst Address Table

(MODE = GND)

First Address A1: A0	Second Address A1: A0	Third Address A1: A0	Fourth Address A1: A0
00	01	10	11
01	10	11	00
10	11	00	01
11	00	01	10

Interleaved Burst Address Table

(MODE = Floating or V_{DD})

First Address A1: A0	Second Address A1: A0	Third Address A1: A0	Fourth Address A1: A0
00	01	10	11
01	00	11	10
10	11	00	01
11	10	01	00

Truth Table

The truth table for CY7C1470BV25 and CY7C1472BV25 follows. [1, 2, 3, 4, 5, 6, 7]

Operation	Address Used	$\overline{\text{CE}}$	ZZ	$\overline{\text{ADV/LD}}$	$\overline{\text{WE}}$	$\overline{\text{BW}}_x$	$\overline{\text{OE}}$	$\overline{\text{CEN}}$	CLK	DQ
Deselect Cycle	None	H	L	L	X	X	X	L	L-H	Tri-State
Continue Deselect Cycle	None	X	L	H	X	X	X	L	L-H	Tri-State
Read Cycle (Begin Burst)	External	L	L	L	H	X	L	L	L-H	Data Out (Q)
Read Cycle (Continue Burst)	Next	X	L	H	X	X	L	L	L-H	Data Out (Q)
NOP/Dummy Read (Begin Burst)	External	L	L	L	H	X	H	L	L-H	Tri-State
Dummy Read (Continue Burst)	Next	X	L	H	X	X	H	L	L-H	Tri-State
Write Cycle (Begin Burst)	External	L	L	L	L	L	X	L	L-H	Data In (D)
Write Cycle (Continue Burst)	Next	X	L	H	X	L	X	L	L-H	Data In (D)
NOP/Write Abort (Begin Burst)	None	L	L	L	L	H	X	L	L-H	Tri-State
Write Abort (Continue Burst)	Next	X	L	H	X	H	X	L	L-H	Tri-State
Ignore Clock Edge (Stall)	Current	X	L	X	X	X	X	H	L-H	-
Sleep Mode	None	X	H	X	X	X	X	X	X	Tri-State

Notes

1. X = "Don't Care", H = Logic HIGH, L = Logic LOW, $\overline{\text{CE}}$ stands for ALL Chip Enables active. $\overline{\text{BW}}_x = \text{L}$ signifies that at least one Byte Write Select is active, $\overline{\text{BW}}_x = \text{Valid}$ signifies that the desired Byte Write Selects are asserted, see [Partial Write Cycle Description on page 10](#) for details.
2. Write is defined by $\overline{\text{WE}}$ and $\overline{\text{BW}}_{[a:d]}$. See [Partial Write Cycle Description on page 10](#) for details.
3. When a write cycle is detected, all IOs are tri-stated, even during Byte Writes.
4. The DQ and DQP pins are controlled by the current cycle and the $\overline{\text{OE}}$ signal.
5. $\overline{\text{CEN}} = \text{H}$ inserts wait states.
6. Device powers up deselected with the IOs in a tri-state condition, regardless of $\overline{\text{OE}}$.
7. $\overline{\text{OE}}$ is asynchronous and is not sampled with the clock rise. It is masked internally during write cycles. During a Read cycle DQ_s and $\text{DQP}_{[a:d]}$ = tri-state when $\overline{\text{OE}}$ is inactive or when the device is deselected, and DQ_s = data when $\overline{\text{OE}}$ is active.

Partial Write Cycle Description

The partial write cycle description for CY7C1470BV25 and CY7C1472BV25 follows. [8, 9, 10, 11]

Function (CY7C1470BV25)	\overline{WE}	$\overline{BW_d}$	$\overline{BW_c}$	$\overline{BW_b}$	$\overline{BW_a}$
Read	H	X	X	X	X
Write – No bytes written	L	H	H	H	H
Write Byte a – (DQ _a and DQP _a)	L	H	H	H	L
Write Byte b – (DQ _b and DQP _b)	L	H	H	L	H
Write Bytes b, a	L	H	H	L	L
Write Byte c – (DQ _c and DQP _c)	L	H	L	H	H
Write Bytes c, a	L	H	L	H	L
Write Bytes c, b	L	H	L	L	H
Write Bytes c, b, a	L	H	L	L	L
Write Byte d – (DQ _d and DQP _d)	L	L	H	H	H
Write Bytes d, a	L	L	H	H	L
Write Bytes d, b	L	L	H	L	H
Write Bytes d, b, a	L	L	H	L	L
Write Bytes d, c	L	L	L	H	H
Write Bytes d, c, a	L	L	L	H	L
Write Bytes d, c, b	L	L	L	L	H
Write All Bytes	L	L	L	L	L

Function (CY7C1472BV25)	\overline{WE}	$\overline{BW_b}$	$\overline{BW_a}$
Read	H	x	x
Write – No Bytes Written	L	H	H
Write Byte a – (DQ _a and DQP _a)	L	H	L
Write Byte b – (DQ _b and DQP _b)	L	L	H
Write Both Bytes	L	L	L

Notes

8. X = "Don't Care", H = Logic HIGH, L = Logic LOW, \overline{CE} stands for ALL Chip Enables active. $\overline{BW_x}$ = L signifies at least one Byte Write Select is active, $\overline{BW_x}$ = Valid signifies that the desired Byte Write Selects are asserted, see [Partial Write Cycle Description](#) for details.
9. Write is defined by \overline{WE} and $\overline{BW_{[a:d]}}$. See [Partial Write Cycle Description](#) for details.
10. When a write cycle is detected, all IOs are tri-stated, even during Byte Writes.
11. Table lists only a partial listing of the Byte Write combinations. Any combination of $\overline{BW_{[a:d]}}$ is valid. Appropriate write is based on which Byte Write is active.

IEEE 1149.1 Serial Boundary Scan (JTAG)

The CY7C1470BV25 incorporates a serial boundary scan test access port (TAP). This port operates in accordance with IEEE Standard 1149.1-1990 but does not have the set of functions required for full 1149.1 compliance. These functions from the IEEE specification are excluded because their inclusion places an added delay in the critical speed path of the SRAM. Note that the TAP controller functions in a manner that does not conflict with the operation of other devices using 1149.1 fully compliant TAPs. The TAP operates using JEDEC-standard 2.5 V I/O logic levels.

The CY7C1470BV25 contains a TAP controller, instruction register, boundary scan register, bypass register, and ID register.

Disabling the JTAG Feature

It is possible to operate the SRAM without using the JTAG feature. To disable the TAP controller, TCK must be tied LOW (V_{SS}) to prevent clocking of the device. TDI and TMS are internally pulled up and may be unconnected. They may alternately be connected to V_{DD} through a pull up resistor. TDO must be left unconnected. During power up, the device comes up in a reset state, which does not interfere with the operation of the device.

Test Access Port (TAP)

Test Clock (TCK)

The test clock is used only with the TAP controller. All inputs are captured on the rising edge of TCK. All outputs are driven from the falling edge of TCK.

Test Mode Select (TMS)

The TMS input is used to give commands to the TAP controller and is sampled on the rising edge of TCK. It is allowable to leave this ball unconnected if the TAP is not used. The ball is pulled up internally, resulting in a logic HIGH level.

Test Data-In (TDI)

The TDI ball is used to serially input information into the registers and can be connected to the input of any of the registers. The register between TDI and TDO is chosen by the instruction that is loaded into the TAP instruction register. For information about loading the instruction register, see the [TAP Controller State Diagram](#). TDI is internally pulled up and can be unconnected if the TAP is unused in an application. TDI is connected to the most significant bit (MSB) of any register.

Test Data-Out (TDO)

The TDO output ball is used to serially clock data-out from the registers. The output is active depending upon the current state of the TAP state machine (see [Identification Codes on page 16](#)). The output changes on the falling edge of TCK. TDO is connected to the least significant bit (LSB) of any register.

Performing a TAP RESET

A RESET is performed by forcing TMS HIGH (V_{DD}) for five rising edges of TCK. This RESET does not affect the operation of the SRAM and may be performed while the SRAM is operating.

During power up, the TAP is reset internally to ensure that TDO comes up in a High Z state.

TAP Registers

Registers are connected between the TDI and TDO balls to scan the data in and out of the SRAM test circuitry. Only one register can be selected at a time through the instruction register. Data is serially loaded into the TDI ball on the rising edge of TCK. Data is output on the TDO ball on the falling edge of TCK.

Instruction Register

Three-bit instructions can be serially loaded into the instruction register. This register is loaded when it is placed between the TDI and TDO balls as shown in the [TAP Controller Block Diagram on page 14](#). During power up, the instruction register is loaded with the IDCODE instruction. It is also loaded with the IDCODE instruction if the controller is placed in a reset state as described in the previous section.

When the TAP controller is in the Capture-IR state, the two least significant bits are loaded with a binary '01' pattern to enable fault isolation of the board-level serial test data path.

Bypass Register

To save time when serially shifting data through registers, it is sometimes advantageous to skip certain chips. The bypass register is a single-bit register that can be placed between the TDI and TDO balls. This shifts the data through the SRAM with minimal delay. The bypass register is set LOW (V_{SS}) when the BYPASS instruction is executed.

Boundary Scan Register

The boundary scan register is connected to all the input and bidirectional balls on the SRAM.

The boundary scan register is loaded with the contents of the RAM I/O ring when the TAP controller is in the Capture-DR state and is then placed between the TDI and TDO balls when the controller is moved to the Shift-DR state. The EXTEST, SAMPLE/PRELOAD and SAMPLE Z instructions can be used to capture the contents of the I/O ring.

The Boundary Scan Order tables show the order in which the bits are connected. Each bit corresponds to one of the bumps on the SRAM package. The MSB of the register is connected to TDI and the LSB is connected to TDO.

Identification (ID) Register

The ID register is loaded with a vendor-specific, 32-bit code during the Capture-DR state when the IDCODE command is loaded in the instruction register. The IDCODE is hardwired into the SRAM and can be shifted out when the TAP controller is in the Shift-DR state. The ID register has a vendor code and other information described in [Identification Register Definitions on page 16](#).

TAP Instruction Set

Overview

Eight different instructions are possible with the three-bit instruction register. All combinations are listed in [Identification Codes on page 16](#). Three of these instructions are listed as

RESERVED and must not be used. The other five instructions are described in this section in detail.

The TAP controller used in this SRAM is not fully compliant to the 1149.1 convention because some of the mandatory 1149.1 instructions are not fully implemented.

The TAP controller cannot be used to load address data or control signals into the SRAM and cannot preload the I/O buffers. The SRAM does not implement the 1149.1 commands EXTEST or INTEST or the PRELOAD portion of SAMPLE/PRELOAD; rather, it performs a capture of the I/O ring when these instructions are executed.

Instructions are loaded into the TAP controller during the Shift-IR state when the instruction register is placed between TDI and TDO. During this state, instructions are shifted through the instruction register through the TDI and TDO balls. To execute the instruction after it is shifted in, the TAP controller must be moved into the Update-IR state.

EXTEST

EXTEST is a mandatory 1149.1 instruction which is executed whenever the instruction register is loaded with all 0s. EXTEST is not implemented in this SRAM TAP controller, and therefore this device is not compliant to 1149.1. The TAP controller does not recognize an all-0 instruction.

When an EXTEST instruction is loaded into the instruction register, the SRAM responds as if a SAMPLE/PRELOAD instruction has been loaded. There is one difference between the two instructions. Unlike the SAMPLE/PRELOAD instruction, EXTEST places the SRAM outputs in a High Z state.

IDCODE

The IDCODE instruction loads a vendor-specific, 32-bit code into the instruction register. It also places the instruction register between the TDI and TDO balls and shifts the IDCODE out of the device when the TAP controller enters the Shift-DR state.

The IDCODE instruction is loaded into the instruction register during power up or whenever the TAP controller is in a test logic reset state.

SAMPLE Z

The SAMPLE Z instruction connects the boundary scan register between the TDI and TDO pins when the TAP controller is in a Shift-DR state. It also places all SRAM outputs into a High Z state.

SAMPLE/PRELOAD

SAMPLE/PRELOAD is a 1149.1 mandatory instruction. The PRELOAD portion of this instruction is not implemented, so the device TAP controller is not fully 1149.1 compliant.

When the SAMPLE/PRELOAD instruction is loaded into the instruction register and the TAP controller is in the Capture-DR state, a snapshot of data on the inputs and bidirectional balls is captured in the boundary scan register.

The user must be aware that the TAP controller clock can only operate at a frequency up to 20 MHz, while the SRAM clock operates more than an order of magnitude faster. Because there is a large difference in the clock frequencies, it is possible that during the Capture-DR state, an input or output may undergo a transition. The TAP may then try to capture a signal while in transition (metastable state). This does not harm the device, but there is no guarantee as to the value that is captured. Repeatable results may not be possible.

To guarantee that the boundary scan register captures the correct value of a signal, the SRAM signal must be stabilized long enough to meet the TAP controller's capture setup plus hold time (t_{CS} plus t_{CH}).

The SRAM clock input might not be captured correctly if there is no way in a design to stop (or slow) the clock during a SAMPLE/PRELOAD instruction. If this is an issue, it is still possible to capture all other signals and simply ignore the value of the CLK captured in the boundary scan register.

After the data is captured, it is possible to shift out the data by putting the TAP into the Shift-DR state. This places the boundary scan register between the TDI and TDO balls.

Note that since the PRELOAD part of the command is not implemented, putting the TAP to the Update-DR state while performing a SAMPLE/PRELOAD instruction has the same effect as the Pause-DR command.

BYPASS

When the BYPASS instruction is loaded in the instruction register and the TAP is placed in a Shift-DR state, the bypass register is placed between the TDI and TDO balls. The advantage of the BYPASS instruction is that it shortens the boundary scan path when multiple devices are connected together on a board.

Reserved

These instructions are not implemented but are reserved for future use. Do not use these instructions.

TAP Controller State Diagram

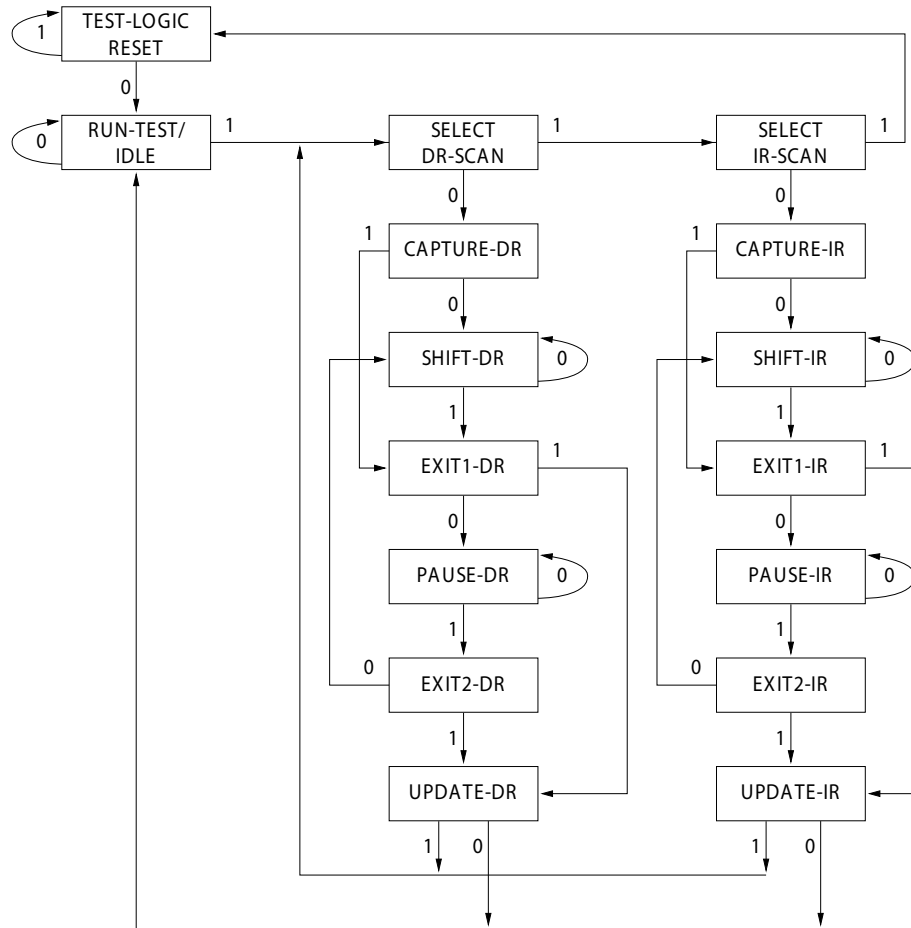

The 0/1 next to each state represents the value of TMS at the rising edge of TCK.

TAP Controller Block Diagram

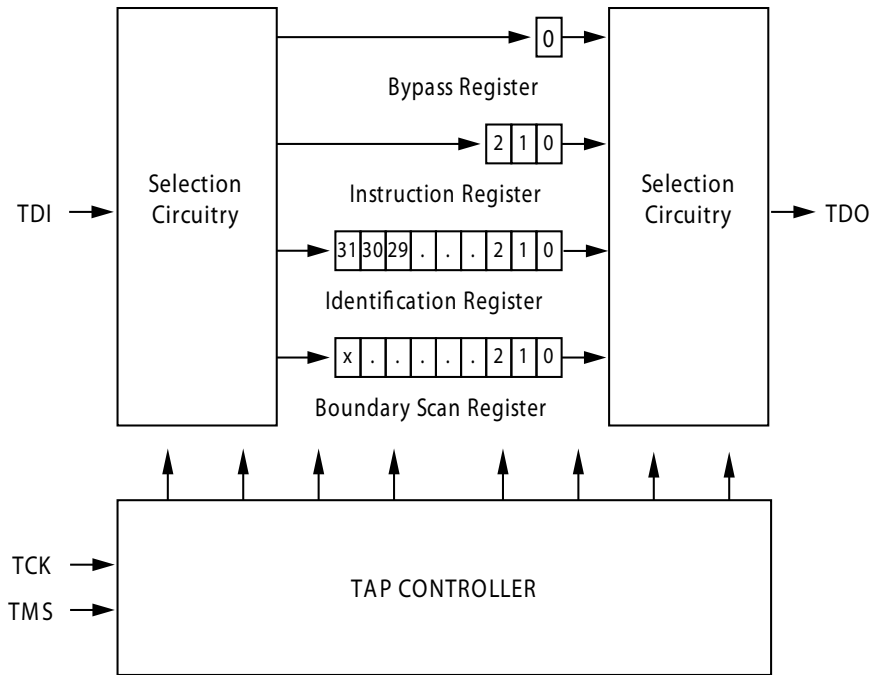

TAP Timing

Figure 3. TAP Timing

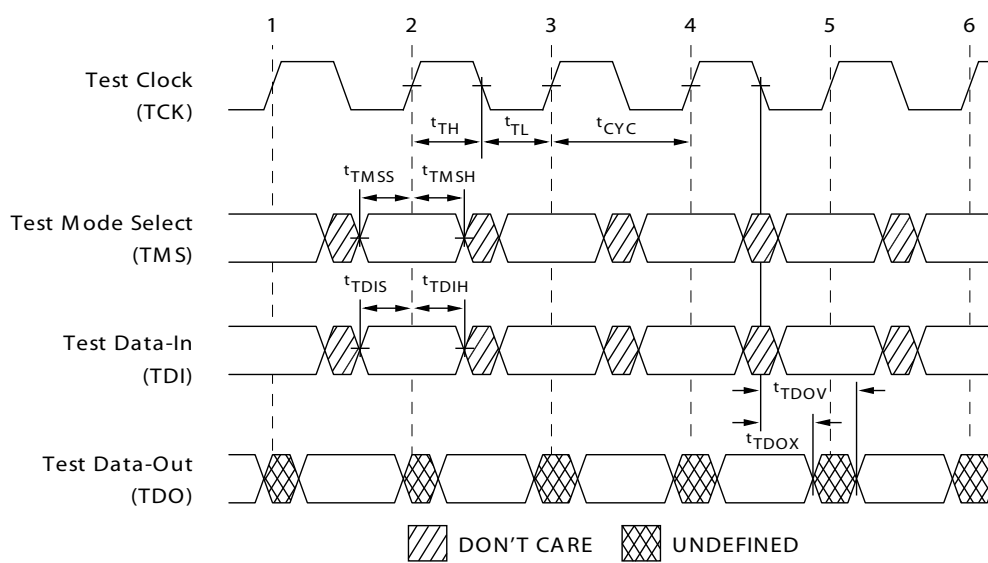

TAP AC Switching Characteristics

Over the Operating Range

Parameter ^[12, 13]	Description	Min	Max	Unit
Clock				
t_{TCYC}	TCK Clock Cycle Time	50	–	ns
t_{TF}	TCK Clock Frequency	–	20	MHz
t_{TH}	TCK Clock HIGH time	20	–	ns
t_{TL}	TCK Clock LOW time	20	–	ns
Output Times				
t_{TDOV}	TCK Clock LOW to TDO Valid	–	10	ns
t_{TDOX}	TCK Clock LOW to TDO Invalid	0	–	ns
Setup Times				
t_{TMSS}	TMS Setup to TCK Clock Rise	5	–	ns
t_{TDIS}	TDI Setup to TCK Clock Rise	5	–	ns
t_{CS}	Capture Setup to TCK Rise	5	–	ns
Hold Times				
t_{TMSH}	TMS Hold after TCK Clock Rise	5	–	ns
t_{TDIH}	TDI Hold after Clock Rise	5	–	ns
t_{CH}	Capture Hold after Clock Rise	5	–	ns

2.5 V TAP AC Test Conditions

Input pulse levels V_{SS} to 2.5 V
 Input rise and fall time 1 ns
 Input timing reference levels 1.25 V
 Output reference levels 1.25 V
 Test load termination supply voltage 1.25 V

2.5 V TAP AC Output Load Equivalent

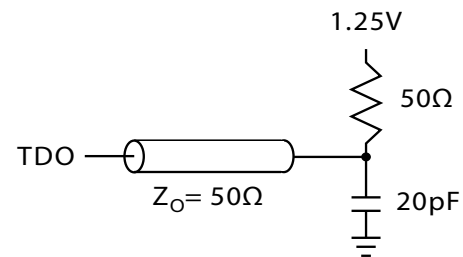

TAP DC Electrical Characteristics and Operating Conditions

(0 °C < T_A < +70 °C; $V_{DD} = 2.5 \text{ V} \pm 0.125 \text{ V}$ unless otherwise noted)

Parameter ^[14]	Description	Test Conditions	Min	Max	Unit
V_{OH1}	Output HIGH Voltage	$I_{OH} = -1.0 \text{ mA}$, $V_{DDQ} = 2.5 \text{ V}$	1.7	–	V
V_{OH2}	Output HIGH Voltage	$I_{OH} = -100 \mu\text{A}$, $V_{DDQ} = 2.5 \text{ V}$	2.1	–	V
V_{OL1}	Output LOW Voltage	$I_{OL} = 1.0 \text{ mA}$, $V_{DDQ} = 2.5 \text{ V}$	–	0.4	V
V_{OL2}	Output LOW Voltage	$I_{OL} = 100 \mu\text{A}$, $V_{DDQ} = 2.5 \text{ V}$	–	0.2	V
V_{IH}	Input HIGH Voltage	$V_{DDQ} = 2.5 \text{ V}$	1.7	$V_{DD} + 0.3$	V
V_{IL}	Input LOW Voltage	$V_{DDQ} = 2.5 \text{ V}$	-0.3	0.7	V
I_X	Input Load Current	$GND \leq V_I \leq V_{DDQ}$	-5	5	μA

Notes

12. t_{CS} and t_{CH} refer to the setup and hold time requirements of latching data from the boundary scan register.
13. Test conditions are specified using the load in TAP AC Test Conditions. $t_P/t_F = 1 \text{ ns}$.
14. All voltages refer to V_{SS} (GND).

Identification Register Definitions

Instruction Field	CY7C1470BV25 (2 M × 36)	Description
Revision Number (31:29)	000	Describes the version number
Device Depth (28:24)	01011	Reserved for internal use
Architecture/Memory Type (23:18)	001000	Defines memory type and architecture
Bus Width/Density (17:12)	100100	Defines width and density
Cypress JEDEC ID Code (11:1)	00000110100	Allows unique identification of SRAM vendor
ID Register Presence Indicator (0)	1	Indicates the presence of an ID register

Scan Register Sizes

Register Name	Bit Size (× 36)
Instruction	3
Bypass	1
ID	32
Boundary Scan Order – 165-ball FBGA	71

Identification Codes

Instruction	Code	Description
EXTEST	000	Captures I/O ring contents. Places the boundary scan register between TDI and TDO. Forces all SRAM outputs to High Z state. This instruction is not 1149.1-compliant.
IDCODE	001	Loads the ID register with the vendor ID code and places the register between TDI and TDO. This operation does not affect SRAM operations.
SAMPLE Z	010	Captures I/O ring contents. Places the boundary scan register between TDI and TDO. Forces all SRAM output drivers to a High Z state.
RESERVED	011	Do Not Use: This instruction is reserved for future use.
SAMPLE/PRELOAD	100	Captures I/O ring contents. Places the boundary scan register between TDI and TDO. Does not affect SRAM operation. This instruction does not implement 1149.1 preload function and is therefore not 1149.1 compliant.
RESERVED	101	Do Not Use: This instruction is reserved for future use.
RESERVED	110	Do Not Use: This instruction is reserved for future use.
BYPASS	111	Places the bypass register between TDI and TDO. This operation does not affect SRAM operations.

Boundary Scan Exit Order

(2 M × 36)

Bit #	165-ball ID
1	C1
2	D1
3	E1
4	D2
5	E2
6	F1
7	G1
8	F2
9	G2
10	J1
11	K1
12	L1
13	J2
14	M1
15	N1
16	K2
17	L2
18	M2
19	R1
20	R2

Bit #	165-ball ID
21	R3
22	P2
23	R4
24	P6
25	R6
26	R8
27	P3
28	P4
29	P8
30	P9
31	P10
32	R9
33	R10
34	R11
35	N11
36	M11
37	L11
38	M10
39	L10
40	K11

Bit #	165-ball ID
41	J11
42	K10
43	J10
44	H11
45	G11
46	F11
47	E11
48	D10
49	D11
50	C11
51	G10
52	F10
53	E10
54	A9
55	B9
56	A10
57	B10
58	A8
59	B8
60	A7

Bit #	165-ball ID
61	B7
62	B6
63	A6
64	B5
65	A5
66	A4
67	B4
68	B3
69	A3
70	A2
71	B2

Maximum Ratings

Exceeding maximum ratings may impair the useful life of the device. These user guidelines are not tested.

Storage Temperature -65 °C to +150 °C

Ambient Temperature with Power Applied -55 °C to +125 °C

Supply Voltage on V_{DD} Relative to GND -0.5 V to +3.6 V

Supply Voltage on V_{DDQ} Relative to GND -0.5 V to +V_{DD}

DC to Outputs in Tri-State -0.5 V to V_{DDQ} + 0.5 V

DC Input Voltage -0.5 V to V_{DD} + 0.5 V

Current into Outputs (LOW) 20 mA

Static Discharge Voltage (MIL-STD-883, Method 3015) > 2001 V

Latch up Current > 200 mA

Operating Range

Range	Ambient Temperature	V _{DD}	V _{DDQ}
Commercial	0 °C to +70 °C	2.5 V – 5% / +5%	2.5 V – 5% to V _{DD}
Industrial	-40 °C to +85 °C		

Electrical Characteristics

Over the Operating Range

Parameter ^[15, 16]	Description	Test Conditions	Min	Max	Unit	
V _{DD}	Power Supply Voltage		2.375	2.625	V	
V _{DDQ}	I/O Supply Voltage	For 2.5 V I/O	2.375	V _{DD}	V	
V _{OH}	Output HIGH Voltage	For 2.5 V I/O, I _{OH} = -1.0 mA	2.0	-	V	
V _{OL}	Output LOW Voltage	For 2.5 V I/O, I _{OL} = 1.0 mA	-	0.4	V	
V _{IH}	Input HIGH Voltage ^[15]	For 2.5 V I/O	1.7	V _{DD} + 0.3	V	
V _{IL}	Input LOW Voltage ^[15]	For 2.5 V I/O	-0.3	0.7	V	
I _X	Input Leakage Current except ZZ and MODE	GND ≤ V _I ≤ V _{DDQ}	-5	5	μA	
		Input = V _{SS}	-30	-	μA	
		Input = V _{DD}	-	5	μA	
		Input Current of ZZ	Input = V _{SS}	-5	-	μA
		Input = V _{DD}	-	30	μA	
I _{OZ}	Output Leakage Current	GND ≤ V _I ≤ V _{DDQ} , Output Disabled	-5	5	μA	
I _{DD} ^[17]	V _{DD} Operating Supply	V _{DD} = Max, I _{OUT} = 0 mA, f = f _{MAX} = 1/t _{CYC}	4.0 ns cycle, 250 MHz	-	450	mA
			5.0 ns cycle, 200 MHz	-	450	mA
			6.0 ns cycle, 167 MHz	-	400	mA
I _{SB1}	Automatic CE Power Down Current – TTL Inputs	Max. V _{DD} , Device Deselected, V _{IN} ≥ V _{IH} or V _{IN} ≤ V _{IL} , f = f _{MAX} = 1/t _{CYC}	4.0 ns cycle, 250MHz	-	200	mA
			5.0 ns cycle, 200 MHz	-	200	mA
			6.0 ns cycle, 167 MHz	-	200	mA
I _{SB2}	Automatic CE Power Down Current – CMOS Inputs	Max. V _{DD} , Device Deselected, V _{IN} ≤ 0.3 V or V _{IN} ≥ V _{DDQ} - 0.3 V, f = 0	All speed grades	-	120	mA

Notes

15. Overshoot: V_{IH(AC)} < V_{DD} + 1.5 V (pulse width less than t_{CYC}/2). Undershoot: V_{IL(AC)} > -2 V (pulse width less than t_{CYC}/2).

16. T_{Power-up}: assumes a linear ramp from 0 V to V_{DD(min)} within 200 ms. During this time V_{IH} < V_{DD} and V_{DDQ} ≤ V_{DD}.

17. The operation current is calculated with 50% read cycle and 50% write cycle.

Electrical Characteristics (continued)

Over the Operating Range

Parameter ^[15, 16]	Description	Test Conditions	Min	Max	Unit	
I _{SB3}	Automatic CE Power Down Current – CMOS Inputs	Max. V _{DD} , Device Deselected, V _{IN} ≤ 0.3 V or V _{IN} ≥ V _{DDQ} – 0.3 V, f = f _{MAX} = 1/t _{CYC}	4.0 ns cycle, 250 MHz	–	200	mA
			5.0 ns cycle, 200 MHz	–	200	mA
			6.0 ns cycle, 167 MHz	–	200	mA
I _{SB4}	Automatic CE Power Down Current – TTL Inputs	Max. V _{DD} , Device Deselected, V _{IN} ≥ V _{IH} or V _{IN} ≤ V _{IL} , f = 0	All speed grades	–	135	mA

Capacitance

Parameter ^[18]	Description	Test Conditions	100-pin TQFP Max	165-ball FBGA Max	Unit
C _{ADDRESS}	Address input capacitance	T _A = 25 °C, f = 1 MHz, V _{DD} = 2.5 V, V _{DDQ} = 2.5 V	6	6	pF
C _{DATA}	Data input capacitance		5	5	pF
C _{CTRL}	Control input capacitance		8	8	pF
C _{CLK}	Clock input capacitance		6	6	pF
C _{IO}	Input/Output capacitance		5	5	pF

Thermal Resistance

Parameter ^[18]	Description	Test Conditions	100-pin TQFP Package	165-ball FBGA Package	Unit
Θ _{JA}	Thermal resistance (junction to ambient)	Test conditions follow standard test methods and procedures for measuring thermal impedance, per EIA/JESD51.	24.63	16.3	°C/W
Θ _{JC}	Thermal resistance (junction to case)		2.28	2.1	°C/W

AC Test Loads and Waveforms

Figure 4. AC Test Loads and Waveforms

2.5 V I/O Test Load

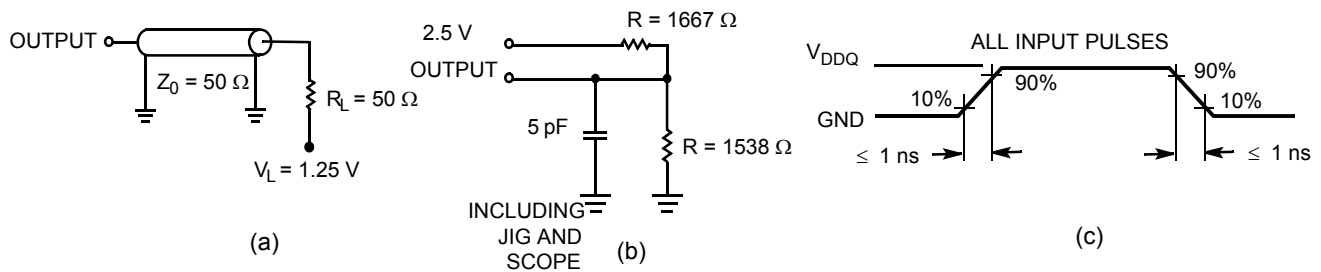

Note

18. Tested initially and after any design or process changes that may affect these parameters.

Switching Characteristics

Over the Operating Range

Parameter ^[19, 20]	Description	250 MHz		200 MHz		167 MHz		Unit
		Min	Max	Min	Max	Min	Max	
$t_{Power}^{[21]}$	V_{CC} (typical) to the first access Read or Write	1	–	1	–	1	–	ms
Clock								
t_{CYC}	Clock cycle time	4.0	–	5.0	–	6.0	–	ns
F_{MAX}	Maximum operating frequency	–	250	–	200	–	167	MHz
t_{CH}	Clock HIGH	2.0	–	2.0	–	2.2	–	ns
t_{CL}	Clock LOW	2.0	–	2.0	–	2.2	–	ns
Output Times								
t_{CO}	Data output valid after CLK rise	–	3.0	–	3.0	–	3.4	ns
t_{OEV}	OE LOW to output valid	–	3.0	–	3.0	–	3.4	ns
t_{DOH}	Data output hold after CLK rise	1.3	–	1.3	–	1.5	–	ns
t_{CHZ}	Clock to high Z ^[22, 23, 24]	–	3.0	–	3.0	–	3.4	ns
t_{CLZ}	Clock to low Z ^[22, 23, 24]	1.3	–	1.3	–	1.5	–	ns
t_{EOHZ}	OE HIGH to output high Z ^[22, 23, 24]	–	3.0	–	3.0	–	3.4	ns
t_{EOLZ}	OE LOW to output low Z ^[22, 23, 24]	0	–	0	–	0	–	ns
Setup Times								
t_{AS}	Address setup before CLK rise	1.4	–	1.4	–	1.5	–	ns
t_{DS}	Data input setup before CLK rise	1.4	–	1.4	–	1.5	–	ns
t_{CENS}	CEN setup before CLK rise	1.4	–	1.4	–	1.5	–	ns
t_{WES}	WE, BW_x setup before CLK rise	1.4	–	1.4	–	1.5	–	ns
t_{ALS}	ADV/LD setup before CLK Rise	1.4	–	1.4	–	1.5	–	ns
t_{CES}	Chip select setup	1.4	–	1.4	–	1.5	–	ns
Hold Times								
t_{AH}	Address hold after CLK rise	0.4	–	0.4	–	0.5	–	ns
t_{DH}	Data input hold after CLK rise	0.4	–	0.4	–	0.5	–	ns
t_{CENH}	CEN hold after CLK rise	0.4	–	0.4	–	0.5	–	ns
t_{WEH}	WE, BW_x hold after CLK rise	0.4	–	0.4	–	0.5	–	ns
t_{ALH}	ADV/LD hold after CLK rise	0.4	–	0.4	–	0.5	–	ns
t_{CEH}	Chip Select hold after CLK rise	0.4	–	0.4	–	0.5	–	ns

Notes

19. Timing reference is 1.25 V when $V_{DDQ} = 2.5$ V.

20. Test conditions shown in (a) of [Figure 4 on page 19](#) unless otherwise noted.

21. This part has a voltage regulator internally; t_{Power} is the time power is supplied above $V_{DD(minimum)}$ initially, before a read or write operation can be initiated.

22. t_{CHZ} , t_{CLZ} , t_{EOLZ} , and t_{EOHZ} are specified with AC test conditions shown in (b) of [Figure 4 on page 19](#). Transition is measured ± 200 mV from steady-state voltage.

23. At any supplied voltage and temperature, t_{EOHZ} is less than t_{EOLZ} and t_{CHZ} is less than t_{CLZ} to eliminate bus contention between SRAMs when sharing the same data bus. These specifications do not imply a bus contention condition, but reflect parameters guaranteed over worst case user conditions. Device is designed to achieve High Z before Low Z under the same system conditions.

24. This parameter is sampled and not 100% tested.

Switching Waveforms

Figure 5. Read/Write Timing [25, 26, 27]

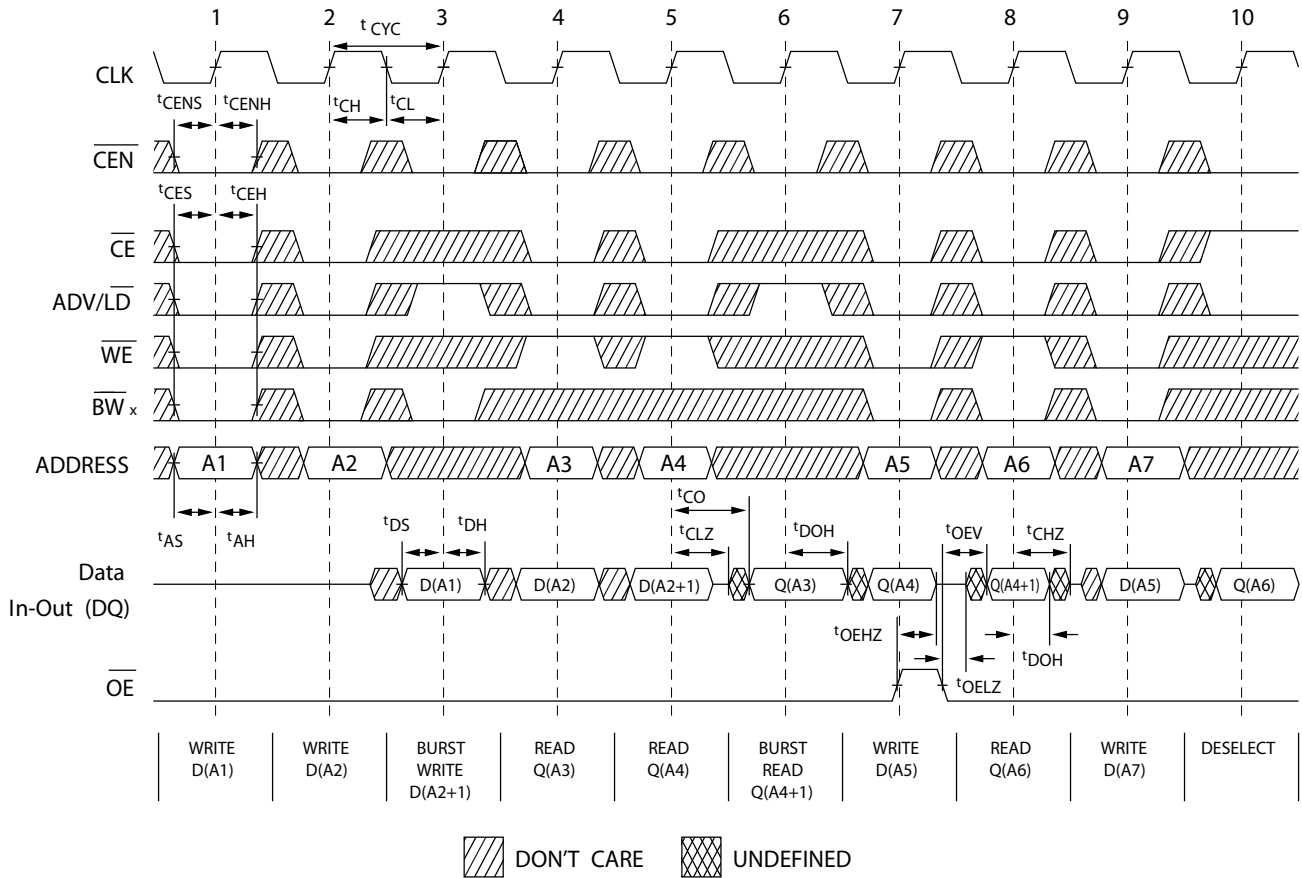

Notes

25. For this waveform \overline{ZZ} is tied LOW.

26. When \overline{CE} is LOW, \overline{CE}_1 is LOW, \overline{CE}_2 is HIGH, and \overline{CE}_3 is LOW. When \overline{CE} is HIGH, \overline{CE}_1 is HIGH, \overline{CE}_2 is LOW, or \overline{CE}_3 is HIGH.

27. Order of the Burst sequence is determined by the status of the MODE (0 = Linear, 1 = Interleaved). Burst operations are optional.

Switching Waveforms (continued)

Figure 6. NOP, STALL and DESELECT Cycles [28, 29, 30]

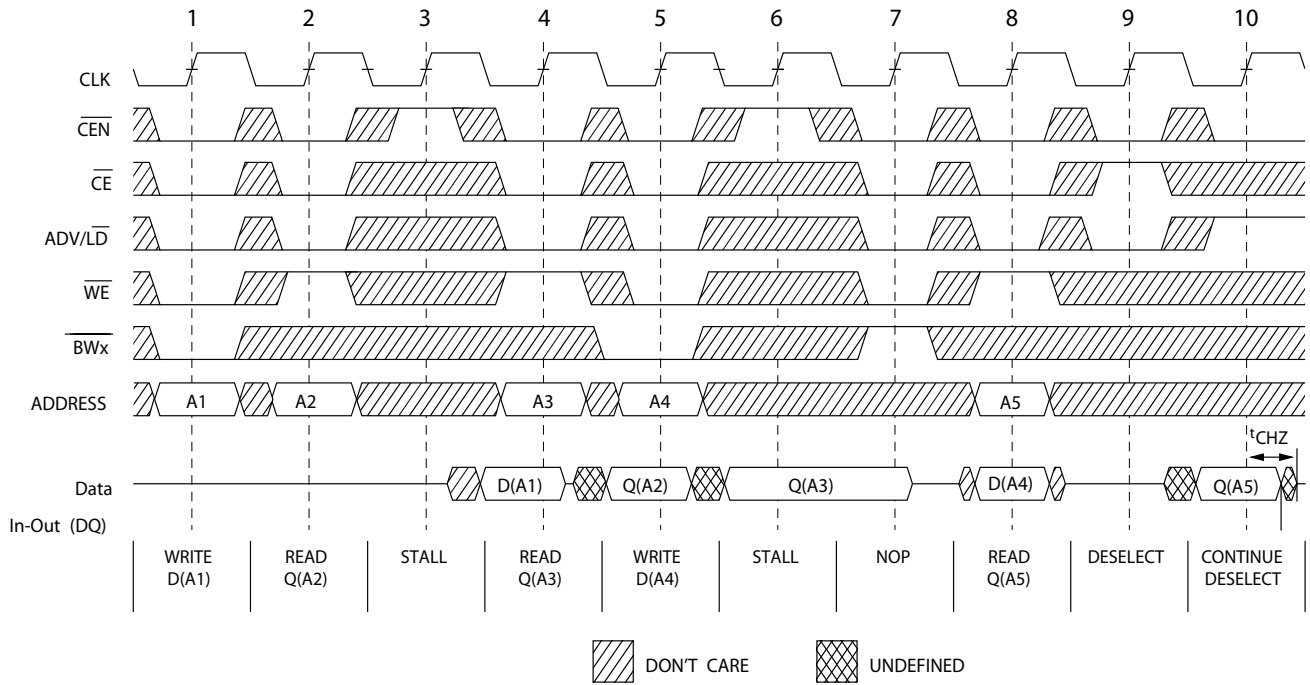
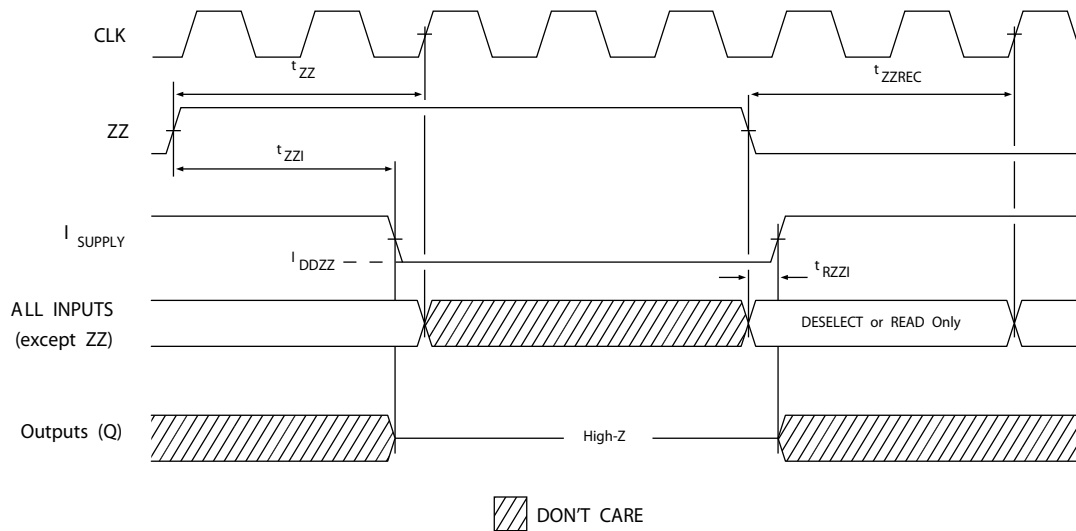

Figure 7. ZZ Mode Timing [31, 32]



Notes

- 28. For this waveform ZZ is tied LOW.
- 29. When \overline{CE} is LOW, \overline{CE}_1 is LOW, CE_2 is HIGH, and \overline{CE}_3 is LOW. When \overline{CE} is HIGH, \overline{CE}_1 is HIGH, CE_2 is LOW, or \overline{CE}_3 is HIGH.
- 30. The IGNORE CLOCK EDGE or STALL cycle (Clock 3) illustrated \overline{CEN} being used to create a pause. A write is not performed during this cycle.
- 31. Device must be deselected when entering ZZ mode. See [Truth Table on page 9](#) for all possible signal conditions to deselect the device.
- 32. IOs are in High Z when exiting ZZ sleep mode.

Ordering Information

Cypress offers other versions of this type of product in many different configurations and features. The below table contains only the list of parts that are currently available. For a complete listing of all options, visit the Cypress website at www.cypress.com and refer to the product summary page at <http://www.cypress.com/products> or contact your local sales representative. Cypress maintains a worldwide network of offices, solution centers, manufacturer's representatives and distributors. To find the office closest to you, visit us at <http://www.cypress.com/go/datasheet/offices>.

Speed (MHz)	Ordering Code	Package Diagram	Part and Package Type	Operating Range
167	CY7C1470BV25-167AXC	51-85050	100-pin TQFP (14 × 20 × 1.4 mm) Pb-free	Commercial
	CY7C1470BV25-167BZXI	51-85165	165-ball FBGA (15 × 17 × 1.4 mm) Pb-free	Industrial
200	CY7C1470BV25-200AXC	51-85050	100-pin TQFP (14 × 20 × 1.4 mm) Pb-free	Commercial
	CY7C1472BV25-200AXC			Industrial
	CY7C1470BV25-200AXI			
	CY7C1470BV25-200BZXI	51-85165	165-ball FBGA (15 × 17 × 1.4 mm) Pb-free	Industrial
250	CY7C1470BV25-250AXC	51-85050	100-pin TQFP (14 × 20 × 1.4 mm) Pb-free	Commercial
	CY7C1470BV25-250BZXC	51-85165	165-ball FBGA (15 × 17 × 1.4 mm) Pb-free	Industrial
	CY7C1470BV25-250AXI	51-85050	100-pin TQFP (14 × 20 × 1.4 mm) Pb-free	

Ordering Code Definitions

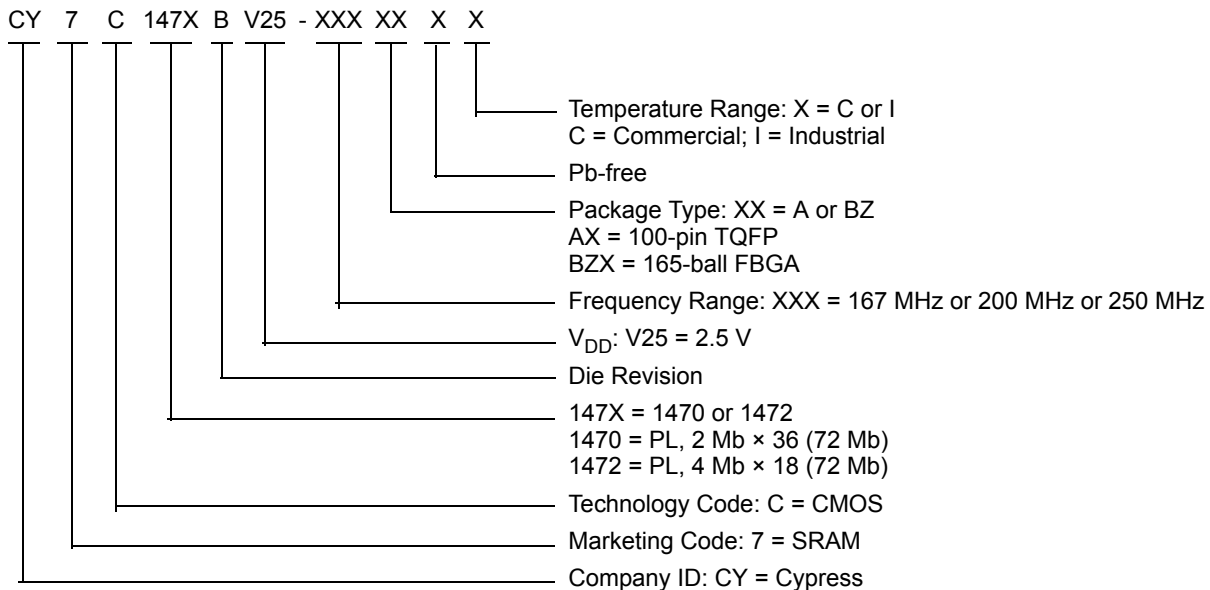

Package Diagrams

Figure 8. 100-pin TQFP (14 × 20 × 1.4 mm) A100RA Package Outline, 51-85050

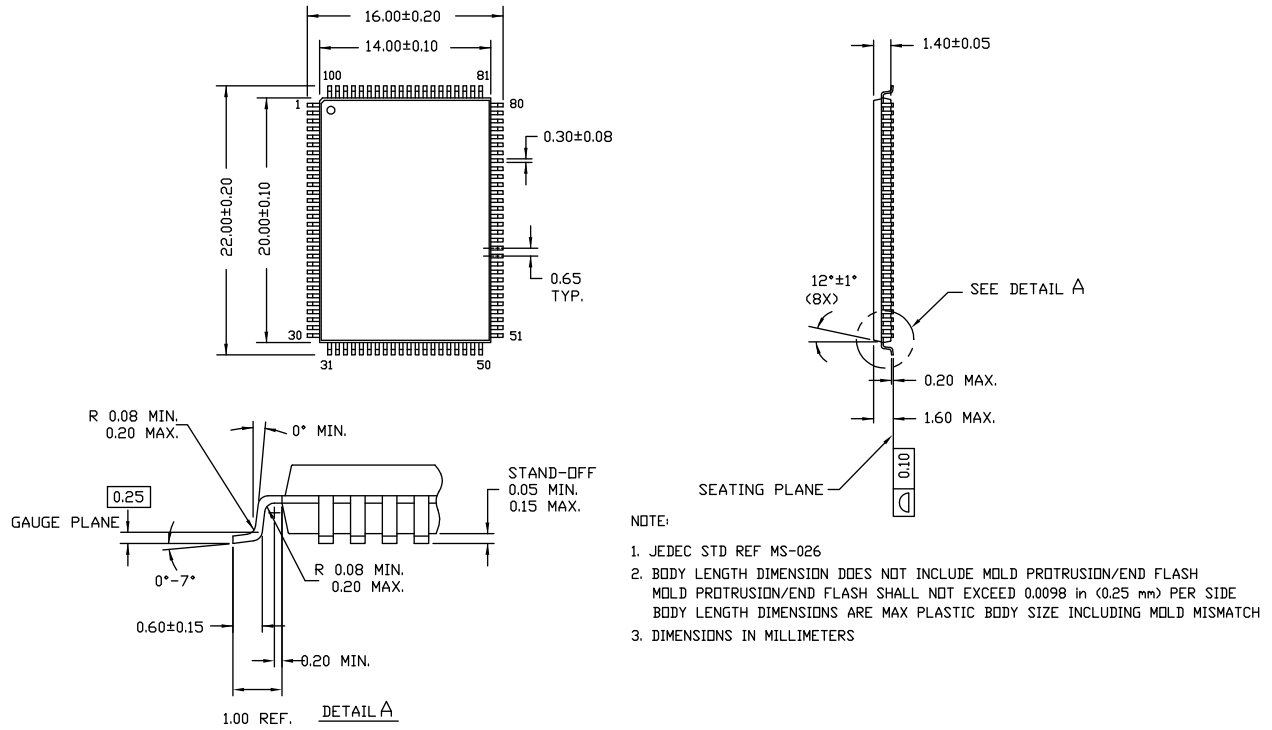

51-85050 *D

Package Diagrams (continued)

Figure 9. 165-ball FBGA (15 × 17 × 1.4 mm) (0.45 Ball Diameter) Package Outline, 51-85165

NOTES:
 SOLDER PAD TYPE: SOLDER MASK DEFINED (SMD)
 PACKAGE WEIGHT: 0.60g
 JEDEC REFERENCE: MO-216 / ISSUE E
 PACKAGE CODES: BB0AA / BW0AG

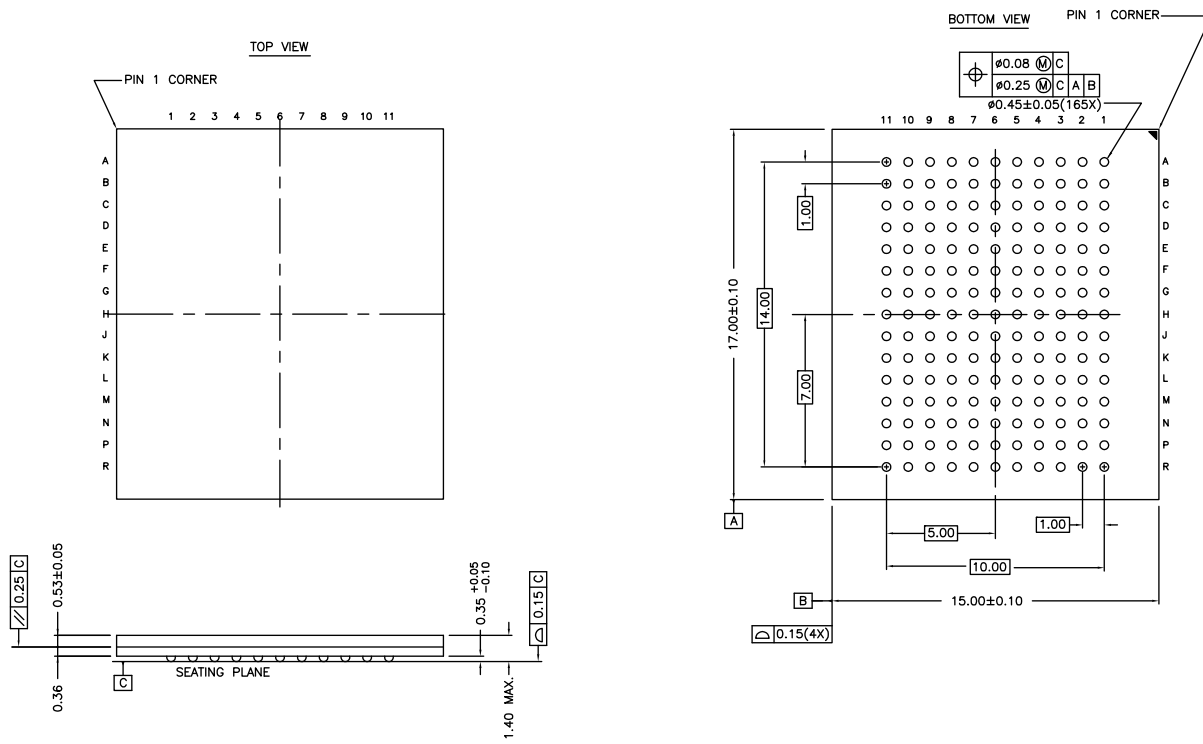

51-85165 *D

Acronyms

Acronym	Description
BGA	Ball Grid Array
CMOS	Complementary Metal Oxide Semiconductor
EIA	Electronic Industries Alliance
FBGA	Fine-Pitch Ball Grid Array
I/O	Input/Output
JEDEC	Joint Electron Devices Engineering Council
JTAG	Joint Test Action Group
LSB	Least Significant Bit
MSB	Most Significant Bit
OE	Output Enable
SRAM	Static Random Access Memory
TAP	Test Access Port
TCK	Test Clock
TDI	Test Data-In
TDO	Test Data-Out
TMS	Test Mode Select
TQFP	Thin Quad Flat Pack
TTL	Transistor-Transistor Logic
WE	Write Enable

Document Conventions

Units of Measure

Symbol	Unit of Measure
°C	degree Celsius
μA	microampere
mA	milliampere
mm	millimeter
ms	millisecond
MHz	megahertz
ns	nanosecond
Ω	ohm
%	percent
pF	picofarad
V	volt
W	watt

Document History Page

Document Title: CY7C1470BV25/CY7C1472BV25, 72-Mbit (2 M × 36/4 M × 18) Pipelined SRAM with NoBL™ Architecture				
Document Number: 001-15032				
Rev.	ECN No.	Issue Date	Orig. of Change	Description of Change
**	1032642	See ECN	VKN / KKVTMP	New data sheet.
*A	1562503	See ECN	VKN / AESA	Updated Features (Removed 1.8 V I/O supply information). Updated IEEE 1149.1 Serial Boundary Scan (JTAG) (Removed 1.8 V I/O supply information). Removed the section "1.8 V TAP AC Test Conditions". Removed the section "1.8 V TAP AC Output Load Equivalent". Updated TAP DC Electrical Characteristics and Operating Conditions (Removed 1.8 V I/O supply information). Updated Electrical Characteristics (Removed 1.8 V I/O supply information). Updated AC Test Loads and Waveforms (Removed 1.8 V I/O supply information). Updated Switching Characteristics (Removed 1.8 V I/O supply information).
*B	1897447	See ECN	VKN / AESA	Updated Electrical Characteristics (Added Note 17 and referred the same note in I _{DD} parameter).
*C	2082487	See ECN	VKN	Changed status from Preliminary to Final.
*D	2159486	See ECN	VKN / PYRS	Minor Change (Moved to the external web).
*E	2898663	03/24/2010	NJY	Updated Ordering Information (Removed inactive parts from Ordering Information table). Updated Package Diagrams .
*F	2905460	04/06/2010	VKN	Updated Ordering Information (Removed inactive part numbers CY7C1470BV25-167BZC, CY7C1470BV25-167BZI, CY7C1470BV25-167BZXC, CY7C1470BV25-200BZC, CY7C1472BV25-250BZC, CY7C1474BV25-167BGC, CY7C1474BV25-167BGI, CY7C1474BV25-200BGC, CY7C1474BV25-200BGI, CY7C1474BV25-200BGXI from the ordering information table).
*G	3061663	10/15/2010	NJY	Updated Ordering Information (Removed pruned parts CY7C1472BV25-200BZI, CY7C1472BV25-200BZIT from the ordering information table) and added Ordering Code Definitions . Updated Package Diagrams .
*H	3207526	03/28/2011	NJY	Updated Ordering Information (updated part numbers). Updated Package Diagrams . Updated in new template.
*I	3257192	05/14/2011	NJY	Updated Ordering Information (updated part numbers). Added Acronyms and Units of Measure .

Document History Page (continued)

Document Title: CY7C1470BV25/CY7C1472BV25, 72-Mbit (2 M × 36/4 M × 18) Pipelined SRAM with NoBL™ Architecture				
Document Number: 001-15032				
Rev.	ECN No.	Issue Date	Orig. of Change	Description of Change
*J	3545503	03/08/2012	PRIT / NJY	<p>Updated Features (Removed CY7C1474BV25 related information). Updated Functional Description (Removed CY7C1474BV25 related information). Removed Logic Block Diagram – CY7C1474BV25. Updated Pin Configurations (Removed CY7C1474BV25 related information). Updated Functional Overview (Removed CY7C1474BV25 related information). Updated Truth Table (Removed CY7C1474BV25 related information). Updated Partial Write Cycle Description (Removed CY7C1474BV25 related information). Updated IEEE 1149.1 Serial Boundary Scan (JTAG) (Removed CY7C1472BV25 and CY7C1474BV25 related information). Updated Identification Register Definitions (Removed CY7C1472BV25 and CY7C1474BV25 related information). Updated Scan Register Sizes (Removed Bit Size (× 18) and Bit Size (× 72) columns). Removed “Boundary Scan Exit Order (4 M × 18)” and “Boundary Scan Exit Order (1 M × 72)”. Updated Capacitance (Removed 209-ball FBGA package related information). Updated Thermal Resistance (Removed 209-ball FBGA package related information). Updated Ordering Information (Updated part numbers). Updated Package Diagrams Replaced IO with I/O in all instances across the document.</p>
*K	3912915	02/25/2013	PRIT	<p>Updated Ordering Information: Added part number CY7C1470BV25-250AXI.</p>

Sales, Solutions, and Legal Information

Worldwide Sales and Design Support

Cypress maintains a worldwide network of offices, solution centers, manufacturer's representatives, and distributors. To find the office closest to you, visit us at [Cypress Locations](#).

Products

Automotive	cypress.com/go/automotive
Clocks & Buffers	cypress.com/go/clocks
Interface	cypress.com/go/interface
Lighting & Power Control	cypress.com/go/powerpsoc cypress.com/go/plc
Memory	cypress.com/go/memory
Optical & Image Sensing	cypress.com/go/image
PSoC	cypress.com/go/psoc
Touch Sensing	cypress.com/go/touch
USB Controllers	cypress.com/go/USB
Wireless/RF	cypress.com/go/wireless

PSoC Solutions

psoc.cypress.com/solutions
PSoC 1 | PSoC 3 | PSoC 5

© Cypress Semiconductor Corporation, 2007-2013. The information contained herein is subject to change without notice. Cypress Semiconductor Corporation assumes no responsibility for the use of any circuitry other than circuitry embodied in a Cypress product. Nor does it convey or imply any license under patent or other rights. Cypress products are not warranted nor intended to be used for medical, life support, life saving, critical control or safety applications, unless pursuant to an express written agreement with Cypress. Furthermore, Cypress does not authorize its products for use as critical components in life-support systems where a malfunction or failure may reasonably be expected to result in significant injury to the user. The inclusion of Cypress products in life-support systems application implies that the manufacturer assumes all risk of such use and in doing so indemnifies Cypress against all charges.

Any Source Code (software and/or firmware) is owned by Cypress Semiconductor Corporation (Cypress) and is protected by and subject to worldwide patent protection (United States and foreign), United States copyright laws and international treaty provisions. Cypress hereby grants to licensee a personal, non-exclusive, non-transferable license to copy, use, modify, create derivative works of, and compile the Cypress Source Code and derivative works for the sole purpose of creating custom software and or firmware in support of licensee product to be used only in conjunction with a Cypress integrated circuit as specified in the applicable agreement. Any reproduction, modification, translation, compilation, or representation of this Source Code except as specified above is prohibited without the express written permission of Cypress.

Disclaimer: CYPRESS MAKES NO WARRANTY OF ANY KIND, EXPRESS OR IMPLIED, WITH REGARD TO THIS MATERIAL, INCLUDING, BUT NOT LIMITED TO, THE IMPLIED WARRANTIES OF MERCHANTABILITY AND FITNESS FOR A PARTICULAR PURPOSE. Cypress reserves the right to make changes without further notice to the materials described herein. Cypress does not assume any liability arising out of the application or use of any product or circuit described herein. Cypress does not authorize its products for use as critical components in life-support systems where a malfunction or failure may reasonably be expected to result in significant injury to the user. The inclusion of Cypress' product in a life-support systems application implies that the manufacturer assumes all risk of such use and in doing so indemnifies Cypress against all charges.

Use may be limited by and subject to the applicable Cypress software license agreement.