

**High-Speed CMOS Logic 3- to 8-Line Decoder/  
Demultiplexer Inverting and Noninverting**
**Features**

- **Select One Of Eight Data Outputs**  
Active Low for 138, Active High for 238
- **I/O Port or Memory Selector**
- **Three Enable Inputs to Simplify Cascading**
- **Typical Propagation Delay of 13 ns at  $V_{CC} = 5\text{ V}$ ,  
 $C_L = 15\text{ pF}$ ,  $T_A = 25^\circ\text{C}$**
- **Fanout (Over Temperature Range)**
  - **Standard Outputs . . . . . 10 LSTTL Loads**
  - **Bus Driver Outputs . . . . . 15 LSTTL Loads**
- **Wide Operating Temperature Range . . .  $-55^\circ\text{C}$  to  $125^\circ\text{C}$**
- **Balanced Propagation Delay and Transition Times**
- **Significant Power Reduction Compared to LSTTL  
Logic ICs**
- **HC Types**
  - **2 V to 6 V Operation**
  - **High Noise Immunity:  $N_{IL} = 30\%$ ,  $N_{IH} = 30\%$  of  $V_{CC}$   
at  $V_{CC} = 5\text{ V}$**
- **HCT Types**
  - **4.5-V to 5.5-V Operation**
  - **Direct LSTTL Input Logic Compatibility,  
 $V_{IL} = 0.8\text{ V (Max)}$ ,  $V_{IH} = 2\text{ V (Min)}$**
  - **CMOS Input Compatibility,  $I_I \leq 1\mu\text{A}$  at  $V_{OL}$ ,  $V_{OH}$**

**Description**

The 'HC138, 'HC238, 'HCT138, and 'HCT238 are high-speed silicon-gate CMOS decoders well suited to memory address decoding or data-routing applications. Both circuits feature low power consumption usually associated with CMOS circuitry, yet have speeds comparable to low-power Schottky TTL logic. Both circuits have three binary select inputs (A0, A1, and A2). If the device is enabled, these inputs determine which one of the eight normally high outputs of the HC/HCT138 series go low or which of the normally low outputs of the HC/HCT238 series go high.

Two active low and one active high enables ( $\overline{E1}$ ,  $\overline{E2}$ , and E3) are provided to ease the cascading of decoders. The decoder's eight outputs can drive ten low-power Schottky TTL equivalent loads.

**Ordering Information**

PART NUMBER	TEMP. RANGE (°C)	PACKAGE
CD54HC138F3A	-55 to 125	16 Ld CERDIP
CD54HC238F3A	-55 to 125	16 Ld CERDIP
CD54HCT138F3A	-55 to 125	16 Ld CERDIP
CD54HCT238F3A	-55 to 125	16 Ld CERDIP
CD74HC138E	-55 to 125	16 Ld PDIP
CD74HC138M	-55 to 125	16 Ld SOIC
CD74HC138MT	-55 to 125	16 Ld SOIC
CD74HC138M96	-55 to 125	16 Ld SOIC
CD74HC238E	-55 to 125	16 Ld PDIP
CD74HC238M	-55 to 125	16 Ld SOIC
CD74HC238MT	-55 to 125	16 Ld SOIC
CD74HC238M96	-55 to 125	16 Ld SOIC
CD74HC238NSR	-55 to 125	16 Ld SOP
CD74HC238PW	-55 to 125	16 Ld TSSOP
CD74HC238PWR	-55 to 125	16 Ld TSSOP
CD74HC238PWT	-55 to 125	16 Ld TSSOP
CD74HCT138E	-55 to 125	16 Ld PDIP
CD74HCT138M	-55 to 125	16 Ld SOIC
CD74HCT138MT	-55 to 125	16 Ld SOIC
CD74HCT138M96	-55 to 125	16 Ld SOIC
CD74HCT238E	-55 to 125	16 Ld PDIP
CD74HCT238M	-55 to 125	16 Ld SOIC
CD74HCT238M96	-55 to 125	16 Ld SOIC

NOTE: When ordering, use the entire part number. The suffixes 96 and R denote tape and reel. The suffix T denotes a small-quantity reel of 250.

# CD54/74HC138, CD54/74HCT138, CD54/74HC238, CD54/74HCT238

## Pinout

CD54HC138, CD54HCT138, CD54HC238, CD54HCT238  
(CERDIP)  
CD74HC138, CD74HCT138, CD74HCT238  
(PDIP, SOIC)  
CD74HC238  
(PDIP, SOIC, SOP, TSSOP)  
TOP VIEW

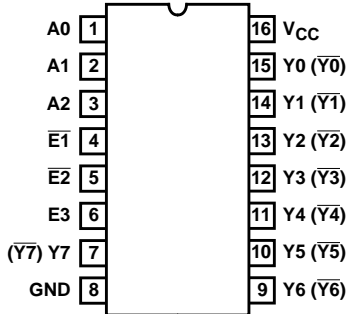

## Functional Diagram

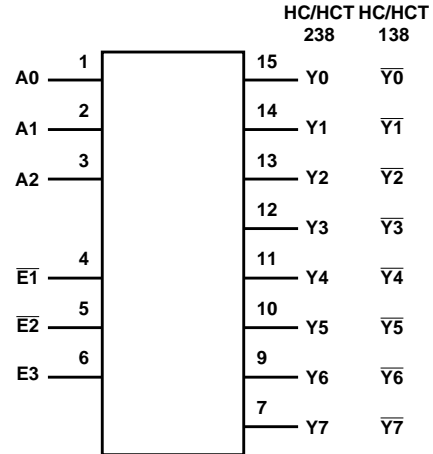

Signal names in parentheses are for 'HC138 and 'HCT138.

TRUTH TABLE 'HC138, 'HCT138

INPUTS						OUTPUTS							
ENABLE			ADDRESS										
E3	E2	E1	A2	A1	A0	Y0	Y1	Y2	Y3	Y4	Y5	Y6	Y7
X	X	H	X	X	X	H	H	H	H	H	H	H	H
L	X	X	X	X	X	H	H	H	H	H	H	H	H
X	H	X	X	X	X	H	H	H	H	H	H	H	H
H	L	L	L	L	L	L	H	H	H	H	H	H	H
H	L	L	L	L	H	H	L	H	H	H	H	H	H
H	L	L	L	H	L	H	H	L	H	H	H	H	H
H	L	L	L	H	H	H	H	H	L	H	H	H	H
H	L	L	H	L	L	H	H	H	H	L	H	H	H
H	L	L	H	H	L	H	H	H	H	H	L	H	H
H	L	L	H	H	H	H	H	H	H	H	H	H	L

H = High Voltage Level, L = Low Voltage Level, X = Don't Care

TRUTH TABLE 'HC238, 'HCT238

INPUTS						OUTPUTS							
ENABLE			ADDRESS										
E3	E2	E1	A2	A1	A0	Y0	Y1	Y2	Y3	Y4	Y5	Y6	Y7
X	X	H	X	X	X	L	L	L	L	L	L	L	L
L	X	X	X	X	X	L	L	L	L	L	L	L	L
X	H	X	X	X	X	L	L	L	L	L	L	L	L
H	L	L	L	L	L	H	L	L	L	L	L	L	L
H	L	L	L	L	H	L	H	L	L	L	L	L	L
H	L	L	L	H	L	L	L	H	L	L	L	L	L
H	L	L	L	H	H	L	L	L	H	L	L	L	L
H	L	L	H	L	L	L	L	L	L	H	L	L	L
H	L	L	H	L	H	L	L	L	L	L	H	L	L
H	L	L	H	H	L	L	L	L	L	L	L	H	L
H	L	L	H	H	H	L	L	L	L	L	L	L	H

H = High Voltage Level, L = Low Voltage Level, X = Don't Care

# CD54/74HC138, CD54/74HCT138, CD54/74HC238, CD54/74HCT238

## Absolute Maximum Ratings

DC Supply Voltage,  $V_{CC}$  ..... -0.5V to 7V  
 DC Input Diode Current,  $I_{IK}$   
 For  $V_I < -0.5V$  or  $V_I > V_{CC} + 0.5V$  .....  $\pm 20mA$   
 DC Output Diode Current,  $I_{OK}$   
 For  $V_O < -0.5V$  or  $V_O > V_{CC} + 0.5V$  .....  $\pm 20mA$   
 DC Output Source or Sink Current per Output Pin,  $I_O$   
 For  $V_O > -0.5V$  or  $V_O < V_{CC} + 0.5V$  .....  $\pm 25mA$   
 DC  $V_{CC}$  or Ground Current,  $I_{CC}$  or  $I_{GND}$  .....  $\pm 50mA$

## Thermal Information

Package Thermal Impedance,  $\theta_{JA}$  (see Note 1):  
 E (PDIP) Package .....  $67^{\circ}C/W$   
 M (SOIC) Package .....  $73^{\circ}C/W$   
 NS (SOP) Package .....  $64^{\circ}C/W$   
 PW (TSSOP) Package .....  $108^{\circ}C/W$   
 Maximum Junction Temperature .....  $150^{\circ}C$   
 Maximum Storage Temperature Range .....  $-65^{\circ}C$  to  $150^{\circ}C$   
 Maximum Lead Temperature (Soldering 10s) .....  $300^{\circ}C$   
 (SOIC - Lead Tips Only)

## Operating Conditions

Temperature Range ( $T_A$ ) .....  $-55^{\circ}C$  to  $125^{\circ}C$   
 Supply Voltage Range,  $V_{CC}$   
 HC Types ..... 2V to 6V  
 HCT Types ..... 4.5V to 5.5V  
 DC Input or Output Voltage,  $V_I, V_O$  ..... 0V to  $V_{CC}$   
 Input Rise and Fall Time  
 2V ..... 1000ns (Max)  
 4.5V ..... 500ns (Max)  
 6V ..... 400ns (Max)

*CAUTION: Stresses above those listed in "Absolute Maximum Ratings" may cause permanent damage to the device. This is a stress only rating, and operation of the device at these or any other conditions above those indicated in the operational sections of this specification is not implied.*

### NOTE:

- The package thermal impedance is calculated in accordance with JESD 51-7.

## DC Electrical Specifications

PARAMETER	SYMBOL	TEST CONDITIONS		$V_{CC}$ (V)	25°C			-40°C TO 85°C		-55°C TO 125°C		UNITS
		$V_I$ (V)	$I_O$ (mA)		MIN	TYP	MAX	MIN	MAX	MIN	MAX	
<b>HC TYPES</b>												
High Level Input Voltage	$V_{IH}$	-	-	2	1.5	-	-	1.5	-	1.5	-	V
				4.5	3.15	-	-	3.15	-	3.15	-	V
				6	4.2	-	-	4.2	-	4.2	-	V
Low Level Input Voltage	$V_{IL}$	-	-	2	-	-	0.5	-	0.5	-	0.5	V
				4.5	-	-	1.35	-	1.35	-	1.35	V
				6	-	-	1.8	-	1.8	-	1.8	V
High Level Output Voltage CMOS Loads	$V_{OH}$	$V_{IH}$ or $V_{IL}$	-0.02	2	1.9	-	-	1.9	-	1.9	-	V
			-0.02	4.5	4.4	-	-	4.4	-	4.4	-	V
			-0.02	6	5.9	-	-	5.9	-	5.9	-	V
High Level Output Voltage TTL Loads	$V_{OH}$	$V_{IH}$ or $V_{IL}$	-	-	-	-	-	-	-	-	-	V
			-4	4.5	3.98	-	-	3.84	-	3.7	-	V
			-5.2	6	5.48	-	-	5.34	-	5.2	-	V
Low Level Output Voltage CMOS Loads	$V_{OL}$	$V_{IH}$ or $V_{IL}$	0.02	2	-	-	0.1	-	0.1	-	0.1	V
			0.02	4.5	-	-	0.1	-	0.1	-	0.1	V
			0.02	6	-	-	0.1	-	0.1	-	0.1	V
Low Level Output Voltage TTL Loads	$V_{OL}$	$V_{IH}$ or $V_{IL}$	-	-	-	-	-	-	-	-	-	V
			4	4.5	-	-	0.26	-	0.33	-	0.4	V
			5.2	6	-	-	0.26	-	0.33	-	0.4	V
Input Leakage Current	$I_I$	$V_{CC}$ or GND	-	6	-	-	$\pm 0.1$	-	$\pm 1$	-	$\pm 1$	$\mu A$
Quiescent Device Current	$I_{CC}$	$V_{CC}$ or GND	0	6	-	-	8	-	80	-	160	$\mu A$

**CD54/74HC138, CD54/74HCT138, CD54/74HC238, CD54/74HCT238**

**DC Electrical Specifications (Continued)**

PARAMETER	SYMBOL	TEST CONDITIONS		V <sub>CC</sub> (V)	25°C			-40°C TO 85°C		-55°C TO 125°C		UNITS
		V <sub>I</sub> (V)	I <sub>O</sub> (mA)		MIN	TYP	MAX	MIN	MAX	MIN	MAX	
<b>HCT TYPES</b>												
High Level Input Voltage	V <sub>IH</sub>	-	-	4.5 to 5.5	2	-	-	2	-	2	-	V
Low Level Input Voltage	V <sub>IL</sub>	-	-	4.5 to 5.5	-	-	0.8	-	0.8	-	0.8	V
High Level Output Voltage CMOS Loads	V <sub>OH</sub>	V <sub>IH</sub> or V <sub>IL</sub>	-0.02	4.5	4.4	-	-	4.4	-	4.4	-	V
High Level Output Voltage TTL Loads			-4	4.5	3.98	-	-	3.84	-	3.7	-	V
Low Level Output Voltage CMOS Loads	V <sub>OL</sub>	V <sub>IH</sub> or V <sub>IL</sub>	0.02	4.5	-	-	0.1	-	0.1	-	0.1	V
Low Level Output Voltage TTL Loads			4	4.5	-	-	0.26	-	0.33	-	0.4	V
Input Leakage Current	I <sub>I</sub>	V <sub>CC</sub> and GND	0	5.5	-	-	±0.1	-	±1	-	±1	μA
Quiescent Device Current	I <sub>CC</sub>	V <sub>CC</sub> or GND	0	5.5	-	-	8	-	80	-	160	μA
Additional Quiescent Device Current Per Input Pin: 1 Unit Load	ΔI <sub>CC</sub> (Note 2)	V <sub>CC</sub> -2.1	-	4.5 to 5.5	-	100	360	-	450	-	490	μA

NOTE:

2. For dual-supply systems, theoretical worst case (V<sub>I</sub> = 2.4V, V<sub>CC</sub> = 5.5V) specification is 1.8mA.

**HCT Input Loading Table**

INPUT	UNIT LOADS
A0-A2	1.5
E1, E2	1.25
E3	1

NOTE: Unit Load is ΔI<sub>CC</sub> limit specified in DC Electrical Table, e.g., 360μA max at 25°C.

**Switching Specifications** Input t<sub>r</sub>, t<sub>f</sub> = 6ns

PARAMETER	SYMBOL	TEST CONDITIONS	V <sub>CC</sub> (V)	25°C			-40°C TO 85°C		-55°C TO 125°C		UNITS
				MIN	TYP	MAX	MIN	MAX	MIN	MAX	
<b>HC TYPES</b>											
Propagation Delay Address to Output	t <sub>PLH</sub> , t <sub>PHL</sub>	C <sub>L</sub> = 50pF	2	-	-	150	-	190	-	225	ns
			4.5	-	-	30	-	38	-	45	ns
		C <sub>L</sub> = 15pF	5	-	13	-	-	-	-	-	ns
			C <sub>L</sub> = 50pF	6	-	-	26	-	33	-	38

**CD54/74HC138, CD54/74HCT138, CD54/74HC238, CD54/74HCT238**

**Switching Specifications** Input  $t_r, t_f = 6\text{ns}$  (Continued)

PARAMETER	SYMBOL	TEST CONDITIONS	$V_{CC}$ (V)	25°C			-40°C TO 85°C		-55°C TO 125°C		UNITS
				MIN	TYP	MAX	MIN	MAX	MIN	MAX	
Enable to Output HC/HCT138	$t_{PLH}, t_{PHL}$	$C_L = 50\text{pF}$	2	-	-	150	-	190	-	265	ns
			4.5	-	-	30	-	38	-	53	ns
			6	-	-	26	-	33	-	45	ns
Output Transition Time (Figure 1)	$t_{TLH}, t_{THL}$	$C_L = 50\text{pF}$	2	-	-	75	-	95	-	110	ns
			4.5	-	-	15	-	19	-	22	ns
			6	-	-	13	-	16	-	19	ns
Power Dissipation Capacitance (Notes 3, 4)	$C_{PD}$	$C_L = 15\text{pF}$	5	-	67	-	-	-	-	-	pF
Input Capacitance	$C_{IN}$	-	-	-	-	10	-	10	-	10	pF
<b>HCT TYPES</b>											
Propagation Delay Address to Output	$t_{PLH}, t_{PHL}$	$C_L = 50\text{pF}$	4.5	-	-	35	-	44	-	53	ns
		$C_L = 15\text{pF}$	5	-	14	-	-	-	-	-	ns
Enable to Output HC/HCT138	$t_{PLH}, t_{PHL}$	$C_L = 50\text{pF}$	4.5	-	-	35	-	44	-	53	ns
Enable to Output HC/HCT238	$t_{PLH}, t_{PHL}$	$C_L = 15\text{pF}$	4.5	-	-	40	-	50	-	60	ns
Output Transition Time (Figure 2)	$t_{TLH}, t_{THL}$	$C_L = 50\text{pF}$	4.5	-	-	15	-	19	-	22	ns
Power Dissipation Capacitance (Notes 3, 4)	$C_{PD}$	$C_L = 15\text{pF}$	5	-	67	-	-	-	-	-	pF
Input Capacitance	$C_{IN}$	-	-	-	-	10	-	10	-	10	pF

**NOTES:**

- $C_{PD}$  is used to determine the dynamic power consumption, per gate.
- $P_D = V_{CC}^2 f_i (C_{PD} + C_L)$  where  $f_i$  = Input Frequency,  $C_L$  = Output Load Capacitance,  $V_{CC}$  = Supply Voltage.

**Test Circuits and Waveforms**

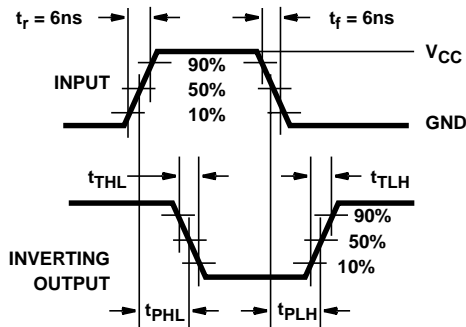

**FIGURE 7. HC AND HCU TRANSITION TIMES AND PROPAGATION DELAY TIMES, COMBINATION LOGIC**

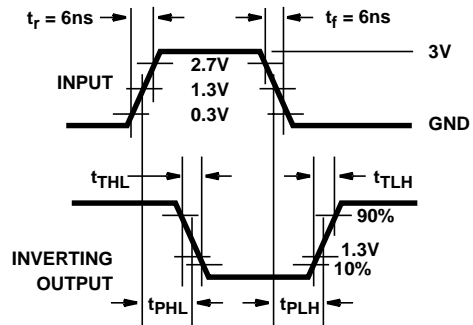

**FIGURE 8. HCT TRANSITION TIMES AND PROPAGATION DELAY TIMES, COMBINATION LOGIC**

**PACKAGING INFORMATION**

Orderable Device	Status (1)	Package Type	Package Drawing	Pins	Package Qty	Eco Plan (2)	Lead/Ball Finish (6)	MSL Peak Temp (3)	Op Temp (°C)	Device Marking (4/5)	Samples
5962-8688401EA	ACTIVE	CDIP	J	16	1	TBD	A42	N / A for Pkg Type	-55 to 125	5962-8688401EA CD54HC238F3A	<a href="#">Samples</a>
CD54HC138F	ACTIVE	CDIP	J	16	1	TBD	A42	N / A for Pkg Type	-55 to 125	CD54HC138F	<a href="#">Samples</a>
CD54HC138F3A	ACTIVE	CDIP	J	16	1	TBD	A42	N / A for Pkg Type	-55 to 125	8406201EA CD54HC138F3A	<a href="#">Samples</a>
CD54HC238F3A	ACTIVE	CDIP	J	16	1	TBD	A42	N / A for Pkg Type	-55 to 125	5962-8688401EA CD54HC238F3A	<a href="#">Samples</a>
CD54HCT138F	ACTIVE	CDIP	J	16	1	TBD	A42	N / A for Pkg Type	-55 to 125	CD54HCT138F	<a href="#">Samples</a>
CD54HCT138F3A	ACTIVE	CDIP	J	16	1	TBD	A42	N / A for Pkg Type	-55 to 125	8550401EA CD54HCT138F3A	<a href="#">Samples</a>
CD54HCT238F3A	ACTIVE	CDIP	J	16	1	TBD	A42	N / A for Pkg Type	-55 to 125	5962-8974501EA CD54HCT238F3A	<a href="#">Samples</a>
CD74HC138E	ACTIVE	PDIP	N	16	25	Pb-Free (RoHS)	CU NIPDAU	N / A for Pkg Type	-55 to 125	CD74HC138E	<a href="#">Samples</a>
CD74HC138EE4	ACTIVE	PDIP	N	16	25	Pb-Free (RoHS)	CU NIPDAU	N / A for Pkg Type	-55 to 125	CD74HC138E	<a href="#">Samples</a>
CD74HC138M	ACTIVE	SOIC	D	16	40	Green (RoHS & no Sb/Br)	CU NIPDAU	Level-1-260C-UNLIM	-55 to 125	HC138M	<a href="#">Samples</a>
CD74HC138M96	ACTIVE	SOIC	D	16	2500	Green (RoHS & no Sb/Br)	CU NIPDAU	Level-1-260C-UNLIM	-55 to 125	HC138M	<a href="#">Samples</a>
CD74HC138M96E4	ACTIVE	SOIC	D	16	2500	Green (RoHS & no Sb/Br)	CU NIPDAU	Level-1-260C-UNLIM	-55 to 125	HC138M	<a href="#">Samples</a>
CD74HC138M96G4	ACTIVE	SOIC	D	16	2500	Green (RoHS & no Sb/Br)	CU NIPDAU	Level-1-260C-UNLIM	-55 to 125	HC138M	<a href="#">Samples</a>
CD74HC138ME4	ACTIVE	SOIC	D	16	40	Green (RoHS & no Sb/Br)	CU NIPDAU	Level-1-260C-UNLIM	-55 to 125	HC138M	<a href="#">Samples</a>
CD74HC138MG4	ACTIVE	SOIC	D	16	40	Green (RoHS & no Sb/Br)	CU NIPDAU	Level-1-260C-UNLIM	-55 to 125	HC138M	<a href="#">Samples</a>
CD74HC138MT	ACTIVE	SOIC	D	16	250	Green (RoHS & no Sb/Br)	CU NIPDAU	Level-1-260C-UNLIM	-55 to 125	HC138M	<a href="#">Samples</a>
CD74HC138MTG4	ACTIVE	SOIC	D	16	250	Green (RoHS & no Sb/Br)	CU NIPDAU	Level-1-260C-UNLIM	-55 to 125	HC138M	<a href="#">Samples</a>

Orderable Device	Status (1)	Package Type	Package Drawing	Pins	Package Qty	Eco Plan (2)	Lead/Ball Finish (6)	MSL Peak Temp (3)	Op Temp (°C)	Device Marking (4/5)	Samples
CD74HC238E	ACTIVE	PDIP	N	16	25	Pb-Free (RoHS)	CU NIPDAU	N / A for Pkg Type	-55 to 125	CD74HC238E	<a href="#">Samples</a>
CD74HC238EE4	ACTIVE	PDIP	N	16	25	Pb-Free (RoHS)	CU NIPDAU	N / A for Pkg Type	-55 to 125	CD74HC238E	<a href="#">Samples</a>
CD74HC238M	ACTIVE	SOIC	D	16	40	Green (RoHS & no Sb/Br)	CU NIPDAU	Level-1-260C-UNLIM	-55 to 125	HC238M	<a href="#">Samples</a>
CD74HC238M96	ACTIVE	SOIC	D	16	2500	Green (RoHS & no Sb/Br)	CU NIPDAU	Level-1-260C-UNLIM	-55 to 125	HC238M	<a href="#">Samples</a>
CD74HC238M96E4	ACTIVE	SOIC	D	16	2500	Green (RoHS & no Sb/Br)	CU NIPDAU	Level-1-260C-UNLIM	-55 to 125	HC238M	<a href="#">Samples</a>
CD74HC238M96G4	ACTIVE	SOIC	D	16	2500	Green (RoHS & no Sb/Br)	CU NIPDAU	Level-1-260C-UNLIM	-55 to 125	HC238M	<a href="#">Samples</a>
CD74HC238MG4	ACTIVE	SOIC	D	16	40	Green (RoHS & no Sb/Br)	CU NIPDAU	Level-1-260C-UNLIM	-55 to 125	HC238M	<a href="#">Samples</a>
CD74HC238MT	ACTIVE	SOIC	D	16	250	Green (RoHS & no Sb/Br)	CU NIPDAU	Level-1-260C-UNLIM	-55 to 125	HC238M	<a href="#">Samples</a>
CD74HC238NSR	ACTIVE	SO	NS	16	2000	Green (RoHS & no Sb/Br)	CU NIPDAU	Level-1-260C-UNLIM	-55 to 125	HC238M	<a href="#">Samples</a>
CD74HC238PW	ACTIVE	TSSOP	PW	16	90	Green (RoHS & no Sb/Br)	CU NIPDAU	Level-1-260C-UNLIM	-55 to 125	HJ238	<a href="#">Samples</a>
CD74HC238PWR	ACTIVE	TSSOP	PW	16	2000	Green (RoHS & no Sb/Br)	CU NIPDAU	Level-1-260C-UNLIM	-55 to 125	HJ238	<a href="#">Samples</a>
CD74HC238PWRE4	ACTIVE	TSSOP	PW	16	2000	Green (RoHS & no Sb/Br)	CU NIPDAU	Level-1-260C-UNLIM	-55 to 125	HJ238	<a href="#">Samples</a>
CD74HC238PWRG4	ACTIVE	TSSOP	PW	16	2000	Green (RoHS & no Sb/Br)	CU NIPDAU	Level-1-260C-UNLIM	-55 to 125	HJ238	<a href="#">Samples</a>
CD74HC238PWT	ACTIVE	TSSOP	PW	16	250	Green (RoHS & no Sb/Br)	CU NIPDAU	Level-1-260C-UNLIM	-55 to 125	HJ238	<a href="#">Samples</a>
CD74HCT138E	ACTIVE	PDIP	N	16	25	Pb-Free (RoHS)	CU NIPDAU	N / A for Pkg Type	-55 to 125	CD74HCT138E	<a href="#">Samples</a>
CD74HCT138M	ACTIVE	SOIC	D	16	40	Green (RoHS & no Sb/Br)	CU NIPDAU	Level-1-260C-UNLIM	-55 to 125	HCT138M	<a href="#">Samples</a>
CD74HCT138M96	ACTIVE	SOIC	D	16	2500	Green (RoHS & no Sb/Br)	CU NIPDAU	Level-1-260C-UNLIM	-55 to 125	HCT138M	<a href="#">Samples</a>
CD74HCT138M96G4	ACTIVE	SOIC	D	16	2500	Green (RoHS & no Sb/Br)	CU NIPDAU	Level-1-260C-UNLIM	-55 to 125	HCT138M	<a href="#">Samples</a>

Orderable Device	Status (1)	Package Type	Package Drawing	Pins	Package Qty	Eco Plan (2)	Lead/Ball Finish (6)	MSL Peak Temp (3)	Op Temp (°C)	Device Marking (4/5)	Samples
CD74HCT238E	ACTIVE	PDIP	N	16	25	Pb-Free (RoHS)	CU NIPDAU	N / A for Pkg Type	-55 to 125	CD74HCT238E	<a href="#">Samples</a>
CD74HCT238EE4	ACTIVE	PDIP	N	16	25	Pb-Free (RoHS)	CU NIPDAU	N / A for Pkg Type	-55 to 125	CD74HCT238E	<a href="#">Samples</a>
CD74HCT238M	ACTIVE	SOIC	D	16	40	Green (RoHS & no Sb/Br)	CU NIPDAU	Level-1-260C-UNLIM	-55 to 125	HCT238M	<a href="#">Samples</a>
CD74HCT238M96	ACTIVE	SOIC	D	16	2500	Green (RoHS & no Sb/Br)	CU NIPDAU	Level-1-260C-UNLIM	-55 to 125	HCT238M	<a href="#">Samples</a>
CD74HCT238M96G4	ACTIVE	SOIC	D	16	2500	Green (RoHS & no Sb/Br)	CU NIPDAU	Level-1-260C-UNLIM	-55 to 125	HCT238M	<a href="#">Samples</a>
CD74HCT238PW	ACTIVE	TSSOP	PW	16	90	Green (RoHS & no Sb/Br)	CU NIPDAU	Level-1-260C-UNLIM	-55 to 125	HK238	<a href="#">Samples</a>
CD74HCT238PWR	ACTIVE	TSSOP	PW	16	2000	Green (RoHS & no Sb/Br)	CU NIPDAU	Level-1-260C-UNLIM	-55 to 125	HK238	<a href="#">Samples</a>

(1) The marketing status values are defined as follows:

**ACTIVE:** Product device recommended for new designs.

**LIFEBUY:** TI has announced that the device will be discontinued, and a lifetime-buy period is in effect.

**NRND:** Not recommended for new designs. Device is in production to support existing customers, but TI does not recommend using this part in a new design.

**PREVIEW:** Device has been announced but is not in production. Samples may or may not be available.

**OBSOLETE:** TI has discontinued the production of the device.

(2) Eco Plan - The planned eco-friendly classification: Pb-Free (RoHS), Pb-Free (RoHS Exempt), or Green (RoHS & no Sb/Br) - please check <http://www.ti.com/productcontent> for the latest availability information and additional product content details.

**TBD:** The Pb-Free/Green conversion plan has not been defined.

**Pb-Free (RoHS):** TI's terms "Lead-Free" or "Pb-Free" mean semiconductor products that are compatible with the current RoHS requirements for all 6 substances, including the requirement that lead not exceed 0.1% by weight in homogeneous materials. Where designed to be soldered at high temperatures, TI Pb-Free products are suitable for use in specified lead-free processes.

**Pb-Free (RoHS Exempt):** This component has a RoHS exemption for either 1) lead-based flip-chip solder bumps used between the die and package, or 2) lead-based die adhesive used between the die and leadframe. The component is otherwise considered Pb-Free (RoHS compatible) as defined above.

**Green (RoHS & no Sb/Br):** TI defines "Green" to mean Pb-Free (RoHS compatible), and free of Bromine (Br) and Antimony (Sb) based flame retardants (Br or Sb do not exceed 0.1% by weight in homogeneous material)

(3) MSL, Peak Temp. - The Moisture Sensitivity Level rating according to the JEDEC industry standard classifications, and peak solder temperature.

(4) There may be additional marking, which relates to the logo, the lot trace code information, or the environmental category on the device.

(5) Multiple Device Markings will be inside parentheses. Only one Device Marking contained in parentheses and separated by a "-" will appear on a device. If a line is indented then it is a continuation of the previous line and the two combined represent the entire Device Marking for that device.



<sup>(6)</sup> Lead/Ball Finish - Orderable Devices may have multiple material finish options. Finish options are separated by a vertical ruled line. Lead/Ball Finish values may wrap to two lines if the finish value exceeds the maximum column width.

**Important Information and Disclaimer:** The information provided on this page represents TI's knowledge and belief as of the date that it is provided. TI bases its knowledge and belief on information provided by third parties, and makes no representation or warranty as to the accuracy of such information. Efforts are underway to better integrate information from third parties. TI has taken and continues to take reasonable steps to provide representative and accurate information but may not have conducted destructive testing or chemical analysis on incoming materials and chemicals. TI and TI suppliers consider certain information to be proprietary, and thus CAS numbers and other limited information may not be available for release.

In no event shall TI's liability arising out of such information exceed the total purchase price of the TI part(s) at issue in this document sold by TI to Customer on an annual basis.

**OTHER QUALIFIED VERSIONS OF CD54HC138, CD54HC238, CD54HCT138, CD54HCT238, CD74HC138, CD74HC238, CD74HCT138, CD74HCT238 :**

- Catalog: [CD74HC138](#), [CD74HC238](#), [CD74HCT138](#), [CD74HCT238](#)
- Automotive: [CD74HC138-Q1](#), [CD74HC138-Q1](#)
- Military: [CD54HC138](#), [CD54HC238](#), [CD54HCT138](#), [CD54HCT238](#)

NOTE: Qualified Version Definitions:

- Catalog - TI's standard catalog product
- Automotive - Q100 devices qualified for high-reliability automotive applications targeting zero defects
- Military - QML certified for Military and Defense Applications

**TAPE AND REEL INFORMATION**
**REEL DIMENSIONS**

**TAPE DIMENSIONS**

A0	Dimension designed to accommodate the component width
B0	Dimension designed to accommodate the component length
K0	Dimension designed to accommodate the component thickness
W	Overall width of the carrier tape
P1	Pitch between successive cavity centers

**TAPE AND REEL INFORMATION**

\*All dimensions are nominal

Device	Package Type	Package Drawing	Pins	SPQ	Reel Diameter (mm)	Reel Width W1 (mm)	A0 (mm)	B0 (mm)	K0 (mm)	P1 (mm)	W (mm)	Pin1 Quadrant
CD74HC138M96	SOIC	D	16	2500	330.0	16.4	6.5	10.3	2.1	8.0	16.0	Q1
CD74HC238M96	SOIC	D	16	2500	330.0	16.4	6.5	10.3	2.1	8.0	16.0	Q1
CD74HC238NSR	SO	NS	16	2000	330.0	16.4	8.2	10.5	2.5	12.0	16.0	Q1
CD74HC238PWR	TSSOP	PW	16	2000	330.0	12.4	6.9	5.6	1.6	8.0	12.0	Q1
CD74HC238PWT	TSSOP	PW	16	250	330.0	12.4	6.9	5.6	1.6	8.0	12.0	Q1
CD74HCT138M96	SOIC	D	16	2500	330.0	16.4	6.5	10.3	2.1	8.0	16.0	Q1
CD74HCT238M96	SOIC	D	16	2500	330.0	16.4	6.5	10.3	2.1	8.0	16.0	Q1
CD74HCT238PWR	TSSOP	PW	16	2000	330.0	12.4	6.9	5.6	1.6	8.0	12.0	Q1

**TAPE AND REEL BOX DIMENSIONS**

\*All dimensions are nominal

Device	Package Type	Package Drawing	Pins	SPQ	Length (mm)	Width (mm)	Height (mm)
CD74HC138M96	SOIC	D	16	2500	333.2	345.9	28.6
CD74HC238M96	SOIC	D	16	2500	333.2	345.9	28.6
CD74HC238NSR	SO	NS	16	2000	367.0	367.0	38.0
CD74HC238PWR	TSSOP	PW	16	2000	367.0	367.0	35.0
CD74HC238PWT	TSSOP	PW	16	250	367.0	367.0	35.0
CD74HCT138M96	SOIC	D	16	2500	333.2	345.9	28.6
CD74HCT238M96	SOIC	D	16	2500	333.2	345.9	28.6
CD74HCT238PWR	TSSOP	PW	16	2000	367.0	367.0	35.0

# J (R-GDIP-T\*\*)

14 LEADS SHOWN

# CERAMIC DUAL IN-LINE PACKAGE



DIM \ PINS **	14	16	18	20
A	0.300 (7,62) BSC	0.300 (7,62) BSC	0.300 (7,62) BSC	0.300 (7,62) BSC
B MAX	0.785 (19,94)	.840 (21,34)	0.960 (24,38)	1.060 (26,92)
B MIN	—	—	—	—
C MAX	0.300 (7,62)	0.300 (7,62)	0.310 (7,87)	0.300 (7,62)
C MIN	0.245 (6,22)	0.245 (6,22)	0.220 (5,59)	0.245 (6,22)



4040083/F 03/03

- NOTES:
- A. All linear dimensions are in inches (millimeters).
  - B. This drawing is subject to change without notice.
  - C. This package is hermetically sealed with a ceramic lid using glass frit.
  - D. Index point is provided on cap for terminal identification only on press ceramic glass frit seal only.
  - E. Falls within MIL STD 1835 GDIP1-T14, GDIP1-T16, GDIP1-T18 and GDIP1-T20.

N (R-PDIP-T\*\*)

PLASTIC DUAL-IN-LINE PACKAGE

16 PINS SHOWN



- NOTES:
- A. All linear dimensions are in inches (millimeters).
  - B. This drawing is subject to change without notice.
  - $\triangle C$  Falls within JEDEC MS-001, except 18 and 20 pin minimum body length (Dim A).
  - $\triangle D$  The 20 pin end lead shoulder width is a vendor option, either half or full width.

4040049/E 12/2002

D (R-PDSO-G16)

PLASTIC SMALL OUTLINE



- NOTES:
- A. All linear dimensions are in inches (millimeters).
  - B. This drawing is subject to change without notice.
  - C. Body length does not include mold flash, protrusions, or gate burrs. Mold flash, protrusions, or gate burrs shall not exceed 0.006 (0,15) each side.
  - D. Body width does not include interlead flash. Interlead flash shall not exceed 0.017 (0,43) each side.
  - E. Reference JEDEC MS-012 variation AC.

D (R-PDSO-G16)

PLASTIC SMALL OUTLINE





4211283-4/E 08/12

- NOTES:
- A. All linear dimensions are in millimeters.
  - B. This drawing is subject to change without notice.
  - C. Publication IPC-7351 is recommended for alternate designs.
  - D. Laser cutting apertures with trapezoidal walls and also rounding corners will offer better paste release. Customers should contact their board assembly site for stencil design recommendations. Refer to IPC-7525 for other stencil recommendations.
  - E. Customers should contact their board fabrication site for solder mask tolerances between and around signal pads.

PW (R-PDSO-G16)

PLASTIC SMALL OUTLINE



- NOTES:
- A. All linear dimensions are in millimeters. Dimensioning and tolerancing per ASME Y14.5M-1994.
  - B. This drawing is subject to change without notice.
  -  C. Body length does not include mold flash, protrusions, or gate burrs. Mold flash, protrusions, or gate burrs shall not exceed 0,15 each side.
  -  D. Body width does not include interlead flash. Interlead flash shall not exceed 0,25 each side.
  - E. Falls within JEDEC MO-153



PW (R-PDSO-G16)

PLASTIC SMALL OUTLINE

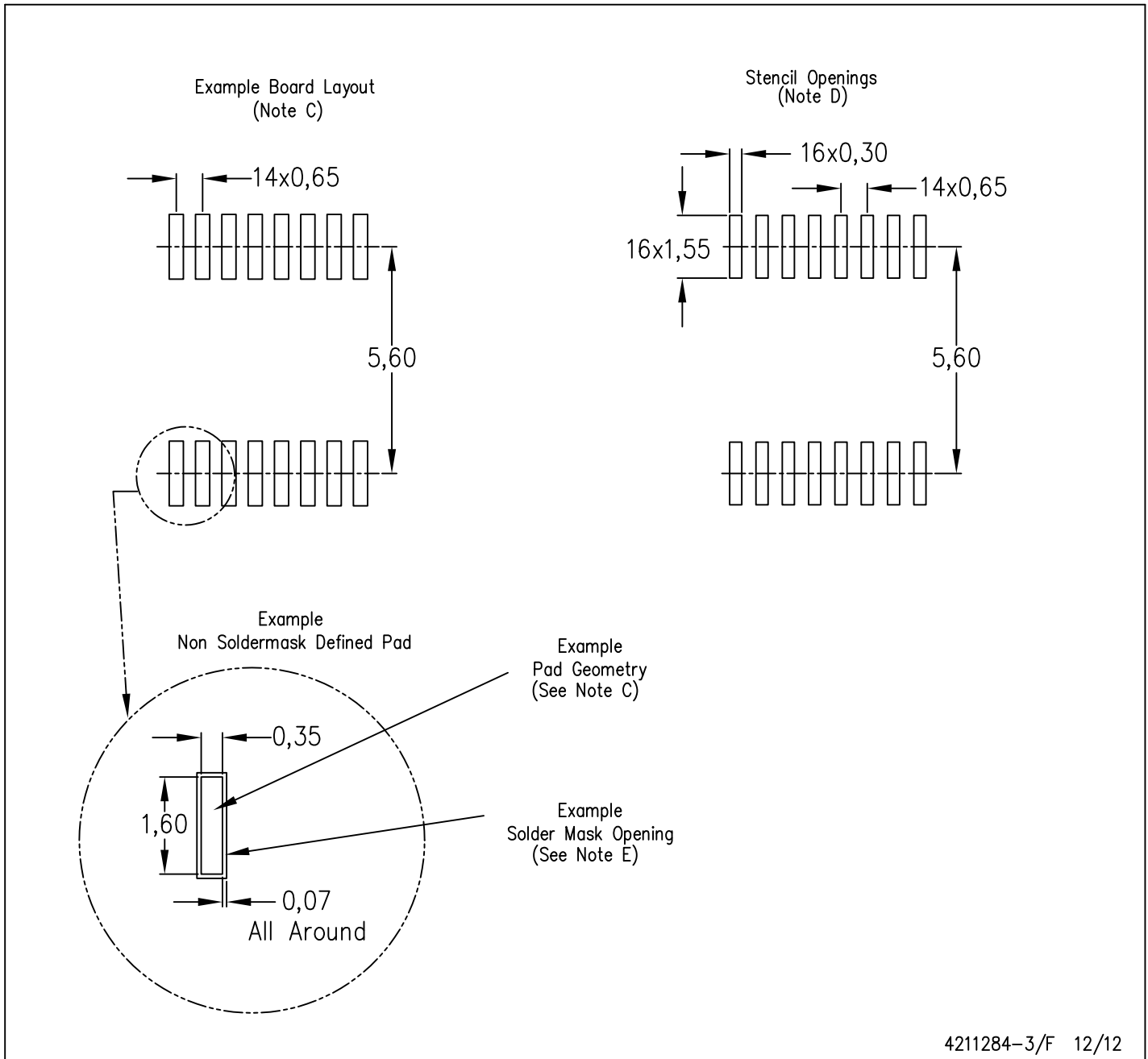

- NOTES:
- All linear dimensions are in millimeters.
  - This drawing is subject to change without notice.
  - Publication IPC-7351 is recommended for alternate designs.
  - Laser cutting apertures with trapezoidal walls and also rounding corners will offer better paste release. Customers should contact their board assembly site for stencil design recommendations. Refer to IPC-7525 for other stencil recommendations.
  - Customers should contact their board fabrication site for solder mask tolerances between and around signal pads.

# MECHANICAL DATA

NS (R-PDSO-G\*\*)

PLASTIC SMALL-OUTLINE PACKAGE

14-PINS SHOWN



- NOTES:
- All linear dimensions are in millimeters.
  - This drawing is subject to change without notice.
  - Body dimensions do not include mold flash or protrusion, not to exceed 0,15.

## IMPORTANT NOTICE

Texas Instruments Incorporated and its subsidiaries (TI) reserve the right to make corrections, enhancements, improvements and other changes to its semiconductor products and services per JESD46, latest issue, and to discontinue any product or service per JESD48, latest issue. Buyers should obtain the latest relevant information before placing orders and should verify that such information is current and complete. All semiconductor products (also referred to herein as "components") are sold subject to TI's terms and conditions of sale supplied at the time of order acknowledgment.

TI warrants performance of its components to the specifications applicable at the time of sale, in accordance with the warranty in TI's terms and conditions of sale of semiconductor products. Testing and other quality control techniques are used to the extent TI deems necessary to support this warranty. Except where mandated by applicable law, testing of all parameters of each component is not necessarily performed.

TI assumes no liability for applications assistance or the design of Buyers' products. Buyers are responsible for their products and applications using TI components. To minimize the risks associated with Buyers' products and applications, Buyers should provide adequate design and operating safeguards.

TI does not warrant or represent that any license, either express or implied, is granted under any patent right, copyright, mask work right, or other intellectual property right relating to any combination, machine, or process in which TI components or services are used. Information published by TI regarding third-party products or services does not constitute a license to use such products or services or a warranty or endorsement thereof. Use of such information may require a license from a third party under the patents or other intellectual property of the third party, or a license from TI under the patents or other intellectual property of TI.

Reproduction of significant portions of TI information in TI data books or data sheets is permissible only if reproduction is without alteration and is accompanied by all associated warranties, conditions, limitations, and notices. TI is not responsible or liable for such altered documentation. Information of third parties may be subject to additional restrictions.

Resale of TI components or services with statements different from or beyond the parameters stated by TI for that component or service voids all express and any implied warranties for the associated TI component or service and is an unfair and deceptive business practice. TI is not responsible or liable for any such statements.

Buyer acknowledges and agrees that it is solely responsible for compliance with all legal, regulatory and safety-related requirements concerning its products, and any use of TI components in its applications, notwithstanding any applications-related information or support that may be provided by TI. Buyer represents and agrees that it has all the necessary expertise to create and implement safeguards which anticipate dangerous consequences of failures, monitor failures and their consequences, lessen the likelihood of failures that might cause harm and take appropriate remedial actions. Buyer will fully indemnify TI and its representatives against any damages arising out of the use of any TI components in safety-critical applications.

In some cases, TI components may be promoted specifically to facilitate safety-related applications. With such components, TI's goal is to help enable customers to design and create their own end-product solutions that meet applicable functional safety standards and requirements. Nonetheless, such components are subject to these terms.

No TI components are authorized for use in FDA Class III (or similar life-critical medical equipment) unless authorized officers of the parties have executed a special agreement specifically governing such use.

Only those TI components which TI has specifically designated as military grade or "enhanced plastic" are designed and intended for use in military/aerospace applications or environments. Buyer acknowledges and agrees that any military or aerospace use of TI components which have **not** been so designated is solely at the Buyer's risk, and that Buyer is solely responsible for compliance with all legal and regulatory requirements in connection with such use.

TI has specifically designated certain components as meeting ISO/TS16949 requirements, mainly for automotive use. In any case of use of non-designated products, TI will not be responsible for any failure to meet ISO/TS16949.

### Products

Audio	<a href="http://www.ti.com/audio">www.ti.com/audio</a>
Amplifiers	<a href="http://amplifier.ti.com">amplifier.ti.com</a>
Data Converters	<a href="http://dataconverter.ti.com">dataconverter.ti.com</a>
DLP® Products	<a href="http://www.dlp.com">www.dlp.com</a>
DSP	<a href="http://dsp.ti.com">dsp.ti.com</a>
Clocks and Timers	<a href="http://www.ti.com/clocks">www.ti.com/clocks</a>
Interface	<a href="http://interface.ti.com">interface.ti.com</a>
Logic	<a href="http://logic.ti.com">logic.ti.com</a>
Power Mgmt	<a href="http://power.ti.com">power.ti.com</a>
Microcontrollers	<a href="http://microcontroller.ti.com">microcontroller.ti.com</a>
RFID	<a href="http://www.ti-rfid.com">www.ti-rfid.com</a>
OMAP Applications Processors	<a href="http://www.ti.com/omap">www.ti.com/omap</a>
Wireless Connectivity	<a href="http://www.ti.com/wirelessconnectivity">www.ti.com/wirelessconnectivity</a>

### Applications

Automotive and Transportation	<a href="http://www.ti.com/automotive">www.ti.com/automotive</a>
Communications and Telecom	<a href="http://www.ti.com/communications">www.ti.com/communications</a>
Computers and Peripherals	<a href="http://www.ti.com/computers">www.ti.com/computers</a>
Consumer Electronics	<a href="http://www.ti.com/consumer-apps">www.ti.com/consumer-apps</a>
Energy and Lighting	<a href="http://www.ti.com/energy">www.ti.com/energy</a>
Industrial	<a href="http://www.ti.com/industrial">www.ti.com/industrial</a>
Medical	<a href="http://www.ti.com/medical">www.ti.com/medical</a>
Security	<a href="http://www.ti.com/security">www.ti.com/security</a>
Space, Avionics and Defense	<a href="http://www.ti.com/space-avionics-defense">www.ti.com/space-avionics-defense</a>
Video and Imaging	<a href="http://www.ti.com/video">www.ti.com/video</a>

### TI E2E Community

[e2e.ti.com](http://e2e.ti.com)