



BZT52H series

Voltage regulator diodes

Rev. 7 — 1 January 2023

Product data sheet

1. General description

General-purpose Zener diodes in an SOD123F small and flat lead Surface-Mounted Device (SMD) plastic package.

2. Features and benefits

- Total power dissipation: ≤ 830 mW
- Three tolerance series: $\pm 1\%$, $\pm 2\%$ and approximately $\pm 5\%$
- Wide working voltage range: nominal 2.4 V to 75 V (E24 range)
- Small plastic package suitable for surface-mounted design

3. Applications

- General regulation functions

4. Quick reference data

Table 1. Quick reference data

Symbol	Parameter	Conditions		Min	Typ	Max	Unit
V_F	forward voltage	$I_F = 10$ mA	[1]	-	-	0.9	V
P_{tot}	total power dissipation	$T_{amb} \leq 25$ °C	[2]	-	-	375	mW
			[3]	-	-	830	mW

[1] Pulse test: $t_p \leq 300$ μ s; $\delta \leq 0.02$.

[2] Device mounted on an FR4 Printed-Circuit Board (PCB), single-sided copper, tin-plated and standard footprint.

[3] Device mounted on an FR4 PCB, single-sided copper, tin-plated, mounting pad for cathode 1 cm².

5. Pinning information

Table 2. Pinning

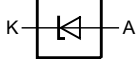
Pin	Symbol	Description		Simplified outline	Graphic symbol
1	K	cathode	[1]		 006aaa152
2	A	anode			

[1] The marking bar indicates the cathode.

6. Ordering information

Table 3. Ordering information

Type number	Package		
	Name	Description	Version
BZT52H series[1]	-	plastic surface-mounted package; 2 leads	SOD123F

[1] The series consists of 111 types with 37 breakdown voltages with nominal working voltages from 2.4 V to 75 V and $\pm 1\%$, $\pm 2\%$ and $\pm 5\%$ tolerances.

7. Marking

Table 4. Marking codes

Type number	Marking code	Type number	Marking code	Type number	Marking code
BZT52H-A2V4	FT	BZT52H-B2V4	DC	BZT52H-C2V4	B3
BZT52H-A2V7	FU	BZT52H-B2V7	DD	BZT52H-C2V7	B4
BZT52H-A3V0	FV	BZT52H-B3V0	DE	BZT52H-C3V0	B5
BZT52H-A3V3	FW	BZT52H-B3V3	DF	BZT52H-C3V3	B6
BZT52H-A3V6	FX	BZT52H-B3V6	DG	BZT52H-C3V6	B7
BZT52H-A3V9	FY	BZT52H-B3V9	DH	BZT52H-C3V9	B8
BZT52H-A4V3	FZ	BZT52H-B4V3	DJ	BZT52H-C4V3	B9
BZT52H-A4V7	G1	BZT52H-B4V7	DK	BZT52H-C4V7	BA
BZT52H-A5V1	G2	BZT52H-B5V1	DL	BZT52H-C5V1	BB
BZT52H-A5V6	G3	BZT52H-B5V6	DM	BZT52H-C5V6	BC
BZT52H-A6V2	G4	BZT52H-B6V2	DN	BZT52H-C6V2	BD
BZT52H-A6V8	G5	BZT52H-B6V8	DP	BZT52H-C6V8	BE
BZT52H-A7V5	G6	BZT52H-B7V5	DQ	BZT52H-C7V5	BF
BZT52H-A8V2	G7	BZT52H-B8V2	DR	BZT52H-C8V2	BG
BZT52H-A9V1	G8	BZT52H-B9V1	DS	BZT52H-C9V1	BH
BZT52H-A10	G9	BZT52H-B10	DT	BZT52H-C10	BJ
BZT52H-A11	GA	BZT52H-B11	DU	BZT52H-C11	BK
BZT52H-A12	GB	BZT52H-B12	DV	BZT52H-C12	BL
BZT52H-A13	GC	BZT52H-B13	DW	BZT52H-C13	BM
BZT52H-A15	GD	BZT52H-B15	DX	BZT52H-C15	BN
BZT52H-A16	GE	BZT52H-B16	DY	BZT52H-C16	BP
BZT52H-A18	GF	BZT52H-B18	DZ	BZT52H-C18	BQ
BZT52H-A20	GG	BZT52H-B20	E1	BZT52H-C20	BR
BZT52H-A22	GH	BZT52H-B22	E2	BZT52H-C22	BS
BZT52H-A24	GJ	BZT52H-B24	E3	BZT52H-C24	BT
BZT52H-A27	GK	BZT52H-B27	E4	BZT52H-C27	BU
BZT52H-A30	GL	BZT52H-B30	E5	BZT52H-C30	BV
BZT52H-A33	GM	BZT52H-B33	E6	BZT52H-C33	BW
BZT52H-A36	GN	BZT52H-B36	E7	BZT52H-C36	BX
BZT52H-A39	GP	BZT52H-B39	E8	BZT52H-C39	BY
BZT52H-A43	GY	BZT52H-B43	E9	BZT52H-C43	BZ
BZT52H-A47	GR	BZT52H-B47	EA	BZT52H-C47	C1
BZT52H-A51	GS	BZT52H-B51	EB	BZT52H-C51	C2
BZT52H-A56	GT	BZT52H-B56	EC	BZT52H-C56	C3
BZT52H-A62	GU	BZT52H-B62	ED	BZT52H-C62	C4
BZT52H-A68	GV	BZT52H-B68	EE	BZT52H-C68	C5
BZT52H-A75	GW	BZT52H-B75	EF	BZT52H-C75	C6

8. Limiting values

Table 5. Limiting values

In accordance with the Absolute Maximum Rating System (IEC 60134).

Symbol	Parameter	Conditions	Min	Max	Unit
I_F	forward current		-	250	mA
I_{ZSM}	non-repetitive peak reverse current		[1] -	see Tables 8, 9 and 10	
P_{ZSM}	non-repetitive peak reverse power dissipation		[1] -	40	W
P_{tot}	total power dissipation	$T_{amb} \leq 25\text{ °C}$	[2] -	375	mW
			[3] -	830	mW
T_j	junction temperature		-	150	°C
T_{amb}	ambient temperature		-65	+150	°C
T_{stg}	storage temperature		-65	+150	°C

[1] $t_p = 100\ \mu\text{s}$; square wave; $T_j = 25\text{ °C}$ prior to surge.

[2] Device mounted on an FR4 PCB, single-sided copper, tin-plated and standard footprint.

[3] Device mounted on an FR4 PCB, single-sided copper, tin-plated, mounting pad for cathode 1 cm^2 .

9. Thermal characteristics

Table 6. Thermal characteristics

Symbol	Parameter	Conditions	Min	Typ	Max	Unit
$R_{th(j-a)}$	thermal resistance from junction to ambient	in free air	[1] -	-	330	K/W
			[2] -	-	150	K/W
$R_{th(j-sp)}$	thermal resistance from junction to solder point		[3] -	-	70	K/W

[1] Device mounted on an FR4 PCB, single-sided copper, tin-plated and standard footprint.

[2] Device mounted on an FR4 PCB, single-sided copper, tin-plated, mounting pad for cathode 1 cm^2 .

[3] Soldering point of cathode tab.

10. Characteristics

Table 7. Characteristics

$T_j = 25\text{ °C}$ unless otherwise specified.

Symbol	Parameter	Conditions	Min	Typ	Max	Unit
V_F	forward voltage	$I_F = 10\text{ mA}$	[1] -	-	0.9	V

[1] Pulse test: $t_p \leq 300\ \mu\text{s}$; $\delta \leq 0.02$.

Table 8. Characteristics per type; BZT52H-A2V4 to BZT52H-C24

 $T_j = 25\text{ °C}$ unless otherwise specified.

BZT52H -xxx	Sel	Working voltage V_Z (V) $I_Z = 5\text{ mA}$		Maximum differential resistance r_{dif} (Ω)		Reverse current I_R (μA)		Temperature coefficient S_Z (mV/K) $I_Z = 5\text{ mA}$		Diode capacitance C_d (pF) [1]	Non-repetitive peak reverse current I_{ZSM} (A) [2]
		Min	Max	$I_Z = 1\text{ mA}$	$I_Z = 5\text{ mA}$	Max	V_R (V)	Min	Max	Max	Max
2V4	A	2.37	2.43	400	85	50	1	-3.5	0.0	450	6.0
	B	2.35	2.45								
	C	2.20	2.60								
2V7	A	2.67	2.73	500	83	20	1	-3.5	0.0	450	6.0
	B	2.65	2.75								
	C	2.50	2.90								
3V0	A	2.97	3.03	500	95	10	1	-3.5	0.0	450	6.0
	B	2.94	3.06								
	C	2.80	3.20								
3V3	A	3.26	3.34	500	95	5	1	-3.5	0.0	450	6.0
	B	3.23	3.37								
	C	3.10	3.50								
3V6	A	3.56	3.64	500	95	5	1	-3.5	0.0	450	6.0
	B	3.53	3.67								
	C	3.40	3.80								
3V9	A	3.86	3.94	500	95	3	1	-3.5	0.0	450	6.0
	B	3.82	3.98								
	C	3.70	4.10								
4V3	A	4.25	4.35	500	95	3	1	-3.5	0.0	450	6.0
	B	4.21	4.39								
	C	4.00	4.60								
4V7	A	4.65	4.75	500	78	3	2	-3.5	0.2	300	6.0
	B	4.61	4.79								
	C	4.40	5.00								
5V1	A	5.04	5.16	480	60	2	2	-2.7	1.2	300	6.0
	B	5.00	5.20								
	C	4.80	5.40								
5V6	A	5.54	5.66	400	40	1	2	-2.0	2.5	300	6.0
	B	5.49	5.71								
	C	5.20	6.00								
6V2	A	6.13	6.27	150	10	3	4	0.4	3.7	200	6.0
	B	6.08	6.32								
	C	5.80	6.60								
6V8	A	6.73	6.87	80	8	2	4	1.2	4.5	200	6.0
	B	6.66	6.94								
	C	6.40	7.20								
7V5	A	7.42	7.58	80	10	1	5	2.5	5.3	150	4.0
	B	7.35	7.65								
	C	7.00	7.90								

BZT52H -xxx	Sel	Working voltage V_Z (V) $I_Z = 5$ mA		Maximum differential resistance r_{dif} (Ω)		Reverse current I_R (μ A)		Temperature coefficient S_Z (mV/K) $I_Z = 5$ mA		Diode capacitance C_d (pF) [1]	Non-repetitive peak reverse current I_{ZSM} (A) [2]
		Min	Max	$I_Z = 1$ mA	$I_Z = 5$ mA	Max	V_R (V)	Min	Max	Max	Max
8V2	A	8.11	8.29	80	10	0.7	5	3.2	6.2	150	4.0
	B	8.04	8.36								
	C	7.70	8.70								
9V1	A	9.00	9.20	100	10	0.5	6	3.8	7.0	150	3.0
	B	8.92	9.28								
	C	8.50	9.60								
10	A	9.90	10.10	70	10	0.2	7	4.5	8.0	90	3.0
	B	9.80	10.20								
	C	9.40	10.60								
11	A	10.89	11.11	70	10	0.1	8	5.4	9.0	85	2.5
	B	10.80	11.20								
	C	10.40	11.60								
12	A	11.88	12.12	90	10	0.1	8	6.0	10.0	85	2.5
	B	11.80	12.20								
	C	11.40	12.70								
13	A	12.87	13.13	110	10	0.1	8	7.0	11.0	80	2.5
	B	12.70	13.30								
	C	12.40	14.10								
15	A	14.85	15.15	110	15	0.05	10.5	9.2	13.0	75	2.0
	B	14.70	15.30								
	C	13.80	15.60								
16	A	15.84	16.16	170	20	0.05	11.2	10.4	14.0	75	1.5
	B	15.70	16.30								
	C	15.30	17.10								
18	A	17.82	18.18	170	20	0.05	12.6	12.4	16.0	70	1.5
	B	17.60	18.40								
	C	16.80	19.10								
20	A	19.80	20.20	220	20	0.05	14	14.4	18.0	60	1.5
	B	19.60	20.40								
	C	18.80	21.20								
22	A	21.78	22.22	220	25	0.05	15.4	16.4	20.0	60	1.25
	B	21.60	22.40								
	C	20.80	23.30								
24	A	23.76	24.24	220	30	0.05	16.8	18.4	22.0	55	1.25
	B	23.50	24.50								
	C	22.80	25.60								

[1] $f = 1$ MHz; $V_R = 0$ V

[2] $t_p = 100$ μ s; $T_{amb} = 25$ °C

Table 9. Characteristics per type; BZT52H-A27 to BZT52H-C51

 $T_j = 25\text{ °C}$ unless otherwise specified.

BZT52H -xxx	Sel	Working voltage V_Z (V) $I_Z = 2\text{ mA}$		Maximum differential resistance r_{dif} (Ω)		Reverse current I_R (μA)		Temperature coefficient S_Z (mV/K) $I_Z = 2\text{ mA}$		Diode capacitance C_d (pF) [1]	Non-repetitive peak reverse current I_{ZSM} (A) [2]
		Min	Max	$I_Z = 1\text{ mA}$	$I_Z = 5\text{ mA}$	Max	V_R (V)	Min	Max	Max	Max
27	A	26.73	27.27	250	40	0.05	18.9	21.4	25.3	50	1.0
	B	26.50	27.50								
	C	25.10	28.90								
30	A	29.70	30.30	250	40	0.05	21	24.4	29.4	50	1.0
	B	29.40	30.60								
	C	28.00	32.00								
33	A	32.67	33.33	250	40	0.05	23.1	27.4	33.4	45	0.9
	B	32.30	33.70								
	C	31.00	35.00								
36	A	35.64	36.36	250	60	0.05	25.2	30.4	37.4	45	0.8
	B	35.30	36.70								
	C	34.00	38.00								
39	A	38.61	39.39	300	75	0.05	27.3	33.4	41.2	45	0.7
	B	38.20	39.80								
	C	37.00	41.00								
43	A	42.57	43.43	325	80	0.05	30.1	37.6	46.6	40	0.6
	B	42.10	43.90								
	C	40.00	46.00								
47	A	46.53	47.47	325	90	0.05	32.9	42.0	51.8	40	0.5
	B	46.10	47.90								
	C	44.00	50.00								
51	A	50.49	51.51	350	100	0.05	35.7	46.6	57.2	40	0.4
	B	50.00	52.00								
	C	48.00	54.00								

[1] $f = 1\text{ MHz}$; $V_R = 0\text{ V}$ [2] $t_p = 100\text{ }\mu\text{s}$; $T_{amb} = 25\text{ °C}$.

Table 10. Characteristics per type; BZT52H-A56 to BZT52H-C75

$T_j = 25\text{ °C}$ unless otherwise specified.

BZT52H -xxx	Sel	Working voltage V_Z (V) $I_Z = 2\text{ mA}$		Maximum differential resistance r_{dif} (Ω)		Reverse current I_R (μA)		Temperature coefficient S_Z (mV/K) $I_Z = 2\text{ mA}$		Diode capacitance C_d (pF) [1]	Non-repetitive peak reverse current I_{ZSM} (A) [2]
		Min	Max	$I_Z = 0.5\text{ mA}$	$I_Z = 2\text{ mA}$	Max	V_R (V)	Min	Max	Max	Max
56	A	55.44	56.56	375	120	0.05	39.2	52.2	63.8	40	0.3
	B	54.90	57.10								
	C	52.00	60.00								
62	A	61.38	62.62	400	140	0.05	43.4	58.8	71.6	35	0.3
	B	60.80	63.20								
	C	58.00	66.00								
68	A	67.32	68.68	400	160	0.05	47.6	65.6	79.8	35	0.25
	B	66.60	69.40								
	C	64.00	72.00								
75	A	74.25	75.75	400	175	0.05	52.5	73.4	88.6	35	0.20
	B	73.50	76.50								
	C	70.00	79.00								

[1] $f = 1\text{ MHz}$; $V_R = 0\text{ V}$

[2] $t_p = 100\text{ }\mu\text{s}$; $T_{amb} = 25\text{ °C}$.

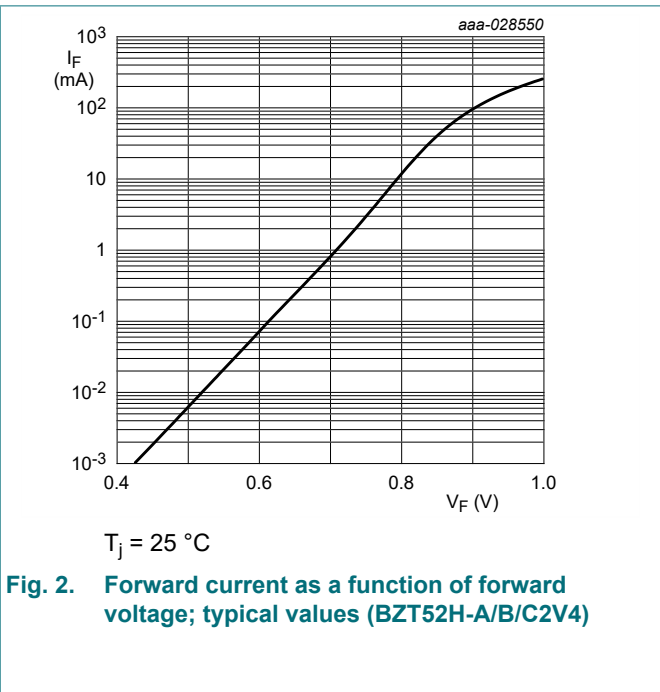
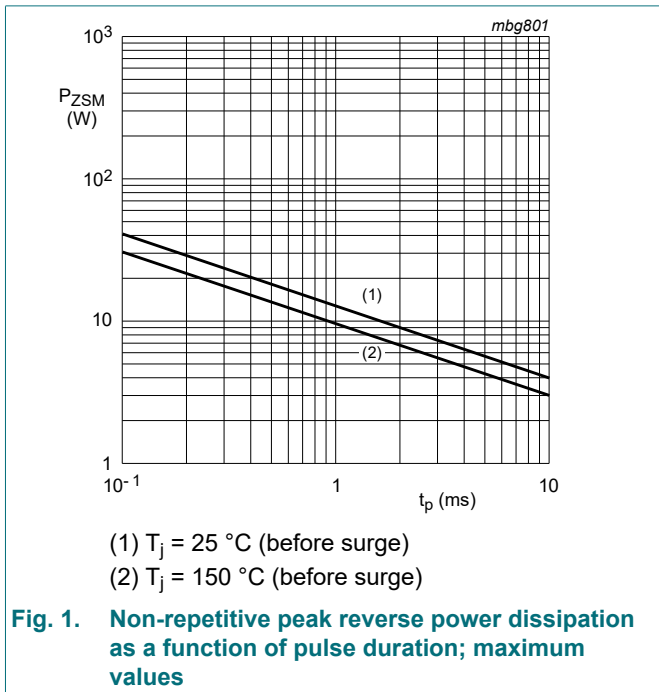

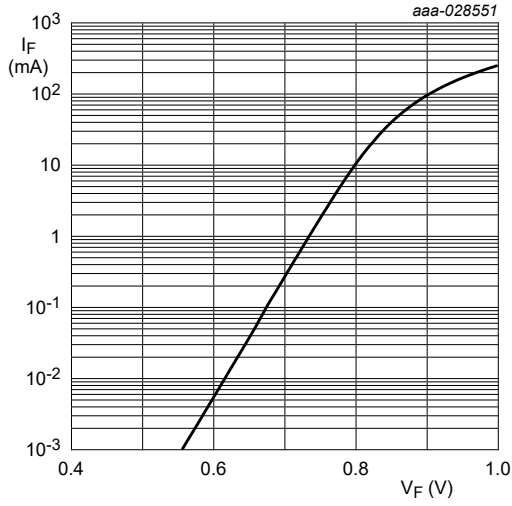

$T_j = 25\text{ }^\circ\text{C}$

Fig. 3. Forward current as a function of forward voltage; typical values (BZT52H-A/B/C6V8)

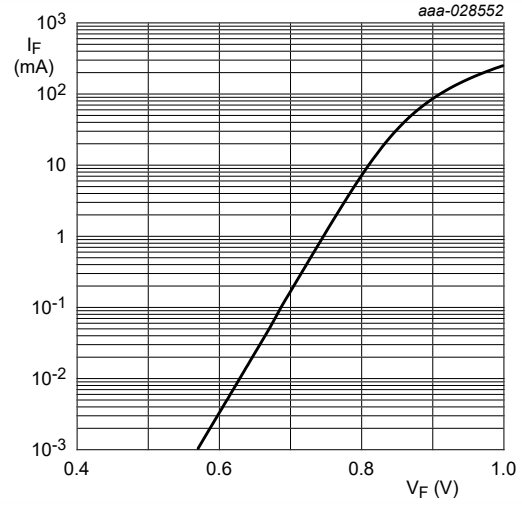

$T_j = 25\text{ }^\circ\text{C}$

Fig. 4. Forward current as a function of forward voltage; typical values (BZT52H-A/B/C7V5)

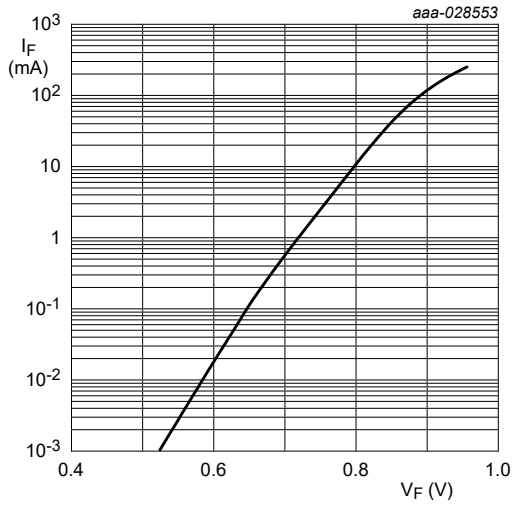

$T_j = 25\text{ }^\circ\text{C}$

Fig. 5. Forward current as a function of forward voltage; typical values (BZT52H-A/B/C7V5)

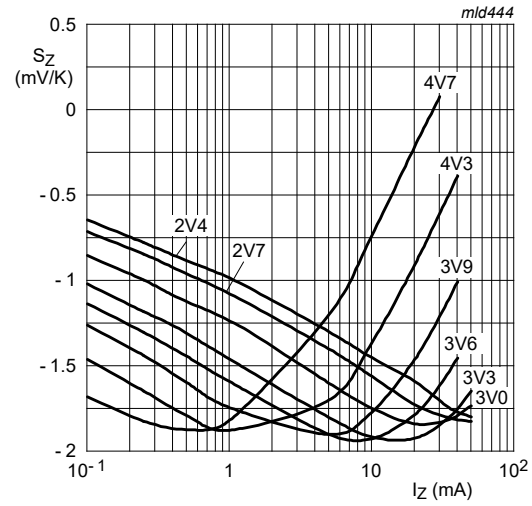

$T_j = 25\text{ }^\circ\text{C to } 150\text{ }^\circ\text{C}$

Fig. 6. Temperature coefficient as a function of working current; typical values (BZT52H-A/B/C2V4 to BZT52H-A/B/C4V7)

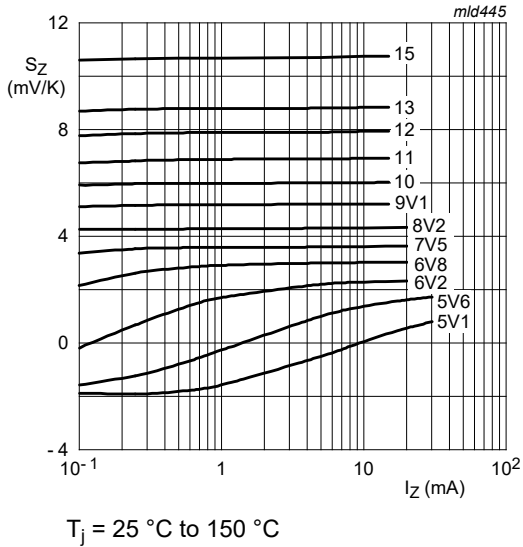

Fig. 7. Temperature coefficient as a function of working current; typical values (BZT52H-A/B/C5V1 to BZT52H-A/B/C15)

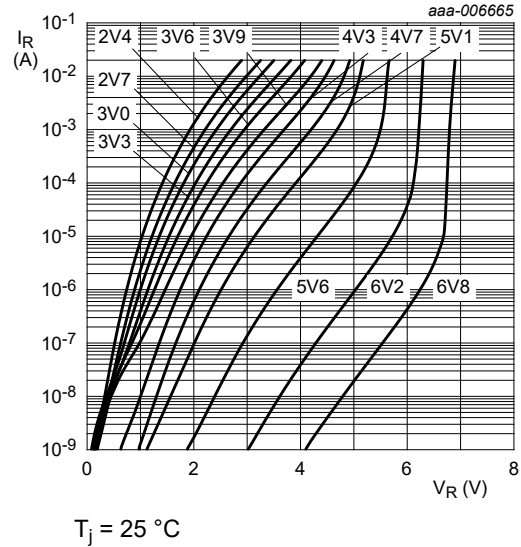

Fig. 8. Reverse current as a function of reverse voltage; typical values (BZT52H-A/B/C2V4 to BZT52H-A/B/C6V8)

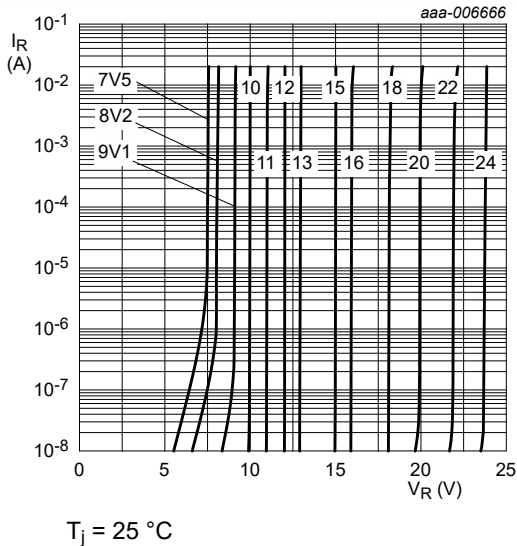

Fig. 9. Reverse current as a function of reverse voltage; typical values (BZT52H-A/B/C7V5 to BZT52H-A/B/C24)

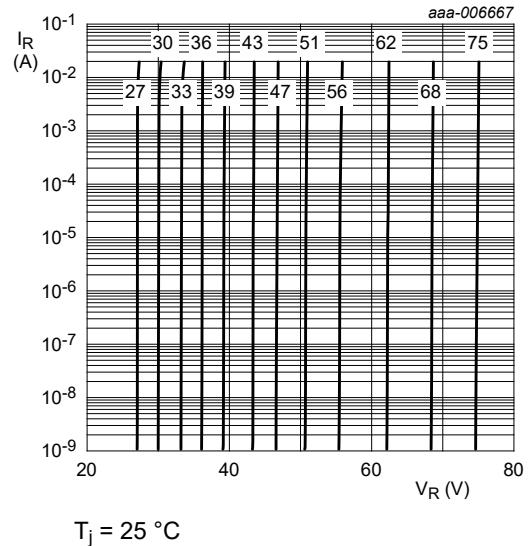

Fig. 10. Reverse current as a function of reverse voltage; typical values (BZT52H-A/B/C27 to BZT52H-A/B/C75)

11. Package outline

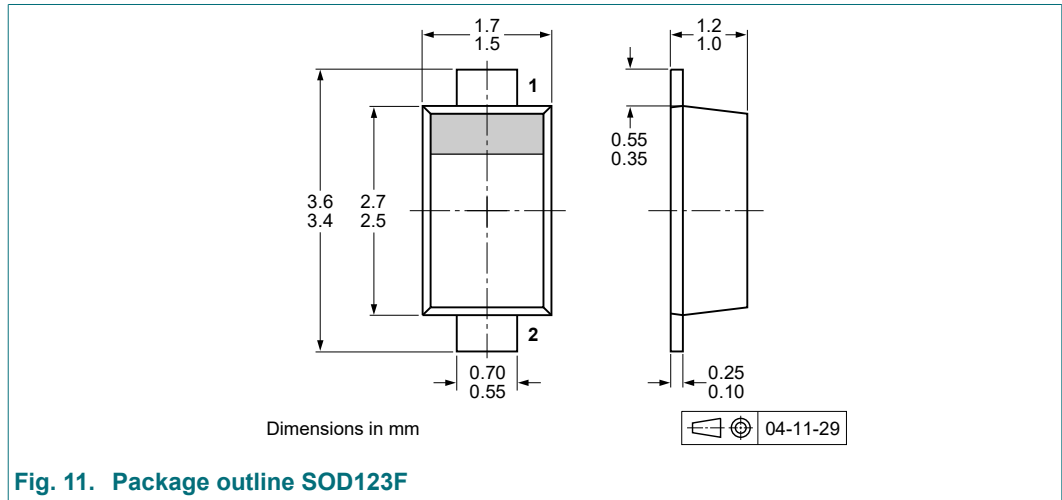

Fig. 11. Package outline SOD123F

12. Soldering

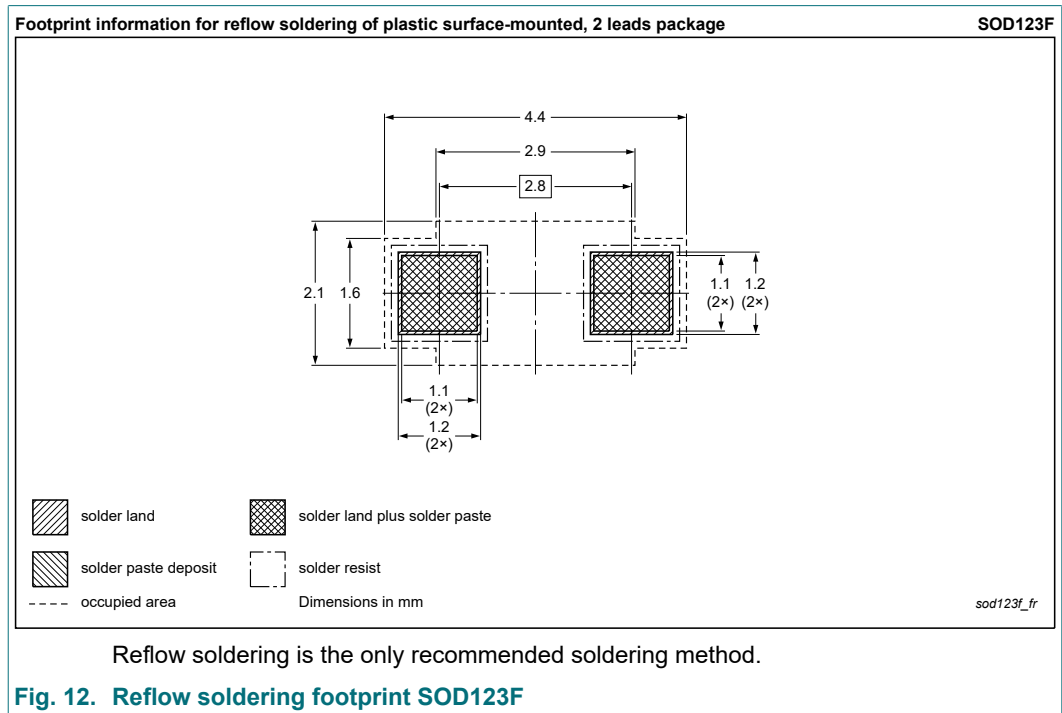

Fig. 12. Reflow soldering footprint SOD123F

13. Revision history

Table 11. Revision history

Document ID	Release date	Data sheet status	Change notice	Supersedes
BZT52H_SER v.7	20230101	Product data sheet	-	BZT52H_SER v.6
Modifications:	<ul style="list-style-type: none"> BZT52H-A selections added Products changed to non-automotive qualification. Please refer to nexperia.com for automotive (-Q) product alternatives. 			
BZT52H_SER v.6	20220207	Product data sheet	-	BZT52H_SER v.5
BZT52H_SER v.5	20201130	Product data sheet	-	BZT52H_SER v.4
BZT52H_SER v.4	20190121	Product data sheet	-	BZT52H_SER v.3
BZT52H_SER v.3	20091115	Product data sheet	-	BZT52H_SER v.2
BZT52H_SER v.2	20091115	Product data sheet	-	BZT52H_SER v.1
BZT52H_SER v.1	20051222	Product data sheet	-	-

14. Legal information

Data sheet status

Document status [1][2]	Product status [3]	Definition
Objective [short] data sheet	Development	This document contains data from the objective specification for product development.
Preliminary [short] data sheet	Qualification	This document contains data from the preliminary specification.
Product [short] data sheet	Production	This document contains the product specification.

- [1] Please consult the most recently issued document before initiating or completing a design.
- [2] The term 'short data sheet' is explained in section "Definitions".
- [3] The product status of device(s) described in this document may have changed since this document was published and may differ in case of multiple devices. The latest product status information is available on the internet at <https://www.nexperia.com>.

Definitions

Draft — The document is a draft version only. The content is still under internal review and subject to formal approval, which may result in modifications or additions. Nexperia does not give any representations or warranties as to the accuracy or completeness of information included herein and shall have no liability for the consequences of use of such information.

Short data sheet — A short data sheet is an extract from a full data sheet with the same product type number(s) and title. A short data sheet is intended for quick reference only and should not be relied upon to contain detailed and full information. For detailed and full information see the relevant full data sheet, which is available on request via the local Nexperia sales office. In case of any inconsistency or conflict with the short data sheet, the full data sheet shall prevail.

Product specification — The information and data provided in a Product data sheet shall define the specification of the product as agreed between Nexperia and its customer, unless Nexperia and customer have explicitly agreed otherwise in writing. In no event however, shall an agreement be valid in which the Nexperia product is deemed to offer functions and qualities beyond those described in the Product data sheet.

Disclaimers

Limited warranty and liability — Information in this document is believed to be accurate and reliable. However, Nexperia does not give any representations or warranties, expressed or implied, as to the accuracy or completeness of such information and shall have no liability for the consequences of use of such information. Nexperia takes no responsibility for the content in this document if provided by an information source outside of Nexperia.

In no event shall Nexperia be liable for any indirect, incidental, punitive, special or consequential damages (including - without limitation - lost profits, lost savings, business interruption, costs related to the removal or replacement of any products or rework charges) whether or not such damages are based on tort (including negligence), warranty, breach of contract or any other legal theory.

Notwithstanding any damages that customer might incur for any reason whatsoever, Nexperia's aggregate and cumulative liability towards customer for the products described herein shall be limited in accordance with the Terms and conditions of commercial sale of Nexperia.

Right to make changes — Nexperia reserves the right to make changes to information published in this document, including without limitation specifications and product descriptions, at any time and without notice. This document supersedes and replaces all information supplied prior to the publication hereof.

Suitability for use — Nexperia products are not designed, authorized or warranted to be suitable for use in life support, life-critical or safety-critical systems or equipment, nor in applications where failure or malfunction of an Nexperia product can reasonably be expected to result in personal

injury, death or severe property or environmental damage. Nexperia and its suppliers accept no liability for inclusion and/or use of Nexperia products in such equipment or applications and therefore such inclusion and/or use is at the customer's own risk.

Quick reference data — The Quick reference data is an extract of the product data given in the Limiting values and Characteristics sections of this document, and as such is not complete, exhaustive or legally binding.

Applications — Applications that are described herein for any of these products are for illustrative purposes only. Nexperia makes no representation or warranty that such applications will be suitable for the specified use without further testing or modification.

Customers are responsible for the design and operation of their applications and products using Nexperia products, and Nexperia accepts no liability for any assistance with applications or customer product design. It is customer's sole responsibility to determine whether the Nexperia product is suitable and fit for the customer's applications and products planned, as well as for the planned application and use of customer's third party customer(s). Customers should provide appropriate design and operating safeguards to minimize the risks associated with their applications and products.

Nexperia does not accept any liability related to any default, damage, costs or problem which is based on any weakness or default in the customer's applications or products, or the application or use by customer's third party customer(s). Customer is responsible for doing all necessary testing for the customer's applications and products using Nexperia products in order to avoid a default of the applications and the products or of the application or use by customer's third party customer(s). Nexperia does not accept any liability in this respect.

Limiting values — Stress above one or more limiting values (as defined in the Absolute Maximum Ratings System of IEC 60134) will cause permanent damage to the device. Limiting values are stress ratings only and (proper) operation of the device at these or any other conditions above those given in the Recommended operating conditions section (if present) or the Characteristics sections of this document is not warranted. Constant or repeated exposure to limiting values will permanently and irreversibly affect the quality and reliability of the device.

Terms and conditions of commercial sale — Nexperia products are sold subject to the general terms and conditions of commercial sale, as published at <http://www.nexperia.com/profile/terms>, unless otherwise agreed in a valid written individual agreement. In case an individual agreement is concluded only the terms and conditions of the respective agreement shall apply. Nexperia hereby expressly objects to applying the customer's general terms and conditions with regard to the purchase of Nexperia products by customer.

No offer to sell or license — Nothing in this document may be interpreted or construed as an offer to sell products that is open for acceptance or the grant, conveyance or implication of any license under any copyrights, patents or other industrial or intellectual property rights.

Export control — This document as well as the item(s) described herein may be subject to export control regulations. Export might require a prior authorization from competent authorities.

Non-automotive qualified products — Unless this data sheet expressly states that this specific Nexperia product is automotive qualified, the product is not suitable for automotive use. It is neither qualified nor tested in accordance with automotive testing or application requirements. Nexperia accepts no liability for inclusion and/or use of non-automotive qualified products in automotive equipment or applications.

In the event that customer uses the product for design-in and use in automotive applications to automotive specifications and standards, customer (a) shall use the product without Nexperia's warranty of the product for such automotive applications, use and specifications, and (b) whenever customer uses the product for automotive applications beyond Nexperia's specifications such use shall be solely at customer's own risk, and (c) customer fully indemnifies Nexperia for any liability, damages or failed product claims resulting from customer design and use of the product for automotive applications beyond Nexperia's standard warranty and Nexperia's product specifications.

Translations — A non-English (translated) version of a document is for reference only. The English version shall prevail in case of any discrepancy between the translated and English versions.

Trademarks

Notice: All referenced brands, product names, service names and trademarks are the property of their respective owners.

Contents

1. General description.....	1
2. Features and benefits.....	1
3. Applications.....	1
4. Quick reference data.....	1
5. Pinning information.....	2
6. Ordering information.....	2
7. Marking.....	3
8. Limiting values.....	4
9. Thermal characteristics.....	4
10. Characteristics.....	4
11. Package outline.....	11
12. Soldering.....	11
13. Revision history.....	12
14. Legal information.....	13

© Nexperia B.V. 2023. All rights reserved

For more information, please visit: <http://www.nexperia.com>

For sales office addresses, please send an email to: salesaddresses@nexperia.com

Date of release: 1 January 2023
