

BQ25887 I2C Controlled 2-Cell, 2-A boost-mode battery charger with power path cell balancing for USB input

1 Features

- High-efficiency 2-A, 1.5MHz switch mode boost charger
 - 93.4% Charge efficiency at 5V adapter, 7.6-V battery, 1-A charge
 - Optimized for USB input and 2-cell Li-Ion battery
 - Selectable low power PFM mode for light load operation
- Single input to support USB input adapters
 - Supports 3.9 V – 6.2 V input voltage range with 20-V absolute maximum input voltage rating
 - Input current limit (500 mA to 3.3 A with 100-mA resolution) to support USB2.0, USB3.0 standard adapters
 - Maximum power tracking by input voltage limit up-to 5.5 V
- Cell balancing and I²C control
 - Integrated FETs for balancing current up to 400 mA
 - Automatic cell balancing with default register setting
- Input current optimizer (ICO) to maximize input power without overloading adapters
- Integrated 16-bit ADC for system monitoring (BUS voltage and current, each cell voltage, charge current, SYS voltage, and NTC and die temperature)
- High integration includes all MOSFETs, current sensing and loop compensation
- High accuracy
 - ±0.5% Charge voltage regulation
 - ±5% Charge current regulation
 - ±7.5% Input current regulation
- Safety

- Battery temperature sensing in charge
- Thermal regulation and thermal shutdown

2 Applications

- E-Cigarette
- Drone payload control

3 Description

The BQ25887 is a highly-integrated 2-A boost switch-mode battery charge management and system power path management device for Dual-cell (2s) Li-Ion and Li-polymer battery. The BQ25887 has I2C control with cell balancing, no OTG, and no power path.

Device Information⁽¹⁾

PART NUMBER	PACKAGE	BODY SIZE (NOM)
BQ25887	VQFN (24)	4.00 mm x 4.00 mm

(1) For all available packages, see the orderable addendum at the end of the data sheet.

Simplified Schematic

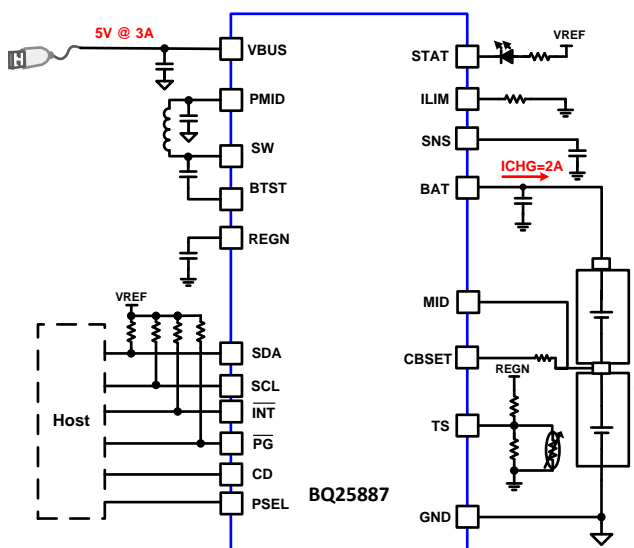

Table of Contents

1 Features	1	8.4 Device Functional Modes	29
2 Applications	1	8.5 Register Maps	30
3 Description	1	9 Application and Implementation	68
4 Revision History	2	9.1 Application Information	68
5 Device Comparison Table	3	9.2 Typical Application	68
6 Pin Configuration and Functions	4	10 Power Supply Recommendations	73
7 Specifications	6	11 Layout	73
7.1 Absolute Maximum Ratings	6	11.1 Layout Guidelines	73
7.2 ESD Ratings	6	11.2 Layout Example	74
7.3 Recommended Operating Conditions	6	12 Device and Documentation Support	75
7.4 Thermal Information	6	12.1 Device Support	75
7.5 Electrical Characteristics	7	12.2 Documentation Support	75
7.6 Timing Requirements	11	12.3 Receiving Notification of Documentation Updates	75
7.7 Typical Characteristics	12	12.4 Community Resources	75
8 Detailed Description	14	12.5 Trademarks	75
8.1 Overview	14	12.6 Electrostatic Discharge Caution	75
8.2 Functional Block Diagram	14	12.7 Glossary	75
8.3 Feature Description	15	13 Mechanical, Packaging, and Orderable Information	76

4 Revision History

DATE	REVISION	NOTES
February 2019	*	Advance Information release.

5 Device Comparison Table

Table 1. Device Comparison

PART NUMBER	BQ25882	BQ25883	BQ25886	BQ25887
VBUS Operating Range	3.9 to 6.2 V	3.9 to 6.2 V	4.3 to 6.2 V	3.9 to 6.2 V
USB Detection	D+/D-	D+/D-	D+/D-	PSEL
Power Path	Yes	Yes	Yes	No
Cell Balancing	No	No	No	Yes
OTG	Up to 2 A	Up to 2 A	Up to 2 A	No OTG
16 bit ADC	Yes	Yes	No	Yes
Control Interface	I2C	I2C	Standalone	I2C
Status Pin	/PG	STAT, /PG	STAT, /PG	STAT, /PG
Package	2.1x2.1 WCSP-25	4x4 QFN-24	4x4 QFN-24	4x4 QFN-24

6 Pin Configuration and Functions

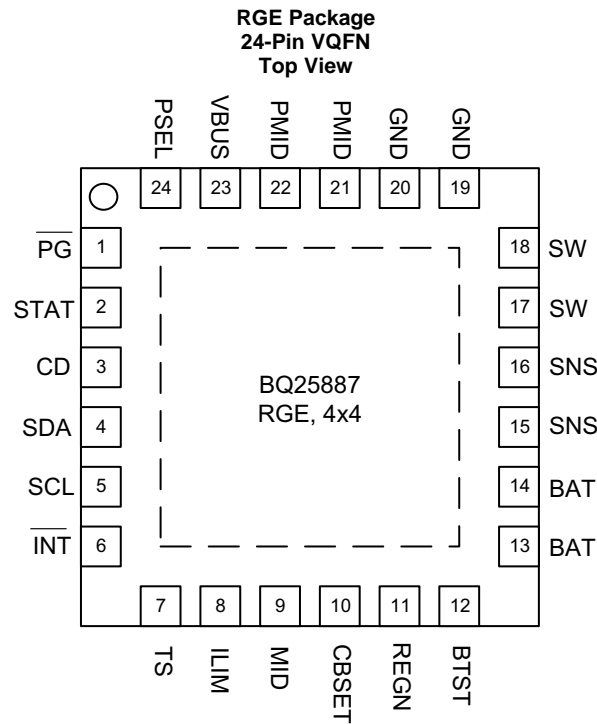

Pin Functions

PIN		I/O	DESCRIPTION
NAME	NO.		
$\overline{\text{PG}}$	1	DO	Open drain active low power good indicator – Connect to the pull up rail via 10-k Ω resistor. LOW indicates a good input source if the input voltage is within VVBUS_OP, and can provide more than IPOORSRC (30mA).
STAT	2	DO	Open drain charge status indicator – Connect to the pull-up rail via 10-k Ω resistor. LOW indicates charge in progress. HIGH indicates charge complete or charge disabled. When any fault occurs, the STAT pin blinks at 1Hz. The STAT function can be disabled when the STAT_DIS bit is set.
CD	3	DI	Active High Chip Disable Pin – Pull CD high to disable charge and place the device in HIZ mode. ADC operation and I2C is still allowed when CD is high. Converter is enabled when CD pin is LOW and EN_CHG bit is 1. CD pin is internally pulled low with 900-k Ω resistor.
SDA	4	DIO	I2C Interface Data – Connect SDA to the pull up rail through a 10-k Ω resistor.
SCL	5	DI	I2C Interface Clock – Connect SCL to the pull up rail through a 10-k Ω resistor.
$\overline{\text{INT}}$	6	DO	Open drain active Interrupt Output – Connect $\overline{\text{INT}}$ to the pull up rail via a 10-k Ω resistor. The $\overline{\text{INT}}$ pin sends active low, 256- μ s pulse to the host to report charger device status and fault.
TS	7	AI	Temperature Qualification Voltage – Connect a negative temperature coefficient thermistor. Program temperature window with a resistor divider from REGN to TS to GND. Charge suspends when TS pin is out of range. Recommend 103AT-2 thermistor.
ILIM	8	AI	Input Current Limit (IINDPM) – ILIM pin sets the maximum input current and can be used to monitor input current. IINDPM loop regulates ILIM pin voltage at 0.8V. When ILIM pin is less than 0.8V, the input current can be calculated by $IIN = KILIM \times VILIM / (RILIM \times 0.8V)$. A resistor connected from ILIM pin to ground sets the input current limit as maximum ($IINMAX = KILIM / RILIM$). The actual input current limit is the lower limit set by ILIM pin (when EN_ILIM bit is HIGH) or IINDPM register bits. Input current limit less than 500mA is not supported on ILIM pin. The ILIM pin function can be disabled when EN_ILIM bit is 0. If ILIM pin is not used, pull this pin to GND.
MID	9	AI	Voltage Input for Mid Point Between Cells in 2S1P Configuration – Connect MID to the negative terminal of the top cell and the positive terminal of the bottom cell. This pin measures the voltage of the bottom cell for cell balancing and VMID ADC measurement. For protection of bottom cell reverse plug in, connect a 300 ohm resistor in series between MID pin and mid connection point of the two battery cell.

Pin Functions (continued)

PIN		I/O	DESCRIPTION
NAME	NO.		
CBSET	10	P	Power pin for Cell Balancing – Connect CBSET to the mid point between the two batteries in 2S configuration with a current limit resistor. The resistor value determines the cell balancing current as calculated in Cell Balancing Section. The resistor chosen should not exceed 400 mA for cell balancing.
REGN	11	P	Gate Drive Supply – Bias supply for internal MOSFETs driver and IC. Bypass REGN to GND with a 4.7- μ F ceramic capacitor. REGN current limit is 50 mA.
BTST	12	P	PWM High-side Driver Supply – Internally, BTST is connected to the cathode of the boot-strap diode. Connect a 47nF bootstrap capacitor from SW to BTST.
BAT	13, 14	P	Battery Power Connection – Connect a 10- μ F ceramic capacitor closely to the BAT pin and GND.
SNS	15, 16	AO	Sense Output – Charge current sense pin. Place a 44- μ F ceramic capacitor on this pin for stability of this output.
SW	17, 18	P	Inductor Connection – Connect to the switched side of the external inductor.
GND	19, 20,	–	Ground Return
PMID	21, 22	P	Blocking MOSFET Connection – Given the total input capacitance, place 1 μ F on VBUS, and the rest on PMID, as close to the IC as possible. Typical value: 10- μ F ceramic capacitor
VBUS	23	P	Input Supply – VBUS is connected to the external DC supply. Bypass VBUS to GND with at least 1- μ F ceramic capacitor, placed as close to the IC as possible.
PSEL	24	DI	Power Source Selection – HIGH indicates USB host source (500mA) and LOW indicates adapter source (3.0A).

7 Specifications

7.1 Absolute Maximum Ratings

over operating free-air temperature range (unless otherwise noted)

		MIN	MAX	UNIT
Voltage Range (with respect to GND unless otherwise specified)	VBUS (converter not switching)	-0.3	20	V
	PMID (converter not switching)	-0.3	8.5	V
	BAT, SNS, MID, CBSET (converter not switching)	-0.3	12	V
	SW	-0.3	13	V
	BTST	-0.3	19	V
	REGN, STAT, \overline{PG} , TS	-0.3	6	V
	ILIM	-0.3	5	V
	BTST to SW	-0.3	6	V
	, SDA, SCL, \overline{INT} , CD, PSEL	-0.3	6	V
Voltage Range (with respect to GND unless otherwise specified)	BAT to CBSET	0	12	V
Output Sink Current	\overline{INT} , STAT, \overline{PG}		6	mA
Discharge Current	BAT		6.5	A
Junction Temperature, T_J		-40	150	°C
Storage temperature, T_{stg}		-40	150	°C

7.2 ESD Ratings

			VALUE	UNIT
$V_{(ESD)}$	Electrostatic discharge	Human body model (HBM), per ANSI/ESDA/JEDEC JS-001 ⁽¹⁾	±2000	V
		Charged device model (CDM), per JEDEC specification JESD22-C101 ⁽²⁾	±250	V

(1) JEDEC document JEP155 states that 500-V HBM allows safe manufacturing with a standard ESD control process.

(2) JEDEC document JEP157 states that 250-V CDM allows safe manufacturing with a standard ESD control process.

7.3 Recommended Operating Conditions

over operating free-air temperature range (unless otherwise noted)

		MIN	NOM	MAX	UNIT
V_{VBUS}	Input Voltage	3.9		6.2	V
I_{VBUS}	Average input current (VBUS)			3.3	A
I_{BAT}	Average charge current (IBAT)			2.2	A
V_{BAT}	Battery Voltage			9.2 ⁽¹⁾	V
T_A	Operating free-air temperature range	-40		85	°C

(1) The inherent switching noise voltage spikes should not exceed the absolute maximum rating on SW pin. A tight layout minimizes switching noise.

7.4 Thermal Information

over operating free-air temperature range (unless otherwise noted)

THERMAL METRIC ⁽¹⁾		bq25887	UNIT
		RGE (VQFN)	
		24-PIN	
$R_{\theta JA}$	Junction-to-ambient thermal resistance	32.4	°C/W
$R_{\theta JC(top)}$	Junction-to-case (top) thermal resistance	26.7	°C/W
$R_{\theta JB}$	Junction-to-board thermal resistance	10.7	°C/W

(1) For more information about traditional and new thermal metrics, see the Semiconductor and IC Package Thermal Metrics application report, [SPRA953](#).

Thermal Information (continued)

over operating free-air temperature range (unless otherwise noted)

THERMAL METRIC ⁽¹⁾		bq25887	
		RGE (VQFN)	
		24-PIN	
			UNIT
Ψ_{JT}	Junction-to-top characterization parameter	0.4	°C/W
Ψ_{JB}	Junction-to-board characterization parameter	10.6	°C/W
$R_{\theta JC(bot)}$	Junction-to-case (bottom) thermal resistance	3.7	°C/W

7.5 Electrical Characteristics

 $V_{VBUS_UVLOZ} < V_{VBUS} < V_{VBUS_OV}$, $T_J = -40^{\circ}\text{C}$ to $+125^{\circ}\text{C}$, and $T_J = 25^{\circ}\text{C}$ for typical values (unless otherwise noted)

PARAMETER		TEST CONDITIONS	MIN	TYP	MAX	UNIT
QUIESCENT CURRENTS						
I_{BAT}	Battery discharge current (BAT)	VBAT = 9 V, No VBUS, SCL, SDA = 0 V or 1.8 V, $T_J = 25^{\circ}\text{C}$, ADC Disabled		12	14	μA
		VBAT = 9 V, No VBUS, SCL, SDA = 0 V or 1.8 V, $T_J < 85^{\circ}\text{C}$, ADC Disabled		12	20	μA
I_{VBUS_HIZ}	Input supply current (VBUS) in HIZ	VBUS = 5 V, HIZ Mode, no battery, ADC Disabled, 25°C		30	38	μA
		VBUS = 5 V, HIZ Mode, no battery, ADC Disabled, $<85^{\circ}\text{C}$		30	45	μA
I_{VBUS}	Input supply current (VBUS)	VBUS = 5 V, $V_{BAT} = 7.6$ V, converter not switching		1.5	3	mA
		VBUS = 5 V, $V_{BAT} = 7.6$ V, converter switching, $I_{SYS} = 0\text{A}$		3		mA
VBUS/VBAT POWER UP						
V_{VBUS_OP}	VBUS operating range		3.9		6.2	V
$V_{VBUS_UVLO_RISING}$	VBUS rising for active I2C, no battery	VBUS rising		3.3	3.62	V
$V_{VBUS_OV_RISING}$	VBUS over-voltage rising threshold	VBUS rising	6.2		6.6	V
	VBUS over-voltage falling threshold	VBUS falling	5.9		6.4	V
$V_{BAT_UVLO_RISING}$	Battery for active I2C	VBAT rising	3.7	4	4.42	V
$V_{POORSRC_FALLING}$	Bad adapter detection threshold	VBUS falling below $V_{POORSRC_FALLING}$		3.7		V
$I_{POORSRC}$	Bad adapter detection current source			15		mA
BATTERY CHARGER						
$V_{CELLREG_RANGE}$	Typical charge voltage regulation range		3.4		4.6	V
$V_{CELLREG_STEP}$	Typical charge voltage step			5		mV
$V_{CELL_REG_ACC}$	Charge voltage	VREG = 4.20 V, $T_J = -40^{\circ}\text{C}$ to 85°C ,	4.179	4.2	4.221	V
$V_{CELL_REG_ACC}$	Charge voltage	VREG = 4.35 V, $T_J = -40^{\circ}\text{C}$ to 85°C	4.328	4.35	4.371	V
I_{CHG_RANGE}	Charge current regulation range		100		2200	mA
I_{CHG_STEP}	Charge current regulation step			50		mA
I_{CHG_ACC}	Fast Charge current regulation accuracy	ICHG = 1000 mA, VBAT = 6.2 V or 7.6 V, $T_J = -20^{\circ}\text{C}$ to 85°C	-5.5		7.6	%
I_{CHG_ACC}	Fast Charge current regulation accuracy	ICHG = 500mA, VBAT = 6.2 V or 7.6 V, $T_J = -20^{\circ}\text{C}$ to 85°C	-11		12	%
I_{CHG_ACC}	Fast Charge current regulation accuracy	ICHG = 250 mA, VBAT = 6.2 V or 7.6 V, $T_J = -20^{\circ}\text{C}$ to 85°C	-25		25	%
I_{PRECHG_RANGE}	Precharge current range		50		800	mA
I_{PRECHG_STEP}	Typical precharge current step			50		mA
I_{PRECHG_ACC}	Precharge current accuracy	VBAT = 5.2 V, IPRECHG = 200 mA, $T_J = 25^{\circ}\text{C}$	168		232	mA
		VBAT = 5.2 V, IPRECHG = 200 mA, $T_J = 0^{\circ}\text{C}$ to 85°C	156		244	mA

Electrical Characteristics (continued)
 $V_{VBUS_UVLOZ} < V_{VBUS} < V_{VBUS_OV}$, $T_J = -40^{\circ}\text{C}$ to $+125^{\circ}\text{C}$, and $T_J = 25^{\circ}\text{C}$ for typical values (unless otherwise noted)

PARAMETER		TEST CONDITIONS	MIN	TYP	MAX	UNIT
I_{TERM_RANGE}	Termination current range		50		800	mA
I_{TERM_STEP}	Typical termination current step			50		mA
I_{TERM_ACC}	Termination current accuracy	ICHG = 1.5A, ITERM = 150 mA, $T_J = 25^{\circ}\text{C}$	139		161	mA
		ICHG = 1.5A, ITERM = 150 mA, $T_J = 0^{\circ}\text{C}$ to 85°C	120		180	mA
		ICHG = 1.5A, ITERM = 100 mA, $T_J = 25^{\circ}\text{C}$	90		110	mA
		ICHG = 1.5A, ITERM = 100 mA, $T_J = 0^{\circ}\text{C}$ to 85°C	50		130	mA
$V_{CELL_SHORT_RISING}$	Short Battery Voltage rising threshold to start pre-charging	VBAT rising	2.05	2.2	2.35	V
$V_{CELL_SHORT_FALLING}$	Short Battery Voltage falling threshold to stop pre-charging	VBAT falling	1.85	2	2.15	V
I_{BAT_SHORT}	Low Battery Voltage trickle charging current	$V_{CELL} < 2.2\text{V}$, $V_{BAT} < 4.4\text{V}$		100		mA
		$V_{CELL} < 2.2\text{V}$, $V_{BAT} > 4.4\text{V}$			200	mA
$V_{CELL_LOWV_RISING}$	VBAT LOWV Rising threshold to start fast-charging	VBAT rising, $V_{BATLOW} = 2.8\text{V}$	2.65	2.8	2.95	V
$V_{CELL_LOWV_FALLING}$	VBAT LOWV falling threshold to start fast-charging	VBAT falling, $V_{BATLOW} = 2.8\text{V}$	2.45	2.6	2.75	V
$V_{CELL_LOWV_RISING}$	VBAT LOWV rising threshold to start fast-charging	VBAT rising, $V_{BATLOW} = 6.0\text{V}$	2.85	3	3.15	V
$V_{CELL_LOWV_FALLING}$	VBAT LOWV falling threshold to start fast-charging	VBAT rising, $V_{BATLOW} = 6.0\text{V}$	2.65	2.8	2.95	V
V_{CELL_RECHG}	Recharge threshold below V_{CELL_REG}	VBAT falling, $V_{CELL_RECHG}[1:0] = 01$		100		mV
R_{ON_QHS} (Q2)	High-side switching MOSFET on-resistance between SW and SYS (Q2)	$T_J = 25^{\circ}\text{C}$		32	34.2	m Ω
		$T_J = -40^{\circ}\text{C}$ to 125°C		32	46.6	m Ω
R_{ON_QLS} (Q3)	Low-side switching MOSFET on-resistance between SW and GND (Q3)	$T_J = 25^{\circ}\text{C}$		42.7	45.8	m Ω
		$T_J = -40^{\circ}\text{C}$ to 125°C		42.7	62.9	m Ω
I_{BAT_DISCHG}	BAT Discharge current source	$V_{BAT} = 8\text{V}$, $EN_BAT_DISCHG = 1$	8	11.5	16	mA
INPUT VOLTAGE / CURRENT REGULATION						
V_{INDPM_RANGE}	Input voltage regulation range		3.9		5.5	V
V_{INDPM_STEP}	Input voltage regulation step			100		mV
V_{INDPM}	Input voltage limit	$V_{INDPM} = 3.9\text{V}$	3.783	3.9	4.017	V
		$V_{INDPM} = 4.4\text{V}$	4.268	4.4	4.532	V
I_{INDPM_RANGE}	Input current regulation range		500		3300	mA
I_{INDPM_STEP}	Input current regulation step			100		mA
I_{INDPM_ACC}	Input current regulation limit	$I_{INDPM} = 500\text{mA}$	425	462.5	500	mA
		$I_{INDPM} = 900\text{mA}$	765	832.5	900	mA
		$I_{INDPM} = 2500\text{mA}$	2125	2312.5	2500	mA
		$I_{INDPM} = 3000\text{mA}$	2550	2775	3000	mA
K_{ILIM}		$I_{INMAX} = K_{ILIM}/R_{ILIM}$, Input Current regulation by ILIM pin = 1.5A	1030	1111	1192	A x Ω
R_{ON_QBLK} (Q1)	Blocking MOSFET on-resistance between VBUS and PMID (QBLK)	$T_J = 25^{\circ}\text{C}$		34	36.2	m Ω
		$T_J = -40^{\circ}\text{C}$ to 125°C		34	50.9	m Ω
THERMAL REGULATION AND THERMAL SHUTDOWN						
T_{REG}	Junction temperature regulation accuracy	$T_{REG} = 120^{\circ}\text{C}$		120		$^{\circ}\text{C}$
T_{SHUT_RISING}	Thermal Shutdown Rising threshold	Temperature Increasing		150		$^{\circ}\text{C}$
	Thermal Shutdown Falling threshold	Temperature Decreasing		120		$^{\circ}\text{C}$

Electrical Characteristics (continued)

 $V_{V_{BUS_UVLOZ}} < V_{V_{BUS}} < V_{V_{BUS_OV}}$, $T_J = -40^{\circ}\text{C}$ to $+125^{\circ}\text{C}$, and $T_J = 25^{\circ}\text{C}$ for typical values (unless otherwise noted)

PARAMETER		TEST CONDITIONS	MIN	TYP	MAX	UNIT
JEITA THERMISTOR COMPARATOR (BOOST MODE)						
V_{T1}	TS pin voltage rising. T1 (0°C) threshold, Charge suspended below this temperature.	As Percentage to REGN	72.75	73.25	73.75	%
V_{T1_HYS}	TS pin voltage falling. Charge re-enabled to ICHG/2 and VREG above this temperature	As Percentage to REGN		1.3		%
V_{T2}	TS pin voltage rising. T2 (10°C) threshold, charge set to ICHG/2 and VREG below this temperature	As Percentage to REGN	67.75	68.25	68.75	%
V_{T2_HYS}	TS pin voltage falling. Charge set to ICHG and VREG above this temperature	As Percentage to REGN		1.2		%
V_{T3}	TS pin voltage falling. T3 (45°C) threshold, charge set to ICHG and 8.1 V above this temperature.	As Percentage to REGN	44.25	44.75	45.25	%
V_{T3_HYS}	TS pin voltage rising. Charge set to ICHG and VREG below this temperature	As Percentage to REGN		1		%
V_{T5}	TS pin voltage falling. T5 (60°C) threshold, charge suspended above this temperature.	As Percentage to REGN	33.875	34.375	34.875	%
V_{T5_HYS}	TS pin voltage rising. Charge set to ICHG and 8.1 V below this temperature	As Percentage to REGN		1.35		%
BOOST MODE CONVERTER						
F_{SW}	PWM switching frequency	Oscillator frequency	1.35	1.5	1.65	MHz
CELL BALANCING						
I_{CB_MAX}	Maximum recommended cell balancing current	$V_{CELL} = 4.2\text{V}$, $RCBSET = 13\Omega$, $RDSON_QCBX = 1\Omega$			300	mA
R_{DSON_QCBH}	MOSFET on resistance between BAT and MID	Cell balance enabled (REG0x2A[0] = 1); $V_{CELL_HS} > 3.7\text{V}$, $V_{CELL_LS} > V_{CELL_HS}$, $V_{CELL_LS} - V_{BAT} - V_{MID} - V_{MID} > 80\text{mV}$, $ICB \leq 300\text{mA}$		1	TBD	Ω
R_{DSON_QCBL}	MOSFET on resistance between MID and GND	Cell balance enabled (REG0x2A[0] = 1); $V_{CELL_LS} > 3.7\text{V}$, $V_{CELL_LS} > V_{CELL_HS}$, $V_{MID} - (V_{BAT} - V_{MID}) > 80\text{mV}$, $ICB \leq 300\text{mA}$		1	TBD	Ω
V_{CBEN_RISING}	Cell balance function qualification threshold	Cell balance enabled rising threshold	3.65	3.7	3.75	V
V_{CBEN_HYS}	Cell balance function qualification hysteresis	Cell balance enabled falling hysteresis		200		mV
$V_{QUAL_TH_RANGE}$	Cell balance pre-qualification mode to qualification mode threshold range	Cell balance enabled (REG0X2A[0]=1); V_{CELL_LS} or $V_{CELL_HS} > 3.7\text{V}$, increase the voltage delta between the two cells	40		180	mV
$V_{QUAL_TH_STEP}$	Cell balance pre-qualification mode to qualification mode threshold step size	Cell balance enabled (REG0X2A[0]=1); V_{CELL_LS} or $V_{CELL_HS} > 3.7\text{V}$, increase the voltage delta between the two cells		10		mV
V_{QUAL_TH}	Cell balance pre-qualification mode to qualification mode threshold.	Cell balance enabled (REG0X2A[0]=1); V_{CELL_LS} or $V_{CELL_HS} > 3.7\text{V}$, increase the voltage delta between the two cells		80		mV
$V_{DIFF_START_RANGE}$	Balance discharge start cell voltage difference threshold range	Cell balance enabled (REG0x2A[0] = 1); Difference between the two cells to turn on cell balancing MOSFET	40		190	mV
$V_{DIFF_START_STEP}$	Balance discharge start cell voltage difference threshold step size	Cell balance enabled (REG0x2A[0] = 1); Difference between the two cells to turn on cell balancing MOSFET		10		mV

Electrical Characteristics (continued)
 $V_{\text{VBUS_UVLOZ}} < V_{\text{VBUS}} < V_{\text{VBUS_OV}}$, $T_J = -40^{\circ}\text{C}$ to $+125^{\circ}\text{C}$, and $T_J = 25^{\circ}\text{C}$ for typical values (unless otherwise noted)

PARAMETER		TEST CONDITIONS	MIN	TYP	MAX	UNIT
$V_{\text{DIFF_START}}$	Balance discharge start cell voltage difference threshold	Cell balance enabled (REG0x2A[0] = 1); Difference between the two cells to turn on cell balancing MOSFET set to 120mV (REG0x29[3:0] = 0110)		120		mV
$V_{\text{DIFF_START}}$	Balance discharge start cell voltage difference threshold	Cell balance enabled (REG0x2A[0] = 1); Difference between the two cells to turn on cell balancing MOSFET set to 80mV (REG0x29[3:0] = 0100)		80		mV
$V_{\text{DIFF_END_RANGE}}$	Balance discharge stop cell voltage difference threshold range	Cell balance enabled (REG0x2A[0] = 1); Difference between the two cells to turn off cell balancing MOSFET	30		100	mV
$V_{\text{DIFF_END_STEP}}$	Balance discharge stop cell voltage difference threshold step size	Cell balance enabled (REG0x2A[0] = 1); Difference between the two cells to turn off cell balancing MOSFET		10		mV
$V_{\text{DIFF_END}}$	Balance discharge stop cell voltage difference threshold	Cell balance enabled (REG0x2A[0] = 1); Difference between the two cells to turn off cell balancing MOSFET set to (REG0x29[3:0] = 0110, REGx28[7:5]=010)		70		mV
$V_{\text{DIFF_END}}$	Balance discharge stop cell voltage difference threshold	Cell balance enabled (REG0x28[7] = 1); Difference between the two cells to turn off cell balancing MOSFET set to 45mV (REG0x29[3:0] = 0100, REGx28[7:5]=001)		40		mV
$V_{\text{CELL_OVP_RISING}}$	Cell over voltage rising threshold	VCELL rising, as percentage of VCELLREG	103	104	105	%
$V_{\text{CELL_OVP_FALLING}}$	Cell over voltage falling threshold	VCELL rising, as percentage of VCELLREG	101	102	103	%
$I_{\text{QCBX_OC}}$	Cell Balance MOSFET over-current protection	ICB > 500mA	400	500	600	mA
$I_{\text{MID_BIAS}}$	MID pin bias current	Voltage difference between the two battery cells \leq 400mV			10	μ A
REGN LDO						
V_{REGN}	REGN LDO output voltage	$V_{\text{VBUS}} = 5\text{ V}$, $I_{\text{REGN}} = 20\text{ mA}$	4.7	4.8		V
I_{REGN}	REGN LDO current limit	$V_{\text{VBUS}} = 5\text{ V}$, $V_{\text{REGN}} = 3.8\text{ V}$	50			mA
Analog-to-Digital Converter (ADC)						
$t_{\text{ADC_CONV}}$	Conversion time, each measurement	ADC_SAMPLE[1:0] = 11		24		ms
		ADC_SAMPLE[1:0] = 10		12		ms
		ADC_SAMPLE[1:0] = 01		6		ms
		ADC_SAMPLE[1:0] = 00		3		ms
ADCRES	Effective resolution	ADC_SAMPLE[1:0] = 11	14	15		bits
		ADC_SAMPLE[1:0] = 10	13	14		bits
		ADC_SAMPLE[1:0] = 01	12	13		bits
		ADC_SAMPLE[1:0] = 00	10	12		bits
ADC MEASUREMENT RANGES AND LSB						
$I_{\text{BUS_ADC_RANGE}}$	ADC BUS current range		0		4	A
$I_{\text{BUS_ADC_LSB}}$	ADC BUS current LSB			1		mA
$I_{\text{BAT_ADC_RANGE}}$	ADC BAT current range		0		4	A
$I_{\text{BAT_ADC_LSB}}$	ADC BAT current LSB			1		mA
$V_{\text{BUS_ADC_RANGE}}$	ADC BUS voltage range		0		6.5	V
$V_{\text{BUS_ADC_LSB}}$	ADC BUS voltage LSB			1		mV
$V_{\text{BAT_ADC_RANGE}}$	ADC BAT voltage range		0		10	V
$V_{\text{BAT_ADC_LSB}}$	ADC BAT voltage LSB			1		mV
$V_{\text{CELLTOP_ADC_RANGE}}$	ADC MID voltage range		0		5	V

Electrical Characteristics (continued)

 $V_{VBUS_UVLOZ} < V_{VBUS} < V_{VBUS_OV}$, $T_J = -40^{\circ}\text{C}$ to $+125^{\circ}\text{C}$, and $T_J = 25^{\circ}\text{C}$ for typical values (unless otherwise noted)

PARAMETER		TEST CONDITIONS	MIN	TYP	MAX	UNIT
$V_{CELLTOP_ADC_LSB}$	ADC MID voltage LSB			1		mV
$V_{CELLBOT_ADC_RANGE}$	ADC MID voltage range		0		5	V
$V_{CELLBOT_ADC_LSB}$	ADC MID voltage LSB			1		mV
$V_{TS_ADC_RANGE}$	ADC TS voltage range		20		80	%
$V_{TS_ADC_LSB}$	ADC TS voltage LSB			0.098		%
$V_{TDIE_ADC_RANGE}$	ADC Die temperature range		0		150	$^{\circ}\text{C}$
$V_{TDIE_ADC_LSB}$	ADC Die temperature LSB			0.5		$^{\circ}\text{C}$
I2C INTERFACE (SCL, SDA)						
V_{IH}	Input high threshold level, SDA and SCL	Pull-up rail 1.8 V	1.3			V
V_{IL}	Input low threshold level	Pull-up rail 1.8 V			0.4	V
V_{OL}	Output low threshold level	Sink current = 5 mA			0.4	V
I_{BIAS}	High level leakage current	Pull-up rail 1.8 V			1	μA
LOGIC I/O PIN ($\overline{\text{CE}}$, PSEL)						
V_{IH}	Input high threshold level		1.3			V
V_{IL}	Input low threshold level				0.4	V
I_{IN_BIAS}	High level leakage current	Pull-up rail 1.8 V			1	μA
LOGIC O PIN ($\overline{\text{INT}}$, $\overline{\text{PG}}$, STAT)						
V_{OL}	Output low threshold level	Sink current = 5 mA			0.4	V
I_{OUT_BIAS}	High level leakage current	Pull-up rail 1.8 V			1	μA

7.6 Timing Requirements

PARAMETER		TEST CONDITIONS	MIN	NOM	MAX	UNIT
VBUS/BAT POWER UP						
t_{VBUS_OV}	VBUS OVP reaction time	VBUS rising above V_{VBUS_OV} threshold to converter turn off		200		ns
$t_{POORSRC}$	Bad adapter detection duration			30		ms
BATTERY CHARGER						
t_{TERM_DGL}	Deglitch time for charge termination	Charge current falling below I_{TERM}		250		ms
t_{RECGH_DGL}	Deglitch time for recharge threshold	BAT voltage falling below $V_{RECHG} = 100$ mV		250		ms
$t_{BAT_OVP_DGL}$	Deglitch time for battery over-voltage to disable charge			1		μs
t_{TOP_OFF}	Typical Top-Off Timer Accuracy	$TOP_OFF_TIMER[1:0] = 30$ min	24	30	36	min
t_{SAFETY}	Charge Safety Timer Accuracy	$CHG_TIMER[1:0] = 12$ hours	10.8	12	13.2	hr
I2C INTERFACE						
f_{SCL}	SCL clock frequency				1000	KHZ
DIGITAL CLOCK AND WATCHDOG TIMER						
f_{LPDIG}	Digital low power clock	REGN LDO disabled	18	30	45	KHZ
f_{DIG}	Digital clock	REGN LDO enabled	1.35	1.5	1.65	MHZ
t_{WDT}	Watchdog Reset time	WATCHDOG[1:0] = 160 s, REGN LDO disabled	100	160		sec
t_{WDT}	Watchdog Reset time	WATCHDOG[1:0] = 160 s, REGN LDO enabled	136	160		sec

7.7 Typical Characteristics

$C_{VBUS} = 1\mu\text{F}$, $C_{PMID} = 10\mu\text{F}$, $C_{SYS} = 44\mu\text{F}$, $C_{BAT} = 10\mu\text{F}$, $L = 1\mu\text{H}$ (DFE252012F-1R0) (unless otherwise specified)

ADVANCE INFORMATION

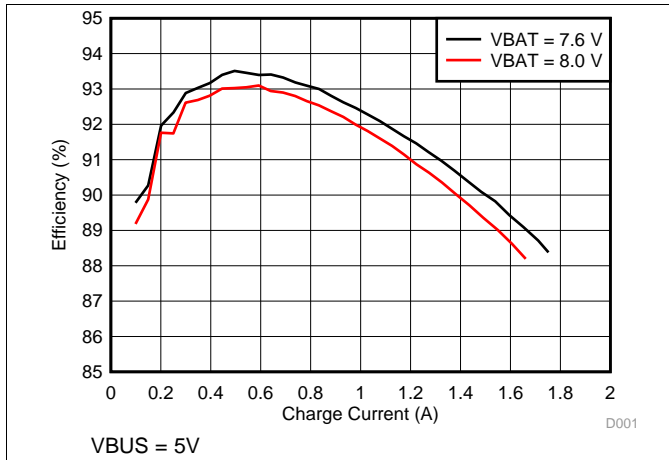

Figure 1. Charge Efficiency vs. Charge Current

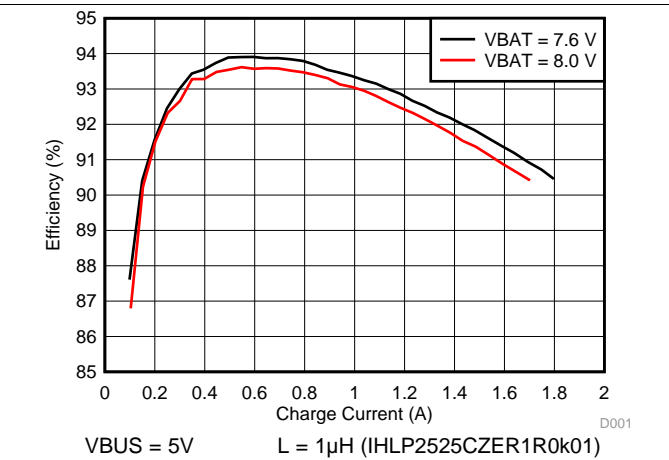

Figure 2. Charge Efficiency vs. Charge Current

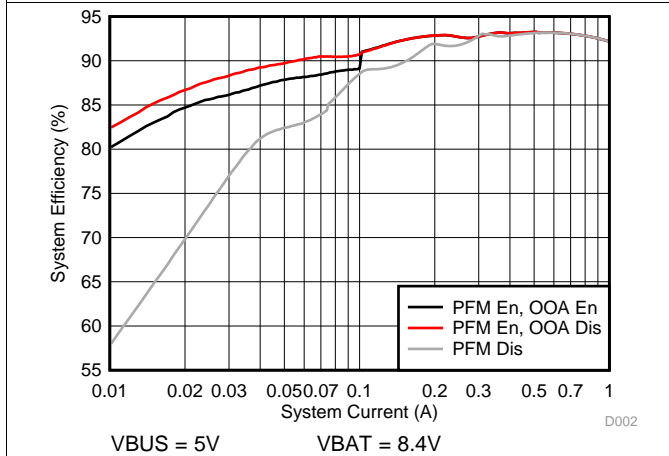

Figure 3. System Efficiency vs. System Current

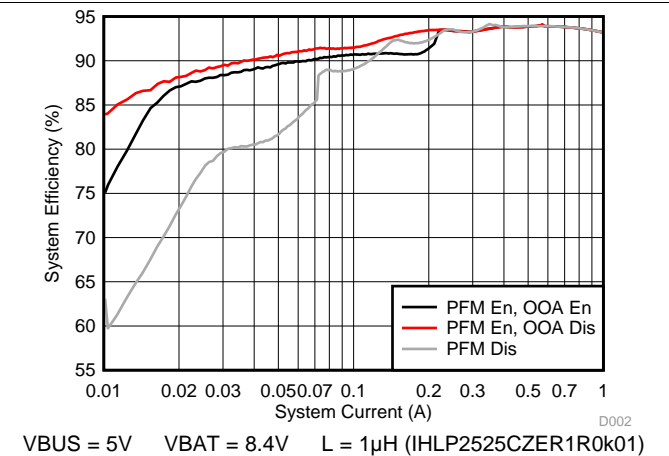

Figure 4. System Efficiency vs. System Current

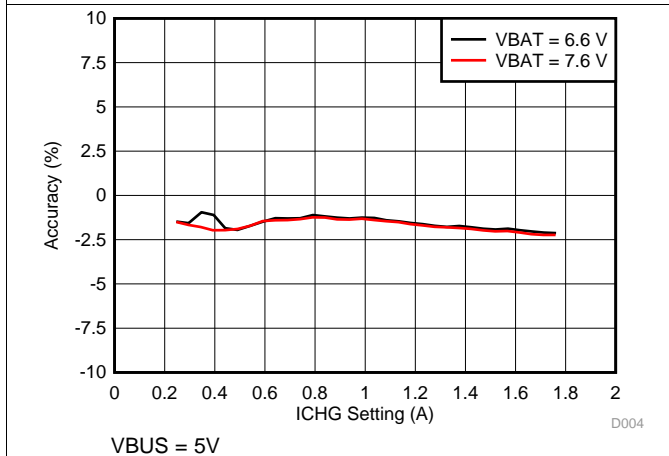

Figure 5. Charge Current Accuracy vs. ICHG Setting

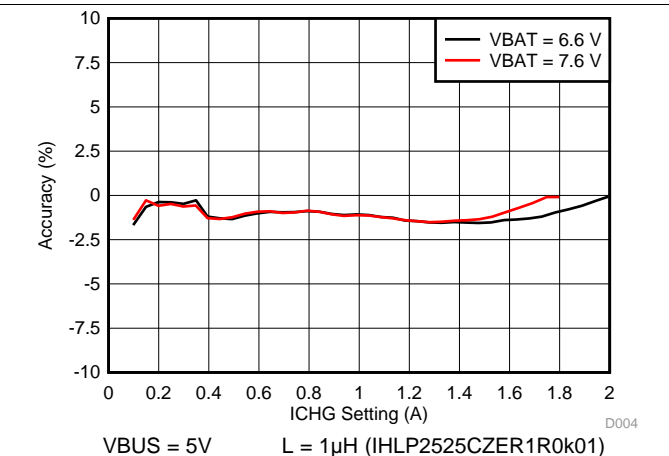
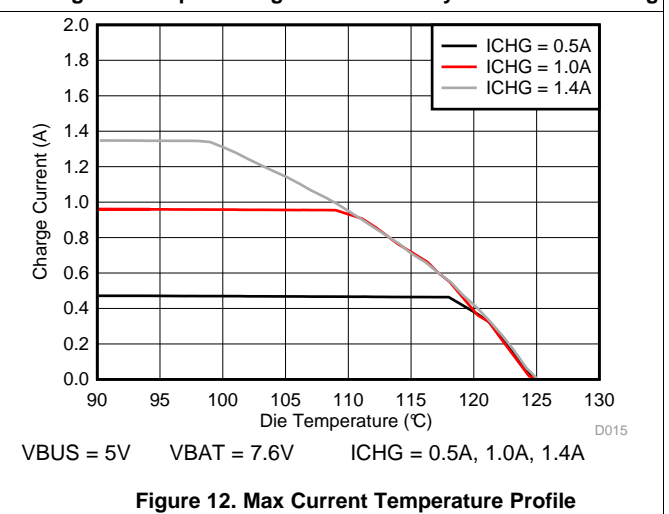
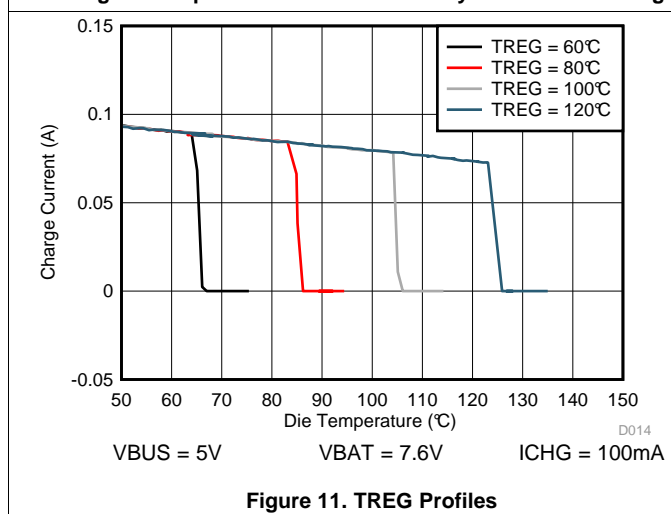
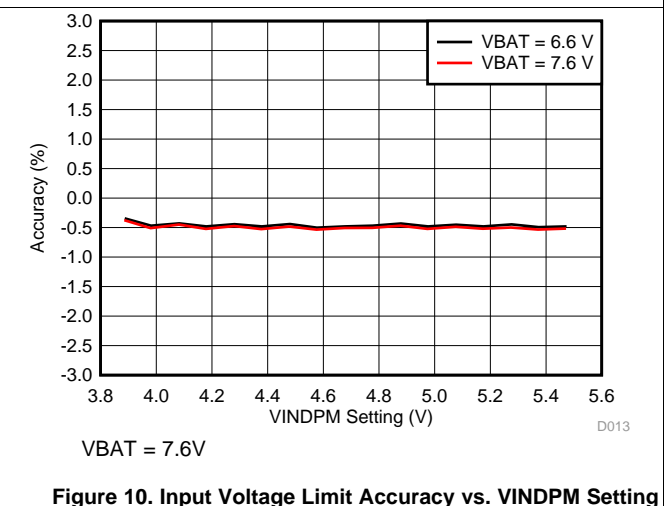
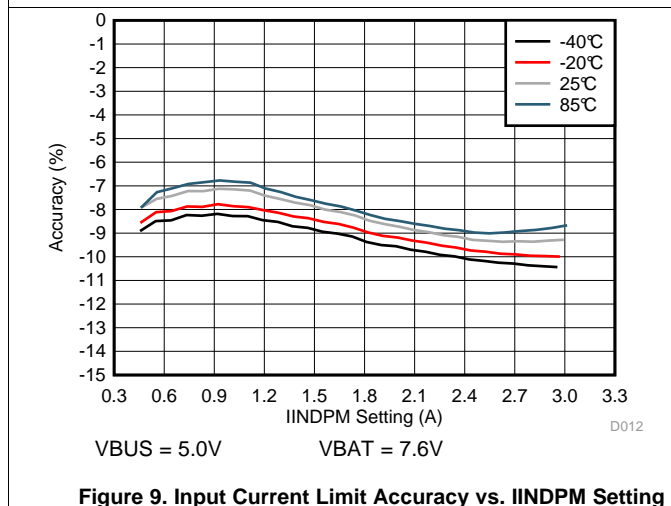
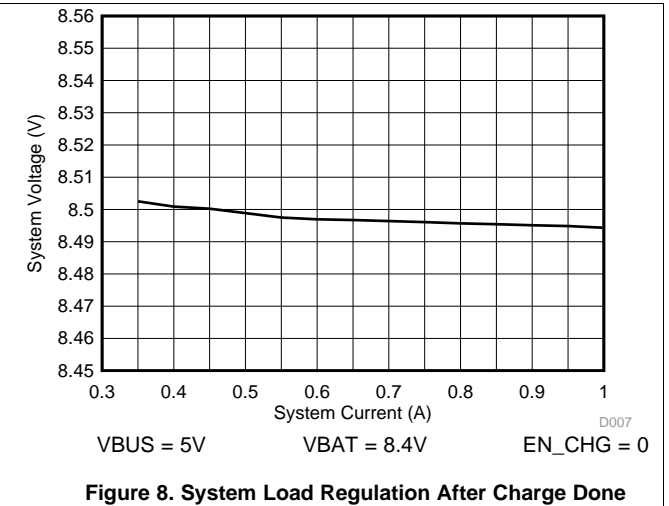
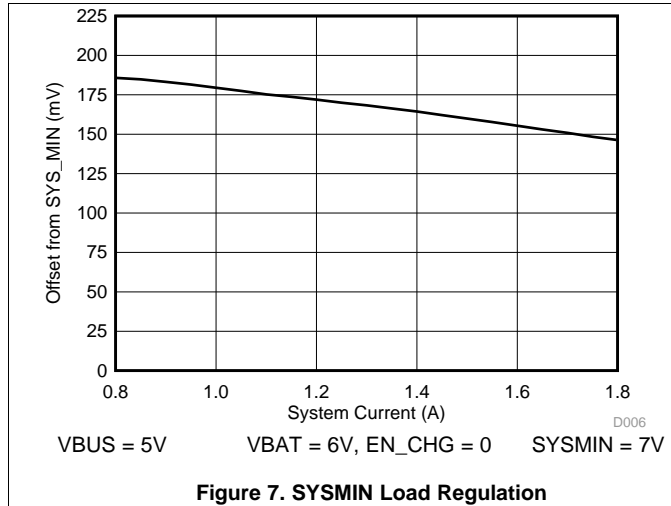

Figure 6. Charge Current Accuracy vs. ICHG Setting

Typical Characteristics (continued)

$C_{VBUS} = 1\mu\text{F}$, $C_{PMID} = 10\mu\text{F}$, $C_{SYS} = 44\mu\text{F}$, $C_{BAT} = 10\mu\text{F}$, $L = 1\mu\text{H}$ (DFE252012F-1R0) (unless otherwise specified)



ADVANCE INFORMATION

8 Detailed Description

8.1 Overview

The BQ25887 device is a highly integrated 2-A switch-mode battery charger for 2s Li-Ion and Li-Polymer battery. It integrates the input blocking FET (Q1, QBLK), high-side switching FET (Q2, QHS), and low-side switching FET (Q3, QLS). The device also integrates the boot-strap diode for high-side gate drive.

8.2 Functional Block Diagram

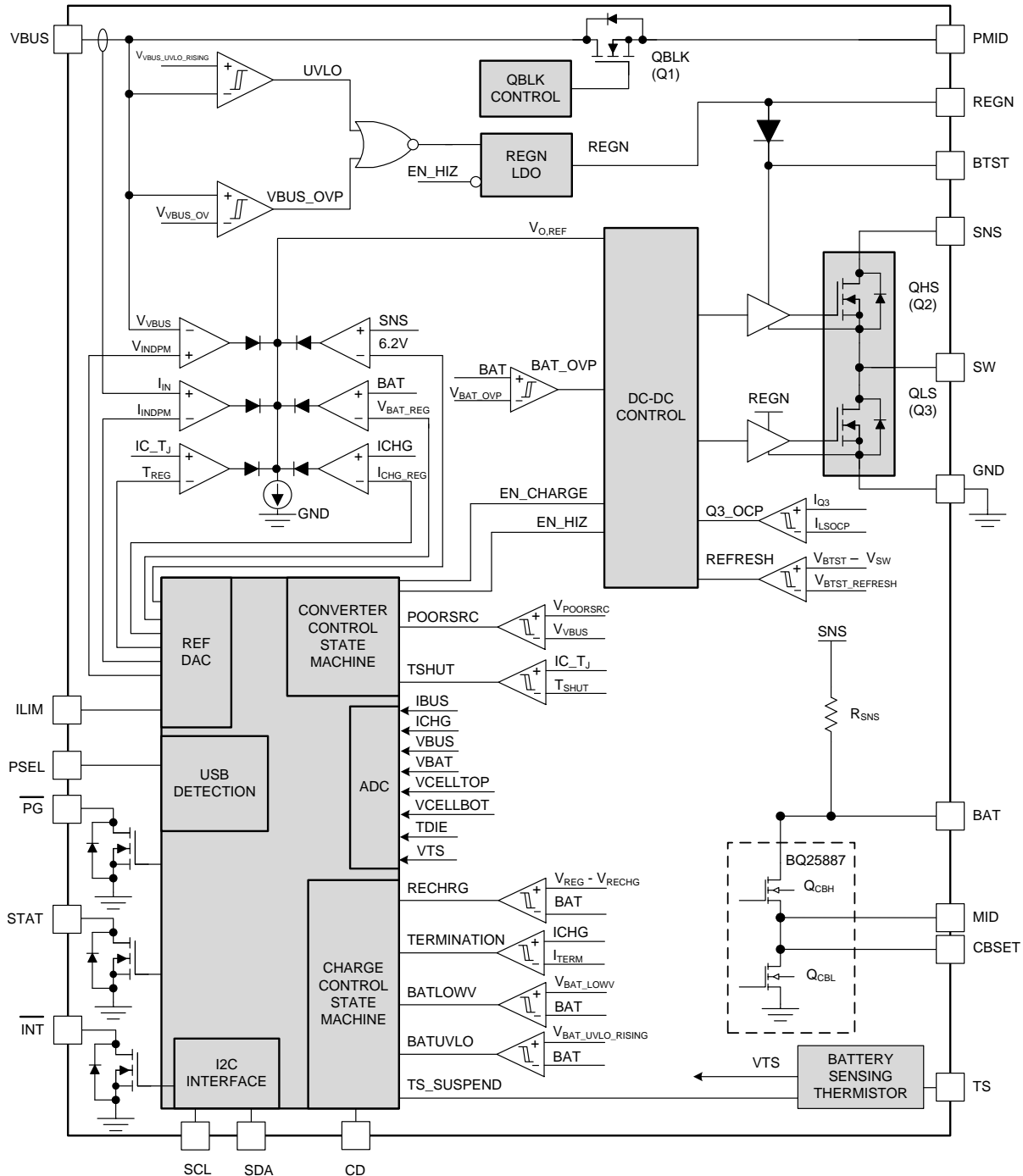

ADVANCE INFORMATION

8.3 Feature Description

8.3.1 Device Power-On-Reset

The internal bias circuits are powered from either VBAT or VBUS when it rises above $V_{VBUS_UVLO_RISING}$ or $V_{BAT_UVLO_RISING}$. I2C interface is ready for communication and all the registers are reset to default value. The host can access all the registers after POR.

8.3.2 Device Power Up from Input Source

When an input source is plugged in, the device checks the input source voltage to turn on REGN LDO and all the bias circuits. It detects and sets the input current limit before the boost converter is started. The power up sequence from input source is as listed:

1. Poor Source Qualification
2. Input Source Type Detection based on PSEL to set default Input Current Limit (IINDPM) register and input source type
3. Power Up REGN LDO
4. Converter Power-up

8.3.2.1 Poor Source Qualification

After REGN LDO powers up, the device checks the current capability of the input source. The input source has to meet the following requirements in order to start the boost converter.

1. VBUS voltage below V_{VBUS_OVP}
2. VBUS voltage above $V_{POORSRC}$ when pulling $I_{POORSRC}$ (typical 30mA)

If V_{BUS_OVP} is detected (condition 1 above), the device automatically retries detection once the over-voltage fault goes away. If a poor source is detected (condition 2 above), the device repeats poor source qualification routine every 2 seconds. After 7 consecutive failures, the device sets $VBUS_STAT[2:0] = '0b100'$, $EN_HIZ = 1$, and goes to HIZ mode. On BQ25887 adapter re-plug-in and/or EN_HIZ bit toggle is required to restart device operation. The EN_HIZ bit is cleared automatically when the adapter is plugged in. If the fault is not removed, the part will enter HIZ mode again after the 7 consecutive failures.

8.3.2.2 Input Source Type Detection

After the PG_STAT bit is set and input source is qualified, the charger device runs input source type detection when $AUTO_INDET_EN$ bit is set.

The BQ25887 sets input current limit through PSEL pin. After input source type detection, the following registers and pins are changed:

1. Input Current Limit (IINDPM) register is changed to set current limit
2. Input Voltage Limit (VINDPM) register is changed to set default limit (if $EN_VINDPM_RST = 1$, otherwise VINDPM value remains unchanged)
3. $VBUS_STAT$ bits change to reflect the detected source
4. \overline{INT} pin pulses to notify the host
5. \overline{PG} pin is pulled LOW, and PG_STAT bit is set to '1'

After detection is completed, the host can over-write IINDPM or VINDPM registers to change the input current, or input voltage limit if needed. The charger input current is always limited by the lower of IINDPM register, ILIM pin, or Input Current Optimizer (ICO) setting when ICO is enabled.

When $AUTO_INDET_EN$ is disabled, the Input Source Type Detection is bypassed, and the Input Current Limit (IINDPM) register remains unchanged from previous value. When EN_VINDPM_RST is disabled, the Input Current Limit (VINDPM) register remains unchanged from previous value.

8.3.2.2.1 PSEL Sets Input Current Limit

The BQ25887 has PSEL pin for input current limit setting to interface with USB PHY. It directly takes the USB PHY device output to decide whether the input is USB host or charging port. PSEL HIGH sets the input current limit to 500mA and PSEL LOW sets the input current limit to 3A. Automatic start ICO is disabled when PSEL is LOW. When no input source is connected, input current limit will not be updated by PSEL change.

Feature Description (continued)

During default mode, after input source type detection is completed with an input source already plugged in, the PSEL pin is monitored. When the pin status changes, the input current limit is changed based on the pin status.

During host mode, after input source type detection is completed with an input source already plugged in, the PSEL pin is NOT monitored. The host needs to set the FORCE_INDET bit to 1 in order to read the PSEL value. After the detection is completed, the input current limit (IINDPM), and the VBUS_STAT bits can be changed due to the detection result.

8.3.2.2 Force Input Current Limit Detection

In host mode, the host can force the device to run Input Current Limit Detection by setting FORCE_INDET bit. After the detection is completed, FORCE_INDET bit returns to 0 by itself and input result is updated.

8.3.2.3 Power up REGN Regulator (LDO)

The REGN LDO supplies internal bias circuits as well as the QHS and QLS gate drive. The LDO also provides bias rail to TS external resistors. The pull-up rail of STAT and PG can be connected to REGN as well. The REGN is enabled when all the below conditions are valid.

1. VBUS above $V_{VBUS_UVLO_RISING}$ in boost mode or VBUS below $V_{VBUS_UVLO_RISING}$ in buck mode
2. Poor Source Qualification detects a valid input source
3. Input Source Type Detection completes and sets appropriate input current limit
4. After 220 ms delay is complete

If one of the above conditions is not valid, the device is in high impedance mode (HIZ) with REGN LDO off. The device draws less than I_{VBUS_HIZ} from VBUS during HIZ state. The battery powers up the system when the device is in HIZ.

8.3.2.4 Converter Power Up

After the input current limit is set, the \overline{PG} pin is pulled LOW, the PG_STAT and VBUS_STAT bits are changed, and the converter is enabled, allowing the HSFET and LSFET to start switching. The device provides soft-start when converter output voltage is ramped up.

Before charging begins, the battery discharge source (IBAT_DISCHG) is enabled automatically to detect the presence of battery. The host can enable IBAT_DISCHG via the EN_BAT_DISCHG bit at any point during operation, including in Battery Only or HIZ modes.

As a battery charger, the device deploys a highly efficient 1.5 MHz boost switching regulator. The fixed frequency oscillator keeps tight control of the switching frequency under all conditions of input voltage, battery voltage, charge current and temperature, simplifying output filter design.

In order to improve light-load efficiency, the device switches to PFM (Pulse Frequency Modulation) control at light load when battery is below minimum system voltage setting or charging is disabled. During the PFM operation, the switching duty cycle is set by the ratio of SNS and VBUS.

8.3.3 Input Current Optimizer (ICO)

The device provides innovative Input Current Optimizer (ICO) to identify maximum power point without overloading the input source. The algorithm automatically identifies maximum input current limit of a power source without staying in VINDPM to avoid input source overload.

On BQ25887, this feature is enabled by default (EN_ICO=1) and can be disabled by setting EN_ICO bit to 0. After DCP type input source is detected based on the procedures describe above (Input Source Type Detection). The algorithm runs automatically when EN_ICO bit is set. The algorithm can also be forced to execute by setting FORCE_ICO bit regardless of input source type detected .

Feature Description (continued)
Table 2. Input Current Optimizer Automatic Operation

DEVICE	INPUT SOURCE	INPUT CURRENT LIMIT (IINDPM)	AUTOMATIC START ICO ALGORITHM
BQ25887	PSEL = HI	500mA	Disable
	PSEL = LOW	3.0A	Enable

The actual input current limit used by the Dynamic Power Management is reported in ICO_ILIM register while Input Current Optimizer is enabled (EN_ICO = 1) or set by IINDPM register when the algorithm is disabled (EN_ICO=0). In addition, the current limit is clamped by ILIM pin unless EN_ILIM bit is 0 to disable ILIM pin function.

When the algorithm is enabled, it runs continuously to adjust input current limit of Dynamic Power Management (IINDPM) using ICO_ILIM register until ICO_STAT[1:0] and ICO_FLAG bits are set (the ICO_FLAG bit indicates any change in ICO_STAT[1:0] bits). The algorithm operates depending on battery voltage:

1. When voltage at BAT pin is below 6.2V, the algorithm starts ICO_ILIM register with IINDPM which is the maximum input current limit allowed by system
2. When voltage at BAT is above 6.2V, the algorithm starts ICO_ILIM register with 500mA which is the minimum input current limit to minimize adapter overload

When optimal input current is identified, the ICO_STAT[1:0] and ICO_FLAG bits are set to indicate input current limit in ICO_ILIM register would not be changed until the algorithm is forced to run by the following event (these events also reset the ICO_STAT[1:0] bits to '01'):

1. A new input source is plugged-in, or EN_HIZ bit is toggled
2. IINDPM register is changed
3. VINDPM register is changed
4. FORCE_ICO bit is set to 1
5. VBUS_OVP event

8.3.4 Battery Charging Management

The BQ25887 charges 2-cell Li-Ion battery with up to 2.2-A charge current for high capacity battery.

8.3.4.1 Autonomous Charging Cycle

When battery charging is enabled (EN_CHG = 1 and CD pin is LOW;), the device autonomously completes a charging cycle without host involvement. The device default charging parameters are listed in Table below. On BQ25887, the host can always control the charging operation and optimize the charging parameters by writing to the corresponding registers through I²C.

Table 3. Charging Parameter Default Settings

DEFAULT MODE	BQ25887
Charging Voltage	4.2V/Cell
Charging Current	1.50A
Pre-Charge Current	150mA
Termination Current	150mA
Temperature Profile	JEITA
Safety Timer	12 hours
Topoff Timer	Disabled

A new charge cycle starts when the following conditions are valid:

- Converter starts
- Battery charging is enabled by I2C register bit (EN_CHG = 1 and CD pin is LOW and ICHG register is not 0 mA)
- No thermistor fault on TS
- No safety timer fault

The charger device automatically terminates the charging cycle when the charging current is below termination threshold, charge voltage is above recharge threshold, and device is not in DPM mode or thermal regulation. When a full battery voltage is discharged below recharge threshold (threshold selectable via VCELL_RECHG[1:0] bits on BQ25887), the device automatically starts a new charging cycle. After the charge is done, toggle CD pin or EN_CHG bit can initiate a new charging cycle.

The STAT output indicates the charging status of: charging (LOW), charging complete or charge disable (HIGH) or charging fault (Blinking). The STAT output can be disabled by setting STAT_DIS bit. In addition, the status register (CHRG_STAT) indicates the different charging phases as:

- 000 – Not Charging
- 001 – Trickle Charge ($V_{BAT} < V_{BAT_SHORT}$)
- 010 – Pre-charge ($V_{BAT_SHORT} < V_{BAT} < V_{BAT_LOWV}$)
- 011 – Fast-charge (CC mode)
- 100 – Taper Charge (CV mode)
- 101 – Top-off Timer Charging
- 110 – Charge Termination Done

When the charger transitions to any of these states, including when charge cycle is completed, an \overline{INT} is asserted to notify the host.

8.3.4.2 Battery Charging Profile

The device charges the battery in five phases: trickle charge, pre-charge, constant current, constant voltage, and top-off timer charging (optional). At the beginning of a charging cycle, the device checks the battery voltage and regulates current/voltage accordingly.

Table 4. Default Charging Current Setting

VBAT	CHARGING CURRENT	REGISTER DEFAULT SETTING	CHRG_STAT
$< V_{CELL_SHORT}$	I_{BAT_SHORT}	100 mA	001
$V_{CELL_SHORT} - V_{CELL_LOWV}$	I_{PRECHG}	150 mA	010
$> V_{CELL_LOWV}$	I_{CHG}	1500 mA	011

If the charger device is in DPM regulation or thermal regulation during charging, the actual charging current will be less than the programmed value. In this case, termination is temporarily disabled and the charging safety timer is counted at half the clock rate, as explained in the *Charging Safety Timer* section.

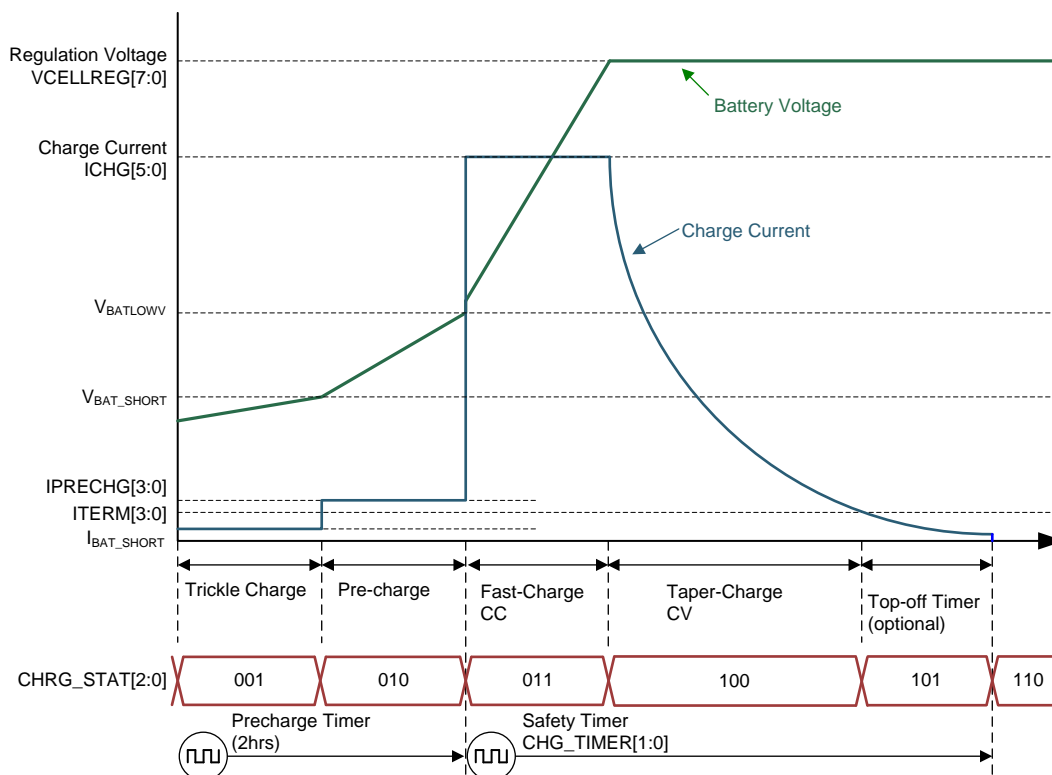

Figure 13. Battery Charging Profile

8.3.4.3 Cell Balancing During Charging

Some applications require cell balancing when the user can replace one or both of the cells in the 2S1P configuration. When charging two batteries with different voltages, cell balancing is required, as the cell with the higher voltage is at risk of being overcharged. For extremely unbalanced cells, charging the lower voltage cell as well as fast cell balancing is desired.

The BQ25887 implements a passive cell balancing scheme with a recommended maximum discharge current of 400mA. Balancing current is limited by external resistors placed between the CBSET pin and the mid-point of the two cells. Low side cell voltage is sensed at MID pin. Cell balancing can be enabled in the I2C registers.

The Cell Balancing current limit resistor, R_{CBSET} , can be calculated as below.

$$I_{CB_LIM} = V_{CELLREG} / (R_{CBSET} + R_{DSON_QCBX})$$

For example, the maximum recommended cell balancing current is 400mA. For 4.2V battery cell, R_{CBSET} can be calculated as 9.5Ω (typical).

Cell balancing status register, CB_STAT, HS_CV_STAT and LS_CV_STAT is active in both automatic cell balancing mode and manual cell balancing mode.

The default setting of the cell balancing parameters are below.

Table 5. Cell Balancing Default setting

PARAMETER	REGISTER	DEFAULT VALUE
Enable Auto Cell Balancing Mode (CB_AUTO_EN)	REG0x2A [6]	1 = Enable

Table 5. Cell Balancing Default setting (continued)

PARAMETER	REGISTER	DEFAULT VALUE
Disable Charge for Accurate Cell Balancing Measurement (CB_CHG_DIS)	REG0x2A [7]	1 = Charge Disable for Cell Balancing Voltage Measurement
Voltage Threshold Enter Cell Balancing Qualification Mode from Pre-Qualification Mode (VQUAL_TH)	REG0x29h [7:4]	1111 = Disable Pre-Qualification Mode
Voltage Threshold Enter Cell Balancing Active Mode from Qualification Mode (VDIFF_START)	REG0x29h [3:0]	0100 = 80mV
Voltage Threshold Exit Cell Balancing Offset from VDIFF_START (VDIFF_END_OFFSET)	REG0x28 [7:5]	001 = 40mV
Time Interval between Taking Measurements in Pre-Qualification Mode (TCB_QUAL_INTERVAL)	REG0x0x28 [4]	0 = 2 min
Time Interval between Taking Measurements in Cell Balancing Active Mode (TCB_ACTIVE)	REG0x28 [3:2]	10 = 2 min
Time Delay between Charge Disable and Cell Voltage Measurement (TSETTLE)	REG0x28 [1]	10 = 1 sec

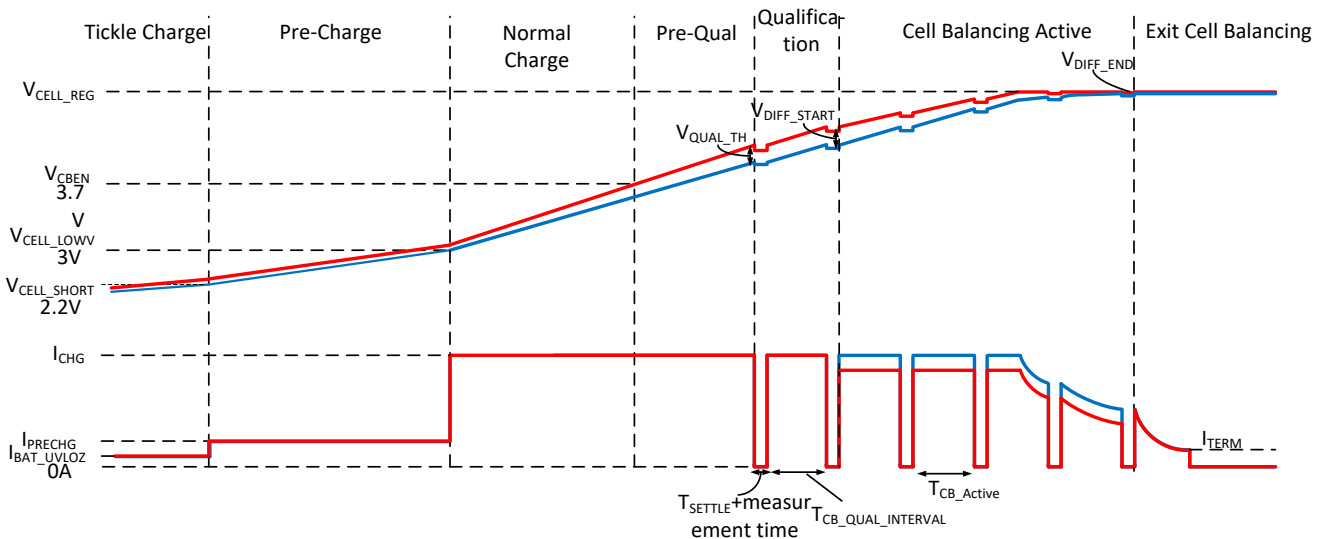

Figure 14. Cell Balancing Timing Diagram

8.3.4.4 Charging Termination

The device terminates a charge cycle when the battery voltage is above recharge threshold, and the current is below termination current.

When termination occurs, the STAT pin goes HIGH (charge current will continue to taper if top-off timer is enabled), status register CHRГ_STAT is set to 110, and an INT pulse is asserted to the host. Termination is temporarily disabled when the charger device is in input current, voltage or thermal regulation. Termination can be permanently disabled by writing 0 to EN_TERM bit prior to charge termination.

At low termination currents (50mA-100mA), due to the comparator offset, the actual termination current may be up to 20% higher than the termination target. In order to compensate for comparator offset, a programmable top-off timer (default disabled) can be applied after termination is detected. The top-off timer will follow safety timer constraints, such that if safety timer is suspended, so will the top-off timer. Similarly, if safety timer is doubled, so will the top-off timer. CHRГ_STAT reports whether the top off timer is active via the 101 code. Once the Top-Off timer expires, the CHRГ_STAT register is set to 110 and an INT pulse is asserted to the host.

Top-off timer gets reset (set to 0 and counting resumes when appropriate) for any of the following conditions:

1. Charge disable to enable

ADVANCE INFORMATION

2. Termination status low to high
3. REG_RST register bit is set (disables top-off timer)

The top-off timer settings are read in once termination is detected by the charger. Programming a top-off timer value after termination will have no effect unless a recharge cycle is initiated. An INT is asserted to the host when entering top-off timer segment as well as when top-off timer expires. All charge cycle related INT pulses (including top-off timer INT pulses) can be masked by CHRGMASK bit.

8.3.4.5 Thermistor Qualification

The charger device provides a single thermistor input for battery temperature monitor.

8.3.4.5.1 JEITA Guideline Compliance in Charge Mode

To improve the safety of charging Li-ion batteries, JEITA guideline was released on April 20, 2007. The guideline emphasized the importance of avoiding a high charge current and high charge voltage at certain low and high temperature ranges.

To initiate a charge cycle, the voltage on TS pin must be within the VT1 to VT5 thresholds. If TS voltage exceeds the T1-T5 range, the controller suspends charging and waits until the battery temperature is within the T1 to T5 range. At cool temperature (T1-T2), JEITA recommends the charge current to be reduced to half of the charge current or lower. At warm temperature (T3-T5), JEITA recommends charge voltage less than 4.1V / cell.

On BQ25887, the charger provides flexible voltage/current settings beyond JEITA requirement. The Voltage setting at warm temperature (T3-T5) can be VCELLREG, 4.0V, 4.15V, or charge suspended (configured by JEITA_VSET [1:0]). The fast charge current setting at warm temperature (T3-T5) can be 100%, or 40% of fast charge current, ICHG (configured by JEITA_ISETH). The fast charge current setting at cool temperature (T1-T2) can be 100%, 40%, or 20% of fast charge current, ICHG, or charge suspend (configured by JEITA_ISETC[1:0]). Whenever the charger detects "warm" or "cool" temperature, termination is automatically disabled regardless of JEITA_VSET, JEITA_ISETH and JEITA_ISETC register bit settings.

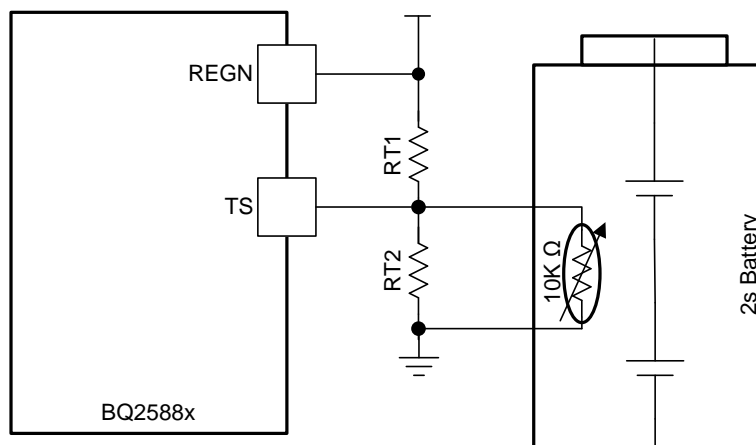

Figure 15. TS Resistor Network

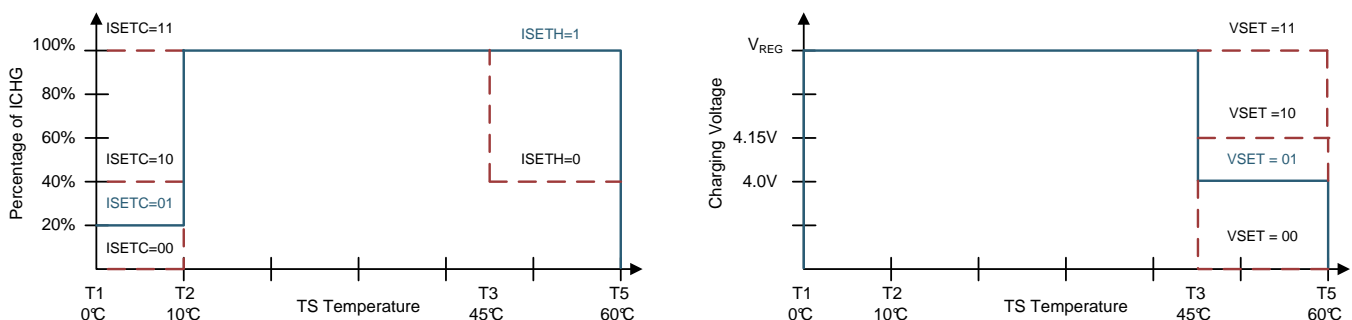

Figure 16. TS Charging Values

ADVANCE INFORMATION

Assuming a 103AT NTC (Negative Temperature Coefficient) thermistor on the battery pack as shown above, the value of RT1 and RT2 can be determined by:

$$RT2 = \frac{R_{NTC,T1} \times R_{NTC,T5} \times \left(\frac{1}{V_{T5}} - \frac{1}{V_{T1}} \right)}{R_{NTC,T1} \times \left(\frac{1}{V_{T1}} - 1 \right) - R_{NTC,T5} \times \left(\frac{1}{V_{T5}} - 1 \right)} \quad (1)$$

$$RT1 = \frac{\frac{1}{V_{T1}} - 1}{\frac{1}{R_{T2}} + \frac{1}{R_{NTC,T1}}} \quad (2)$$

Select 0°C to 60°C range for Li-ion or Li-polymer battery:

$$R_{NTC,T1} = 27.28k\Omega$$

$$R_{NTC,T5} = 3.02k\Omega$$

$$RT1 = 5.24k\Omega$$

$$RT2 = 30.31k\Omega$$

8.3.4.6 Charging Safety Timer

The device has built-in safety timer to prevent extended charging cycle due to abnormal battery conditions. The user can program fast charge safety timer through I²C (CHG_TIMER bits). When safety timer expires, the fault register TMR_STAT bit is set to 1, and an INT pulse is asserted to the host. The safety timer feature can be disabled by clearing EN_TIMER bit.

During input voltage, current or thermal regulation or cell balancing active mode (cell balancing discharging), the safety timer counts at half clock rate as the actual charge current is likely to be below the register setting. For example, if the charger is in input current regulation (IINDPM_STAT=1) throughout the whole charging cycle, and the safety timer is set to 5 hours, then the timer will expire in 10 hours. This half clock rate feature can be disabled by setting TMR2X_EN = 0. Changing the TMR2X_EN bit while the device is running has no effect on the safety timer count, other than forcing the timer to count at half the rate under the conditions dictated above.

During faults which disable charging, or supplement mode, timer is suspended. Since the timer is not counting in this state, the TMR2X_EN bit has no effect. Once the fault goes away, safety timer resumes. If the charging cycle is stopped and started again, the timer gets reset.

The safety timer is reset for the following events:

1. Charging cycle stop and restart (toggle CD pin, EN_CHG bit, or charged battery falls below recharge threshold).
2. BAT voltage changes from pre-charge to fast-charge or vice versa (in host-mode or default mode).

The precharge safety timer (fixed 2hr counter that runs when VBAT < V_{BAT_LOWV}), follows the same rules as the fast-charge safety timer in terms of getting suspended, reset, and counting at half-rate when TMR2X_EN is set.

8.3.5 Integrated 16-Bit ADC for Monitoring

The device includes a 16-bit ADC to monitor critical system information based on the device's modes of operation. The control of the ADC is done through the [ADC Control Register \(Address = 15h\) \[reset = 30h\]](#). The ADC_EN bit provides the ability to enable and disable the ADC to conserve power. The ADC_RATE bit allows continuous conversion or one-shot behavior. After a one-shot conversion finishes, the ADC_EN bit is cleared, and must be re-asserted to start a new conversion.

To enable the ADC, the ADC_EN bit must be set to '1'. The ADC is allowed to operate if either the V_{VBUS} > V_{VBUS_UVLO_RISING} or V_{BAT} > V_{BAT_UVLO_RISING} is valid. If no adapter is present, and the VBAT is less than V_{BAT_UVLO_RISING}, the device will not perform an ADC measurement, nor update the ADC read-back values in REG17 through REG24. Additionally, the device will immediately reset ADC_EN bit without sending any interrupt. The same will happen if the ADC is enabled when all ADC channels are disabled. It is recommended to read

back ADC_EN after setting it to '1' to ensure ADC is running a conversion. If the charger changes mode (for example, if adapter is connected, EN_HIZ goes to '1', or CD goes high,) while an ADC conversion is running, the conversion is interrupted. Once the mode change is complete, the ADC resumes conversion, starting with the channel where it was interrupted. When device is in HIZ mode, ADC conversion can still be enabled through I2C. In HIZ mode, device power up internally to start ADC conversion and turn back down when ADC conversion is completed.

When TS_ADC conversion performs in battery only mode, the REGN is powered and extra battery current would be drawn. Battery current can be kept low by disabling the TS_ADC conversion in battery only mode.

The integrated ADC has two rate conversion options: a one-shot mode and a continuous conversion mode set by the ADC_RATE bit. By default, all ADC parameters will be converted in one-shot or continuous conversion mode unless disabled in the [ADC Function Disable Register \(Address = 16h\) \[reset = 00h\]](#). If an ADC parameter is disabled by setting the corresponding bit in REG16, then the read-back value in the corresponding register will be from the last valid ADC conversion or the default POR value (all zeros if no conversions have taken place). If an ADC parameter is disabled in the middle of an ADC measurement cycle, the device will finish the conversion of that parameter, but will not convert the parameter starting the next conversion cycle. Even though no conversion takes place when all ADC measurement parameters are disabled, the ADC circuitry is active and ready to begin conversion as soon as one of the bits in the ADC Function Disable register is set to '0'. If all channels are disabled in one-shot conversion mode, the ADC_EN bit is cleared.

The ADC_DONE_STAT and ADC_DONE_FLAG bits signal when a conversion is completed in one-shot mode only. This event produces an $\overline{\text{INT}}$ pulse, which can be masked with ADC_DONE_MASK. During continuous conversion mode, the ADC_DONE_STAT bit has no meaning and will be '0'. The ADC_DONE_FLAG bit will remain unchanged in continuous conversion mode.

ADC conversion operates independently of the faults present in the device. ADC conversion will continue even after a fault has occurred (such as one that causes the power stage to be disabled), and the host must set ADC_EN = '0' to disable the ADC. ADC conversion is interrupted upon adapter plug-in, and will only resume until after Input Source Type Detection is complete. ADC readings are only valid for DC states and not for transients. When host writes ADC_EN=0, the ADC stops immediately, and ADC measurement values correspond to last valid ADC reading.

A recommended method to exit ADC conversion is described below:

1. Write ADC_RATE to one-shot, and the ADC will stop at the end of a complete cycle of conversions, or
2. Disable all ADC conversion channels, and the ADC will stop at the end of the current measurement.

8.3.6 Status Outputs

8.3.6.1 Power Good Indicator ($\overline{\text{PG}}$)

The PG_STAT bit goes HIGH and open drain $\overline{\text{PG}}$ pin goes low to indicate a good input source when:

1. VBUS above $V_{\text{VBUS_UVLO_RISING}}$
2. VBUS below $V_{\text{VBUS_OV}}$ threshold
3. VBUS above V_{POORSRC} (typ. 3.7 V) when I_{POORSRC} (typ. 30 mA) current is applied (not a poor source)
4. Input Source Type Detection is completed
5. CD pin is LOW

8.3.6.2 Charging Status Indicator (STAT)

The device indicates charging state on the open drain STAT pin. The STAT pin can drive LED. The STAT pin function can be disabled via the STAT_DIS bit.

Table 6. STAT Pin State

CHARGING STATE	STAT INDICATOR
Charging in progress (including trickle charge, pre-charge, fast-charge, recharge)	LOW
Charging complete (including top-off)	HIGH
Sleep mode, charge disable	HIGH
Charge suspend (Input over-voltage, TS fault, timer fault)	Blinking at 1Hz

8.3.6.3 Interrupt to Host

In some applications, the host does not always monitor the charger operation. The $\overline{\text{INT}}$ pin notifies the system host on the device operation. By default, the following events will generate an active-low, 256 μs $\overline{\text{INT}}$ pulse.

1. Good input source detected
 - $V_{\text{VBUS}} < V_{\text{VBUS_OV}}$ threshold
 - $V_{\text{VBUS}} > V_{\text{POORSRC}}$ (typ. 3.7 V) when I_{POORSRC} (typ. 30 mA) current is applied (not a poor source)
2. VBUS_STAT changes state (VBUS_STAT any bit change)
3. Good input source removed
4. Entering IINDPM regulation
5. Entering VINDPM regulation
6. Entering IC junction temperature regulation (TREG)
7. I2C Watchdog timer expired
 - At initial power up, this $\overline{\text{INT}}$ gets asserted to signal I2C is ready for communication
8. Charger status changes state (CHRG_STAT value change), including Charge Complete
9. TS_STAT changes state (TS_STAT any bit change)
10. VBUS over-voltage detected (VBUS_OVP)
11. Junction temperature shutdown (TSHUT)
12. Cell over-voltage detected (CELLOVP)
13. Cell over-voltage detected (HS_OV or LS_OV)
14. Charge safety timer expired
15. A rising edge on any of the *_STAT bits

Each one of these $\overline{\text{INT}}$ sources can be masked off to prevent $\overline{\text{INT}}$ pulses from being sent out when they occur. Three bits exist for each one of these events:

- The STAT bit holds the *current status* of each $\overline{\text{INT}}$ source
- The FLAG bit holds information on which source produced an $\overline{\text{INT}}$, regardless of the current status
- The MASK bit is used to prevent the device from sending out $\overline{\text{INT}}$ for each particular event

When one of the above conditions occurs (a rising edge on any of the *_STAT bits), the device sends out an $\overline{\text{INT}}$ pulse and keeps track of which source generated the $\overline{\text{INT}}$ via the FLAG registers. The FLAG register bits are automatically reset to zero after the host reads them, and a new edge on STAT bit is required to re-assert the FLAG.

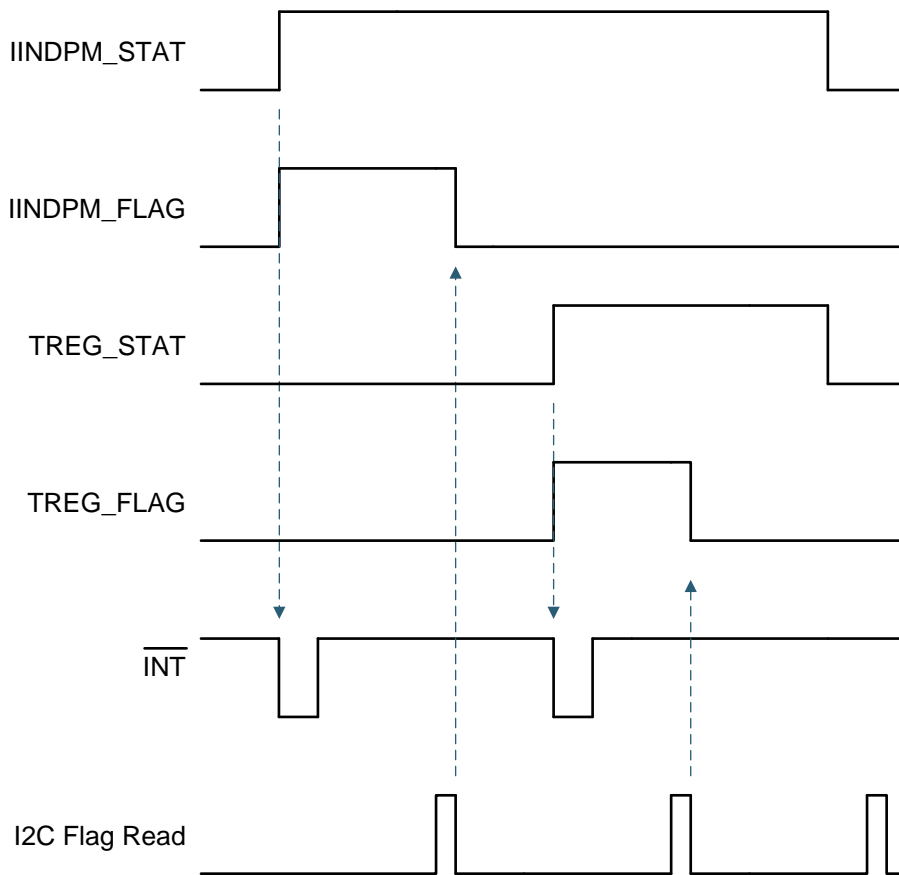

Figure 17. $\overline{\text{INT}}$ Generation Behavior Example

8.3.7 Input Current Limit on ILIM Pin

For safe operation, the BQ2588x has an additional hardware pin on ILIM to limit maximum input current. The maximum input current is set by a resistor from ILIM pin to ground as:

$$I_{\text{INMAX}} = \frac{K_{\text{ILIM}}}{R_{\text{ILIM}}} \quad (3)$$

The actual input current limit is the lower value between ILIM pin setting and register setting (IINDPM). For example, if the register setting is 3.3A (0x1C), and ILIM has a 820-Ω resistor ($K_{\text{ILIM}} = 1276$ max) to ground for 1.55A, the input current limit is 1.55A. ILIM pin can be used to set the input current limit rather than the register settings when EN_ILIM bit is set. The device regulates ILIM pin at 0.8V. If ILIM voltage exceeds 0.8V, the device enters input current regulation (Refer to section). Entering IINDPM through ILIM pin sets the IINDPM_STAT and FLAG bits, and produces an interrupt to host. The interrupt can be masked via the IINDPM_MASK bit.

The ILIM pin can also be used to monitor input current when EN_ILIM is set. The voltage on ILIM pin is proportional to the input current. ILIM can be used to monitor input current with the following relationship:

$$I_{\text{IN}} = \frac{K_{\text{ILIM}} \times V_{\text{ILIM}}}{R_{\text{ILIM}} \times 0.8\text{V}} \quad (4)$$

For example, if ILIM pin is set with 820-Ω resistor, and the ILIM voltage 0.5V, the actual input current is 0.795A to 0.973A. If ILIM pin is open, the input current is limited to zero since ILIM voltage floats above 0.8V. If ILIM pin is shorted, the input current limit is set by the register.

The ILIM pin function can be disabled by setting the EN_ILIM bit to 0. When the pin is disabled, both input current limit function and monitoring function are not available.

8.3.8 Voltage and Current Monitoring

The device closely monitors the input voltage, as well as internal FET currents for safe boost and buck mode operation.

8.3.8.1 Voltage and Current Monitoring in Boost Mode

8.3.8.1.1 Input Over-voltage Protection

The valid input voltage range for boost mode operation is V_{VBUS_OP} . If VBUS voltage exceeds V_{VBUS_OV} , the device stops switching immediately to protect the power FETs. During input over-voltage, an \overline{INT} pulse is asserted to signal the host, and the `VBUS_OVP_STAT` and `VBUS_OVP_FLAG` fault registers get set. The device automatically starts switching again when the over-voltage condition goes away.

8.3.8.1.2 Input Under-voltage Protection

The valid input voltage range for boost mode operation is V_{VBUS_OP} . If VBUS voltage falls below $V_{POORSRC}$ during operation, the device stops switching. During input under-voltage, an \overline{INT} pulse is asserted to signal the host, and the `PG_STAT` bit gets cleared. The `PG_FLAG` bit will get set to signal this event. The device automatically attempts to restart switching when the under-voltage condition goes away.

8.3.8.1.3 System Over-voltage Protection

The charger device clamps the system voltage during load transient so that the components connect to system would not be damaged due to high voltage. `SYSOVP` threshold is 350 mV above system regulation voltage. Upon `SYSOVP`, converter stops immediately to clamp the overshoot.

8.3.8.1.4 System Over-current Protection

The charger device continually monitors and compares VBUS to VSYS to protect against a system short-circuit event. In the event that VSYS drops to within 250 mV of VBUS during operation, a short circuit event is flagged and the converter stops switching. The `SYS_SHORT_FLAG` or `SNS_SHORT_FLAG` bit is set and an \overline{INT} pulse is asserted to the host. The device attempts to recover from this condition automatically.

8.3.9 Thermal Regulation and Thermal Shutdown

8.3.9.1 Thermal Protection in Boost Mode

The device monitors internal junction temperature, T_J , to avoid overheating and limits the IC surface temperature in boost mode. When the internal junction temperature exceeds the preset thermal regulation limit (`TREG` bits), the device reduces charge current. A wide thermal regulation range from 60°C to 120°C allows optimization for the system thermal performance.

During thermal regulation, the actual charging current is usually below the programmed value in `ICHG` registers. Therefore, `termination` is disabled, the safety timer runs at half the clock rate, the status register `TREG_STAT` bit goes high, and an \overline{INT} is asserted to the host.

Additionally, the device has thermal shutdown to turn off the converter when IC surface temperature exceeds T_{SHUT} . The fault register bits `TSHUT_STAT` and `TSHUT_FLAG` are set and an \overline{INT} pulse is asserted to the host. The converter turns back on when IC temperature is below T_{SHUT_HYS} .

8.3.10 Battery Protection

8.3.11 Serial Interface

The device uses I2C compatible interface for flexible charging parameter programming and instantaneous device status reporting. I2C is a bi-directional 2-wire serial interface. Only two open-drain bus lines are required: a serial data line (SDA), and a serial clock line (SCL). Devices can be considered as masters or slaves when performing data transfers. A master is a device which initiates a data transfer on the bus and generates the clock signals to permit that transfer. At that time, any device addressed is considered a slave.

The device operates as a slave device with address 0x6A, receiving control inputs from the master device like micro-controller or digital signal processor through REG00 – REG2C. Register read beyond REG2C (0x2C), returns 0xFF. The I2C interface supports both standard mode (up to 100kbits/s), and fast mode (up to 400kbits/s). When the bus is free, both lines are HIGH. The SDA and SCL pins are open drain and must be connected to the positive supply voltage via a current source or pull-up resistor.

8.3.11.1 Data Validity

The data on the SDA line must be stable during the HIGH period of the clock. The HIGH or LOW state of the data line can only change when the clock signal on SCL line is LOW. One clock pulse is generated for each data bit transferred.

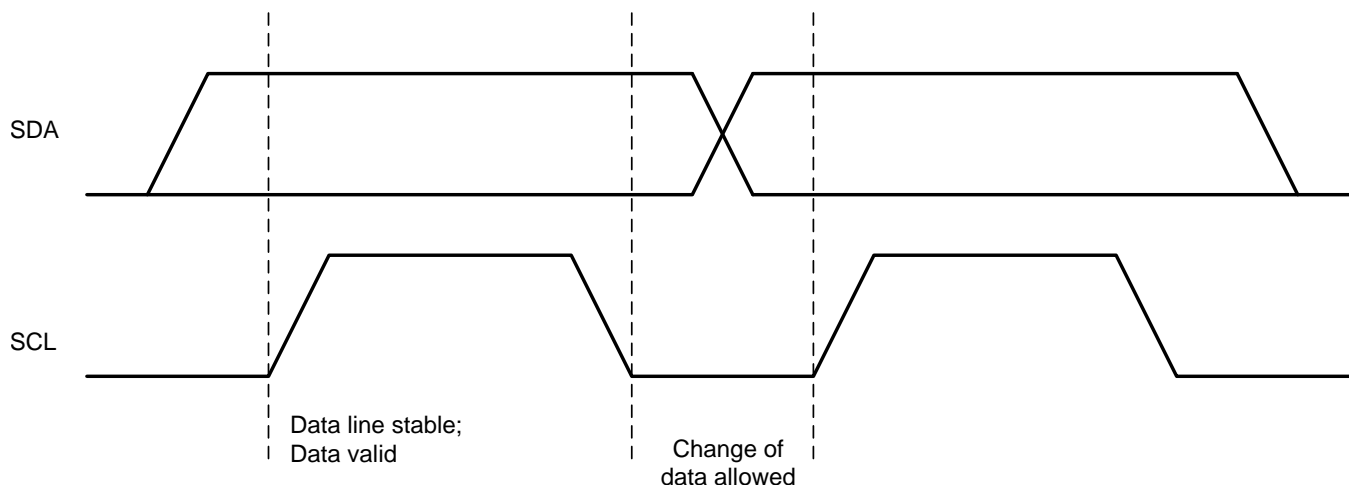

Figure 18. Bit Transfers on the I2C bus

8.3.11.2 START and STOP Conditions

All transactions begin with a START (S) and are terminated with a STOP (P). A HIGH to LOW transition on the SDA line while SCL is HIGH defines a START condition. A LOW to HIGH transition on the SDA line when the SCL is HIGH defines a STOP condition.

START and STOP conditions are always generated by the master. The bus is considered busy after the START condition, and free after the STOP condition.

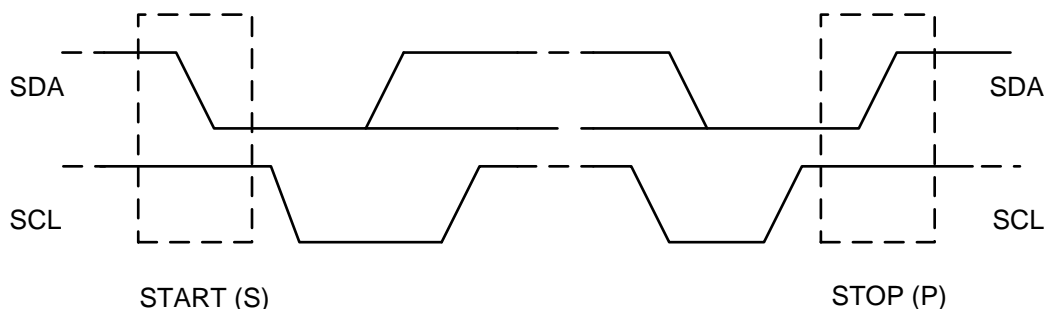

Figure 19. START and STOP conditions on the I2C bus

8.3.11.3 Byte Format

Every byte on the SDA line must be 8 bits long. The number of bytes to be transmitted per transfer is unrestricted. Each byte has to be followed by an ACKNOWLEDGE (ACK) bit. Data is transferred with the Most Significant Bit (MSB) first. If a slave cannot receive or transmit another complete byte of data until it has performed some other function, it can hold the SCL line low to force the master into a wait state (clock stretching). Data transfer then continues when the slave is ready for another byte of data and releases the SCL line.

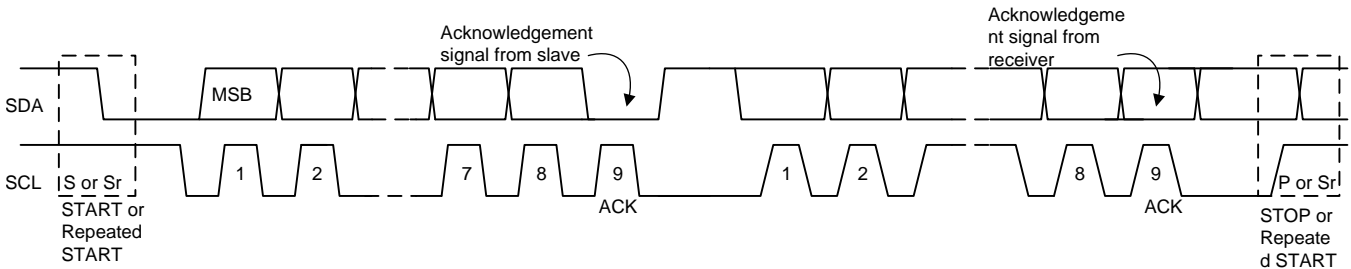

Figure 20. Data Transfer on the I2C Bus

8.3.11.4 Acknowledge (ACK) and Not Acknowledge (NACK)

The ACK signaling takes place after byte. The ACK bit allows the receiver to signal the transmitter that the byte was successfully received and another byte may be sent. All clock pulses, including the acknowledge 9th clock pulse, are generated by the master.

The transmitter releases the SDA line during the acknowledge clock pulse so the receiver can pull the SDA line LOW and it remains stable LOW during the HIGH period of this 9th clock pulse.

A NACK is signaled when the SDA line remains HIGH during the 9th clock pulse. The master can then generate either a STOP to abort the transfer or a repeated START to start a new transfer.

8.3.11.5 Slave Address and Data Direction Bit

After the START signal, a slave address is sent. This address is 7 bits long, followed by the 8 bit as a data direction bit (bit R/W). A zero indicates a transmission (WRITE) and a one indicates a request for data (READ). The device 7-bit address is defined as 1101 011' (0x6B) by default. The address bit arrangement is shown below.

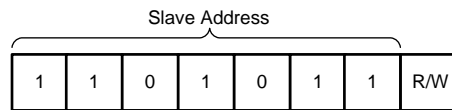

Figure 21. 7-Bit Addressing (0x6B)

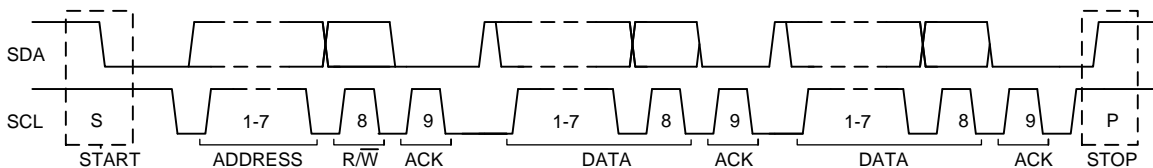

Figure 22. Complete Data Transfer on the I2C Bus

8.3.11.6 Single Write and Read

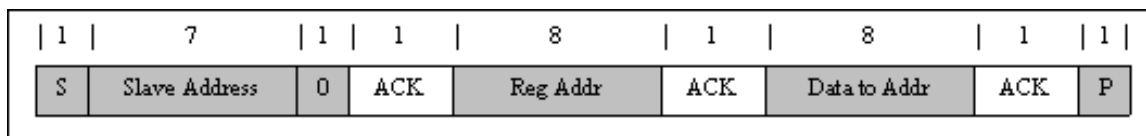

Figure 23. Single Write

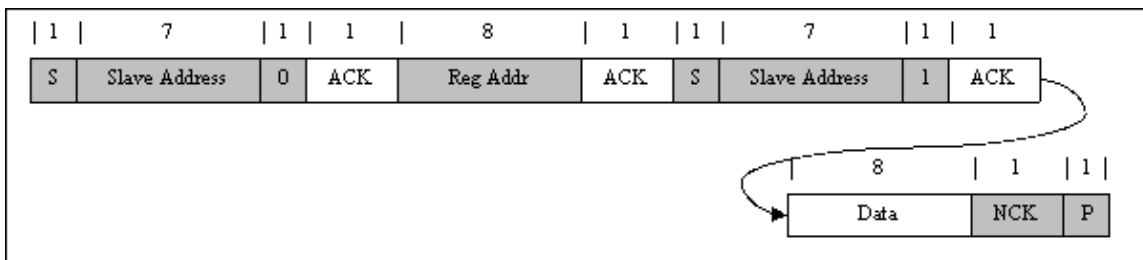

Figure 24. Single Read

If the register address is not defined, the charger IC sends back NACK and returns to the idle state.

8.3.11.7 Multi-Write and Multi-Read

The charger device supports multi-read and multi-write of all registers.

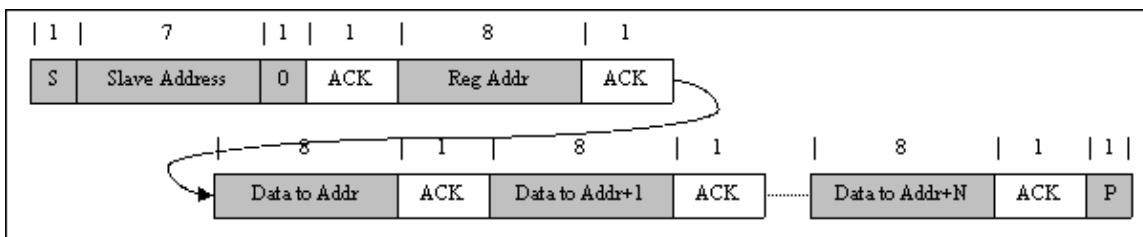

Figure 25. Multi-Write

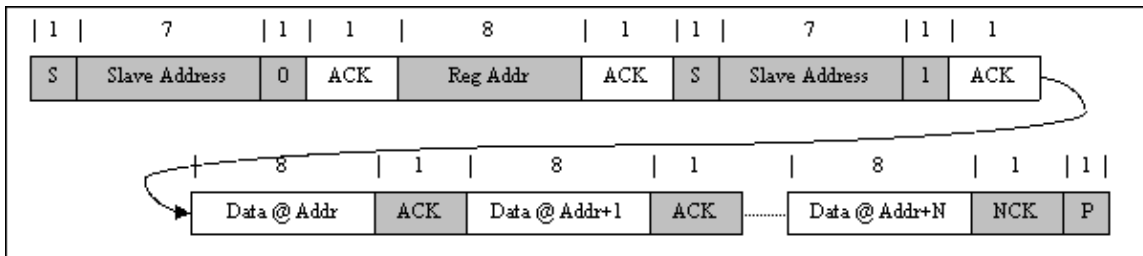

Figure 26. Multi-Read

8.4 Device Functional Modes

8.4.1 Host Mode and Default Mode

The BQ2588x is a host controlled charger, but it can operate in default mode without host management. In default mode, the device can be used as an autonomous charger with no host or while host is in sleep mode. When the charger is in default mode, WD_STAT bit is HIGH. When the charger is in host mode, WD_STAT bit is LOW.

After power-on-reset, the device starts in default mode with watchdog timer expired, or default mode. All the registers are in the default settings. During default mode, any change on PSEL pin will make real time internal reference change.

In default mode, the device keeps charging the battery with default 12-hour fast charging safety timer. At the end of the 12-hour, the charging is stopped and the buck converter continues to operate to supply system load.

A I2C write to the registers transitions the charger from default mode to host mode and watchdog timer is reset. All the device parameters can be programmed by the host. To keep the device in host mode, the host has to reset the watchdog timer by writing 1 to WD_RST bit before the watchdog timer expires (WD_STAT bit is set), or disable watchdog timer by setting WATCHDOG bits=00.

Device Functional Modes (continued)

When the watchdog timer (WD_STAT bit = 1) is expired, the device returns to default mode and all registers are reset to default values except as detailed in the [Register Maps](#) section. The Watchdog timer will be reset on any write if the watchdog timer has expired.

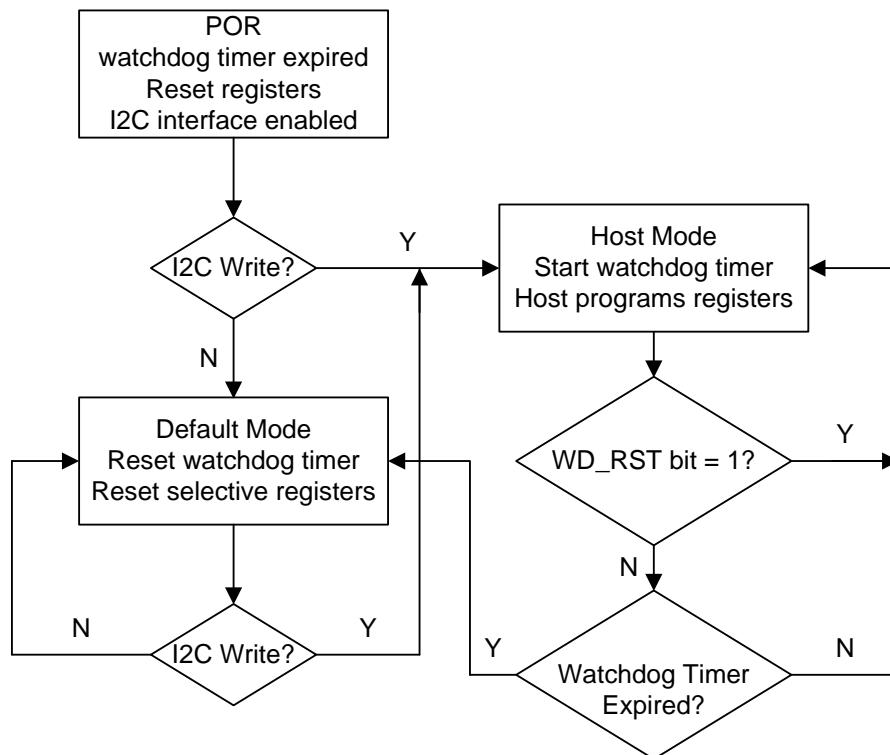

Figure 27. Watchdog Timer Flow Chart

8.5 Register Maps

Default I2C Slave Address: 0x6B (1101 011B + R/W)

Table 7. I²C Registers

Address	Access Type	Acronym	Register Name	Section
00h	R/W	REG00	Cell Voltage Limit	Go
01h	R/W	REG01	Charge Current Limit	Go
02h	R/W	REG02	Input Voltage Limit	Go
03h	R/W	REG03	Input Current Limit	Go
04h	R/W	REG04	Precharge and Termination Control	Go
05h	R/W	REG05	Charger Control 1	Go
06h	R/W	REG06	Charger Control 2	Go
07h	R/W	REG07	Charger Control 3	Go
08h	R/W	REG08	Charger Control 4	Go
09h	R/W	REG09	Reserved	Go
0Ah	R	REG0A	ICO Current Limit	Go
0Bh	R	REG0B	Charger Status 1	Go
0Ch	R	REG0C	Charger Status 2	Go
0Dh	R	REG0D	NTC Status	Go
0Eh	R	REG0E	FAULT Status	Go

ADVANCE INFORMATION

Table 7. I²C Registers (continued)

Address	Access Type	Acronym	Register Name	Section
0Fh	R	REG0F	Charger Flag 1	Go
10h	R	REG10	Charger Flag 2	Go
11h	R	REG11	Fault Flag	Go
12h	R/W	REG12	Charger Mask 1	Go
13h	R/W	REG13	Charger Mask 2	Go
14h	R/W	REG14	Fault Mask	Go
15h	R/W	REG15	ADC Control	Go
16h	R/W	REG16	ADC Function Disable	Go
17h	R	REG17	IBUS ADC1	Go
18h	R	REG18	IBUS ADC0	Go
19h	R	REG19	ICHG ADC1	Go
1Ah	R	REG1A	ICHG ADC0	Go
1Bh	R	REG1B	VBUS ADC1	Go
1Ch	R	REG1C	VBUS ADC0	Go
1Dh	R	REG1D	VBAT ADC1	Go
1Eh	R	REG1E	VBAT ADC0	Go
1Fh	R	REG1F	VCELLTOP ADC1	Go
20h	R	REG20	VCELLTOP ADC0	Go
21h	R	REG21	TS ADC1	Go
22h	R	REG22	TS ADC0	Go
23h	R	REG23	TDIE ADC1	Go
24h	R	REG24	TDIE ADC0	Go
25h	R/W	REG25	Part Information	Go
26h	R	REG26	VCELLBOT ADC1	Go
27h	R	REG27	VCELLBOT ADC0	Go
28h	R/W	REG28	Cell Balancing Control 1	Go
29h	R/W	REG29	Cell Balancing Control 2	Go
2Ah	R/W	REG2A	Cell Balancing Status and Control	Go
2Bh	R	REG2B	Cell Balancing Flag	Go
2Ch	R/W	REG2C	Cell Balancing Mask	Go

Complex bit access types are encoded to fit into small table cells. [Table 8](#) shows the codes that are used for access types in this section.

Table 8. I²C Access Type Codes

Access Type	Code	Description
Read Type		
R	R	Read
Write Type		
W	W	Write
Reset Value		
-n		Value after reset
-X		Undefined value

8.5.1 Cell Voltage Regulation Limit Register (Address = 00h) [reset = A0h]

 REG00 is shown in [Figure 28](#) and described in .

 Return to [Summary Table](#).

Figure 28. REG00 Register

Bit	7	6	5	4	3	2	1	0
Field	VCELLREG[7:0]							

Table 9. REG00 Register Field Descriptions

Bit	Field	Type	Reset by REG_RST	Reset by WATCHDOG	Description
7	VCELLREG[7]	R/W	Yes	Yes	640 mV
6	VCELLREG[6]	R/W	Yes	Yes	320 mV
5	VCELLREG[5]	R/W	Yes	Yes	160 mV
4	VCELLREG[4]	R/W	Yes	Yes	80 mV
3	VCELLREG[3]	R/W	Yes	Yes	40 mV
2	VCELLREG[2]	R/W	Yes	Yes	20 mV
1	VCELLREG[1]	R/W	Yes	Yes	10 mV
0	VCELLREG[0]	R/W	Yes	Yes	5 mV

 Cell Charge voltage limit
 Offset: 3.40 V
 Range: 3.40 V to 4.60 V
 Default 4.20 V

8.5.2 Charger Current Limit Register (Address = 01h) [reset = 5Eh]

REG01 is shown in [Figure 29](#) and described in [Table 10](#).

Return to [Summary Table](#).

Figure 29. REG01 Register

Bit	7	6	5	4	3	2	1	0
Field	EN_HIZ	EN_ILIM	ICHG[5:0]					

Table 10. REG01 Register Field Descriptions

Bit	Field	Type	Reset by REG_RST	Reset by WATCHDOG	Description
7	EN_HIZ	R/W	Yes	Yes	Enable HIZ Mode: 0 – Disable (default) 1 – Enable
6	EN_ILIM	R/W	Yes	Yes	Enable ILIM Pin Function: 0 – Disable 1 – Enable (default)
5	ICHG[5]	R/W	Yes	Yes	1600 mA
4	ICHG[4]	R/W	Yes	Yes	800 mA
3	ICHG[3]	R/W	Yes	Yes	400 mA
2	ICHG[2]	R/W	Yes	Yes	200 mA
1	ICHG[1]	R/W	Yes	Yes	100 mA
0	ICHG[0]	R/W	Yes	Yes	50 mA

Fast Charge Current Limit
Offset: 100 mA
Range: 100mA – 2200mA
Default 1500 mA
Note: ICHG > 2.2A (2Ch) clamped to 2.2A. ICHG < 100mA (01h) clamped at 100mA

8.5.3 Input Voltage Limit Register (Address = 02h) [reset = 84h]

REG02 is shown in [Figure 30](#) and described in [Table 11](#).

Return to [Summary Table](#).

Figure 30. REG02 Register

Bit	7	6	5	4	3	2	1	0
Reset	1h	0h	0h	04h				
Field	EN_VINDPM_RST	EN_BAT_DISCHG	PFM_OOA_DIS	VINDPM[4:0]				

Table 11. REG02 Register Field Descriptions

Bit	Field	Type	Reset by REG_RST	Reset by WATCHDOG	Description	
7	EN_VINDPM_RST	R/W	Yes	Yes	Enable VINDPM automatic reset upon adapter plugin: 0 – Disable VINDPM reset when adapter is plugged in 1 – Enable VINDPM reset when adapter is plugged in (VINDPM resets to default value after Input Source Type Detection) (Default)	
6	EN_BAT_DISCHG	R/W	Yes	Yes	Enable BAT pin discharge load (IBAT_DISCHG): 0 – Disable load (Default) 1 – Enable BAT discharge load	
5	PFM_OOA_DIS	R/W	Yes	No	PFM Out-of-Audio (OOA) Mode Disable: 0 – Out-of-audio mode enabled while converter is in PFM (Default) 1 – Out-of-audio mode disabled while converter is in PFM	
4	VINDPM[4]	R/W	Yes	No	1600 mV	Absolute Input Voltage Limit: Offset: 3.9 V Range: 3.9V – 5.5V Default: 4.5 V Note: VINDPM > 5.5V (10h) clamped to 5.5V. VINDPM register is reset upon adapter plug-in if EN_VINDPM_RST = 1.
3	VINDPM[3]	R/W	Yes	No	800 mV	
2	VINDPM[2]	R/W	Yes	No	400 mV	
1	VINDPM[1]	R/W	Yes	No	200 mV	
0	VINDPM[0]	R/W	Yes	No	100 mV	

8.5.4 Input Current Limit Register (Address = 03h) [reset = 39h]

REG03 is shown in [Figure 31](#) and described in [Table 12](#).

Return to [Summary Table](#).

Figure 31. REG03 Register

Bit	7	6	5	4	3	2	1	0
Field	FORCE_ICO	FORCE_INDET	EN_ICO	IINDPM[4:0]				

Table 12. REG03 Register Field Descriptions

Bit	Field	Type	Reset by REG_RST	Reset by WATCHDOG	Description	
7	FORCE_ICO	R/W	Yes	Yes	Force Start Input Current Optimizer (ICO): 0 – Do not force ICO (default) 1 – Force ICO start Note: This bit can only be set and always returns 0 after ICO starts. This bit only valid when EN_ICO = 1.	
6	FORCE_INDET	R/W	Yes	Yes	Force D+/D– or PSEL Detection: 0 – Not in D+/D– or PSEL detection (default) 1 – Force D+/D– or PSEL detection	
5	EN_ICO	R/W	Yes	No	Input Current Optimization (ICO) Algorithm Control: 0 – Disable ICO 1 – Enable ICO (default)	
4	IINDPM[4]	R/W	Yes	No	1600 mA	Input Current Limit: Offset: 500 mA Range: 500mA – 3300mA Default: 3000mA Note: IINDPM > 3300 mA (1Ch) clamped to 3300mA. Actual input current limit is lower of I2C, ICOILIM, ILIM pin or PSEL.
3	IINDPM[3]	R/W	Yes	No	800 mA	
2	IINDPM[2]	R/W	Yes	No	400 mA	
1	IINDPM[1]	R/W	Yes	No	200 mA	
0	IINDPM[0]	R/W	Yes	No	100 mA	

8.5.5 Precharge and Termination Current Limit Register (Address = 04h) [reset = 22h]

REG04 is shown in [Figure 32](#) and described in [Table 13](#).

Return to [Summary Table](#).

Figure 32. REG04 Register

Bit	7	6	5	4	3	2	1	0
Field	IPRECHG[3:0]				ITERM[3:0]			

Table 13. REG04 Register Field Descriptions

Bit	Field	Type	Reset by REG_RST	Reset by WATCHDOG	Description	
7	IPRECHG[3]	R/W	Yes	Yes	400 mA	Precharge Current Limit: Offset: 50 mA Range: 50mA – 800mA Default: 150mA
6	IPRECHG[2]	R/W	Yes	Yes	200 mA	
5	IPRECHG[1]	R/W	Yes	Yes	100 mA	
4	IPRECHG[0]	R/W	Yes	Yes	50 mA	
3	ITERM[3]	R/W	Yes	Yes	400 mA	Termination Current Limit: Offset: 50 mA Range: 50mA – 800mA Default: 150mA
2	ITERM[2]	R/W	Yes	Yes	200 mA	
1	ITERM[1]	R/W	Yes	Yes	100 mA	
0	ITERM[0]	R/W	Yes	Yes	50 mA	

8.5.6 Charger Control 1 Register (Address = 05h) [reset = 9Dh]

REG05 is shown in [Figure 33](#) and described in [Table 14](#).

Return to [Summary Table](#).

Figure 33. REG05 Register

Bit	7	6	5	4	3	2	1	0
Field	EN_TERM	STAT_DIS	WATCHDOG[1:0]		EN_TIMER	CHG_TIMER[1:0]		TMR2X_EN

Table 14. REG05 Register Field Descriptions

Bit	Field	Type	Reset by REG_RST	Reset by WATCHDOG	Description
7	EN_TERM	R/W	Yes	Yes	Termination Control: 0 – Disable termination 1 – Enable termination (default)
6	STAT_DIS	R/W	Yes	Yes	STAT Pin Disable: 0 – Enable STAT pin function (default) 1 – Disable STAT pin function
5	WATCHDOG[1]	R/W	Yes	Yes	I2C Watchdog Timer Settings: 00 – Disable WD Timer 01 – 40s (default) 10 – 80s 11 – 160s
4	WATCHDOG[0]	R/W	Yes	Yes	
3	EN_TIMER	R/W	Yes	Yes	Charging Safety Timer Enable 0 – Disable 1 – Enable (Default)
2	CHG_TIMER[1]	R/W	Yes	Yes	Fast Charge Timer Setting 00 – 5 hrs 01 – 8 hrs 10 – 12 hrs (Default) 11 – 20 hrs
1	CHG_TIMER[0]	R/W	Yes	Yes	
0	TMR2X_EN	R/W	Yes	Yes	Safety Timer during DPM or TREG 0 – Safety timer always count normally 1 – Safety timer slowed by 2X during input DPM or TREG (Default)

8.5.7 Charger Control 2 Register (Address = 06h) [reset = 7Dh]

REG06 is shown in [Figure 34](#) and described in [Table 15](#).

Return to [Summary Table](#).

Figure 34. REG06 Register

Bit	7	6	5	4	3	2	1	0
Field	Reserved	AUTO_INDET_EN	TREG[1:0]		EN_CHG	CELLLOWV	VRECHG[1:0]	

Table 15. REG06 Register Field Descriptions

Bit	Field	Type	Reset by REG_RST	Reset by WATCHDOG	Description	
7	Reserved	R/W	Yes	Yes	Reserved bit always reads 0.	
6	AUTO_INDET_EN	R/W	Yes	Yes	Automatic D+/D- Detection Enable: 0 – Disable D+/D- or PSEL detection when VBUS plugs in 1 – Enable D+/D- or PSEL detection when VBUS plugs in (default)	
5	TREG[1]	R/W	Yes	Yes	Thermal Regulation Threshold 00 – 60°C 01 – 80°C 10 – 100°C 11 – 120°C (Default)	
4	TREG[0]	R/W	Yes	Yes		
3	EN_CHG	R/W	Yes	Yes	Charger Enable Configuration 0 – Charge Disable 1 – Charge Enable (default) Note: If EN_OTG and EN_CHG are set simultaneously, EN_CHG takes priority	
2	CELLLOWV	R/W	Yes	Yes	Battery precharge to fast-charge threshold: 0 – 2.8V 1 – 3.0V (default)	
1	VCELL_RECHG[1]	R/W	Yes	No	100 mV	Cell Recharge Threshold Offset (below VCELLREG) Offset: 50mV Range: 50mV – 200mV Default: 100mV
0	VCELL_RECHG[0]	R/W	Yes	No	50 mV	

8.5.8 Charger Control 3 Register (Address = 07h) [reset = 00h]

REG07 is shown in [Figure 35](#) and described in [Table 16](#).

Return to [Summary Table](#).

Figure 35. REG07 Register

Bit	7	6	5	4	3	2	1	0
Reset	0h	0h	0h		0h			
Field	PFM_DIS	WD_RST	TOPOFF_TIMER[1:0]		Reserved			

Table 16. REG07 Register Field Descriptions

Bit	Field	Type	Reset by REG_RST	Reset by WATCHDOG	Description
7	PFM_DIS	R/W	Yes	No	PFM Mode Disable control: 0 – Enable PFM operation (default) 1 – Disable PFM operation
6	WD_RST	R/W	Yes	Yes	I2C Watchdog Timer Reset: 0 – Normal 1 – Reset (Bit goes back to 0 after timer reset)
5	TOPOFF_TIMER[1]	R/W	Yes	Yes	Top-off Timer Control : 00 – Disabled (default) 01 – 15 mins 10 – 30 mins 11 – 45 mins
4	TOPOFF_TIMER[0]	R/W	Yes	Yes	
3	RESERVED	R	No	No	Reserved bit always reads 0
2	RESERVED	R	No	No	Reserved bit always reads 0
1	RESERVED	R	No	No	This bit reads back 1.
0	RESERVED	R	No	No	Reserved bit always reads 0

8.5.9 Charger Control 4 Register (Address = 08h) [reset = 0Dh]

REG08 is shown in [Figure 36](#) and described in [Table 17](#).

Return to [Summary Table](#).

Figure 36. REG08 Register

Bit	7	6	5	4	3	2	1	0
Reset	0h			1h		1h	1h	
Field	Reserved[2:0]			JEITA_VSET[1:0]		JEITA_ISETH	JEITA_ISETC[1:0]	

Table 17. REG08 Register Field Descriptions

Bit	Field	Type	Reset by REG_RST	Reset by WATCHDOG	Description
7	RESERVED	R	No	No	Reserved bit always reads 0
6	RESERVED	R	No	No	Reserved bit always reads 0
5	RESERVED	R	No	No	Reserved bit always reads 0
4	JEITA_VSET[1]	R/W	Yes	Yes	JEITA High Temp. (45C – 60C) Voltage Setting: 00 – Charge Suspend 01 – Set VREG to 8.0V (default) 10 – Set VREG to 8.3V 11 – VREG unchanged
3	JEITA_VSET[0]	R/W	Yes	Yes	
2	JEITA_ISETH	R/W	Yes	Yes	JEITA High Temp. (45C – 60C) Current Setting (percentage with respect to ICHG REG01[5:0]): 0 – 40% of ICHG 1 – 100% of ICHG (default)
1	JEITA_ISETC[1]	R/W	Yes	Yes	JEITA Low Temp. (0C – 10C) Current Setting (percentage with respect to ICHG REG01[5:0]): 00 – Charge Suspend 01 – 20% of ICHG (default) 10 – 40% of ICHG 11 – 100% of ICHG
0	JEITA_ISETC[0]	R/W	Yes	Yes	

8.5.10 Reserved Register (Address = 09h) [reset = 00h]

REG09 is shown in [Figure 37](#) and described in [Table 18](#).

Return to [Summary Table](#).

Figure 37. REG09 Register

Bit	7	6	5	4	3	2	1	0
Reset	0h							
Field	Reserved[7:0]							

Table 18. REG09 Register Field Descriptions

Bit	Field	Type	Reset by REG_RST	Reset by WATCHDOG	Description
7:0	RESERVED	R	No	No	Reserved bit always reads 0h

8.5.11 ICO Current Limit in Use Register (Address = 0Ah) [reset = XXh]

 REG0A is shown in [Figure 38](#) and described in [Table 19](#).

 Return to [Summary Table](#).

Figure 38. REG0A Register

Bit	7	6	5	4	3	2	1	0
Reset	0	0	0	X	X	X	X	X
Field	RESERVED	RESERVED	RESERVED	ICO_ILIM[4:0]				

Table 19. REG0A Register Field Descriptions

Bit	Field	Type	Reset by REG_RST	Reset by WATCHDOG	Description
7	RESERVED	R	No	No	Reserved bit always reads 0
6	RESERVED	R	No	No	Reserved bit always reads 0
5	RESERVED	R	No	No	Reserved bit always reads 0
4	ICO_ILIM[4]	R	No	No	1600 mA
3	ICO_ILIM[3]	R	No	No	800 mA
2	ICO_ILIM[2]	R	No	No	400 mA
1	ICO_ILIM[1]	R	No	No	200 mA
0	ICO_ILIM[0]	R	No	No	100 mA

Input Current Limit in use when ICO is enabled:
Offset: 500 mA
Range: 500mA – 3300mA

8.5.12 Charger Status 1 Register (Address = 0Bh) [reset = XXh]

REG0B is shown in [Figure 39](#) and described in [Table 20](#).

Return to [Summary Table](#).

Figure 39. REG0B Register

Bit	7	6	5	4	3	2	1	0
Reset	X	X	X	X	X	X	X	X
Field	Reserved	IINDPM_STAT	VINDPM_STAT	TREG_STAT	WD_STAT	CHRG_STAT[2:0]		

Table 20. REG0B Register Field Descriptions

Bit	Field	Type	Reset by REG_RST	Reset by WATCHDOG	Description
7	Reserved	R	No	No	Reserved bit always reads 0
6	IINDPM_STAT	R	No	No	IINDPM Status: 0 – Normal 1 – In IINDPM Regulation (ILIM pin or IINDPM register)
5	VINDPM_STAT	R	No	No	VINDPM Status: 0 – Normal 1 – In VINDPM Regulation
4	TREG_STAT	R	No	No	IC Thermal regulation Status: 0 – Normal 1 – In Thermal Regulation
3	WD_STAT	R	No	No	I2C Watchdog Timer Status bit: 0 – Normal 1 – WD Timer expired
2	CHRG_STAT[2]	R	No	No	Charge Status bits: 000 – Not Charging 001 – Trickle Charge (VBAT < VBAT_SHORT) 010 – Pre-charge (VBAT_UVLO_RISING < VBAT < VBAT_LOWV) 011 – Fast-charge (CC mode) 100 – Taper Charge (CV mode) 101 – Top-off Timer Charging 110 – Charge Termination Done 111 – Reserved
1	CHRG_STAT[1]	R	No	No	
0	CHRG_STAT[0]	R	No	No	

8.5.13 Charger Status 2 Register (Address = 0Ch) [reset = XXh]

REG0C is shown in [Figure 40](#) and described in [Table 21](#).

Return to [Summary Table](#).

Figure 40. REG0C Register

Bit	7	6	5	4	3	2	1	0
Reset	X	X	X	X	0	X	X	X
Field	PG_STAT	VBUS_STAT[2:0]			RESERVED	ICO_STAT[1]	ICO_STAT[0]	Reserved

Table 21. REG0C Register Field Descriptions

Bit	Field	Type	Reset by REG_RST	Reset by WATCHDOG	Description
7	PG_STAT	R	No	No	Power Good Status: 0 – Not Power Good 1 – Power Good
6	VBUS_STAT[2]	R	No	No	VBUS Detection Status 000 – No Input 001 – USB Host SDP ---> PSEL High 010 - USB CDP (1.5 A) 011 – Adapter (3.0A) ---> PSEL low 100 – POORSRC detected 7 consecutive times 101 - Unknown Adapter (500 mA) 110 - Non-standard Adapter (1 A/2 A/2.1 A/2.4 A)
5	VBUS_STAT[1]	R	No	No	
4	VBUS_STAT[0]	R	No	No	
3	RESERVED	R	No	No	Reserved bit always reads 0h
2	ICO_STAT[1]	R	No	No	Input Current Optimizer (ICO) Status: 00 – ICO Disabled 01 – ICO Optimization is in progress 10 – Maximum input current detected 11 – Reserved
1	ICO_STAT[0]	R	No	No	
0	Reserved	R	No	No	Reserved bit always reads 0h

8.5.14 NTC Status Register (Address = 0Dh) [reset = 0Xh]

 REG0D is shown in [Figure 41](#) and described in [Table 22](#).

 Return to [Summary Table](#).

Figure 41. REG0D Register

Bit	7	6	5	4	3	2	1	0
Reset	0	0	0	0	0	X	X	X
Field	RESERVED		RESERVED	RESERVED	RESERVED	TS_STAT[2:0]		

Table 22. REG0D Register Field Descriptions

Bit	Field	Type	Reset by REG_RST	Reset by WATCHDOG	Description
7	RESERVED	R	Yes	No	Reserved bit always reads 0h
6	RESERVED	R	Yes	No	Reserved bit always reads 0h
5	RESERVED	R	Yes	No	Reserved bit always reads 0h
4	RESERVED	R	Yes	No	Reserved bit always reads 0h
3	RESERVED	R	Yes	No	Reserved bit always reads 0h
2	TS_STAT[2]	R	No	No	NTC (TS) Status: 000 – Normal 010 – TS Warm 011 – TS Cool 101 – TS Cold 110 – TS Hot
1	TS_STAT[1]	R	No	No	
0	TS_STAT[0]	R	No	No	

8.5.15 FAULT Status Register (Address = 0Eh) [reset = XXh]

 REG0E is shown in [Figure 42](#) and described in [Table 23](#).

 Return to [Summary Table](#).

Figure 42. REG0E Register

Bit	7	6	5	4	3	2	1	0
Reset	X	X	0	X	0	0	0	X
Field	VBUS_OVP_STAT	TSHUT_STAT	Reserved	TMR_STAT	RESERVED	RESERVED	RESERVED	Reserved

Table 23. REG0E Register Field Descriptions

Bit	Field	Type	Reset by REG_RST	Reset by WATCHDOG	Description
7	VBUS_OVP_STAT	R	No	No	Input over-voltage Status: 0 – Normal 1 – Device in over-voltage protection
6	TSHUT_STAT	R	No	No	IC Temperature shutdown Status: 0 – Normal 1 – Device in thermal shutdown protection
5	RESERVED	R	No	No	Reserved bit always reads 0h
4	TMR_STAT	R	No	No	Charge Safety timer Status: 0 – Normal 1 – Charge Safety timer expired
3	RESERVED	R	No	No	Reserved bit always reads 0h
2	RESERVED	R	No	No	Reserved bit always reads 0h
1	RESERVED	R	No	No	Reserved bit always reads 0h
0	RESERVED	R	No	No	Reserved bit always reads 0h

8.5.16 Charger Flag 1 Register (Address = 0Fh) [reset = 00h]

REG0F is shown in [Figure 43](#) and described in [Table 24](#).

Return to [Summary Table](#).

Figure 43. REG0F Register

Bit	7	6	5	4	3	2	1	0
Reset	0	0	0	0	0	0	0	0
Field	Reserved	IINDPM_FLAG	VINDPM_FLAG	TREG_FLAG	WD_FLAG	RESERVED	RESERVED	CHRG_FLAG

Table 24. REG0F Register Field Descriptions

Bit	Field	Type	Reset by REG_RST	Reset by WATCHDOG	Description
7	Reserved	R	Yes	No	Reserved bit always reads 0
6	IINDPM_FLAG	R	Yes	No	IINDPM Regulation $\overline{\text{INT}}$ Flag: 0 – Normal 1 – IINDPM signal rising edge detected
5	VINDPM_FLAG	R	Yes	No	VINDPM regulation $\overline{\text{INT}}$ Flag: 0 – Normal 1 – VINDPM signal rising edge detected
4	TREG_FLAG	R	Yes	No	IC Temperature Regulation $\overline{\text{INT}}$ Flag: 0 – Normal 1 – TREG signal rising edge detected
3	WD_FLAG	R	Yes	No	I2C Watchdog $\overline{\text{INT}}$ Flag: 0 – Normal 1 – WD_STAT signal rising edge detected
2	RESERVED	R	Yes	No	Reserved bit always reads 0h
1	RESERVED	R	Yes	No	Reserved bit always reads 0h
0	CHRG_FLAG	R	Yes	No	Charge Status $\overline{\text{INT}}$ Flag: 0 – Normal 1 – CHRG_STAT[2:0] bits changed (transition to any state)

8.5.17 Charger Flag 2 Register (Address = 10h) [reset = 00h]

 REG10 is shown in [Figure 44](#) and described in [Table 25](#).

 Return to [Summary Table](#).

Figure 44. REG10 Register

Bit	7	6	5	4	3	2	1	0
Reset	0	0	0	0	0	0	0	0
Field	PG_FLAG	RESERVED	RESERVED	VBUS_FLAG	RESERVED	TS_FLAG	ICO_FLAG	Reserved

Table 25. REG10 Register Field Descriptions

Bit	Field	Type	Reset by REG_RST	Reset by WATCHDOG	Description
7	PG_FLAG	R	Yes	No	Power Good $\overline{\text{INT}}$ Flag: 0 – Normal 1 – PG signal toggle detected
6	RESERVED	R	Yes	No	Reserved bit always reads 0h
5	RESERVED	R	Yes	No	Reserved bit always reads 0h
4	VBUS_FLAG	R	Yes	No	VBUS Status $\overline{\text{INT}}$ Flag: 0 – Normal 1 – VBUS_STAT[2:0] bits changed (transition to any state)
3	RESERVED	R	Yes	No	Reserved bit always reads 0h
2	TS_FLAG	R	Yes	No	TS Status $\overline{\text{INT}}$ Flag: 0 – Normal 1 – TS_STAT[2:0] bits changed (transition to any state)
1	ICO_FLAG	R	Yes	No	Input Current Optimizer (ICO) $\overline{\text{INT}}$ Flag: 0 – Normal 1 – ICO_STAT[1:0] changed (transition to any state)
0	RESERVED	R	Yes	No	Reserved bit always reads 0h

8.5.18 FAULT Flag Register (Address = 11h) [reset = 00h]

REG11 is shown in [Figure 45](#) and described in [Table 26](#).

Return to [Summary Table](#).

Figure 45. REG11 Register

Bit	7	6	5	4	3	2	1	0
Reset	0	0	0	0	0	0	0	0
Field	VBUS_OVP_FL AG	TSHUT_FLAG	Reserved	TMR_FLAG	RESERVED	RESERVED	RESERVED	Reserved

Table 26. REG11 Register Field Descriptions

Bit	Field	Type	Reset by REG_RST	Reset by WATCHDOG	Description
7	VBUS_OVP_FLAG	R	Yes	No	Input over-voltage $\overline{\text{INT}}$ Flag: 0 – Normal 1 – Entered VBUS_OVP Fault
6	TSHUT_FLAG	R	Yes	No	IC Temperature shutdown $\overline{\text{INT}}$ Flag: 0 – Normal 1 – Entered TSHUT Fault
5	RESERVED	R	Yes	No	Reserved bit always reads 0h
4	TMR_FLAG	R	Yes	No	Charge Safety timer Fault $\overline{\text{INT}}$ Flag: 0 – Normal 1 – Charge Safety timer expired rising edge detected
3	RESERVED	R	Yes	No	Reserved bit always reads 0
2	RESERVED	R	Yes	No	Reserved bit always reads 0h
1	RESERVED	R	Yes	No	Reserved bit always reads 0h
0	RESERVED	R	Yes	No	Reserved bit always reads 0h

8.5.19 Charger Mask 1 Register (Address = 12h) [reset = 00h]

REG12 is shown in [Figure 46](#) and described in [Table 27](#).

Return to [Summary Table](#).

Figure 46. REG12 Register

Bit	7	6	5	4	3	2	1	0
Reset	0	1	1	1	0	0	0	0
Field	ADC_DONE_MASK	IINDPM_MASK	VINDPM_MASK	TREG_MASK	WD_MASK	RESERVED	RESERVED	CHRG_MASK

Table 27. REG12 Register Field Descriptions

Bit	Field	Type	Reset by REG_RST	Reset by WATCHDOG	Description
7	ADC_DONE_MASK	R/W	Yes	No	ADC Conversion $\overline{\text{INT}}$ Mask Flag (only one-shot mode) 0 – ADC_DONE does produce $\overline{\text{INT}}$ pulse 1 – ADC_DONE does produce not $\overline{\text{INT}}$ pulse Reserved bit always reads 0
6	IINDPM_MASK	R/W	Yes	No	IINDPM Regulation $\overline{\text{INT}}$ Mask 0 – IINDPM entry produces $\overline{\text{INT}}$ pulse 1 – IINDPM entry does not produce $\overline{\text{INT}}$ pulse
5	VINDPM_MASK	R/W	Yes	No	VINDPM Regulation $\overline{\text{INT}}$ Mask 0 – VINDPM entry produces $\overline{\text{INT}}$ pulse 1 – VINDPM entry not produce $\overline{\text{INT}}$ pulse
4	TREG_MASK	R/W	Yes	No	IC Temperature Regulation $\overline{\text{INT}}$ Mask 0 – TREG entry produces $\overline{\text{INT}}$ pulse 1 – TREG entry produce $\overline{\text{INT}}$ pulse
3	WD_MASK	R/W	Yes	No	I2C Watchdog Timer $\overline{\text{INT}}$ Mask 0 – WD_STAT rising edge produces $\overline{\text{INT}}$ pulse 1 – WD_STAT rising edge does not produce $\overline{\text{INT}}$
2	RESERVED	R	Yes	No	Reserved bit always reads 0h
1	RESERVED	R	Yes	No	Reserved bit always reads 0h
0	CHRG_MASK	R/W	Yes	No	Charge Status $\overline{\text{INT}}$ Mask 0 – CHRG_STAT[2:0] bit change produces $\overline{\text{INT}}$ 1 – CHRG_STAT[2:0] bit change does not produce $\overline{\text{INT}}$ pulse

8.5.20 Charger Mask 2 Register (Address = 13h) [reset = 00h]

REG13 is shown in [Figure 47](#) and described in [Table 28](#).

Return to [Summary Table](#).

Figure 47. REG13 Register

Bit	7	6	5	4	3	2	1	0
Reset	0	0	0	0	0	0	0	0
Field	PG_MASK	RESERVED	RESERVED	VBUS_MASK	RESERVED	TS_MASK	ICO_MASK	Reserved

Table 28. REG13 Register Field Descriptions

Bit	Field	Type	Reset by REG_RST	Reset by WATCHDOG	Description
7	PG_MASK	R/W	Yes	No	Power Good $\overline{\text{INT}}$ Mask: 0 – PG toggle produces $\overline{\text{INT}}$ pulse 1 – PG toggle does not produce $\overline{\text{INT}}$ pulse
6	RESERVED	R	Yes	No	Reserved bit always reads 0h
5	RESERVED	R	Yes	No	Reserved bit always reads 0h
4	VBUS_MASK	R/W	Yes	No	VBUS Status $\overline{\text{INT}}$ Mask: 0 – VBUS_STAT[2:0] bit change produces $\overline{\text{INT}}$ 1 – VBUS_STAT[2:0] bit change does not produces $\overline{\text{INT}}$
3	RESERVED	R	Yes	No	Reserved bit always reads 0h
2	TS_MASK	R/W	Yes	No	TS Status $\overline{\text{INT}}$ Mask: 0 – TS_STAT[2:0] bit change produces $\overline{\text{INT}}$ 1 – TS_STAT[2:0] bit change does not produces $\overline{\text{INT}}$ pulse
1	ICO_MASK	R/W	Yes	No	Input Current Optimizer (ICO) $\overline{\text{INT}}$ Mask: 0 – ICO_STAT rising edge produces $\overline{\text{INT}}$ 1 – ICO_STAT rising edge does not produce $\overline{\text{INT}}$
0	RESERVED	R	Yes	No	Reserved bit always reads 0h

8.5.21 FAULT Mask Register (Address = 14h) [reset = 00h]

REG14 is shown in [Figure 48](#) and described in [Table 29](#).

Return to [Summary Table](#).

Figure 48. REG14 Register

Bit	7	6	5	4	3	2	1	0
Reset	0	0	0	0	0	0	0	0
Field	VBUS_OVP_M ASK	TSHUT_MASK	Reserved	TMR_MASK	SNS_SHORT_ MASK	RESERVED	RESERVED	Reserved

Table 29. REG14 Register Field Descriptions

Bit	Field	Type	Reset by REG_RST	Reset by WATCHDOG	Description
7	VBUS_OVP_MASK	R/W	Yes	No	Input over-voltage $\overline{\text{INT}}$ Mask: 0 – VBUS_OVP rising edge produces $\overline{\text{INT}}$ pulse 1 – VBUS_OVP rising edge does not produce $\overline{\text{INT}}$ pulse
6	TSHUT_MASK	R/W	Yes	No	Thermal Shutdown $\overline{\text{INT}}$ Mask: 0 – TSHUT rising edge produces $\overline{\text{INT}}$ pulse 1 – TSHUT rising edge does not produce $\overline{\text{INT}}$ pulse
5	RESERVED	R	Yes	No	Reserved bit always reads 0h
4	TMR_MASK	R/W	Yes	No	Charge Safety Timer Fault $\overline{\text{INT}}$ Mask: 0 – Timer expired rising edge produces $\overline{\text{INT}}$ pulse 1 – Timer expired rising edge does not produce $\overline{\text{INT}}$ pulse
3	SNS_SHORT_MASK	R/W	Yes	No	SNS Short Fault $\overline{\text{INT}}$ Mask: 0 – SNS short rising edge produces $\overline{\text{INT}}$ pulse 1 – SNS short rising edge does not produce $\overline{\text{INT}}$ pulse
2	RESERVED	R	Yes	No	Reserved bit always reads 0h
1	RESERVED	R	Yes	No	Reserved bit always reads 0h
0	RESERVED	R	Yes	No	Reserved bit always reads 0h

8.5.22 ADC Control Register (Address = 15h) [reset = 30h]

REG15 is shown in [Figure 49](#) and described in [Table 30](#).

Return to [Summary Table](#).

Figure 49. REG15 Register

Bit	7	6	5	4	3	2	1	0
Reset	0	0	1	1	0	0	0	0
Field	ADC_EN	ADC_RATE	ADC_SAMPLE[1:0]		RESERVED	RESERVED	RESERVED	RESERVED

Table 30. REG15 Register Field Descriptions

Bit	Field	Type	Reset by REG_RST	Reset by WATCHDOG	Description
7	ADC_EN	R/W	Yes	Yes	ADC Control: 0 – Disable ADC 1 – Enable ADC
6	ADC_RATE	R/W	Yes	No	0 – Continuous conversion 1 – One-shot conversion
5	ADC_SAMPLE[1]	R/W	Yes	No	Sample Speed of ADC: 00 – 15 bit effective resolution 01 – 14 bit effective resolution 10 – 13 bit effective resolution 11 – 12 bit effective resolution
4	ADC_SAMPLE[0]	R/W	Yes	No	
3	RESERVED	R	Yes	No	Reserved bit always reads 0h
2	RESERVED	R	Yes	No	Reserved bit always reads 0h
1	RESERVED	R	Yes	No	Reserved bit always reads 0h
0	RESERVED	R	Yes	No	Reserved bit always reads 0h

8.5.23 ADC Function Disable Register (Address = 16h) [reset = 00h]

 REG16 is shown in [Figure 50](#) and described in [Table 31](#).

 Return to [Summary Table](#).

Figure 50. REG16 Register

Bit	7	6	5	4	3	2	1	0
Reset	0	0	0	0	0	0	0	0
Field	IBUS_ADC_DIS	ICHG_ADC_D IS	VBUS_ADC_DI S	VBAT_ADC_DI S	Reserved	TS_ADC_DIS	VCELLBOT_AD C_DIS	TDIE_ADC_DIS

Table 31. REG16 Register Field Descriptions

Bit	Field	Type	Reset by REG_RST	Reset by WATCHDOG	Description
7	IBUS_ADC_DIS	R/W	Yes	No	0 – Enable conversion 1 – Disable conversion
6	ICHG_ADC_DIS	R/W	Yes	No	0 – Enable conversion 1 – Disable conversion
5	VBUS_ADC_DIS	R/W	Yes	No	0 – Enable conversion 1 – Disable conversion
4	RESERVED	R	Yes	No	Reserved bit always reads 0h
3	RESERVED	R	Yes	No	Reserved bit always reads 0h
2	TS_ADC_DIS	R/W	Yes	No	0 – Enable conversion 1 – Disable conversion
1	VCELL_ADC_DIS	R/W	Yes	No	0 – Enable conversion 1 – Disable conversion
0	TDIE_ADC_DIS	R/W	Yes	No	0 – Enable conversion 1 – Disable conversion

8.5.24 IBUS ADC 1 Register (Address = 17h) [reset = 00h]

REG17 is shown in [Figure 51](#) and described in [Table 32](#).

Return to [Summary Table](#).

Figure 51. REG17 Register

Bit	7	6	5	4	3	2	1	0
Reset	0	0	0	0	0	0	0	0
Field	IBUS_ADC[15:8]							

Table 32. REG17 Register Field Descriptions

Bit	Field	Type	Reset by REG_RST	Reset by WATCHDOG	Description
7	IBUS_ADC[15]	R	Yes	No	Sign bit: overall results reported in two's complement.
6	IBUS_ADC[14]	R	Yes	No	16384 mA
5	IBUS_ADC[13]	R	Yes	No	8192 mA
4	IBUS_ADC[12]	R	Yes	No	4096 mA
3	IBUS_ADC[11]	R	Yes	No	2048 mA
2	IBUS_ADC[10]	R	Yes	No	1024 mA
1	IBUS_ADC[9]	R	Yes	No	512 mA
0	IBUS_ADC[8]	R	Yes	No	256 mA

VBUS Current Reading (positive current flows into VBUS pin, negative current flows out of VBUS pin):
Range: 0A – 4A

8.5.25 IBUS ADC 0 Register (Address = 18h) [reset = 00h]

REG18 is shown in [Figure 52](#) and described in [Table 33](#).

Return to [Summary Table](#).

Figure 52. REG18 Register

Bit	7	6	5	4	3	2	1	0
Reset	0	0	0	0	0	0	0	0
Field	IBUS_ADC[7:0]							

Table 33. REG18 Register Field Descriptions

Bit	Field	Type	Reset by REG_RST	Reset by WATCHDOG	Description
7	IBUS_ADC[7]	R	Yes	No	128 mA
6	IBUS_ADC[6]	R	Yes	No	64 mA
5	IBUS_ADC[5]	R	Yes	No	32 mA
4	IBUS_ADC[4]	R	Yes	No	16 mA
3	IBUS_ADC[3]	R	Yes	No	8 mA
2	IBUS_ADC[2]	R	Yes	No	4 mA
1	IBUS_ADC[1]	R	Yes	No	2 mA
0	IBUS_ADC[0]	R	Yes	No	1 mA

VBUS Current Reading (positive current flows into VBUS pin, negative current flows out of VBUS pin):
Range: 0A – 4A

8.5.26 ICHG ADC 1 Register (Address = 19h) [reset = 00h]

REG19 is shown in [Figure 53](#) and described in [Table 34](#).

Return to [Summary Table](#).

Figure 53. REG19 Register

Bit	7	6	5	4	3	2	1	0
Reset	0	0	0	0	0	0	0	0
Field	RESERVED	ICHG_ADC[14:8]						

Table 34. REG19 Register Field Descriptions

Bit	Field	Type	Reset by REG_RST	Reset by WATCHDOG	Description
7	Reserved	R	Yes	No	Reserved register always reads 0h.
6	ICHG_ADC[14]	R	Yes	No	16384 mA
5	ICHG_ADC[13]	R	Yes	No	8192 mA
4	ICHG_ADC[12]	R	Yes	No	4096 mA
3	ICHG_ADC[11]	R	Yes	No	2048 mA
2	ICHG_ADC[10]	R	Yes	No	1024 mA
1	ICHG_ADC[9]	R	Yes	No	512 mA
0	ICHG_ADC[8]	R	Yes	No	256 mA

Charge Current Reading:
Range: 0A – 4A

8.5.27 ICHG ADC 0 Register (Address = 1Ah) [reset = 00h]

REG1A is shown in [Figure 54](#) and described in [Table 35](#).

Return to [Summary Table](#).

Figure 54. REG1A Register

Bit	7	6	5	4	3	2	1	0
Reset	0	0	0	0	0	0	0	0
Field	ICHG_ADC[7:0]							

Table 35. REG1A Register Field Descriptions

Bit	Field	Type	Reset by REG_RST	Reset by WATCHDOG	Description
7	ICHG_ADC[7]	R	Yes	No	128 mA
6	ICHG_ADC[6]	R	Yes	No	64 mA
5	ICHG_ADC[5]	R	Yes	No	32 mA
4	ICHG_ADC[4]	R	Yes	No	16 mA
3	ICHG_ADC[3]	R	Yes	No	8 mA
2	ICHG_ADC[2]	R	Yes	No	4 mA
1	ICHG_ADC[1]	R	Yes	No	2 mA
0	ICHG_ADC[0]	R	Yes	No	1 mA

Charge Current Reading:
Range: 0A – 4A

8.5.28 VBUS ADC 1 Register (Address = 1Bh) [reset = 00h]

REG1B is shown in [Figure 55](#) and described in [Table 36](#).

Return to [Summary Table](#).

Figure 55. REG1B Register

Bit	7	6	5	4	3	2	1	0
Reset	0	0	0	0	0	0	0	0
Field	VBUS_ADC[15:8]							

Table 36. REG1B Register Field Descriptions

Bit	Field	Type	Reset by REG_RST	Reset by WATCHDOG	Description
7	VBUS_ADC[15]	R	Yes	No	Sign bit: overall results reported in two's complement.
6	VBUS_ADC[14]	R	Yes	No	16384 mV
5	VBUS_ADC[13]	R	Yes	No	8192 mV
4	VBUS_ADC[12]	R	Yes	No	4096 mV
3	VBUS_ADC[11]	R	Yes	No	2048 mV
2	VBUS_ADC[10]	R	Yes	No	1024 mV
1	VBUS_ADC[9]	R	Yes	No	512 mV
0	VBUS_ADC[8]	R	Yes	No	256 mV

VBUS Voltage reading
Range: 0V – 10V

8.5.29 VBUS ADC 0 Register (Address = 1Ch) [reset = 00h]

REG1C is shown in [Figure 56](#) and described in [Table 37](#).

Return to [Summary Table](#).

Figure 56. REG1C Register

Bit	7	6	5	4	3	2	1	0
Reset	0	0	0	0	0	0	0	0
Field	VBUS_ADC[7:0]							

Table 37. REG1C Register Field Descriptions

Bit	Field	Type	Reset by REG_RST	Reset by WATCHDOG	Description
7	VBUS_ADC[7]	R	Yes	No	128 mV
6	VBUS_ADC[6]	R	Yes	No	64 mV
5	VBUS_ADC[5]	R	Yes	No	32 mV
4	VBUS_ADC[4]	R	Yes	No	16 mV
3	VBUS_ADC[3]	R	Yes	No	8 mV
2	VBUS_ADC[2]	R	Yes	No	4 mV
1	VBUS_ADC[1]	R	Yes	No	2 mV
0	VBUS_ADC[0]	R	Yes	No	1 mV

VBUS Voltage Reading:
Range: 0V – 10V

8.5.30 VBAT ADC 1 Register (Address = 1Dh) [reset = 00h]

REG1D is shown in [Figure 57](#) and described in [Table 38](#).

Return to [Summary Table](#).

Figure 57. REG1D Register

Bit	7	6	5	4	3	2	1	0
Reset	0	0	0	0	0	0	0	0
Field	VBAT_ADC[15:8]							

Table 38. REG1D Register Field Descriptions

Bit	Field	Type	Reset by REG_RST	Reset by WATCHDOG	Description
7	VBAT_ADC[15]	R	Yes	No	Sign bit: overall results reported in two's complement.
6	VBAT_ADC[14]	R	Yes	No	16384 mV
5	VBAT_ADC[13]	R	Yes	No	8192 mV
4	VBAT_ADC[12]	R	Yes	No	4096 mV
3	VBAT_ADC[11]	R	Yes	No	2048 mV
2	VBAT_ADC[10]	R	Yes	No	1024 mV
1	VBAT_ADC[9]	R	Yes	No	512 mV
0	VBAT_ADC[8]	R	Yes	No	256 mV

VBAT Voltage reading:
Range: 0V – 10V

8.5.31 VBAT ADC 0 Register (Address = 1Eh) [reset = 00h]

REG1E is shown in [Figure 58](#) and described in [Table 39](#).

Return to [Summary Table](#).

Figure 58. REG1E Register

Bit	7	6	5	4	3	2	1	0
Reset	0	0	0	0	0	0	0	0
Field	VBAT_ADC[7:0]							

Table 39. REG1E Register Field Descriptions

Bit	Field	Type	Reset by REG_RST	Reset by WATCHDOG	Description
7	VBAT_ADC[7]	R	Yes	No	128 mV
6	VBAT_ADC[6]	R	Yes	No	64 mV
5	VBAT_ADC[5]	R	Yes	No	32 mV
4	VBAT_ADC[4]	R	Yes	No	16 mV
3	VBAT_ADC[3]	R	Yes	No	8 mV
2	VBAT_ADC[2]	R	Yes	No	4 mV
1	VBAT_ADC[1]	R	Yes	No	2 mV
0	VBAT_ADC[0]	R	Yes	No	1 mV

VBAT Voltage reading:
Range: 0V – 10V

8.5.32 VCELLTOP ADC 1 Register (Address = 1Fh) [reset = 00h]

REG1F is shown in [Figure 59](#) and described in [Table 40](#).

Return to [Summary Table](#).

Figure 59. REG1F Register

Bit	7	6	5	4	3	2	1	0
Reset	0	0	0	0	0	0	0	0
Field	VCELLTOP_ADC[15:8]							

Table 40. REG1F Register Field Descriptions

Bit	Field	Type	Reset by REG_RST	Reset by WATCHDOG	Description
7	VCELLTOP_ADC[15]	R	Yes	No	Sign bit: overall results reported in two's complement.
6	VCELLTOP_ADC[14]	R	Yes	No	16384 mV
5	VCELLTOP_ADC[13]	R	Yes	No	8192 mV
4	VCELLTOP_ADC[12]	R	Yes	No	4096 mV
3	VCELLTOP_ADC[11]	R	Yes	No	2048 mV
2	VCELLTOP_ADC[10]	R	Yes	No	1024 mV
1	VCELLTOP_ADC[9]	R	Yes	No	512 mV
0	VCELLTOP_ADC[8]	R	Yes	No	256 mV

VCELLTOP Voltage reading:
Range: 0V – 5V
Note: cell balancing voltage measurement is measured through internal comparator. ADC reading may not reflect the actual cell balancing voltage measurement.

8.5.33 VCELLTOP ADC 0 Register (Address = 20h) [reset = 00h]

REG20 is shown in [Figure 60](#) and described in [Table 41](#).

Return to [Summary Table](#).

Figure 60. REG20 Register

Bit	7	6	5	4	3	2	1	0
Reset	0	0	0	0	0	0	0	0
Field	VCELLTOP_ADC[7:0]							

Table 41. REG20 Register Field Descriptions

Bit	Field	Type	Reset by REG_RST	Reset by WATCHDOG	Description
7	VCELLTOP_ADC[7]	R	Yes	No	128 mV
6	VCELLTOP_ADC[6]	R	Yes	No	64 mV
5	VCELLTOP_ADC[5]	R	Yes	No	32 mV
4	VCELLTOP_ADC[4]	R	Yes	No	16 mV
3	VCELLTOP_ADC[3]	R	Yes	No	8 mV
2	VCELLTOP_ADC[2]	R	Yes	No	4 mV
1	VCELLTOP_ADC[1]	R	Yes	No	2 mV
0	VCELLTOP_ADC[0]	R	Yes	No	1 mV

VCELLTOP Voltage reading:
Range: 0V – 5V
Note: cell balancing voltage measurement is measured through internal comparator. ADC reading may not reflect the actual cell balancing voltage measurement.

8.5.34 TS ADC 1 Register (Address = 21h) [reset = 00h]

REG21 is shown in [Figure 61](#) and described in [Table 42](#).

Return to [Summary Table](#).

Figure 61. REG21 Register

Bit	7	6	5	4	3	2	1	0
Reset	0	0	0	0	0	0	0	0
Field	TS_ADC[15:8]							

Table 42. REG21 Register Field Descriptions

Bit	Field	Type	Reset by REG_RST	Reset by WATCHDOG	Description
7	TS_ADC[15]	R	Yes	No	Sign bit: overall results reported in two's complement.
6	TS_ADC[14]	R	Yes	No	
5	TS_ADC[13]	R	Yes	No	
4	TS_ADC[12]	R	Yes	No	
3	TS_ADC[11]	R	Yes	No	
2	TS_ADC[10]	R	Yes	No	
1	TS_ADC[9]	R	Yes	No	50.0 %
0	TS_ADC[8]	R	Yes	No	25.0 %

TS as percentage of REGN reading:
Range: 0% – 94.9%

8.5.35 TS ADC 0 Register (Address = 22h) [reset = 00h]

REG22 is shown in [Figure 62](#) and described in [Table 43](#).

Return to [Summary Table](#).

Figure 62. REG22 Register

Bit	7	6	5	4	3	2	1	0
Reset	0	0	0	0	0	0	0	0
Field	TS_ADC[7:0]							

Table 43. REG22 Register Field Descriptions

Bit	Field	Type	Reset by REG_RST	Reset by WATCHDOG	Description
7	TS_ADC[7]	R	Yes	No	12.50 %
6	TS_ADC[6]	R	Yes	No	6.25 %
5	TS_ADC[5]	R	Yes	No	3.125 %
4	TS_ADC[4]	R	Yes	No	1.563 %
3	TS_ADC[3]	R	Yes	No	0.781 %
2	TS_ADC[2]	R	Yes	No	0.391 %
1	TS_ADC[1]	R	Yes	No	0.195 %
0	TS_ADC[0]	R	Yes	No	0.098 %

TS as percentage of REGN reading:
Range: 0% – 94.9%

8.5.36 TDIE ADC 1 Register (Address = 23h) [reset = 00h]

REG23 is shown in [Figure 63](#) and described in [Table 44](#).

Return to [Summary Table](#).

Figure 63. REG23 Register

Bit	7	6	5	4	3	2	1	0
Reset	0	0	0	0	0	0	0	0
Field	TDIE_ADC[15:8]							

Table 44. REG23 Register Field Descriptions

Bit	Field	Type	Reset by REG_RST	Reset by WATCHDOG	Description	
7	TDIE_ADC[15]	R	Yes	No	Sign bit: overall results reported in two's complement.	
6	TDIE_ADC[14]	R	Yes	No		
5	TDIE_ADC[13]	R	Yes	No		
4	TDIE_ADC[12]	R	Yes	No		
3	TDIE_ADC[11]	R	Yes	No		
2	TDIE_ADC[10]	R	Yes	No		
1	TDIE_ADC[9]	R	Yes	No		
0	TDIE_ADC[8]	R	Yes	No	128 °C	TDIE (IC Temperature) reading: Range: 0°C – 128°C

8.5.37 TDIE ADC 0 Register (Address = 24h) [reset = 00h]

REG24 is shown in [Figure 64](#) and described in [Table 45](#).

Return to [Summary Table](#).

Figure 64. REG24 Register

Bit	7	6	5	4	3	2	1	0
Reset	0	0	0	0	0	0	0	0
Field	TDIE_ADC[7:0]							

Table 45. REG24 Register Field Descriptions

Bit	Field	Type	Reset by REG_RST	Reset by WATCHDOG	Description	
7	TDIE_ADC[7]	R	Yes	No	64 °C	TDIE (IC Temperature) reading: Range: 0°C – 128°C
6	TDIE_ADC[6]	R	Yes	No	32 °C	
5	TDIE_ADC[5]	R	Yes	No	16 °C	
4	TDIE_ADC[4]	R	Yes	No	8 °C	
3	TDIE_ADC[3]	R	Yes	No	4 °C	
2	TDIE_ADC[2]	R	Yes	No	2 °C	
1	TDIE_ADC[1]	R	Yes	No	1 °C	
0	TDIE_ADC[0]	R	Yes	No	0.5 °C	

8.5.38 Part Information Register (Address = 25h) [reset = 28h]

 REG25 is shown in [Figure 65](#) and described in [Table 46](#).

 Return to [Summary Table](#).

Figure 65. REG25 Register

Bit	7	6	5	4	3	2	1	0
Reset	0	0	1	0	1	0	0	0
Field	REG_RST	PN[3:0]			DEV_REV[2:0]			

Table 46. REG25 Register Field Descriptions

Bit	Field	Type	Reset by REG_RST	Reset by WATCHDOG	Description
7	REG_RST	R	Yes	No	Register Reset: 0 – Keep current register settings 1 – Reset to default register value and reset safety timer (bit resets to 0 after register reset is complete)
6	PN[3]	R	Yes	No	0101: BQ25887
5	PN[2]	R	Yes	No	
4	PN[1]	R	Yes	No	
3	PN[0]	R	Yes	No	
2	DEV_REV[2]	R	Yes	No	Device revision: 001
1	DEV_REV[1]	R	Yes	No	
0	DEV_REV[0]	R	Yes	No	

8.5.39 VCELLBOT ADC 1 Register (Address = 26h) [reset = 00h]

REG26 is shown in [Figure 66](#) and described in [Table 47](#).

Return to [Summary Table](#).

Figure 66. REG26 Register

Bit	7	6	5	4	3	2	1	0
Reset	0	0	0	0	0	0	0	0
Field	VCELLBOT_ADC[15:8]							

Table 47. REG26 Register Field Descriptions

Bit	Field	Type	Reset by REG_RST	Reset by WATCHDOG	Description
7	VCELLBOT_ADC[15]	R	Yes	No	Sign bit: overall results reported in two's complement.
6	VCELLBOT_ADC[14]	R	Yes	No	16384 mV
5	VCELLBOT_ADC[13]	R	Yes	No	8192 mV
4	VCELLBOT_ADC[12]	R	Yes	No	4096 mV
3	VCELLBOT_ADC[11]	R	Yes	No	2048 mV
2	VCELLBOT_ADC[10]	R	Yes	No	1024 mV
1	VCELLBOT_ADC[9]	R	Yes	No	512 mV
0	VCELLBOT_ADC[8]	R	Yes	No	256 mV

Bottom Cell Voltage from MID to GND Voltage reading:
Range: 0V – 5V

8.5.40 VCELLBOT ADC 0 Register (Address = 27h) [reset = 00h]

REG27 is shown in [Figure 67](#) and described in [Table 48](#).

Return to [Summary Table](#).

Figure 67. REG27 Register

Bit	7	6	5	4	3	2	1	0
Reset	0	0	0	0	0	0	0	0
Field	VCELLBOT_ADC[7:0]							

Table 48. REG27 Register Field Descriptions

Bit	Field	Type	Reset by REG_RST	Reset by WATCHDOG	Description
7	VCELLBOT_ADC[7]	R	Yes	No	128 mV
6	VCELLBOT_ADC[6]	R	Yes	No	64 mV
5	VCELLBOT_ADC[5]	R	Yes	No	32 mV
4	VCELLBOT_ADC[4]	R	Yes	No	16 mV
3	VCELLBOT_ADC[3]	R	Yes	No	8 mV
2	VCELLBOT_ADC[2]	R	Yes	No	4 mV
1	VCELLBOT_ADC[1]	R	Yes	No	2 mV
0	VCELLBOT_ADC[0]	R	Yes	No	1 mV

Bottom Cell Voltage from MID to GND Voltage reading:
Range: 0V – 10V

8.5.41 Cell Balancing Control 1 Register (Address = 28h) [reset = 2Ah]

REG28 is shown in [Figure 68](#) and described in [Table 49](#).

Return to [Summary Table](#).

Figure 68. REG28 Register

Bit	7	6	5	4	3	2	1	0
Reset	0	0	1	0	1	0	1	0
Field	VDIFF_END_OFFSET[2:0]		TCB_QUAL_IN TERVAL		TCB_ACTIVE[1:0]		TSETTLE[1:0]	

Table 49. REG28 Register Field Descriptions

Bit	Field	Type	Reset by REG_RST	Reset by WATCHDOG	Description
7	VDIFF_END_OFFSET[2]	R/W	Yes	No	Cell balancing exit threshold is programmed as an offset from the VDIFF_START. Range is 30mV to 100mV with 10mV resolution. Note that VDIFF_END_OFFSET should be less than the selected VDIFF_START. VDIFF_END = VDIFF_START – VDIFF_END_OFFSET. If VDIFF_END is less than 10mV, then the charger should clamp VDIFF_END to 10mV. 000 – 30mV 001 – 40mV (Default) 010 – 50mV 011 – 60mV 100 – 70mV 101 – 80mV 110 – 90mV 111 – 100mV
6	VDIFF_END_OFFSET[1]	R/W	Yes	No	
5	VDIFF_END_OFFSET[0]	R/W	Yes	No	
4	TCB_QUAL_INTERVAL	R/W	Yes	No	Options for the interval between taking measurements to enter cell balancing mode: 0 – 2 min (default) 1 – 4 min
3	TCB_ACTIVE[1]	R/W	Yes	No	Register to select time interval to stop charging and cell balancing discharging for cell voltage measurements 00 – 4s 01 – 32 s 10 – 2 min (default) 11 – 4 min
2	TCB_ACTIVE[0]	R/W	Yes	No	
1	TSETTLE[1]	R/W	Yes	No	Register to set delay between charge disable and voltage measurement. 00 – 10 ms 01 – 100 ms 10 – 1s (default) 11 – 2s
0	TSETTLE[0]	R/W	Yes	No	

8.5.42 Cell Balancing Control 2 Register (Address = 29h) [reset = F4h]

REG29 is shown in [Figure 69](#) and described in [Table 50](#).

Return to [Summary Table](#).

Figure 69. REG29 Register

Bit	7	6	5	4	3	2	1	0
Reset	1	1	1	1	0	1	0	0
Field	VQUAL_TH				VDIFF_START			

Table 50. REG29 Register Field Descriptions

Bit	Field	Type	Reset by REG_RST	Reset by WATCHDOG	Description
7	VQUAL_TH [3]	R/W	Yes	No	80 mV
6	VQUAL_TH [2]	R/W	Yes	No	40 mV
5	VQUAL_TH [1]	R/W	Yes	No	20 mV
4	VQUAL_TH [0]	R/W	Yes	No	10 mV
3	VDIFF_START [3]	R/W	Yes	No	80 mV
2	VDIFF_START [2]	R/W	Yes	No	40 mV
1	VDIFF_START [0]	R/W	Yes	No	20 mV
0	VDIFF_START [1]	R/W	Yes	No	10 mV

The threshold from cell balancing pre-qualification mode to cell balancing qualification mode. This is the differential threshold between the two cells when charging is enabled. Offset is 40mV. Range from 40mV to 180mV with 10mV step.

0000 – 40mV
0001 – 50mV
0010 – 60mV
0011 – 70mV
0100 – 80mV
0101 – 90mV
0110 – 100mV
0111 – 110mV
1000 – 120mV
1001 – 130mV
1010 – 140mV
1011 – 150mV
1100: 160mV
1101 – 170mV
1110 – 180mV
1111 – Disable pre-qualification (Default)

The threshold from cell balancing qualification mode to cell balancing active mode. This is the differential threshold between the two cells when charging is enabled. Offset is 40mV. Range from 40mV to 190mV with 10mV step. Default VDIFF_START is 0100 (80mV)

0000 – 40mV
0001 – 50mV
0010 – 60mV
0011 – 70mV
0100 – 80mV (Default)
0101 – 90mV
0110 – 100mV
0111 – 110mV
1000 – 120mV
1001 – 130mV
1010 – 140mV
1011 – 150mV
1100 – 160mV
1101 – 170mV
1110 – 180mV
1111 – 190mV

ADVANCE INFORMATION

8.5.43 Cell Balancing Status and Control Register (Address = 2Ah) [reset = 81h]

 REG29 is shown in [Figure 70](#) and described in [Table 51](#).

 Return to [Summary Table](#).

Figure 70. REG2A Register

Bit	7	6	5	4	3	2	1	0
Reset	1	1	0	0	0	0	0	0
Field	CB_CHG_DIS	CB_AUTO_EN	CB_STAT	HS_CV_STAT	LS_CV_STAT	HS_OV_STAT	LS_OV_STAT	CB_OC_STAT

Table 51. REG2A Register Field Descriptions

Bit	Field	Type	Reset by REG_RST	Reset by WATCHDOG	Description
7	CB_CHG_DIS	R/W	Yes	No	Bit to disable charge for accurate cell balancing measurement. CB discharge will still be disabled for measurement. 0 – Charge is continuous during cell balancing cell voltage measurement 1 – Charge is disabled during cell balancing cell voltage measurement. (Default)
6	CB_AUTO_EN	R/W	Yes	No	Bit to enable automatic cell balancing mode. This bit must be low to allow the manual cell discharge function. 0 – Disable auto cell balancing 1 – Enable auto cell balancing (Default)
5	CB_STAT	R	Yes	No	Anytime cell balance is active, the is bit is set to high. Once cell balance is exit, this bit returns to low. 0 – Cell balance not active or cell balance is exit. 1 – Cell balance active mode.
4	HS_CV_STAT	R	Yes	No	If this bit is set, the high side cell is in CV mode
3	LS_CV_STAT	R	Yes	No	If this bit is set, the low side cell is in CV mode
2	HS_OV_STAT	R	Yes	No	If this bit is set, the high side cell is in over-voltage
1	LS_OV_STAT	R	Yes	No	If this bit is set, the low side cell is in over-voltage
0	CB_OC_STAT	R	Yes	No	If this bit is set, the Cell Balance Over-Current Protection is active

8.5.44 Cell Balancing Flag Register (Address = 2Bh) [reset = 00h]

REG2A is shown in [Figure 71](#) and described in [Table 52](#).

Return to [Summary Table](#).

Figure 71. REG2B Register

Bit	7	6	5	4	3	2	1	0
Reset	0	0	0	0	0	0	0	0
Field	QCBH_EN	QCBL_EN	CB_FLAG	HS_CV_FLAG	LS_CV_FLAG	HS_OV_FLAG	LS_OV_FLAG	CB_OC_FLAG

Table 52. REG2B Register Field Descriptions

Bit	Field	Type	Reset by REG_RST	Reset by WATCHDOG	Description
7	QCBH_EN	R/W	Yes	No	Bit to turn on QCBH to discharge the top cell. 0 – Turn off QCBH (Default) 1 – Turn on QCBH
6	QCBL_EN	R/W	Yes	No	Bit to turn on QCBL to discharge the bottom cell. 0 – Turn off QCBL (Default) 1 – Turn on QCBL
5	CB_FLAG	R	Yes	No	Cell balancing status $\overline{\text{INT}}$ Flag 0 – Normal 1 – Entered or exited cell balancing
4	HS_CV_FLAG	R	Yes	No	If this bit is set, the high side cell balancing FET is in CV mode, or has been in CV mode. This bit is cleared upon read.
3	LS_CV_FLAG	R	Yes	No	If this bit is set, the low side cell balancing FET is in CV mode, or has been in CV mode. This bit is cleared upon read.
2	HS_OV_FLAG	R	Yes	No	If this bit is set, the high side cell is in over-voltage, or has been in over-voltage. This bit is cleared upon read.
1	LS_OV_FLAG	R	Yes	No	If this bit is set, the low side cell is in over-voltage, or has been in over-voltage. This bit is cleared upon read.
0	CB_OC_FLAG	R	Yes	No	If this bit is set, the Cell Balance Over-Current Protection is active, or has been active. This bit is cleared upon read.

8.5.45 Cell Balancing Mask Register (Address = 2Ch) [reset = 00h]

REG2B is shown in [Figure 72](#) and described in [Table 53](#).

Return to [Summary Table](#).

Figure 72. REG2C Register

Bit	7	6	5	4	3	2	1	0
Reset	0	0	0	0	0	0	0	0
Field	Reserved	Reserved	CB_MASK	HS_CV_MASK	LS_CV_MASK	HS_OV_MASK	LS_OV_MASK	CB_OC_MASK

Table 53. REG2C Register Field Descriptions

Bit	Field	Type	Reset by REG_RST	Reset by WATCHDOG	Description
7	Reserved	R	Yes	No	Reserved bit always reads 0h
6	Reserved	R	Yes	No	Reserved bit always reads 0h
5	CB_MASK	R/W	Yes	No	When set, the device will not send an interrupt on the $\overline{\text{INT}}$ pin when the device enters or exits cell balance mode.
4	HS_CV_MASK	R/W	Yes	No	When set, the device will not send an interrupt on the $\overline{\text{INT}}$ pin when the high side cell balancing FET is in CV mode.
3	LS_CV_MASK	R/W	Yes	No	When set, the device will not send an interrupt on the $\overline{\text{INT}}$ pin when the low side cell balancing FET is in CV mode.
2	HS_OV_MASK	R/W	Yes	No	When set, the device will not send an interrupt on the $\overline{\text{INT}}$ pin when the high side cell is in over-voltage.
1	LS_OV_MASK	R/W	Yes	No	When set, the device will not send an interrupt on the $\overline{\text{INT}}$ pin when the low side cell is in over-voltage.
0	CB_OC_MASK	R/W	Yes	No	When set, the device will not send an interrupt on the $\overline{\text{INT}}$ pin when the Cell Balance Over-Current Protections is active.

9 Application and Implementation

NOTE

Information in the following applications sections is not part of the TI component specification, and TI does not warrant its accuracy or completeness. TI's customers are responsible for determining suitability of components for their purposes. Customers should validate and test their design implementation to confirm system functionality.

9.1 Application Information

A typical application consists of the BQ25887 configured as an I2C controlled device and a 2s battery charger with cell balancing for Li-Ion and Li-polymer batteries used in a wide range of E-cig and other portable devices. It integrates an input blocking FET (QBLK, Q1), high-side switching FET (QHS, Q2), and low-side switching FET (QLS, Q3). The device also integrates a bootstrap diode for the high-side gate drive.

9.2 Typical Application

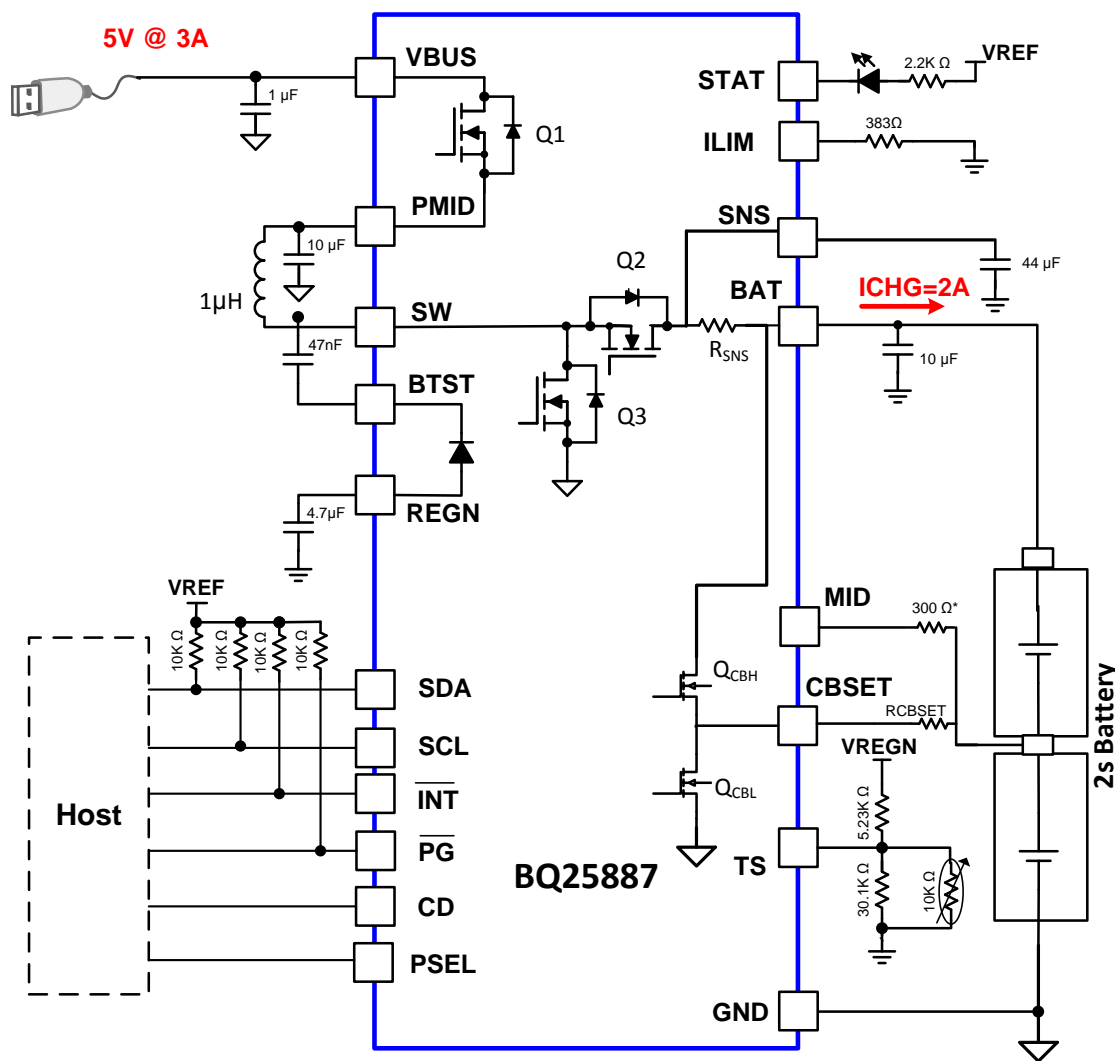

*Note: 300Ω resistor on MID pin is used to limit the current in the case where the bottom cell is plugged in reversly

Figure 73. BQ25887 (Cell Balancing and I2C) Typical Application Diagram

Typical Application (continued)

9.2.1 Design Requirements

For this design example, use the parameters shown in the table below

Table 54. Design Parameters

PARAMETER	VALUE
V _{BUS} voltage range	3.9 V to 6.2 V
Input current limit (I _{INDPM} [4:0])	2.4 A
Fast charge current limit (I _{CHG} [5:0])	1.5 A
Battery Regulation Voltage (V _{CELLREG} [7:0])	4.2 V

9.2.2 Detailed Design Procedure

9.2.2.1 Inductor Selection

The device has 1.5MHz switching frequency to allow the use of small inductor and capacitor values. The inductor saturation current should be higher than the input current (I_{IN}) plus half the ripple current (I_{RIPPLE}):

$$I_{SAT} \geq I_{IN} + \frac{I_{RIPPLE}}{2} \quad (5)$$

The inductor ripple current (I_{RIPPLE}) depends on input voltage (V_{BUS}), duty cycle (D = V_{BAT}/V_{BUS}), switching frequency (f_{SW}) and inductance (L):

$$I_{RIPPLE} = \frac{V_{BUS} \times (V_{SYS} - V_{BUS})}{V_{SYS} \times f_{SW} \times L} \quad (6)$$

The maximum inductor ripple current happens in the vicinity of D = 0.5. Usually inductor ripple is designed in the range of (20 – 40%) maximum charging current as a trade-off between inductor size and efficiency for a practical design.

9.2.2.2 Input (V_{BUS} / PMID) Capacitor

Input capacitor should have enough ripple current rating to absorb input switching ripple current. The worst case RMS ripple current occurs when duty cycle is 0.5. If the converter does not operate at 50% duty cycle, then the worst case capacitor RMS current I_{PMID} occurs where the duty cycle is closest to 50% and can be estimated by

$$I_{PMID} = \frac{I_{RIPPLE}}{2 \times \sqrt{3}} \approx 0.29 \times I_{RIPPLE} \quad (7)$$

Low ESR ceramic capacitor such as X7R or X5R is preferred for input decoupling capacitor and should be placed close to the PMID and GND pins of the IC. Voltage rating of the capacitor must be higher than normal input voltage level. 25-V rating or higher capacitor is preferred for up to 5-V input voltage. 10-μF capacitor is suggested for up to 3.3-A input current.

9.2.2.3 Output (V_{SYS}) Capacitor

SYS capacitor is the boost converter output capacitor and should also have enough ripple current rating to absorb output switching ripple current. The output capacitor RMS current I_{CO_{UT}} is given:

$$I_{CSYS} = I_{IN} \times \sqrt{\frac{V_{SYS}}{V_{BUS}} - \frac{V_{SYS}^2}{V_{BUS}^2}} \quad (8)$$

The output capacitor voltage ripple is a function of the boost output current (I_{OUT}), and can be calculated as follows:

$$\Delta V_{SYS} = \frac{I_{OUT} \times D}{f_{SW} \times C_{SYS}} \quad (9)$$

BQ25887

SLUSD89 – FEBRUARY 2019

www.ti.com

Low ESR ceramic capacitor such as X7R or X5R is preferred for SYS decoupling capacitor and should be placed close to the SYS and GND pins of the IC. Voltage rating of the capacitor must be higher than normal output voltage level. 16-V rating or higher capacitor is preferred. 44- μ F capacitor is suggested for up to 2.2-A boost converter output current.

ADVANCE INFORMATION

9.2.3 Application Curves

$C_{VBUS} = 1\mu\text{F}$, $C_{PMID} = 10\mu\text{F}$, $C_{BAT} = 10\mu\text{F}$, $C_{SYS} = 44\mu\text{F}$, $L = \text{DFE252012F-1R0}$ ($1\mu\text{H}$) (unless otherwise specified)

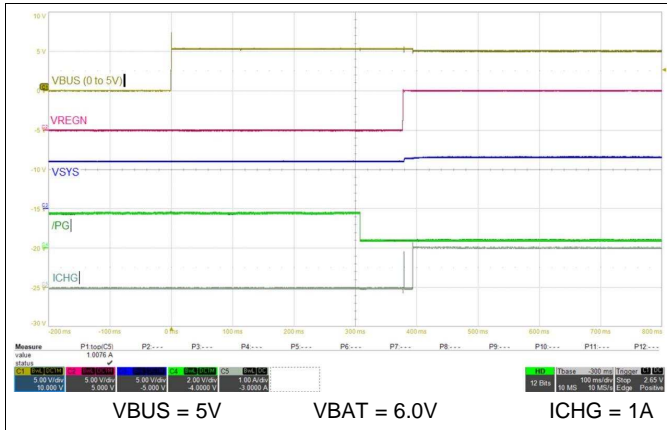

Figure 74. Adapter Power Up with Charge Enabled

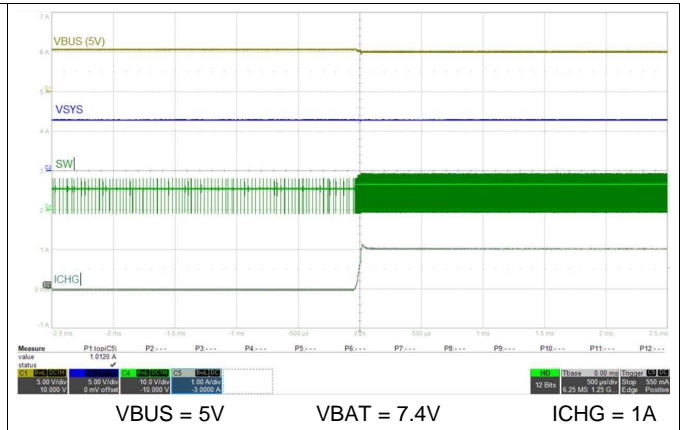

Figure 75. Charge Enable

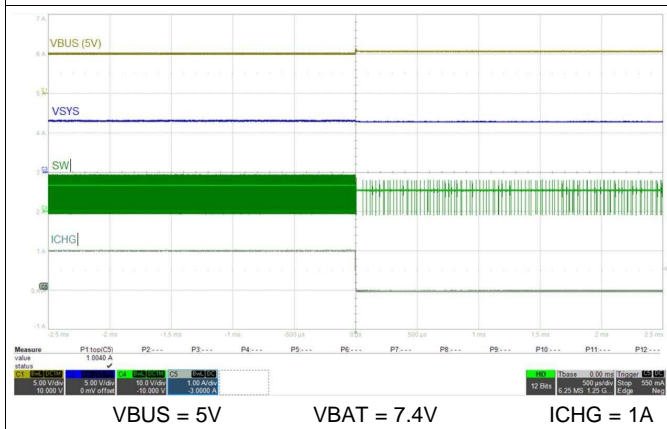

Figure 76. Charge Disabled

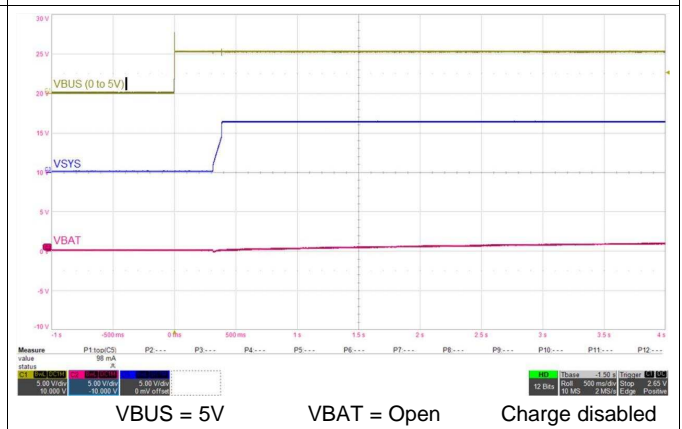

Figure 77. Adapter Plug-in with No Battery Charge Disabled

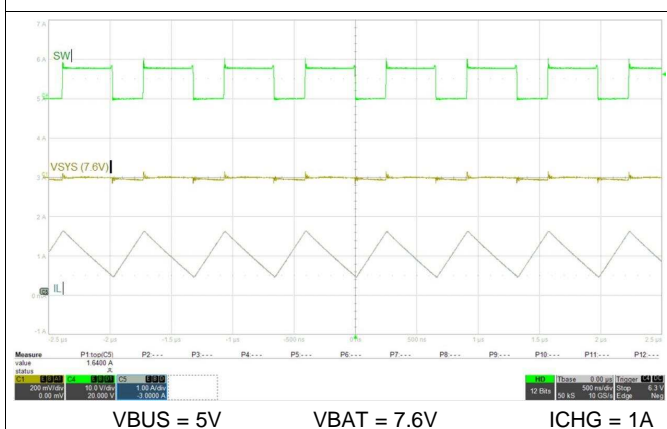

Figure 78. Boost Mode PWM Switching

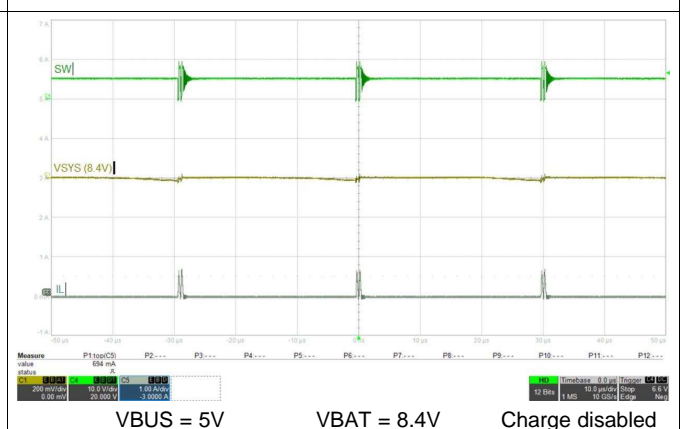
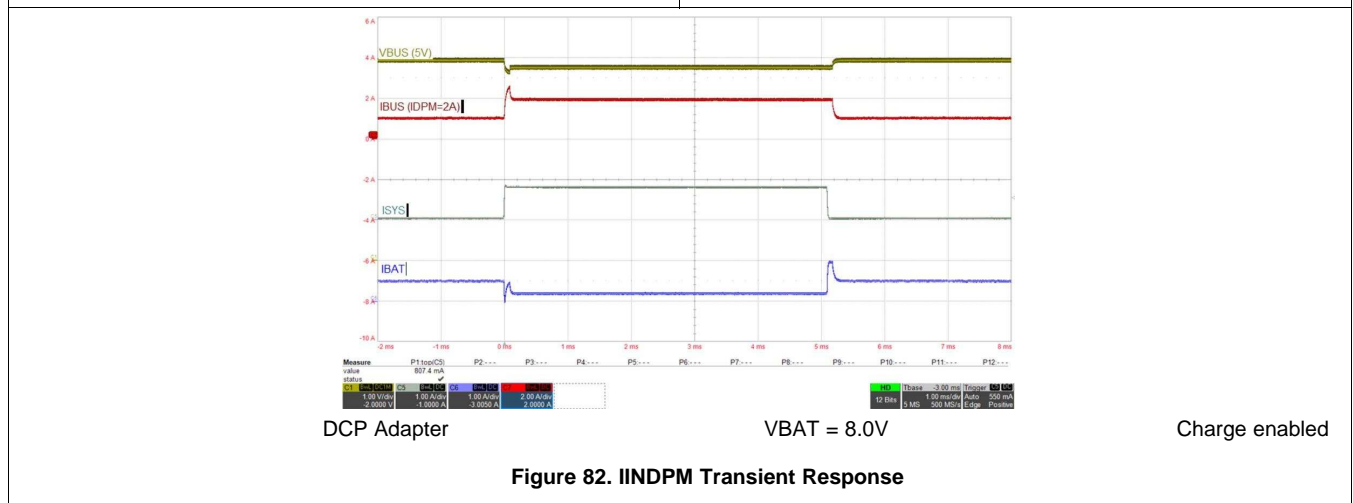
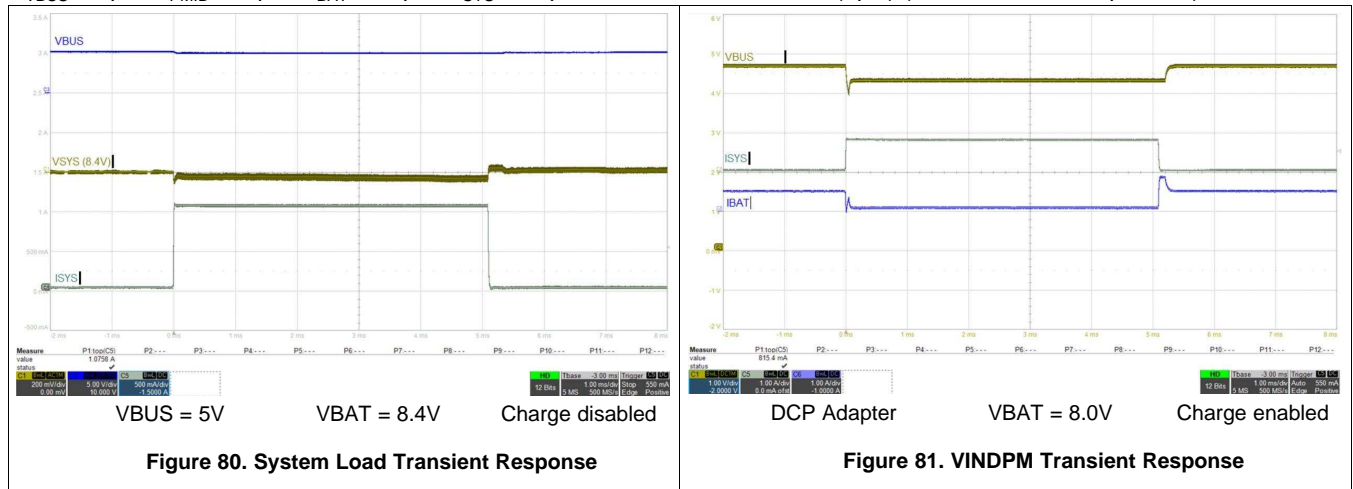

Figure 79. Boost Mode PFM Switching

ADVANCE INFORMATION

$C_{VBUS} = 1\mu\text{F}$, $C_{PMID} = 10\mu\text{F}$, $C_{BAT} = 10\mu\text{F}$, $C_{SYS} = 44\mu\text{F}$, $L = \text{DFE252012F-1R0}$ ($1\mu\text{H}$) (unless otherwise specified)



ADVANCE INFORMATION

10 Power Supply Recommendations

In order to provide an output voltage, the device requires a power supply between 3.9 V and 6.2 V input with at least 500-mA current rating connected to VBUS or a 2s Li-Ion battery with voltage > VBAT_UVLO connected to BAT.

11 Layout

11.1 Layout Guidelines

The switching node rise and fall times should be minimized for minimum switching loss. Proper layout of the components to minimize high frequency current path loops is important to prevent electrical and magnetic field radiation and high frequency resonant problems. Here is a PCB layout priority list for proper layout. Layout PCB according to this specific order is essential.

1. Put SYS output capacitor as close to SYS and GND pins as possible. Ground connections need to be tied to the IC ground with a short copper trace connection or GND plane.
2. Place PMID input capacitor as close as possible to PMID pins and PGND pins and use shortest copper trace connection or GND plane.
3. Place inductor input terminal to SW pins as close as possible. Minimize the copper area of this trace to lower electrical and magnetic field radiation but make the trace wide enough to carry the input current. Minimize parasitic capacitance from this area to any other trace or plane.
4. Decoupling capacitors should be placed on the same side of and next to the IC and make trace connection as short as possible.
5. Route analog ground separately from power ground. Connect analog ground and connect power ground separately. Connect analog ground and power ground together using thermal pad as the single ground connection point. Or using a 0-Ω resistor to tie analog ground to power ground.
6. It is critical that the exposed thermal pad on the backside of the device package be soldered to the PCB ground. Ensure that there are sufficient thermal vias directly under the IC, connecting to the ground plane on the other layers.
7. Via size and number should be enough for a given current path.
8. Route MID as sensing trace away from switching nodes such as SW.

Refer to the EVM design and the [Layout Example](#) below for the recommended component placement with trace and via locations.

11.2 Layout Example

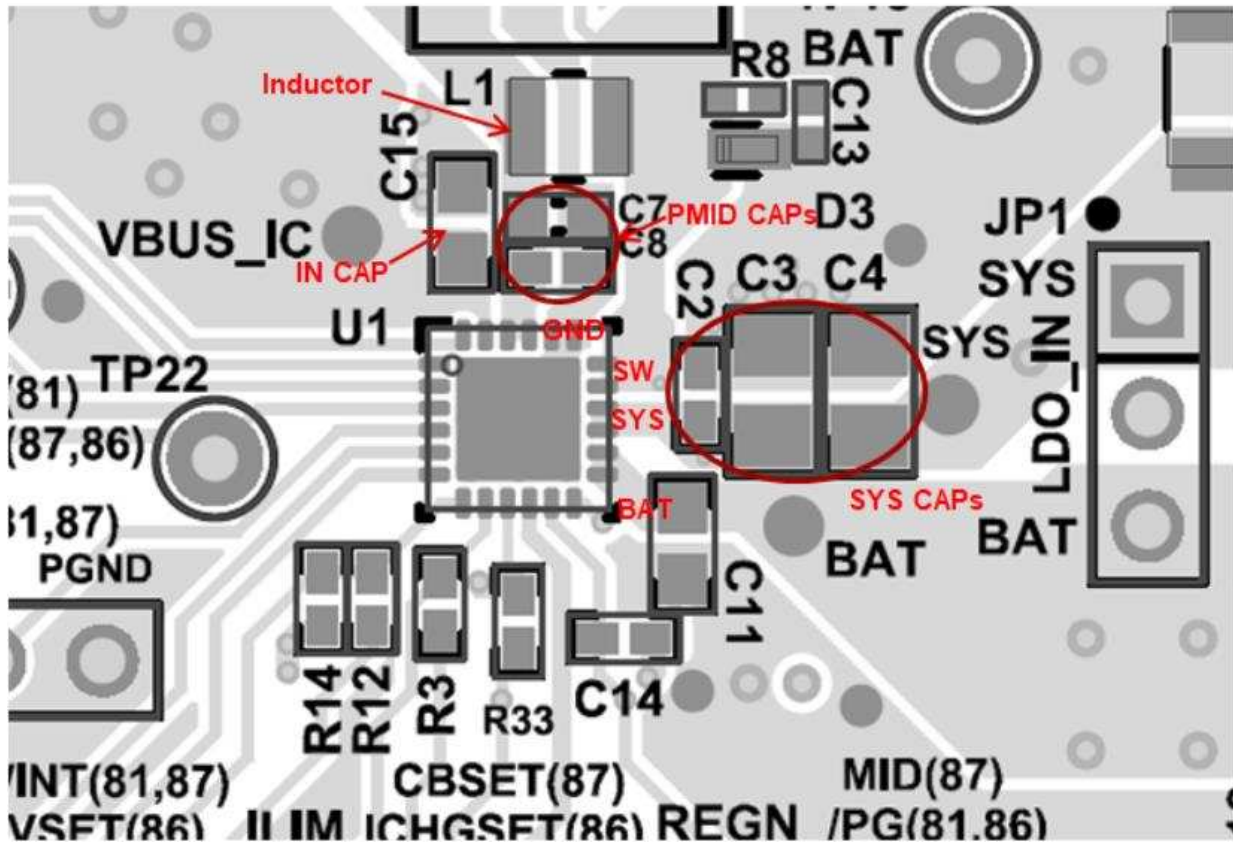

Figure 83. PCB Layout Example

ADVANCE INFORMATION

12 Device and Documentation Support

12.1 Device Support

12.1.1 Third-Party Products Disclaimer

TI'S PUBLICATION OF INFORMATION REGARDING THIRD-PARTY PRODUCTS OR SERVICES DOES NOT CONSTITUTE AN ENDORSEMENT REGARDING THE SUITABILITY OF SUCH PRODUCTS OR SERVICES OR A WARRANTY, REPRESENTATION OR ENDORSEMENT OF SUCH PRODUCTS OR SERVICES, EITHER ALONE OR IN COMBINATION WITH ANY TI PRODUCT OR SERVICE.

12.2 Documentation Support

12.2.1 Related Documentation

For related documentation see the following:

- *BQ2588x EVM User's Guide (SLUUBU6)*

12.3 Receiving Notification of Documentation Updates

To receive notification of documentation updates, navigate to the device product folder on ti.com. In the upper right corner, click on *Alert me* to register and receive a weekly digest of any product information that has changed. For change details, review the revision history included in any revised document.

12.4 Community Resources

The following links connect to TI community resources. Linked contents are provided "AS IS" by the respective contributors. They do not constitute TI specifications and do not necessarily reflect TI's views; see TI's [Terms of Use](#).

TI E2E™ Online Community *TI's Engineer-to-Engineer (E2E) Community*. Created to foster collaboration among engineers. At e2e.ti.com, you can ask questions, share knowledge, explore ideas and help solve problems with fellow engineers.

Design Support *TI's Design Support* Quickly find helpful E2E forums along with design support tools and contact information for technical support.

12.5 Trademarks

E2E is a trademark of Texas Instruments.
All other trademarks are the property of their respective owners.

12.6 Electrostatic Discharge Caution



This integrated circuit can be damaged by ESD. Texas Instruments recommends that all integrated circuits be handled with appropriate precautions. Failure to observe proper handling and installation procedures can cause damage.

ESD damage can range from subtle performance degradation to complete device failure. Precision integrated circuits may be more susceptible to damage because very small parametric changes could cause the device not to meet its published specifications.

12.7 Glossary

SLYZ022 — *TI Glossary*.

This glossary lists and explains terms, acronyms, and definitions.

13 Mechanical, Packaging, and Orderable Information

The following pages include mechanical, packaging, and orderable information. This information is the most current data available for the designated devices. This data is subject to change without notice and revision of this document. For browser-based versions of this data sheet, refer to the left-hand navigation.

PACKAGING INFORMATION

Orderable Device	Status (1)	Package Type	Package Drawing	Pins	Package Qty	Eco Plan (2)	Lead/Ball Finish (6)	MSL Peak Temp (3)	Op Temp (°C)	Device Marking (4/5)	Samples
BQ25887RGER	PREVIEW	VQFN	RGE	24	3000	Green (RoHS & no Sb/Br)	CU NIPDAU	Level-2-260C-1 YEAR	-40 to 85	BQ25887	
BQ25887RGET	PREVIEW	VQFN	RGE	24	250	TBD	Call TI	Call TI	-40 to 85		
PQ25887RGET	ACTIVE	VQFN	RGE	24	250	TBD	Call TI	Call TI	-40 to 85		Samples

(1) The marketing status values are defined as follows:

ACTIVE: Product device recommended for new designs.

LIFEBUY: TI has announced that the device will be discontinued, and a lifetime-buy period is in effect.

NRND: Not recommended for new designs. Device is in production to support existing customers, but TI does not recommend using this part in a new design.

PREVIEW: Device has been announced but is not in production. Samples may or may not be available.

OBSOLETE: TI has discontinued the production of the device.

(2) **RoHS:** TI defines "RoHS" to mean semiconductor products that are compliant with the current EU RoHS requirements for all 10 RoHS substances, including the requirement that RoHS substance do not exceed 0.1% by weight in homogeneous materials. Where designed to be soldered at high temperatures, "RoHS" products are suitable for use in specified lead-free processes. TI may reference these types of products as "Pb-Free".

RoHS Exempt: TI defines "RoHS Exempt" to mean products that contain lead but are compliant with EU RoHS pursuant to a specific EU RoHS exemption.

Green: TI defines "Green" to mean the content of Chlorine (Cl) and Bromine (Br) based flame retardants meet JS709B low halogen requirements of <=1000ppm threshold. Antimony trioxide based flame retardants must also meet the <=1000ppm threshold requirement.

(3) MSL, Peak Temp. - The Moisture Sensitivity Level rating according to the JEDEC industry standard classifications, and peak solder temperature.

(4) There may be additional marking, which relates to the logo, the lot trace code information, or the environmental category on the device.

(5) Multiple Device Markings will be inside parentheses. Only one Device Marking contained in parentheses and separated by a "~" will appear on a device. If a line is indented then it is a continuation of the previous line and the two combined represent the entire Device Marking for that device.

(6) Lead/Ball Finish - Orderable Devices may have multiple material finish options. Finish options are separated by a vertical ruled line. Lead/Ball Finish values may wrap to two lines if the finish value exceeds the maximum column width.

Important Information and Disclaimer:The information provided on this page represents TI's knowledge and belief as of the date that it is provided. TI bases its knowledge and belief on information provided by third parties, and makes no representation or warranty as to the accuracy of such information. Efforts are underway to better integrate information from third parties. TI has taken and continues to take reasonable steps to provide representative and accurate information but may not have conducted destructive testing or chemical analysis on incoming materials and chemicals. TI and TI suppliers consider certain information to be proprietary, and thus CAS numbers and other limited information may not be available for release.

In no event shall TI's liability arising out of such information exceed the total purchase price of the TI part(s) at issue in this document sold by TI to Customer on an annual basis.

RGE 24

GENERIC PACKAGE VIEW

VQFN - 1 mm max height

PLASTIC QUAD FLATPACK - NO LEAD



Images above are just a representation of the package family, actual package may vary.
Refer to the product data sheet for package details.

4204104/H

RGE0024H

PACKAGE OUTLINE

VQFN - 1 mm max height

PLASTIC QUAD FLATPACK- NO LEAD

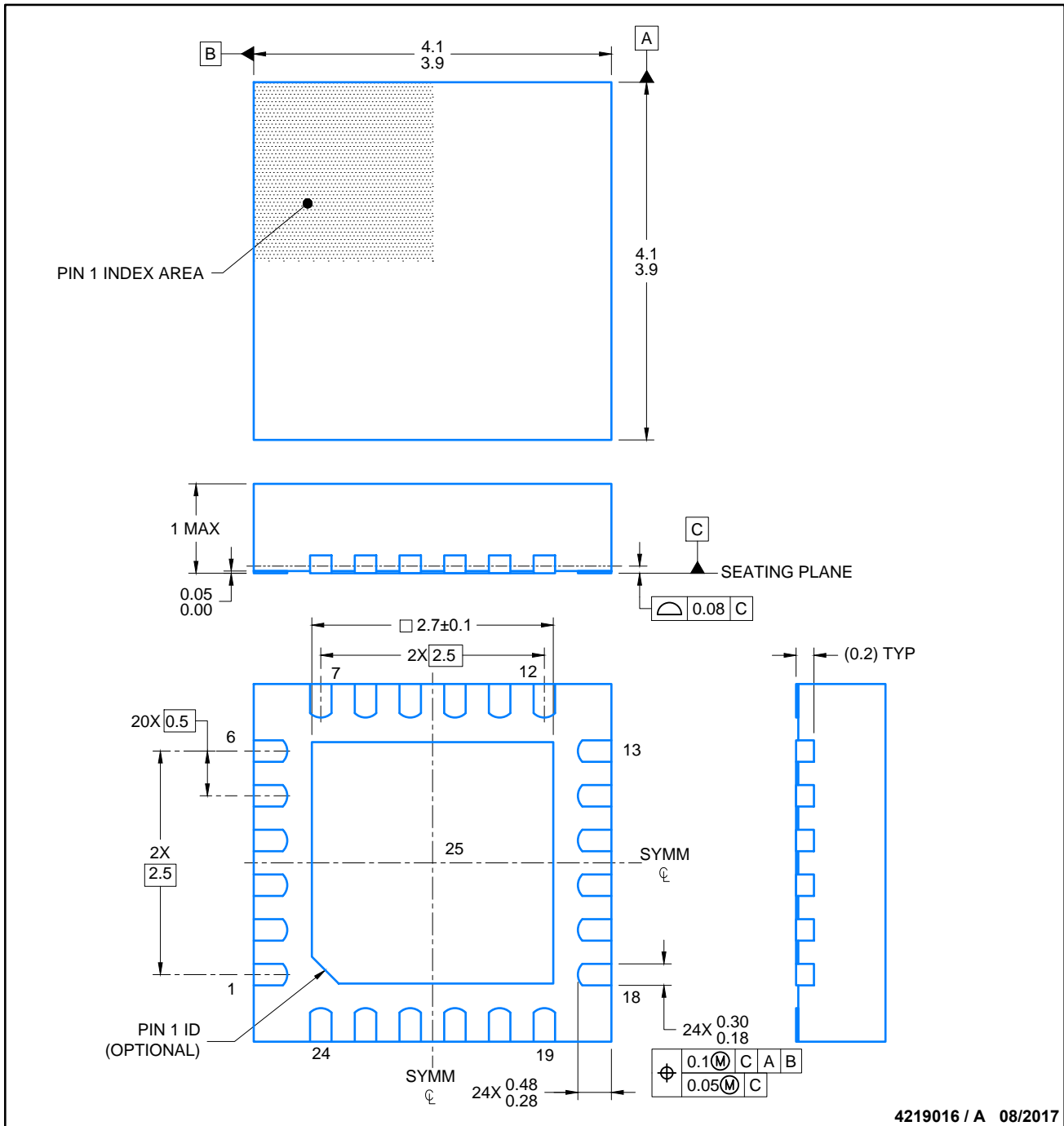

NOTES:

1. All linear dimensions are in millimeters. Any dimensions in parenthesis are for reference only. Dimensioning and tolerancing per ASME Y14.5M.
2. This drawing is subject to change without notice.
3. The package thermal pad must be soldered to the printed circuit board for thermal and mechanical performance.

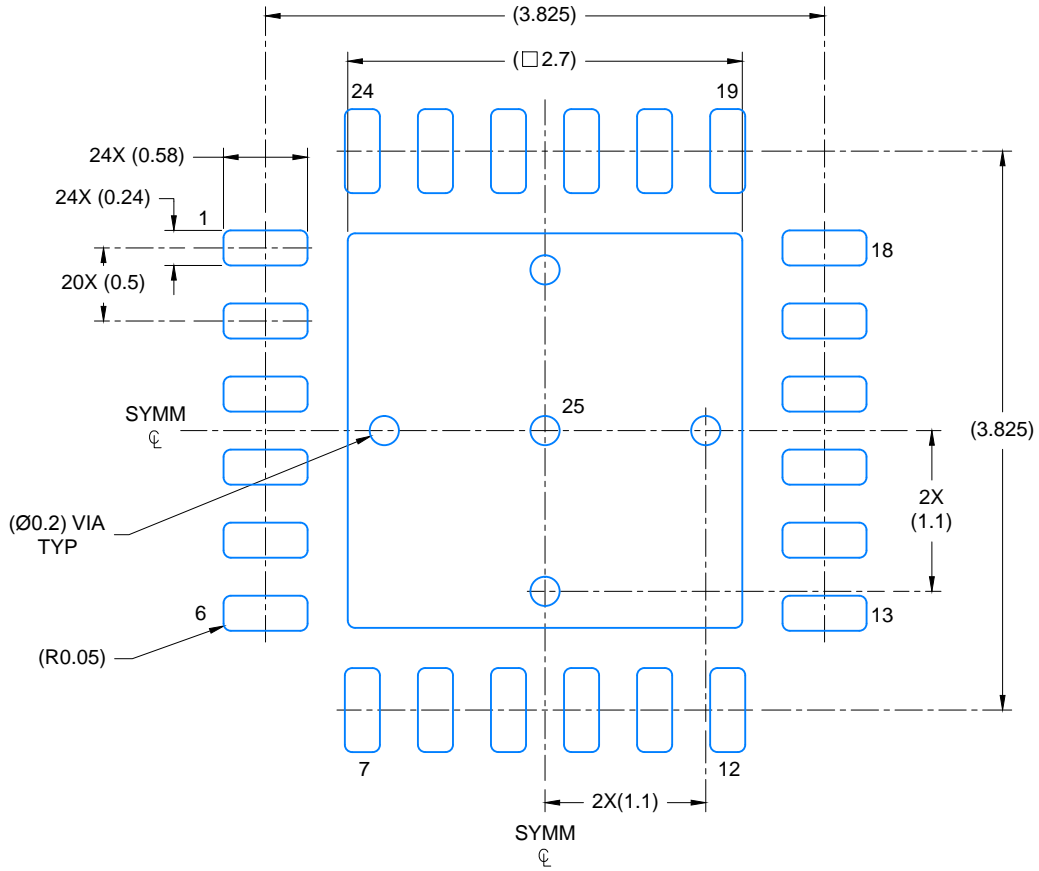

LAND PATTERN EXAMPLE
SCALE: 20X



4219016 / A 08/2017

NOTES: (continued)

4. This package is designed to be soldered to a thermal pad on the board. For more information, see Texas Instruments literature number SLUA271 (www.ti.com/lit/slua271).
5. Solder mask tolerances between and around signal pads can vary based on board fabrication site.

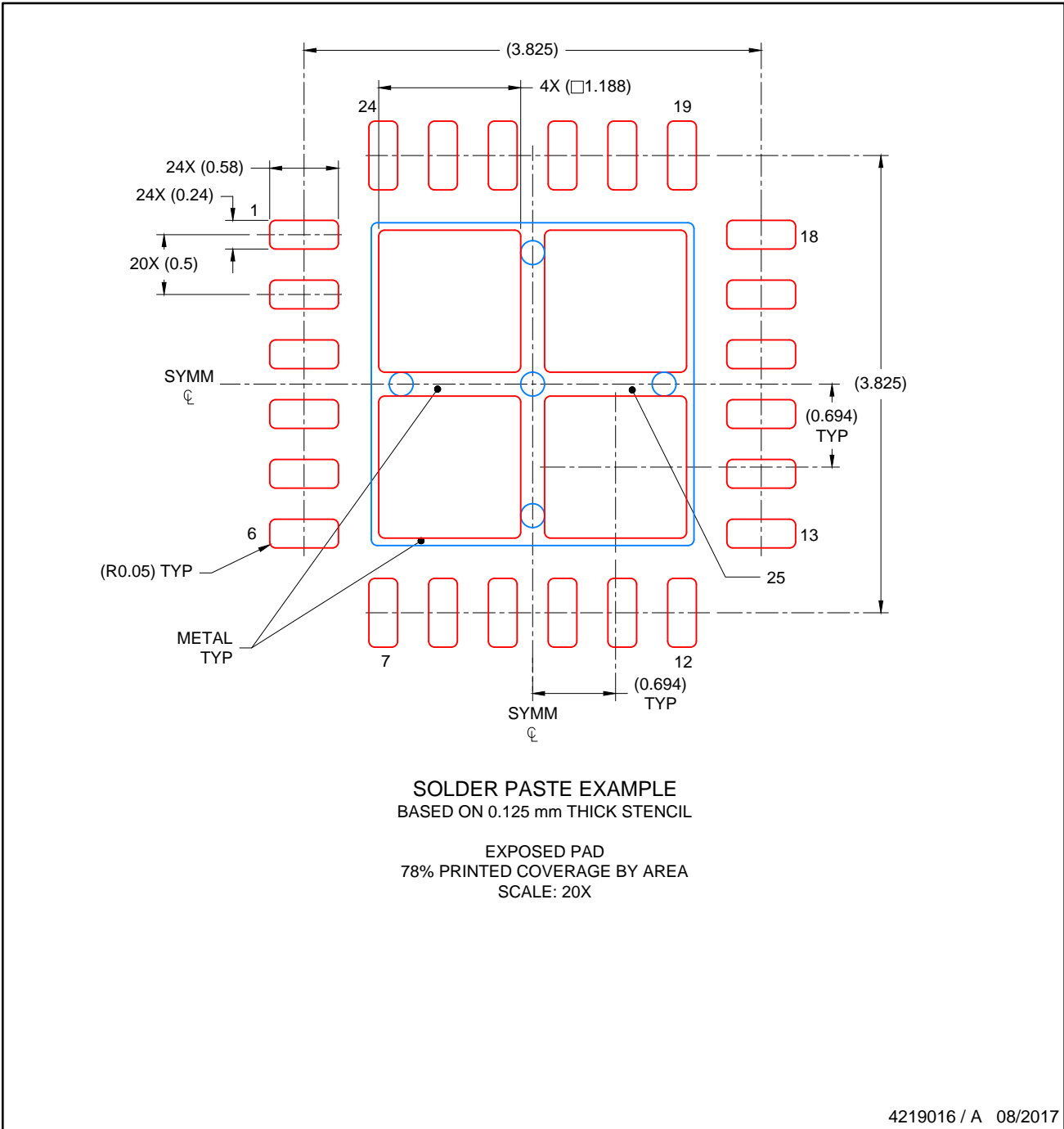

NOTES: (continued)

6. Laser cutting apertures with trapezoidal walls and rounded corners may offer better paste release. IPC-7525 may have alternate design recommendations..

IMPORTANT NOTICE AND DISCLAIMER

TI PROVIDES TECHNICAL AND RELIABILITY DATA (INCLUDING DATASHEETS), DESIGN RESOURCES (INCLUDING REFERENCE DESIGNS), APPLICATION OR OTHER DESIGN ADVICE, WEB TOOLS, SAFETY INFORMATION, AND OTHER RESOURCES "AS IS" AND WITH ALL FAULTS, AND DISCLAIMS ALL WARRANTIES, EXPRESS AND IMPLIED, INCLUDING WITHOUT LIMITATION ANY IMPLIED WARRANTIES OF MERCHANTABILITY, FITNESS FOR A PARTICULAR PURPOSE OR NON-INFRINGEMENT OF THIRD PARTY INTELLECTUAL PROPERTY RIGHTS.

These resources are intended for skilled developers designing with TI products. You are solely responsible for (1) selecting the appropriate TI products for your application, (2) designing, validating and testing your application, and (3) ensuring your application meets applicable standards, and any other safety, security, or other requirements. These resources are subject to change without notice. TI grants you permission to use these resources only for development of an application that uses the TI products described in the resource. Other reproduction and display of these resources is prohibited. No license is granted to any other TI intellectual property right or to any third party intellectual property right. TI disclaims responsibility for, and you will fully indemnify TI and its representatives against, any claims, damages, costs, losses, and liabilities arising out of your use of these resources.

TI's products are provided subject to TI's Terms of Sale (www.ti.com/legal/termsofsale.html) or other applicable terms available either on ti.com or provided in conjunction with such TI products. TI's provision of these resources does not expand or otherwise alter TI's applicable warranties or warranty disclaimers for TI products.

Mailing Address: Texas Instruments, Post Office Box 655303, Dallas, Texas 75265
Copyright © 2019, Texas Instruments Incorporated