

# BQ25150 500-mA Linear charger with 10-nA ship mode, advanced power path management and control, ADC, and LDO

## 1 Features

- Linear battery charger with 1.25-mA to 500-mA fast charge current range
  - 0.5% Accurate I<sup>2</sup>C programmable battery regulation voltage ranging from 3.6 V to 4.6 V in 10-mV steps
  - Configurable termination current supporting down to 0.5 mA
  - 20-V Tolerant input with typical 3.4-V to 5.5-V input voltage operating range
  - Programmable thermal charging profile, fully configurable hot, warm, cool and cold thresholds
- Power path management for powering system and charging battery
  - Dynamic power path management optimizes charging from weak adapters
  - Advanced I<sup>2</sup>C control allows host to disconnect the battery or adapter as needed
- I<sup>2</sup>C Configurable load switch or up to 150-mA LDO output
  - Programmable range from 0.6 V to 3.7 V in 100-mV steps
- Ultra low I<sub>ddq</sub> for extended battery life
  - 10-nA Ship mode battery I<sub>q</sub>
  - 400-nA I<sub>q</sub> While powering the system (PMID and VDD on)
- One push-button wake-up and reset input with adjustable timers
  - Supports system power cycle and HW reset
- 12-Bit effective ADC
  - Monitoring of charge current, battery thermistor and battery, input and system (PMID) voltages
  - General purpose ADC input
- Always on 1.8-V VDD LDO supporting loads up to 10 mA
- 20-Pin 2-mm x 1.6-mm CSP package
- 12-mm<sup>2</sup> Total solution size

## 2 Applications

- Headsets, earbuds and hearing aids
- Smart watches and fitness accessories
- Patient monitors and portable medical equipment

## 3 Description

The BQ25150 is a highly integrated battery charge management IC that integrates the most common functions for wearable devices, namely a charger, an output voltage rail, ADC for battery and system monitoring, and push-button controller.

### Device Information<sup>(1)</sup>

PART NUMBER	PACKAGE	BODY SIZE (NOM)
BQ25150	DSBGA (20)	2.00 mm x 1.60 mm

(1) For all available packages, see the orderable addendum at the end of the data sheet.

### Simplified Schematic

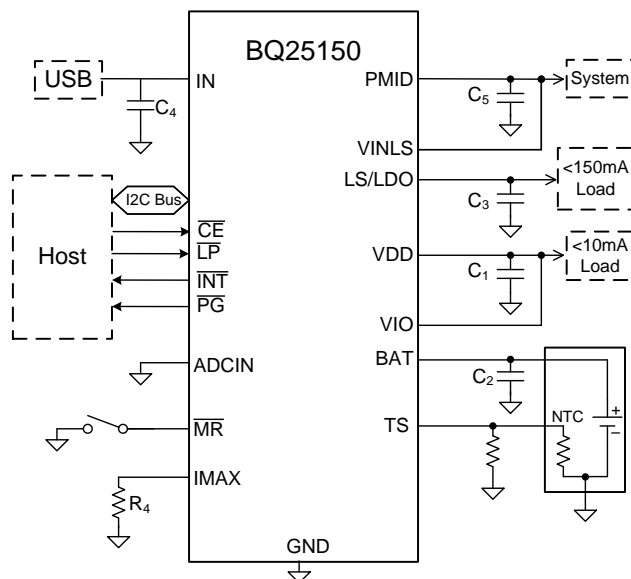

### Solution Area

12 mm<sup>2</sup> Solution Size

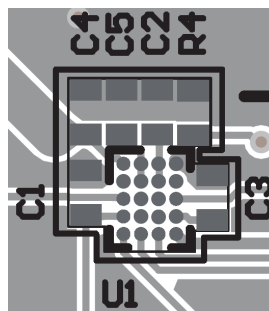

- 0402 Component footprint with 0.2mm pitch
- Pull up and TS resistors not included



## Table of Contents

<b>1 Features</b> .....	<b>1</b>	8.4 Device Functional Modes .....	<b>33</b>
<b>2 Applications</b> .....	<b>1</b>	8.5 Register Map .....	<b>37</b>
<b>3 Description</b> .....	<b>1</b>	<b>9 Application and Implementation</b> .....	<b>92</b>
<b>4 Revision History</b> .....	<b>2</b>	9.1 Application Information .....	<b>92</b>
<b>5 Description (continued)</b> .....	<b>3</b>	9.2 Typical Application .....	<b>92</b>
<b>6 Pin Configuration and Functions</b> .....	<b>4</b>	<b>10 Power Supply Recommendations</b> .....	<b>98</b>
<b>7 Specifications</b> .....	<b>5</b>	<b>11 Layout</b> .....	<b>99</b>
7.1 Absolute Maximum Ratings .....	<b>5</b>	11.1 Layout Guidelines .....	<b>99</b>
7.2 ESD Ratings .....	<b>5</b>	11.2 Layout Example .....	<b>99</b>
7.3 Recommended Operating Conditions .....	<b>6</b>	<b>12 Device and Documentation Support</b> .....	<b>100</b>
7.4 Thermal Information .....	<b>6</b>	12.1 Documentation Support .....	<b>100</b>
7.5 Electrical Characteristics .....	<b>6</b>	12.2 Receiving Notification of Documentation Updates .....	<b>100</b>
7.6 Timing Requirements .....	<b>9</b>	12.3 Community Resources .....	<b>100</b>
7.7 Typical Characteristics .....	<b>11</b>	12.4 Trademarks .....	<b>100</b>
<b>8 Detailed Description</b> .....	<b>13</b>	12.5 Electrostatic Discharge Caution .....	<b>100</b>
8.1 Overview .....	<b>13</b>	12.6 Glossary .....	<b>100</b>
8.2 Functional Block Diagram .....	<b>13</b>	<b>13 Mechanical, Packaging, and Orderable Information</b> .....	<b>100</b>
8.3 Feature Description .....	<b>14</b>		

## 4 Revision History

NOTE: Page numbers for previous revisions may differ from page numbers in the current version.

<b>Changes from Revision A (October 2018) to Revision B</b>	<b>Page</b>
• Deleted 12-Bit from title .....	<b>1</b>
• Changed from Restricted to Public .....	<b>1</b>
• Changed ADC reported resolution TYP value from 12 to 16 .....	<b>8</b>
• Changed T <sub>SHUTDOWN</sub> TYP value from 115°C to 125°C .....	<b>9</b>
• Changed PUSHBUTTON TIMERS (/MR) number of decimal points in MIN/MAX from 3 to 2 .....	<b>9</b>
• Deleted t <sub>DGL_SC</sub> parameter .....	<b>10</b>
• Deleted t <sub>LP_ENTRY</sub> parameter .....	<b>10</b>
• Changed default state description for watchdog in <a href="#">Safety Timer and I<sup>2</sup>C Watchdog Timer</a> .....	<b>18</b>
• Deleted 12-Bit from <a href="#">ADC</a> .....	<b>20</b>
• Changed LS/LDO1 to V <sub>LSLDO</sub> in <a href="#">Load Switch / LDO Output and Control</a> .....	<b>21</b>
• Added Section <a href="#">14-second Watchdog for HW Reset</a> .....	<b>26</b>
• Changed THERM_REG_2:0 reset value in <a href="#">CHARGERCTRL1 Register (Address = 0x18) [reset = 0x42]</a> section .....	<b>56</b>
• Changed 1_ADCALARM_ABOVE in <a href="#">Table 51</a> .....	<b>80</b>
• Changed 2_ADCALARM_ABOVE in <a href="#">Table 53</a> .....	<b>82</b>
• Changed 3_ADCALARM_ABOVE in <a href="#">Table 55</a> .....	<b>84</b>

<b>Changes from Original (July 2018) to Revision A</b>	<b>Page</b>
• Changed from Advance Information to Production Data .....	<b>1</b>

## 5 Description (continued)

The BQ25150 IC integrates a linear charger that enables quick and accurate charging for small batteries. The device supports charge current up to 500mA and supports termination current down to 0.5mA for maximum charge. The battery is charged using a standard Li-Ion charge profile with three phases: pre-charge, constant current and constant voltage regulation.

The device integrates advanced power path management and control that allows the device to provide power to the system while charging the battery even with poor adapters. The host may also control the power path through I<sup>2</sup>C allowing it to disconnect the input adapter and/or battery without physically removing them. The single push-button input eliminates the need of a separate button controller IC reducing the total solution footprint. The push-button input can be used for wake functions or to reset the system. A 12-bit effective ADC enables accurate battery voltage monitoring and can be used to enable a low I<sub>q</sub> gauging to monitor battery health. It can also be used to measure the battery temperature using a thermistor connected to the TS pin as well as external system signals through a pin. The low quiescent current during operation and shutdown enables maximum battery life. The input current limit, charge current, LDO output voltage, and other parameters are programmable through the I<sup>2</sup>C interface making the BQ25150 a very flexible charging solution. A voltage-based JEITA compatible (or standard HOT/COLD) battery pack thermistor monitoring input (TS) is included that monitors battery temperature and automatically changes charge parameters to prevent the battery from charging outside of its safe temperature range. The temperature thresholds are also programable through I<sup>2</sup>C allowing the host to customize the thermal charging profile. The charger is optimized for 5V USB input, with 20V absolute maximum tolerance to withstand line transients. The device also integrates a linear regulator to provide a quiet rail for radios or processors and can be independently sourced and controlled through I<sup>2</sup>C.

## 6 Pin Configuration and Functions

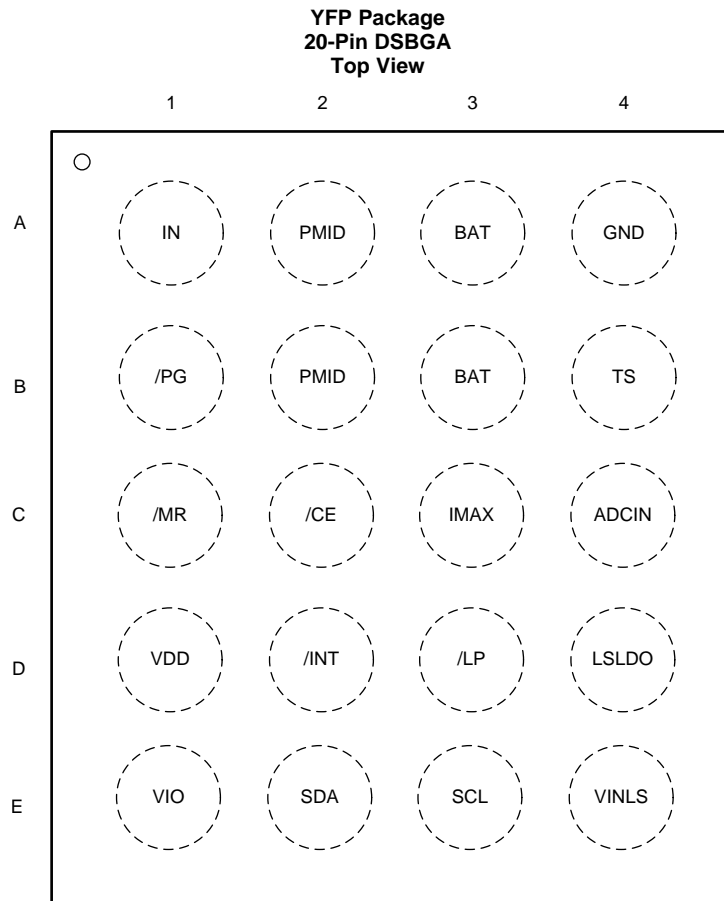

### Pin Functions

PIN		I/O	DESCRIPTION
NAME	NO.		
IN	A1	I	DC Input Power Supply. IN is connected to the external DC supply. Bypass IN to GND with at least 1 uF of capacitance using a ceramic capacitor.
PMID	A2, B2	I/O	High Side Bypass Connection. Connect at least 10 uF ceramic capacitor (at least 3 uF of ceramic capacitance with DC bias de-rating) from PMID to GND as close to the PMID and GND pins as possible. Note: Shorting PMID to IN pin is not recommended as it may cause large discharge current from battery to IN if IN pin is not truly floating.
GND	A4	PWR	Ground connection. Connect to the ground plane of the circuit.
VDD	D1	O	Digital supply LDO. Connect at least 4.7 uF capacitor to ground.
$\overline{\text{CE}}$	C2	I	Charge Enable. Drive $\overline{\text{CE}}$ low or leave disconnected to enable charging when VIN is valid. Drive $\overline{\text{CE}}$ high to disable charge when VIN is present. $\overline{\text{CE}}$ is pulled low internally with 900-k $\Omega$ resistor. $\overline{\text{CE}}$ has no effect when VIN is not present.
SCL	E3	I/O	I <sup>2</sup> C Interface Clock. Connect SCL to the logic rail through a 10-k $\Omega$ resistor.
SDA	E2	I	I <sup>2</sup> C Interface Data. Connect SDA to the logic rail through a 10-k $\Omega$ resistor.
$\overline{\text{LP}}$	D3	I	Low Power Mode Enable. Drive this pin low to enable the device in low power mode when powered by the battery. $\overline{\text{LP}}$ is pulled low internally with 900 kOhm resistor. This pin has no effect when VIN is present.
IMAX	C3	I	Connect a 10-kOhms or lower resistor to this pin to set the maximum allowable fast charge current. Must not be left floating.
$\overline{\text{INT}}$	D2	O	$\overline{\text{INT}}$ is an open-drain output that signals fault interrupts. When a fault occurs, a 128us pulse is sent out as an interrupt for the host. $\overline{\text{INT}}$ is enabled/disabled using the MASK_INT bit in the control register.

### Pin Functions (continued)

PIN		I/O	DESCRIPTION
NAME	NO.		
ADCIN	C4	I	Input Channel to the ADC. Maximum ADC range 1.2 V.
$\overline{\text{MR}}$	C1	I	Manual Reset Input. $\overline{\text{MR}}$ is a general purpose input that must be held low for greater than $t_{\text{HWRESET}}$ to go into HW Reset and power cycle the output rails. If $\overline{\text{MR}}$ is also used to wake up the device out of Ship Mode when pressed for at least $t_{\text{WAKE2}}$ . $\overline{\text{MR}}$ has an internal 125-k $\Omega$ pull-up resistor to BAT.
LS/LDO	D4	O	Load Switch or LDO output. Connect 2.2 $\mu\text{F}$ of ceramic capacitance to this pin to assure stability. Be sure to account for capacitance bias voltage derating when selecting the capacitor.
VINLS	E4	I	Input to the Load Switch / LDO output. Connect at least 1 $\mu\text{F}$ of ceramic capacitance from this pin to ground.
BAT	A3, B3	I/O	Battery Connection. Connect to the positive terminal of the battery. Bypass BAT to GND with at least 1 $\mu\text{F}$ of ceramic capacitance.
TS	B4	I	Battery Pack NTC Monitor. Connect TS to a 10k $\Omega$ NTC Thermistor in parallel to a 10-k $\Omega$ resistor. If TS function is not to be used connect a 5-k $\Omega$ resistor from TS to ground.
$\overline{\text{PG}}$	B1	O	Open-drain Power Good status indication output. $\overline{\text{PG}}$ is pulled to GND when VIN is above $V_{\text{BAT}} + V_{\text{SLP}}$ and less than $V_{\text{OVP}}$ . $\overline{\text{PG}}$ is high-impedance when the input power is not within specified limits. Connect $\overline{\text{PG}}$ to the desired logic voltage rail using a 1-k $\Omega$ to 100-k $\Omega$ resistor, or use with an LED for visual indication. $\overline{\text{PG}}$ can also be configured through I <sup>2</sup> C as a push-button level shifted output ( $\overline{\text{MR}}$ ), where the output of the $\overline{\text{PG}}$ pin reflects the status of the $\overline{\text{MR}}$ input, but pulled up to the desired logic voltage rail using a 1-k $\Omega$ to 100-k $\Omega$ resistor. The $\overline{\text{PG}}$ pin can also be configured as a general purpose open drain output.
VIO	E1	I	System IO supply. Connect to system IO supply to allow level shifting of input signals (SDA, SCL, LP and CE) to the device internal digital domain. Connect to VDD when external IO supply is not available.

## 7 Specifications

### 7.1 Absolute Maximum Ratings

over operating free-air temperature range (unless otherwise noted)<sup>(1)</sup>

		MIN	MAX	UNIT
Voltage	IN	-0.3	20	V
	TS, ADCIN, IMAX, VDD	-0.3	1.95	V
	All other pins	-0.3	5.5	V
Current	IN	0	800	mA
	BAT, PMID	-0.5	1.5	A
	INT, ADCIN, PG	0	10	mA
Junction temperature, $T_{\text{J}}$		-40	125	°C
Storage temperature, $T_{\text{stg}}$		-55	150	°C

- (1) Stresses beyond those listed under *Absolute Maximum Rating* may cause permanent damage to the device. These are stress ratings only, which do not imply functional operation of the device at these or any other conditions beyond those indicated under *Recommended Operating Condition*. Exposure to absolute-maximum-rated conditions for extended periods may affect device reliability.

### 7.2 ESD Ratings

		VALUE	UNIT
$V_{\text{(ESD)}}$	Electrostatic discharge	Human body model (HBM), per ANSI/ESDA/JEDEC JS-001, all pins <sup>(1)</sup>	±2000
		Charged device model (CDM), per JEDEC specification JESD22-C101, all pins <sup>(2)</sup>	±500

- (1) JEDEC document JEP155 states that 500-V HBM allows safe manufacturing with a standard ESD control process.

- (2) JEDEC document JEP157 states that 250-V CDM allows safe manufacturing with a standard ESD control process.

### 7.3 Recommended Operating Conditions

over operating free-air temperature range (unless otherwise noted)

		MIN	NOM	MAX	UNIT
V <sub>BAT</sub>	Battery voltage range	2.4		4.6	V
V <sub>IN</sub>	Input voltage range	3.15		5.25 <sup>(1)</sup>	V
V <sub>INLS</sub>	LDO input voltage range	2.2		5.25 <sup>(1)</sup>	V
V <sub>IO</sub>	IO supply voltage range	1.2		3.6	V
V <sub>ADCIN</sub>	ADC input voltage range	0		1.2	V
I <sub>LDO</sub>	LDO output current	0		100	mA
I <sub>PMID</sub>	PMID output current	0		500	mA
T <sub>A</sub>	Operating free-air temperature range	-40		85	°C

 (1) Based on minimum V<sub>OVP</sub> value. 5.5V under typical conditions

### 7.4 Thermal Information

THERMAL METRIC <sup>(1)</sup>		DEVICE		UNIT
		YFP (DSBGA)		
		20-PIN		
R <sub>θJA</sub>	Junction-to-ambient thermal resistance <sup>(2)</sup>	36.1		°C/W
R <sub>θJA</sub>	Junction-to-ambient thermal resistance	74.4		°C/W
R <sub>θJC(top)</sub>	Junction-to-case (top) thermal resistance	0.5		°C/W
R <sub>θJB</sub>	Junction-to-board thermal resistance	17.6		°C/W
Ψ <sub>JT</sub>	Junction-to-top characterization parameter	0.3		°C/W
Ψ <sub>JB</sub>	Junction-to-board characterization parameter	17.7		°C/W
R <sub>θJC(bot)</sub>	Junction-to-case (bottom) thermal resistance	N/A		°C/W

 (1) For more information about traditional and new thermal metrics, see the [Semiconductor and IC Package Thermal Metrics](#) application report.

(2) Measured in BQ25150EVM board

### 7.5 Electrical Characteristics

 V<sub>IN</sub> = 5V, V<sub>BAT</sub> = 3.6V. -40°C < T<sub>J</sub> < 125°C unless otherwise noted. Typical data at T<sub>J</sub> = 25°C

PARAMETER	TEST CONDITIONS	MIN	TYP	MAX	UNIT	
<b>INPUT CURRENTS</b>						
I <sub>IN</sub>	Input supply current	PMID_MODE= 01, V <sub>IN</sub> = 5V, V <sub>BAT</sub> = 3.6V		500	μA	
		0°C < T <sub>J</sub> < 85°C, V <sub>IN</sub> = 5V, V <sub>BAT</sub> = 3.6V Charge Disabled		0.78	1.5	mA
I <sub>BAT_SHIP</sub>	Battery Discharge Current in Ship Mode	0°C < T <sub>J</sub> < 60°C, V <sub>IN</sub> = 0V, V <sub>BAT</sub> = 3.6V		10	150	nA
I <sub>BAT_LP</sub>	Battery Quiescent Current in Low-power Mode	0°C < T <sub>J</sub> < 60°C, V <sub>IN</sub> = 0V, V <sub>BAT</sub> = 3.6V, LDO Disabled		0.46	1.2	μA
		0°C < T <sub>J</sub> < 60°C, V <sub>IN</sub> = 0V, V <sub>BAT</sub> = 3.6V, LDO Enabled		1.7	3.5	μA
I <sub>BAT_ACTI</sub> V <sub>E</sub>	Battery Quiescent Current in Active Mode	0°C < T <sub>J</sub> < 85°C, V <sub>IN</sub> = 0V, V <sub>BAT</sub> = 3.6V, LDO Disabled		18	25	μA
		0°C < T <sub>J</sub> < 85°C, V <sub>IN</sub> = 0V, V <sub>BAT</sub> = 3.6V, LDO Enabled		21	27	μA
<b>POWER PATH MANAGEMENT AND INPUT CURRENT LIMIT</b>						
R <sub>ON(IN-PMID)</sub>	Input FET ON resistance	I <sub>LIM</sub> = 500mA (I <sub>LIM</sub> = 110), V <sub>IN</sub> = 5V, I <sub>IN</sub> = 150mA		280	520	mΩ
V <sub>BSUP1</sub>	Enter supplements mode threshold	V <sub>BAT</sub> > V <sub>BATUVLO</sub> ,		V <sub>PMID</sub> < V <sub>BAT</sub> - 40mV		mV

## Electrical Characteristics (continued)

$V_{IN} = 5V$ ,  $V_{BAT} = 3.6V$ .  $-40^{\circ}C < T_J < 125^{\circ}C$  unless otherwise noted. Typical data at  $T_J = 25^{\circ}C$

PARAMETER		TEST CONDITIONS	MIN	TYP	MAX	UNIT
$V_{BSUP2}$	Exit supplements mode threshold	$V_{BAT} > V_{BATUVLO}$		$V_{PMID} < V_{BAT} - 20mV$		mV
$I_{ILIM}$	Input Current Limit	Programmable Range	50		600	mA
		$I_{ILIM} = 50mA$		45	50	mA
		$I_{ILIM} = 100mA$		90	100	mA
		$I_{ILIM} = 150mA$		135	150	mA
		$I_{ILIM} = 500mA$		450	500	mA
$V_{IN\_DPM}$	Input DPM voltage threshold where current in reduced	Programmable Range	4.2		4.9	V
	Accuracy		-3		3	%
<b>BATTERY CHARGER</b>						
$V_{DPPM}$	PMID voltage threshold when charge current is reduced	$V_{PMID} - V_{BAT}$		200		mV
$R_{ON(BAT-PMID)}$	Battery Discharge FET On Resistance	$V_{BAT} = 4.35V$ , $I_{BAT} = 100mA$		100	175	m $\Omega$
$V_{BATREG}$	Charge Voltage	Programmable charge voltage range	3.6		4.6	V
	Voltage Regulation Accuracy	$T_J = 25^{\circ}C$	0.5		0.5	%
$I_{CHARGE}$	Fast Charge Programmable Current Range	$V_{LOWV} < V_{BAT} < V_{BATREG}$	1.25		500	mA
	Fast Charge Current Accuracy	$T_J = 25^{\circ}C$ , $I_{CHARGE} > 5mA$	-5		5	%
$I_{PRECHARGE}$	Precharge current	Precharge current programmable range	1.25		77.5	mA
	Precharge Current Accuracy	$-40^{\circ}C < T_J < 85^{\circ}C$	-10		10	%
$I_{TERM}$	Termination Charge Current	Termination Current Programmable Range	1		31	%
	Accuracy	$T_J = 25^{\circ}C$ , $I_{TERM} = 10\% I_{CHARGE}$ , $I_{CHARGE} = 100mA$	-5 <sup>(1)</sup>		5 <sup>(1)</sup>	%
		$-10^{\circ}C < T_J < 85^{\circ}C$ , $I_{TERM} = 10\% I_{CHARGE}$ , $I_{CHARGE} = 100mA$	-10 <sup>(1)</sup>		10 <sup>(1)</sup>	%
$V_{LOWV}$	Programmable voltage threshold for pre-charge to fast charge transitions	$V_{BAT}$ rising. Programmable Range	2.8		3	V
$V_{SHORT}$	Battery voltage threshold for short detection	$V_{BAT}$ falling, $V_{IN} = 5V$	2.41	2.54	2.67	V
$I_{SHORT}$	Charge Current in Battery Short Condition	$V_{BAT} < V_{SHORT}$		$I_{PRECHARGE}$		mA
$V_{RCH}$	Recharge Threshold voltage	$V_{BAT}$ falling, $V_{BATREG} = 4.2V$ , $V_{RCH} = 140mV$ setting		140		mV
		$V_{BAT}$ falling, $V_{BATREG} = 4.2V$ , $V_{RCH} = 200mV$ setting		200		mV
$R_{PMID\_PD}$	PMID pull-down resistance	$V_{PMID} = 3.6V$		25		$\Omega$
<b>VDD</b>						
$V_{DD}$	VDD LDO output voltage	$V_{BAT} = 3.6V$ , $V_{IN} = 0V$ , $0 < I_{LOAD\_VDD} < 10mA$		1.8		V
$I_{LOAD\_VDD}$	Maximum VDD External load capability	$V_{PMID} > 3V$			10	mA
<b>LS/LDO</b>						
$V_{INLS}$	Input voltage range for Load switch Mode		0.8		5.5	V
	Input voltage range for LDO Mode		2.2 or $V_{LDO} + 500mV$		5.5	V

(1) Based on Characterization Data

**Electrical Characteristics (continued)**
 $V_{IN} = 5V$ ,  $V_{BAT} = 3.6V$ .  $-40^{\circ}C < T_J < 125^{\circ}C$  unless otherwise noted. Typical data at  $T_J = 25^{\circ}C$ 

PARAMETER		TEST CONDITIONS	MIN	TYP	MAX	UNIT
$V_{LDO}$	LDO programmable output voltage range		0.6		3.7	V
	LDO output accuracy	$T_J = 25^{\circ}C$ $V_{LDO} = 1.8V$ , $V_{INLS} = 3.6V$ , $I_{LOAD} = 1mA$	-2		2	%
$\Delta V_{OUT}/\Delta I_{OUT}$	DC Load Regulation	$0^{\circ}C < T_J < 85^{\circ}C$ , $1mA < I_{OUT} < 150mA$ , $V_{LDO} = 1.8V$		1.2		%
$\Delta V_{OUT}/\Delta V_{IN}$	DC Line Regulation	$0^{\circ}C < T_J < 85^{\circ}C$ , Over $V_{INLS}$ range, $I_{OUT} = 100mA$ , $V_{LDO} = 1.8V$		0.5		%
$R_{DOSN\_LDO}$	Switch On resistance	$V_{INLS} = 3.6V$		250	450	m $\Omega$
$R_{DSCH\_LSLDO}$	Discharge FET On-resistance for LS	$V_{INLS} = 3.6V$		40		$\Omega$
$I_{OCL\_LDO}$	Output Current Limit	$V_{LS/LDO} = 0V$	200	300		mA
$I_{IN\_LDO}$	LDO VINLS quiescent current in LDO mode	$V_{BAT} = V_{INLS} = 3.6V$		0.9		$\mu A$
	OFF State Supply Current	$V_{BAT} = V_{INLS} = 3.6V$		0.25		$\mu A$
<b>ADC</b>						
Resolution	Bits reported by ADC			16		Bits
$t_{ADC\_CONV}$	Conversion-time	ADC_SPEED = 00		24		ms
		ADC_SPEED = 01		12		ms
		ADC_SPEED = 10		6		ms
		ADC_SPEED = 11		3		ms
Resolution	Effective Resolution	ADC_SPEED = 00		12		Bits
		ADC_SPEED = 10		10		Bits
Accuracy	ADC TS Accuracy	ADC_SPEED = 00, $V_{TS} = 0.4V$ , $-10^{\circ}C < T_J < 85^{\circ}C$	-1 <sup>(1)</sup>		1 <sup>(1)</sup>	%
	ADC ADCIN Accuracy	ADC_SPEED = 00, $V_{ADCIN} = 0.4V$ , $-10^{\circ}C < T_J < 85^{\circ}C$	-1 <sup>(1)</sup>		1 <sup>(1)</sup>	%
	ADC VBAT Accuracy	ADC_SPEED = 00, $V_{BAT} = 4.2V$ , $-10^{\circ}C < T_J < 85^{\circ}C$	-0.4		0.4	%
<b>BATTERY PACK NTC MONITOR</b>						
$V_{HOT}$	High temperature threshold	$V_{TS}$ falling, $-10^{\circ}C < T_J < 85^{\circ}C$	0.182 <sup>(1)</sup>	0.185	0.189 <sup>(1)</sup>	V
$V_{WARM}$	Warm temperature threshold	$V_{TS}$ falling, $-10^{\circ}C < T_J < 85^{\circ}C$	0.262 <sup>(1)</sup>	0.265	0.268 <sup>(1)</sup>	V
$V_{COOL}$	Cool temperature threshold	$V_{TS}$ rising, $-10^{\circ}C < T_J < 85^{\circ}C$	0.510 <sup>(1)</sup>	0.514	0.518 <sup>(1)</sup>	V
$V_{COLD}$	Cold temperature threshold	$V_{TS}$ rising, $-10^{\circ}C < T_J < 85^{\circ}C$	0.581 <sup>(1)</sup>	0.585	0.589 <sup>(1)</sup>	V
$V_{OPEN}$	TS Open threshold	$V_{TS}$ rising, $-10^{\circ}C < T_J < 85^{\circ}C$		0.9		V
$V_{HYS}$	Threshold hysteresis			4.7		mV
$I_{TS\_BIAS}$	TS bias current	$-10^{\circ}C < T_J < 85^{\circ}C$	78.4	80	81.6	$\mu A$
<b>PROTECTION</b>						
$V_{UVLO}$	IN active threshold voltage	$V_{IN}$ rising		3.4		V
		$V_{IN}$ falling		3.25		V
$V_{BATUVLO}$	Battery undervoltage Lockout Threshold Voltage	Programmable range, 150 mV Hysteresis	2.4		3	V
	Accuracy		-3		3	%
	Battery undervoltage Lockout Threshold Voltage at Power Up	$V_{BAT}$ rising, $V_{IN} = 0V$ , $T_J = 25^{\circ}C$		3.15		V
$V_{SLP\_ENTRY}$	Sleep Entry Threshold ( $V_{IN} - V_{BAT}$ )	$2.0V < V_{BAT} < V_{BATREG}$ , $V_{IN}$ falling		80		mV



## Electrical Characteristics (continued)

 $V_{IN} = 5V$ ,  $V_{BAT} = 3.6V$ .  $-40^{\circ}C < T_J < 125^{\circ}C$  unless otherwise noted. Typical data at  $T_J = 25^{\circ}C$ 

PARAMETER		TEST CONDITIONS	MIN	TYP	MAX	UNIT
$V_{SLP\_EXIT}$	Sleep Exit Threshold ( $V_{IN} - V_{BAT}$ )	$2.0V < V_{BAT} < V_{BATREG}$		130		mV
$V_{OVP}$	Input Supply Over Voltage Threshold	$V_{IN}$ rising	5.35	5.5	5.8	V
		$V_{IN}$ falling (125mV hysteresis)		5.4		V
$I_{BAT\_OCP}$	Battery Over Current Threshold Programmable range	$I_{BAT\_OCP}$ increasing	1200		1600	mA
	Current Limit Accuracy		-30		30	%
$T_{SHUTDO\_WN}$	Thermal shutdown trip point			125		$^{\circ}C$
$T_{HYS}$	Thermal shutdown trip point hysteresis			15		$^{\circ}C$
<b>I<sup>2</sup>C INTERFACE (SCL and SDA)</b>						
$I_2C$ Frequency			100		400	kHz
$V_{IL}$	Input Low threshold level	$V_{PULLUP} = V_{IO} = 1.8V$			$0.25 * V_{IO}$	V
$V_{IH}$	Input High Threshold level	$V_{PULLUP} = V_{IO} = 1.8V$	$0.75 * V_{IO}$			V
$V_{OL}$	Output Low threshold level	$V_{PULLUP} = V_{IO} = 1.8V$ , $I_{LOAD} = 5mA$			$0.25 * V_{IO}$	V
$I_{LKG}$	High-level leakage Current	$V_{PULLUP} = V_{IO} = 1.8V$			1	$\mu A$
<b>/MR INPUT</b>						
$R_{PU}$	Internal pull up resistance		90	125	170	k $\Omega$
$V_{IL}$	/MR Input Low threshold level	$V_{BAT} > V_{BUVLO}$			0.3	V
<b>/INT, /PG OUTPUTS</b>						
$V_{OL}$	Output Low threshold level	$V_{PULLUP} = V_{IO} = 1.8V$ , $I_{LOAD} = 5mA$			$0.25 * V_{IO}$	V
$I_{LKG}$	/INT Hi level leakage Current	High Impedance, $V_{PULLUP} = V_{IO} = 1.8V$			1	$\mu A$
<b>/CE, /LP INPUTS</b>						
$R_{PDOWN}$	/CE pull down resistance			900		k $\Omega$
$V_{IL}$	Input Low threshold level	$V_{IO} = 1.8V$			0.45	V
$V_{IH}$	/CE Input High Threshold level	$V_{IO} = 1.8V$	1.35			V

## 7.6 Timing Requirements

PARAMETER		TEST CONDITIONS	MIN	TYP	MAX	UNIT
<b>BATTERY CHARGE TIMERS</b>						
$t_{MAXCHG}$	Charge safety timer	Programmable range	180		720	min
$t_{PRECHG}$	Precharge safety timer			$0.25 * t_{MAXCHG}$		
<b>WATCHDOG TIMERS</b>						
$t_{WATCHDOG\_SW}$	SW Watchdog timer		25	50		s
$t_{HW\_RESET\_WD}$	HW reset watchdog timer	WATCHDOG_15S_ENABLE = 1			15	s
<b>LDO</b>						
$t_{ON\_LDO}$	Turn ON time	100mA load, to 90% $V_{LDO}$		500		$\mu s$
$t_{OFF\_LDO}$	Turn OFF time	100mA load, to 10% $V_{LDO}$		30		$\mu s$
$t_{PMID\_LDO\_DELAY}$	Delay between PMID and LDO enable during power up	Startup		20		ms
<b>PUSHBUTTON TIMERS (MR)</b>						

**Timing Requirements (continued)**

PARAMETER		TEST CONDITIONS	MIN	TYP	MAX	UNIT
t <sub>WAKE1</sub>	WAKE1 Timer. Time from /MR falling edge to INT being asserted.	MR_WAKE1_TIMER = 0	106	125	144	ms
		MR_WAKE1_TIMER = 1	425	500	575	ms
t <sub>WAKE2</sub>	WAKE2 Timer. Time from /MR falling edge to INT being asserted.	MR_WAKE2_TIMER = 0	0.85	1	1.15	s
		MR_WAKE2_TIMER = 1	1.7	2	2.3	s
t <sub>RESET_WARN</sub>	RESET_WARN Timer. Time prior to HW RESET	MR_RESET_WARN = 00	0.42	0.5	0.58	s
		MR_RESET_WARN = 01	0.85	1	1.15	s
		MR_RESET_WARN = 10	1.27	1.5	1.73	s
		MR_RESET_WARN = 11	1.7	2	2.3	s
t <sub>HW_RESET</sub>	HW RESET Timer. Time from /MR falling edge to HW Reset	MR_HW_RESET = 00	3.4	4	4.6	s
		MR_HW_RESET = 01	6.8	8	9.2	s
		MR_HW_RESET = 10	8.5	10	11.5	s
		MR_HW_RESET = 11	11.9	14	16.1	s
t <sub>RESTART(AUTOWAKE)</sub>	RESTART Timer. Time from /MR HW Reset to PMID power up	AUTOWAKE = 00	0.52	0.6	0.68	s
		AUTOWAKE = 01	1.05	1.2	1.35	s
		AUTOWAKE = 10	2.11	2.4	2.69	s
		AUTOWAKE = 11	4.4	5	5.6	s
<b>PROTECTION</b>						
t <sub>DGL_SLP</sub>	Deglitch time for supply rising above V <sub>SLP</sub> + V <sub>SLP_HYS</sub>			120		μs
t <sub>DGL_OVP</sub>	Deglitch time for V <sub>OVP</sub> Threshold	VIN falling below V <sub>OVP</sub>		32		ms
t <sub>DGL_OCP</sub>	Battery OCP deglitch time			30		μs
t <sub>REC_SC</sub>	Recovery time, BAT Short Circuit during Discharge Mode			250		ms
t <sub>RETRY_SC</sub>	Retry window for PMID or BAT short circuit recovery			2		s
t <sub>DGL_SHTDWN</sub>	Deglitch time, Thermal shutdown	T <sub>J</sub> rising above T <sub>SHUTDOWN</sub>		10		μs
<b>I2C INTERFACE</b>						
t <sub>WATCHDOG</sub>	I2C interface reset timer for host	When enabled		50		s
t <sub>I2CRESET</sub>	I2C interface inactive reset timer			500		ms
<b>INPUT PINS (/CE and /LP)</b>						
t <sub>LP_EXIT_I2C</sub>	Time for device to exit Low-power mode and allow I <sup>2</sup> C communication	V <sub>IN</sub> = 0V.			1	ms

### 7.7 Typical Characteristics

$C_{IN} = 1\mu F$ ,  $C_{PMID} = 10\mu F$ ,  $C_{LSLDO} = 2.2\mu F$ ,  $C_{BAT} = 1\mu F$  (unless otherwise specified)

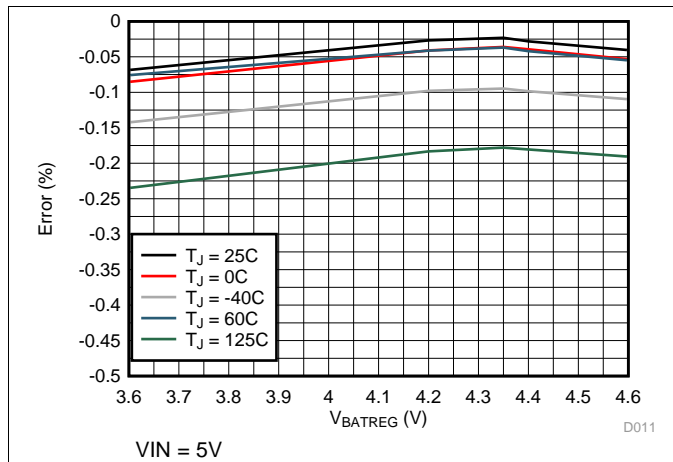

Figure 1. Battery Regulation Voltage Accuracy vs. VBATREG Setting

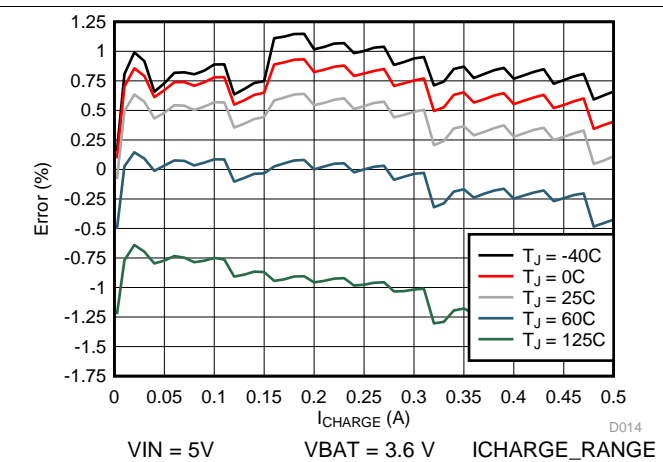

Figure 2. Charge Current Accuracy vs. ICHARGE setting

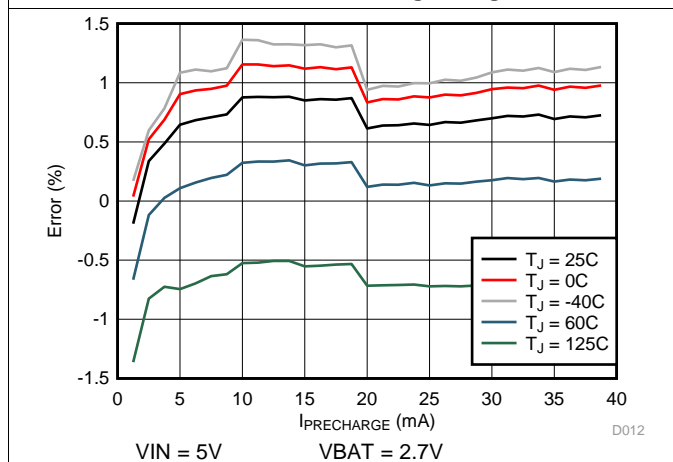

Figure 3. Pre-Charge Current Accuracy vs. IPRECHARGE setting (ICHARGE\_RANGE = 0)

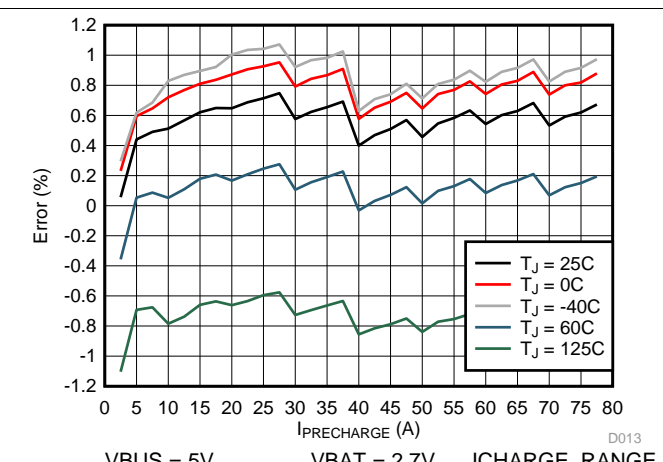

Figure 4. Pre-Charge Current Accuracy vs. IPRECHARGE Setting (ICHARGE\_RANGE = 1)

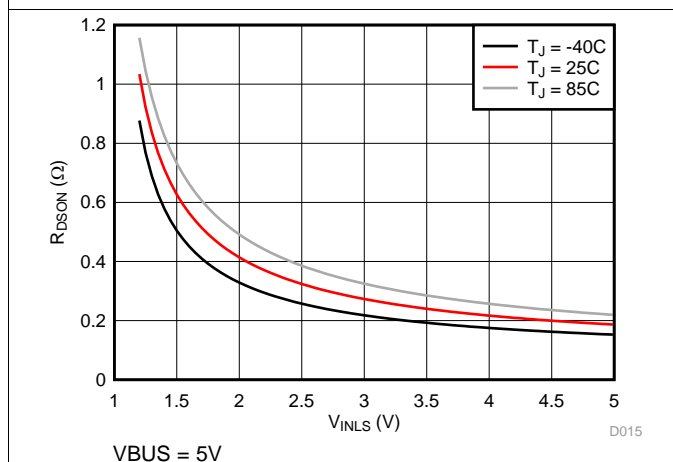

Figure 5. LS/LDO Switch On Resistance vs. VINLS

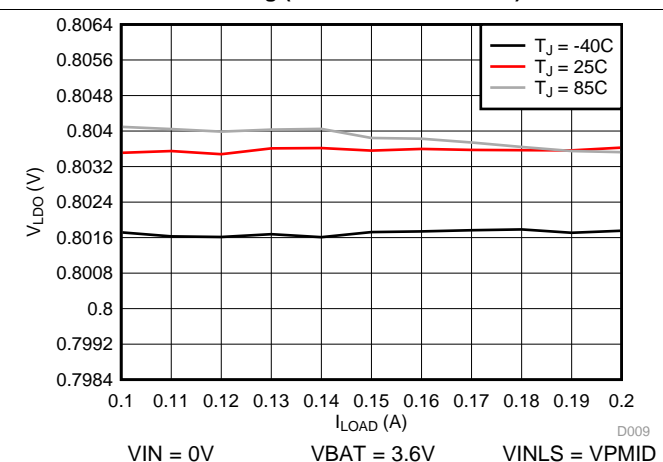
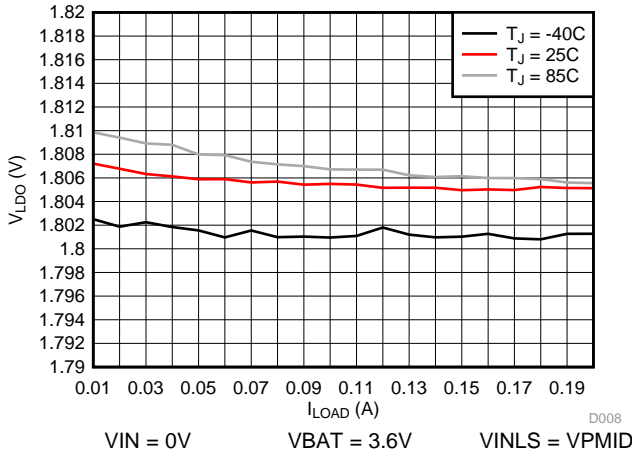

Figure 6. LDO Load Regulation (VLDO = 0.8V)

**Typical Characteristics (continued)**

$C_{IN} = 1\mu F$ ,  $C_{PMID} = 10\mu F$ ,  $C_{LSLDO} = 2.2\mu F$ ,  $C_{BAT} = 1\mu F$  (unless otherwise specified)



**Figure 7. LDO Load Regulation (VLDO = 1.8V)**

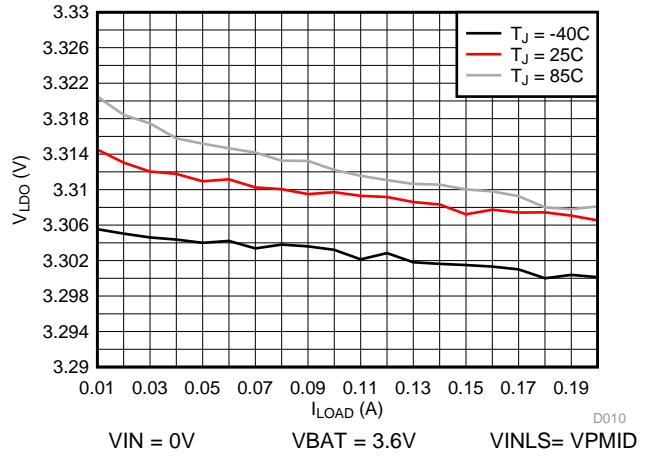

**Figure 8. LDO Load Regulation (VLDO = 3.3V)**

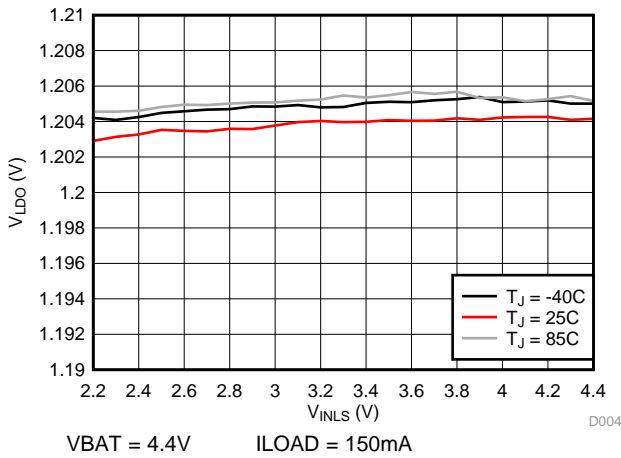

**Figure 9. LDO Line Regulation (VLDO = 1.2V)**

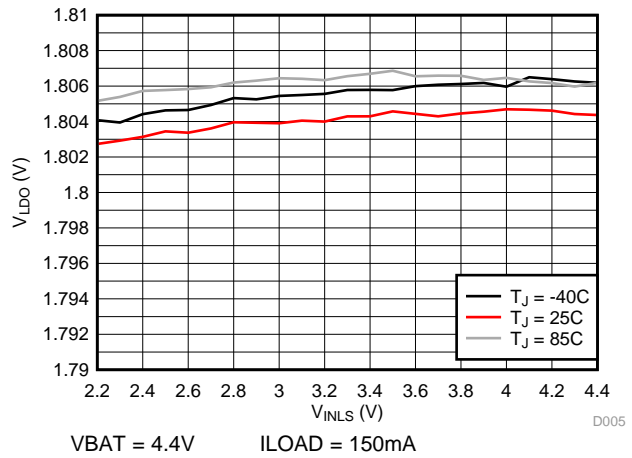

**Figure 10. LDO Line Regulation (VLDO = 1.8V)**

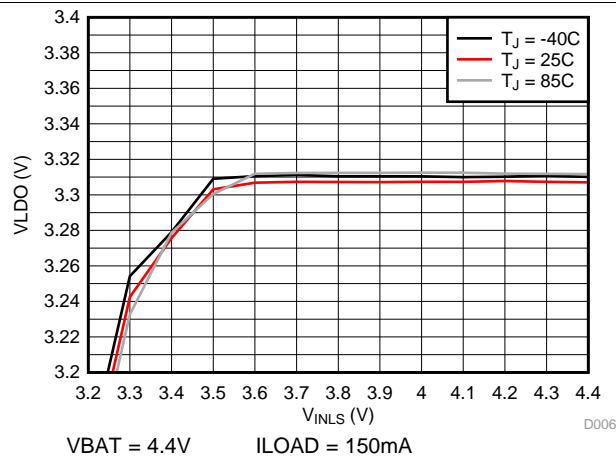

**Figure 11. LDO Line Regulation (VLDO = 3.3V)**

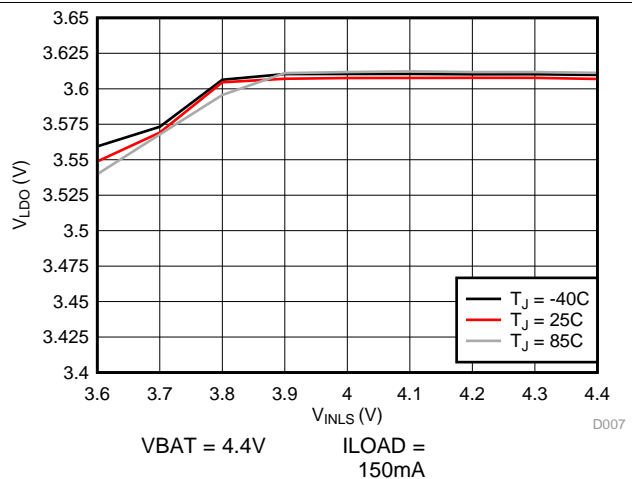

**Figure 12. LDO Line Regulation (VLDO = 3.6V)**

## 8 Detailed Description

### 8.1 Overview

The BQ25150 IC is a highly programmable battery management device that integrates a 500mA linear charger for single cell Li-Ion batteries, a 12-bit effective ADC, a general purpose LDO that may be configured as a load switch, and a push-button controller. Through its I<sup>2</sup>C interface the host may change charging parameters such as battery regulation voltage and charge current, and obtain detailed device status and fault information. The host may also read ADC measurements for battery and input voltage among other parameters, including the ADCIN pin voltage. The push-button controller allows the user to reset the system without any intervention from the host and wake up the device from Ship Mode.

### 8.2 Functional Block Diagram

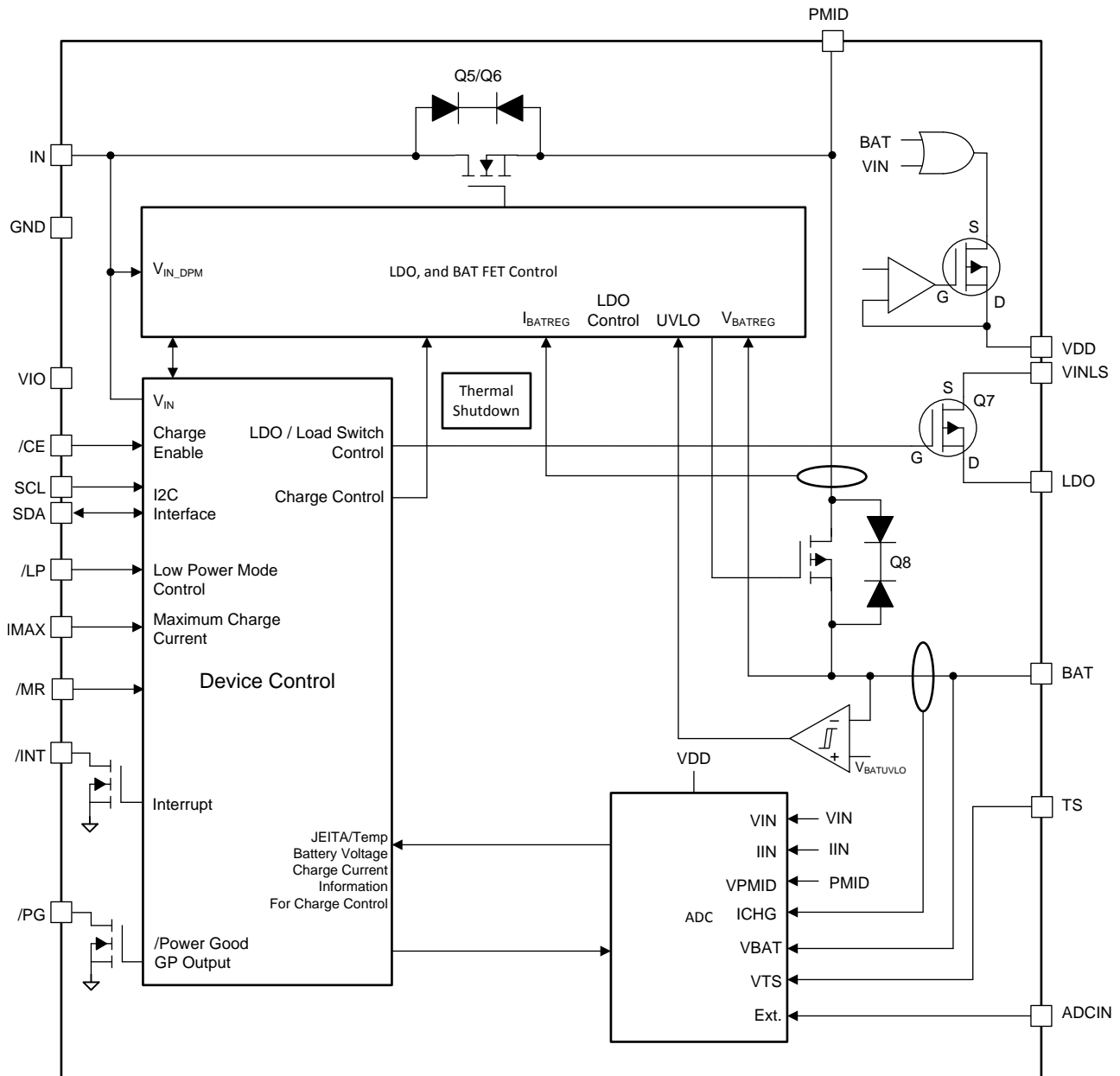

## 8.3 Feature Description

### 8.3.1 Linear Charger and Power Path

The BQ25150 IC integrates a linear charger that allows the battery to be charged with a programmable charge current of up to 500mA. In addition to the charge current, other charging parameters can be programmed through I<sup>2</sup>C such as the battery regulation voltage, pre-charge current, termination current, and input current limit current.

The power path allows the system to be powered from PMID, even when the battery is dead or charging, by drawing power from IN pin. It also prioritizes the system load connected to PMID, reducing the charging current, if necessary, in order support the load when input power is limited. If the input supply is removed and the battery voltage level is above  $V_{BATUVLO}$ , PMID will automatically and seamlessly switch to battery power.

There are several control loops that influence the charge current: constant current loop (CC), constant voltage loop (CV), input current limit, VDPPM, and VINDPM. During the charging process, all loops are enabled and the one that is dominant takes control regulating the charge current as needed. The charger input has back to back blocking FETs to prevent reverse current flow from PMID to IN. They also integrate control circuitry regulating the input current and prevents excessive currents from being drawn from the IN power supply for more reliable operation.

The device supports multiple battery regulation voltage regulation settings ( $V_{BATREG}$ ) and charge current ( $I_{CHARGE}$ ) options to support multiple battery chemistries for single-cell applications.

A more detailed description of the charger functionality is presented in the following sections of this document.

#### 8.3.1.1 Battery Charging Process

The following diagram summarizes the charging process of the BQ25150 charger.

Feature Description (continued)

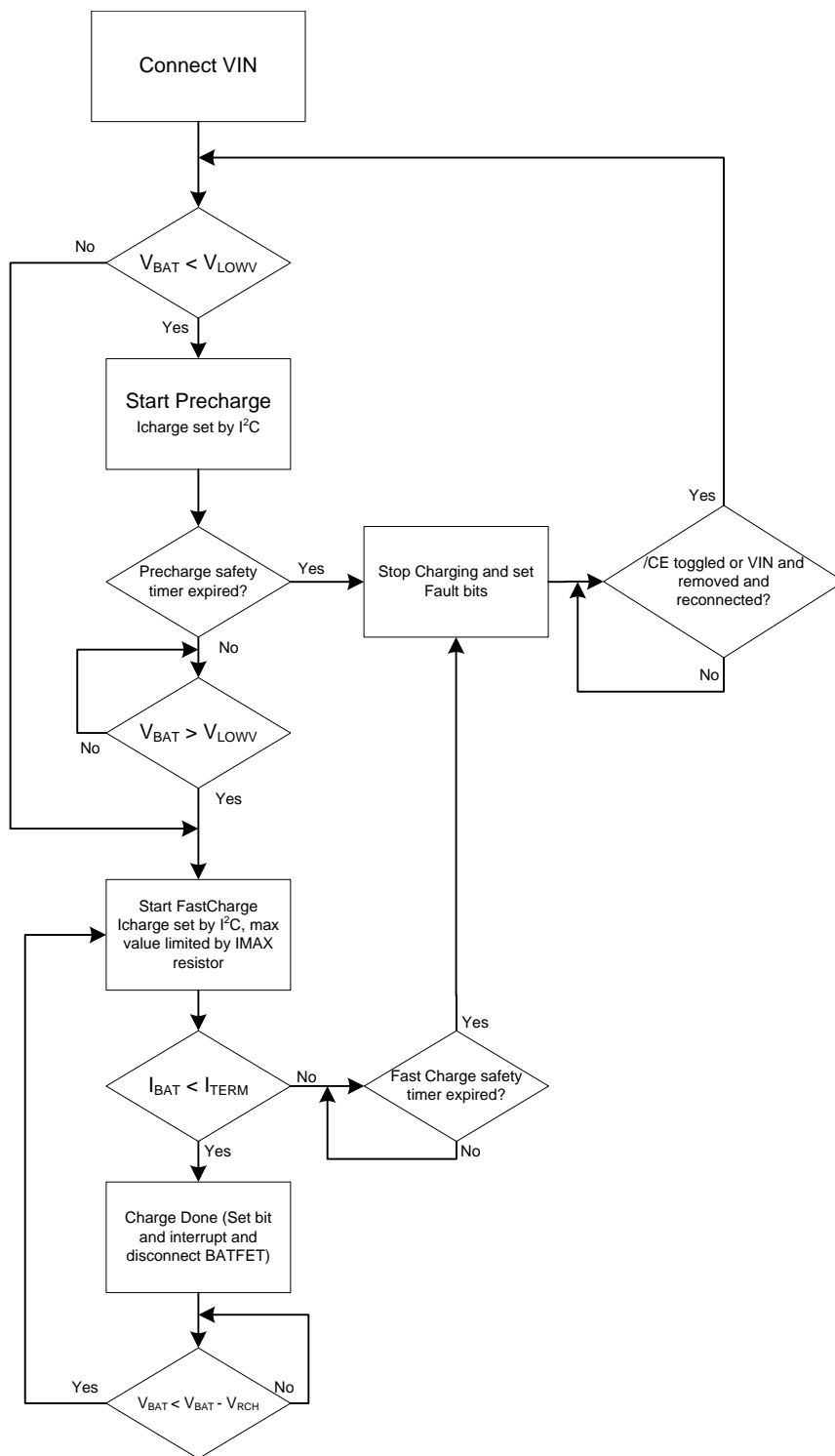

Figure 13. BQ25150 Charger Flow Diagram

**Feature Description (continued)**

When a valid input source is connected ( $V_{IN} > V_{UVLO}$  and  $V_{BAT} + V_{SLP} < V_{IN} < V_{OVP}$ ), the state of the  $\overline{CE}$  pin determines whether a charge cycle is initiated. When the  $\overline{CE}$  input is high and a valid input source is connected, the battery charge FET is turned off, preventing any kind of charging of the battery. A charge cycle is initiated when the CHARGE\_DISABLE bit is written to 0 and  $\overline{CE}$  pin in low. The following table shows the  $\overline{CE}$  pin and bit priority to enable/disable charging.

**Table 1. Charge Enable Function Through  $\overline{CE}$  Pin and  $\overline{CE}$  Bit**

$\overline{CE}$ PIN	CHARGE_DISABLE BIT	CHARGING
0	0	Enabled
0	1	Disabled
1	0	Disabled
1	1	Disabled

The following figure shows a typical charge cycle.

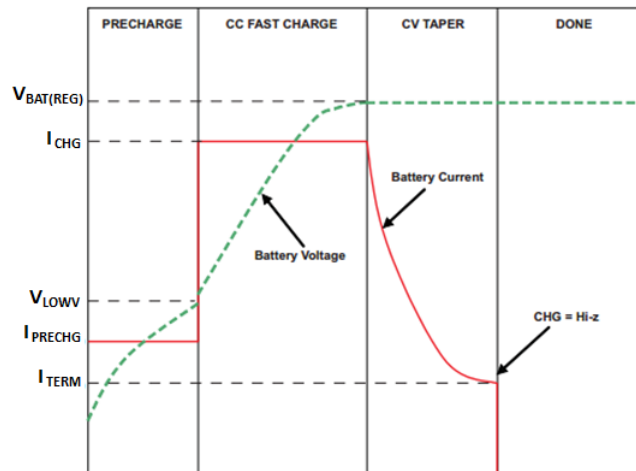

**Figure 14. BQ25150 Typical Charge Cycle**

**8.3.1.1.1 Pre-Charge**

In order to prevent damage to the battery, the device will charge the battery at a much lower current level when the battery voltage ( $V_{BAT}$ ) is below the  $V_{LOWV}$  level. The pre-charge current ( $I_{PRECHARGE}$ ) can be programmed through I<sup>2</sup>C. Once the battery voltage reaches  $V_{LOWV}$ , the charger will then operate in Fast Charge Mode, charging the battery at  $I_{CHARGE}$ .

During pre-charge, the safety timer is set to 25% of the safety timer value during fast charge.

**8.3.1.1.2 Fast Charge**

The charger has two main control loops that control charging when  $V_{BAT} > V_{LOWV}$ : the Constant Current (CC) and Constant Voltage (CV) loops. When the CC loop is dominant, typically when  $V_{BAT} < V_{BATREG} - 50\text{ mV}$ , the battery is charged at the maximum charge current level  $I_{CHARGE}$ , unless there is a TS fault condition (JEITA operation), thermal charge current foldback is active, VINDPM is active, or DPPM is active. (See respective sections for details on these modes of operation). Once the battery voltage approaches the  $V_{BATREG}$  level, the CV loop becomes more dominant and the charging current starts tapering off as shown in Figure 14. Once the charging current reaches the termination current ( $I_{TERM}$ ) charging is stopped.

The maximum fast charge current is limited by the IMAX resistor setting, even if a higher I<sup>2</sup>C value is programmed. See [Maximum Allowable Charging Current \(IMAX\)](#) for details on IMAX function.



### 8.3.1.1.3 Pre-Charge to fast Charge Transitions and Charge Current Ramping

Whenever a change in the charge current setting is triggered, whether it occurs due to I<sup>2</sup>C programming by the host, Pre-Charge/Fast Charge transition or JEITA TS control, the device will temporarily disable charging (for ~ 1ms) before updating the charge current value.

#### 8.3.1.1.4 Termination

The device will automatically terminate charging once the charge current reaches  $I_{TERM}$ , which is programmable through I<sup>2</sup>C.

After termination the charger will operate in high impedance mode, disabling the BATFET to disconnect the battery. Power is provided to the system (PMID) by IN supply as long and  $V_{IN} > V_{UVLO}$  and  $V_{BAT} + V_{SLP} < V_{IN} < V_{OVP}$ .

Termination is only enabled when the charger CV loop is active in fast charge operation. No termination will occur if the charge current reaches  $I_{TERM}$  while VINDPM or DPPM is active as well as the thermal regulation loop. Termination is also disabled when operating in the TS WARM region. The charger only goes to termination when the current drops to  $I_{TERM}$  due to the battery reaching the target voltage and not due to the charge current limitation imposed by the previously mentioned control loops.

### 8.3.1.2 JEITA and Battery Temperature Dependent Charging

The charger can be configured through I<sup>2</sup>C setting to provide JEITA support, automatically reducing the charging current and voltage depending on the battery temperature as monitored by an NTC thermistor connected to the BQ25150 TS pin. See [External NTC Monitoring \(TS\)](#) for details.

### 8.3.1.3 Input Voltage Based Dynamic Power Management (VINDPM)

The VINDPM loop prevents the input voltage from collapsing to a point where charging would be interrupted by reducing the current drawn by charger in order to keep  $V_{IN}$  from dropping below  $V_{IN\_DPM}$ .

During the normal charging process, if the input power source is not able to support the programmed or default charging current and system load, the voltage at the IN pin decreases. Once the IN voltage drops to  $V_{IN\_DPM}$ , the VINDPM current and voltage loops will reduce the input current through the blocking FETs, to prevent the further drop of the supply voltage. The  $V_{IN\_DPM}$  threshold is programmable through the I<sup>2</sup>C register from 4.2 V to 4.9 V in 100 mV steps. It can be disabled completely as well. When the device enters this mode, the charge current may be lower than the set value and the  $V_{INDPM\_STAT}$  bit is set. If the 2X timer is set, the safety timer is extended while  $V_{IN\_DPM}$  is active. Additionally, termination is disabled.

### 8.3.1.4 Dynamic Power Path Management Mode (DPPM)

With a valid input source connected, the power-path management circuitry monitors the input voltage and current continuously. The current into IN is shared at PMID between charging the battery and powering the system load connected at PMID. If the sum of the charging and load currents exceeds the preset maximum input current set by ILIM, PMID starts to drop. If PMID drops below the DPPM voltage threshold, the charging current is reduced by the DPPM loop through the BATFET. If PMID continues to drop after BATFET charging current is reduced to zero, the part will enter supplement mode when PMID falls below the supplement mode threshold ( $V_{BAT} - V_{BSUP1}$ ). Battery termination is disabled while in DPPM mode. The  $V_{DPPM}$  threshold is typically 200 mV above  $V_{BAT}$ . This will enable supporting lower input voltages to minimize losses through the linear charger.

### 8.3.1.5 Battery Supplement Mode

While in DPPM mode, if the charging current falls to zero and the system load current increases beyond the programmed input current limit, the voltage at PMID reduces further. When the PMID voltage drops below the battery voltage by  $V_{BSUP1}$ , the battery supplements the system load. The battery stops supplementing the system load when the voltage on the PMID pin rises above the battery voltage by  $V_{BSUP2}$ . During supplement mode, the battery supplement current is not regulated, however, the Battery Over-Current Protection mechanism is active. Battery charge termination is disabled while in supplement mode.

## 8.3.2 Protection Mechanisms

### 8.3.2.1 Input Over-Voltage Protection

The input over-voltage protection protects the device and downstream components connected to PMID, and BAT against damage from over-voltage on the input supply. When  $V_{IN} > V_{OVP}$  an OVP fault is determined to exist. During the OVP fault, the device turns the input FET off, sends a single 128 us pulse on  $\overline{INT}$ , and the VIN\_OVP\_FAULT FLAG and STAT bits are updated over I<sup>2</sup>C. Once the OVP fault is removed, the STAT bit is cleared and the device returns to normal operation. The FLAG bit is not cleared until it is read through I<sup>2</sup>C after the OVP condition no longer exists. The OVP threshold for the device is 5.5 V to allow operation from standard USB sources.

### 8.3.2.2 Safety Timer and I<sup>2</sup>C Watchdog Timer

At the beginning of the charge cycle, the device starts the safety timer. If charging has not terminated before the programmed safety time,  $t_{MAXCHG}$ , expires, charging is disabled. The pre-charge safety time,  $t_{PRECHG}$ , is 25% of  $t_{MAXCHG}$ . When a safety timer fault occurs, a single 128us pulse is sent on the  $\overline{INT}$  pin and the SAFETY\_TMR\_FAULT\_FLAG bit in the FLAG3 register is updated over I<sup>2</sup>C. The  $\overline{CE}$  pin or input power must be toggled in order to reset the safety timer and exit the fault condition. Note that the flag bit will be reset when the bit is read by the host even if the fault has not been cleared. The safety timer duration is programmable using the SAFETY\_TIMER bits. When the safety timer is active, changing the safety timer duration resets the safety timer. The device also contains a 2X\_TIMER bit that doubles the timer duration prevent premature safety timer expiration when the charge current is reduced by a high load on PMID (DPM operation), VIN DPM, thermal regulation, or a NTC (JEITA) condition. When 2X\_TIMER function is enabled, the timer is allowed to run at half speed when any loop is active other than CC or CV.

In addition to the safety timer, the device contains a 50-second I<sup>2</sup>C watchdog timer that monitors the host through the I<sup>2</sup>C interface. The watchdog timer is enabled by default and may be enabled by the host through I<sup>2</sup>C. Once the watchdog timer is enabled, the watchdog timer is started. The watchdog timer is reset by any transaction by the host using the I<sup>2</sup>C interface. If the watchdog timer expires without a reset from the I<sup>2</sup>C interface, all charger parameters registers (ICHARGE, IPRECHARGE, ITERM, VLOWV, etc) are reset to the default values.

### 8.3.2.3 Thermal Protection and Thermal Charge Current Foldback

During operation, to protect the device from damage due to overheating, the junction temperature of the die,  $T_J$ , is monitored. When  $T_J$  reaches  $T_{SHUTDOWN}$  the device stops operation and is turned off. The device resumes operation when  $T_J$  falls below  $T_{SHUTDOWN}$  by  $T_{HYS}$ .

During the charging process, to prevent overheating in the device, the device monitors the junction temperature of the die and reduces the charging current at a rate of  $(0.04 \times I_{CHARGE})/^\circ\text{C}$  once  $T_J$  exceeds the thermal foldback threshold,  $T_{REG}$ . If the charge current is reduced to 0, the battery supplies the current needed to supply the PMID output. The thermal regulation threshold may be set through I<sup>2</sup>C by setting the THERM\_REG bits to the desired value.

To ensure that the system power dissipation is under the limits of the device. The power dissipated by the device can be calculated using the following equation:

$$P_{DISS} = P_{PMID} + P_{LS/LDO} + P_{BAT} \quad (1)$$

Where:

$$P_{PMID} = (V_{IN} - V_{PMID}) \times I_{IN} \quad (2)$$

$$P_{LS/LDO} = (V_{INLS} - V_{LS/LDO}) \times I_{LS/LDO} \quad (3)$$

$$P_{BAT} = (V_{PMID} - V_{BAT}) \times I_{BAT} \quad (4)$$

The die junction temperature,  $T_J$ , can be estimated based on the expected board performance using the following equation:

$$T_J = T_A + \theta_{JA} \times P_{DISS} \quad (5)$$

The  $\theta_{JA}$  is largely driven by the board layout. For more information about traditional and new thermal metrics, see the IC Package Thermal Metrics application report SPRA953. Under typical conditions, the time spent in this state is very short.

### 8.3.2.4 Battery Short and Over Current Protection

In order to protect the device from over current and prevent excessive battery discharge current, BQ25150 detects if the current on the battery FET exceeds  $I_{BAT\_OCP}$ . If the short circuit limit is reached for the deglitch time ( $t_{DGL\_OCP}$ ), the battery discharge FET is turned off and start operating in hiccup mode, re-enabling the BATFET  $t_{REC\_SC}$  (250ms) after being turned off by the over-current condition. If the over-current condition is triggered upon retry for 3 to 7 consecutive times, the BATFET will then remain off until the part is reset or until  $V_{IN}$  is connected and valid. If the over-current condition and hiccup operation occurs while in supplement mode where  $V_{IN}$  is already present,  $V_{IN}$  must be toggled in order for BATFET to be enabled and start another detection cycle.

This process protects the internal FET from over current. During this event  $PMID$  will likely droop and cause the system to shut down. It is recommended that the host read the Faults Register after waking up to determine the cause of the event.

In the case where the battery is suddenly shorted while charging and  $V_{BAT}$  drops below  $V_{SHORT}$ , a fast comparator quickly reduces the charge current to  $I_{PRECHARGE}$  preventing fast charge current to be momentarily injected to the battery while shorted.

### 8.3.2.5 PMID Short Circuit

A short on the  $PMID$  pin is detected when the  $PMID$  voltage drops below 1.6V ( $PMID$  short threshold).  $PMID$  short threshold has a 200mV hysteresis. When this occurs, the input FET temporarily disconnects  $IN$  for up to 200 $\mu$ s to prevent stress on the device if a sudden short condition happens, before allowing a softstart on the  $PMID$  output.

### 8.3.2.6 Maximum Allowable Charging Current ( $IMAX$ )

The device allows the system designer to limit the maximum programmable charge current through hardware by connecting a resistor to the  $IMAX$  pin. The value of this resistor will determine the maximum Fast Charge  $I^2C$  code that BQ25150 would let the host program to the device. Upon Power-On-Reset (POR) the ADC will measure the voltage at the  $IMAX$  pin, which is biased by a 80 $\mu$ A biasing current. This measurement is used to determine the  $R_{IMAX}$  value and the maximum charging current. Once the value is measured, the device determines the maximum allowable Fast Charge  $I^2C$  code and prevents the host from programming any value higher than that. If the host tries to program it to a higher value, the  $IMAX\_ACTIVE$  flag will be set and the Fast Charge Current Register will reflect the maximum charge current setting instead of the value programmed by the host. Note that even though the pre-charge current is also limited by  $IMAX$  if set higher than the  $IMAX$  value, the  $IMAX\_ACTIVE$  flag is not set as it is only asserted for fast charge. The equation below shows the maximum  $ICHG\_CTRL$  register value (decimal) for a given  $R_{IMAX}$ .

$$ICHRG\_CTRL_{(CODE\_IN\_DECIMAL)} = \frac{2 \times R_{IMAX} \times 80\mu}{1.2} \times 2^8 \quad (6)$$

Note that the  $IMAX$  function has no effect on the charge current step size set by the  $ICHARGE\_RANGE$  bit, so if  $R_{IMAX}$  is selected based on the fast charge current when  $ICHARGE\_RANGE = 0$  (1.25mA step), changing the  $ICHARGE\_RANGE$  bit to 1 will double the maximum allowable current. In case where the  $IMAX$  pin is left floating ( $R_{IMAX} > 14K\Omega$ ), the device will disable charging so that in the case the  $IMAX$  resistor connection is not done properly during manufacturing or breaks afterwards it prevents charging with a current above the desired  $IMAX$  level. If the measurement indicates that the  $IMAX$  pin is floating, the device repeats the measurement for a second time to confirm. If the floating pin measurement is confirmed then, charge is disabled permanently and the  $IMAX\_FAULT$  flag is set. Note that a Power-On-Reset (POR) would be needed in order to repeat the  $IMAX$  measurement so both  $IN$  and  $BAT$  supplies must be removed before powering up the device again to update the  $IMAX$  state.

### 8.3.3 ADC

The device uses a 12-bit effective ADC to report information on the input voltage, input current, PMID voltage, battery voltage, battery charge current, and TS pin voltage of the device. It can also make measurements from an external source through the ADCIN pin.

The host may select the function desired, perform an ADC read, and then read the values in the ADC registers. The details for the register functions are in [Register Map](#).

#### 8.3.3.1 ADC Operation in Active Battery Mode and Low Power Mode

When the device is powered by the battery it is imperative that power consumption is minimized in order to maximize battery life. In order to limit the number of ADC conversions, and hence power consumption, the ADC conversions when in Active Battery Mode may be limited to a period determined by the ADC\_READ\_RATE bits. On the case where the ADC\_READ\_RATE is set to Manual Mode, the host will have to set the ADC\_CONV\_START bit to initiate the ADC conversion. Once the ADC conversion is completed and the data is ready, the ADC\_READY flag will be set and an interrupt will be sent to the host. In Low Power Mode the ADC remains OFF for minimal IC power consumption. The host will need to switch to Active Battery Mode (set LP high) before performing an ADC measurement.

#### 8.3.3.2 ADC Operation When VIN Present

When VIN is present and VDD is powered from VIN, the ADC is constantly active, performing conversions continuously. The device will not send an interrupt after a conversion is complete since this would force the device to constantly send ADC\_READY interrupts that would overwhelm the host. The host will be able to read the ADC results registers at any time. This is true even when  $V_{IN} > V_{OVP}$ .

#### 8.3.3.3 ADC Measurements

The table below list the ADC measurements done by the ADC.

**Table 2. ADC Measurement Channels**

MEASUREM NT	FULL SCALE RANGE (ABSOLUTE MAX CODE)	FULL LINEAR RANGE (RECOMMENDED OPERATING RANGE)	FORMULA
VIN	6 V	2V - 5V	$V_{IN} = \frac{ADCDATA\_VIN^{16bit}}{2^{16}} \times 6V$ (7)
PMID	6 V	2V- 5V	$V_{PMID} = \frac{ADCDATA\_PMID^{16bit}}{2^{16}} \times 6V$ (8)
IIN	750 mA	0 - 600 mA	For ILIM ≤ 150mA: $I_{IN} = \frac{ADCDATA\_IIN^{16bit}}{2^{16}} \times 375mA$ (9) For ILIM > 150mA: $I_{IN} = \frac{ADCDATA\_IIN^{16bit}}{2^{16}} \times 750mA$ (10) Note: IIN reading only valid when $V_{IN} > V_{UVLO}$ and $V_{IN} < V_{OVP}$
VBAT	6 V	2V - 5 V	$VBAT = \frac{ADCDATA\_VBAT^{16bit}}{2^{16}} \times 6V$ (11)
TS	1.2 V	0 - 1 V	$V_{TS} = \frac{ADCDATA\_TS^{16bit}}{2^{16}} \times 1.2V$ (12)

**Table 2. ADC Measurement Channels (continued)**

MEASUREMENT	FULL SCALE RANGE (ABSOLUTE MAX CODE)	FULL LINEAR RANGE (RECOMMENDED OPERATING RANGE)	FORMULA
ADCIN	1.2 V	0 - 1 V	$V_{ADCIN} = \frac{ADCDATA\_ADCIN^{16bit}}{2^{16}} \times 1.2V$ <span style="float: right;">(13)</span>
% ICHARGE	-	-	$\% I_{CHARGE} = \frac{ADCDATA\_ICHG^{16bit}}{0.8 \times 2^{16}} \times 100$ <span style="float: right;">(14)</span> <p>where <math>I_{CHARGE}</math> is the fast charge current set by ICHG_CTRL register and ICHARGE_RANGE bit.</p>

### 8.3.3.4 ADC Programmable Comparators

BQ25150 has three programmable ADC comparators that may be used to monitor any of the ADC channels. The comparators will send an interrupt whenever the ADC measurement the comparator is monitoring crosses the thresholds programmed in their respective ADC\_ALARM\_COMPx registers in the direction indicated by the x\_ADCALARM\_ABOVE bit. Note that the interrupts are masked by default and must be unmasked by the host to use this function.

ADC\_COMP1 may be used to monitor critical conditions that need continuous and autonomous monitoring after a condition is detected. This comparator will force continuous ADC readings when the condition the ADC comparator is detecting is true regardless of ADC\_READ\_RATE setting until the condition is no longer present. Note that the continuous ADC reading will cause an increase in quiescent current, so it is recommended to disable ADC\_COMP1 by setting the ADC\_COMP1 bits to 000 if this function is not to be used.

### 8.3.4 VDD LDO

The device integrates a low current always on LDO that serves as the digital I/O supply to the device. This LDO is supplied by VIN or by BAT. The end user may be able to draw up to 10mA of current through the VDD pin to power a status LED or provide an IO supply. The VDD LDO will remain on through all power states with the exception of Ship Mode.

### 8.3.5 Load Switch / LDO Output and Control

The device integrates a low Iq load switch which can also be used as a regulated output. The LDO/LS has a dedicated input pin VINLS and can support up to 150 mA of load current

The LSCTRL may be enabled/disabled through I<sup>2</sup>C. To limit voltage drop or voltage transients, a small ceramic capacitor must be placed close to VINLS pin. Due to the body diode of the PMOS switch, it is recommended to have the capacitor on VINLS ten times larger than the output capacitor on LS/LDO output.

The output voltage is programmable using the LS\_LDO bits in the registers. The LS\_LDO output can only be changed when the EN\_LS\_LDO or LSCTRL pin have disabled the output. The LS/LDO voltage is calculated using the following equation:  $V_{LSLDO} = 0.6 V + LS\_LDOCODE \times 100 mV$  up to 3.7 V. All higher codes will set the output to 3.7V.

**Table 3. LDO Mode Control**

I2C EN_LS_LDO	LS_CONFIG	LS/LDO OUTPUT
0	0	Pulldown
0	1	Pulldown
1	0	LDO
1	1	Load Switch

The current capability of the LDO will depend on the VINLS input voltage and the programmed output voltage. When the LS/LDO output is disabled through the register, an internal pull-down will discharge the output.

The LDO has output current limit protection, limiting the output current in the event of a short in the output. When the LDO output current limit trips and is active for at least 1ms, the device will set a flag and send an interrupt to the host. The LDO may be set to operate as a load switch by setting the LS\_SWITCH\_CONFIG bit. Note that in order to change the configuration the LDO must be disabled first, then the LS\_SWITCH\_CONFIG bit is set for it to take effect.

### 8.3.6 PMID Power Control

BQ25150 offers the option to control PMID through the I<sup>2</sup>C PMID\_MODE bits. These bits can force PMID to be supplied by BAT instead of IN, even if  $V_{IN} > V_{BAT} + V_{SLP}$ . They can also disconnect PMID, pulling it down or leaving it floating. The table below shows the expected device behavior based on PMID\_MODE setting as detailed in the table below.

**Table 4. PMID\_MODE Control**

PMID_MODE	DESCRIPTION	PMID SUPPLY	PMID PULL-DOWN
00	Normal Operation	IN or BAT	Off
01	Force BAT Power	BAT	Off
10	PMID Off - Floating	None	Off
11	PMID Off - Pulled Down	None	On

#### PMID\_MODE = 00

This is the default state/normal operation of the device. PMID will be powered from IN if VIN is valid or it will be powered by BAT. PMID will only be disconnected from IN or BAT and pulled down when a HW Reset occurs or the device goes into Ship Mode.

#### PMID\_MODE = 01

When this configuration is set, PMID will be powered by BAT if  $V_{BAT} > V_{BATUVLO}$  regardless of VIN or  $\overline{CE}$  state. This allows the host to minimize the current draw from the adapter while it is still connected to the system. If PMID\_MODE = 01 is set while  $V_{BAT} < V_{BATUVLO}$ , the PMID\_MODE = 01 setting will be ignored and the device will go to PMID\_MODE = 00. If VBAT drops below VBATUVLO while PMID\_MODE = 01 the device will automatically switch to PMID\_MODE=00. This prevents the device from needing a POR in order to restore power to the system and allow battery charging. If PMID\_MODE = 01 is set during charging, charging will be stopped and the battery will start to provide power to PMID as needed.

#### PMID\_MODE = 10

When this configuration is set, PMID will be disconnected from the supply (IN or BAT) and left floating. VDD and the digital remain on and active. The LDO will be disabled. When floating, PMID can only be forced to a voltage up to VBAT level. Note that this mode can only be exited through I<sup>2</sup>C or  $\overline{MR}$  HW Reset.

#### PMID\_MODE = 11

When this configuration is set, PMID will be disconnected from the supply (IN or BAT) and pulled down to ground. VDD and the digital remain on and active. The LDO will be disabled. Note that this mode can only be exited through I<sup>2</sup>C or  $\overline{MR}$  HW Reset.

### 8.3.7 MR Wake and Reset Input

The  $\overline{MR}$  input has three main functions in BQ25150. First, it serves as a means to wake the device from Ship Mode. Second, it serves as a short button press detector, sending an interrupt to the host when the button driving the  $\overline{MR}$  pin has been pressed for a given period of time. This allows the implementation of different functions in the end application such as menu selection and control. And finally it serves as a mean to get BQ25150 to reset the system by performing a power cycle (shut down PMID and automatically powering it back on) or go to Ship Mode after detecting a long button press. The timing for the short and long button press duration is programmable through I<sup>2</sup>C for added flexibility and allow system designers to customize the end user experience of a specific application. Note that if a specific timer duration is changed through I<sup>2</sup>C while that timer is active and has not expired, the new programmed value will be ignored until the timer expires and/or is reset by  $\overline{MR}$ . The  $\overline{MR}$  input has an internal pull-up to BAT.

### 8.3.7.1 $\overline{MR}$ Wake or Short Button Press Functions

There are two programmable wake or short button press timers, WAKE1 and WAKE2. When the  $\overline{MR}$  pin is held low for  $t_{WAKE1}$  the device sends an interrupt (128us active low pulse in the INT pin) and sets the MRWAKE1\_TIMEOUT flag when it expires. If the  $\overline{MR}$  pin continues to be driven low after WAKE1 and the WAKE2 timer expires, BQ25150 sends a second interrupt and sets the MRWAKE2\_TIMEOUT flag. WAKE2 is used as the timer to wake the device from ship mode. WAKE2's only function is to send the interrupt and has no effect on other BQ25150 functions. These flags are not cleared until they have been read by the host. Note that interrupts are only sent when the flags are set and the flags must be cleared in order for another interrupt to be sent upon  $\overline{MR}$  press. The timer durations can be set through the MR\_WAKE $x$ \_TIMER bits in the MRCTRL register.

One of the main  $\overline{MR}$  functions is to wake the device from Ship Mode when the  $\overline{MR}$  is asserted. The device will exit the Ship Mode when the  $\overline{MR}$  pin is held low for at least  $t_{WAKE2}$ . Immediately after the  $\overline{MR}$  is asserted, VDD will be enabled and the digital will start the WAKE counter. If the  $\overline{MR}$  signal remains low until after the WAKE2 timer expires, the device will power up PMID and LDO (If enabled) completing the exit from the ship mode. If the  $\overline{MR}$  signal goes high before the WAKE2 timer expires, the device will go back to the Ship Mode operation, never powering up PMID or the LDO. Note that if the  $\overline{MR}$  pin remains low after exiting Ship Mode the wake interrupts will not be sent and the long button press functions like HW reset will not occur until the  $\overline{MR}$  pin is toggled. In the case where a valid  $V_{IN}$  ( $V_{IN} > V_{UVLO}$ ) is connected prior to WAKE2 timer expiring, the device will exit the ship mode immediately regardless of the  $\overline{MR}$  or wake timer state. Figure 15 and Figure 16 show these different scenarios.

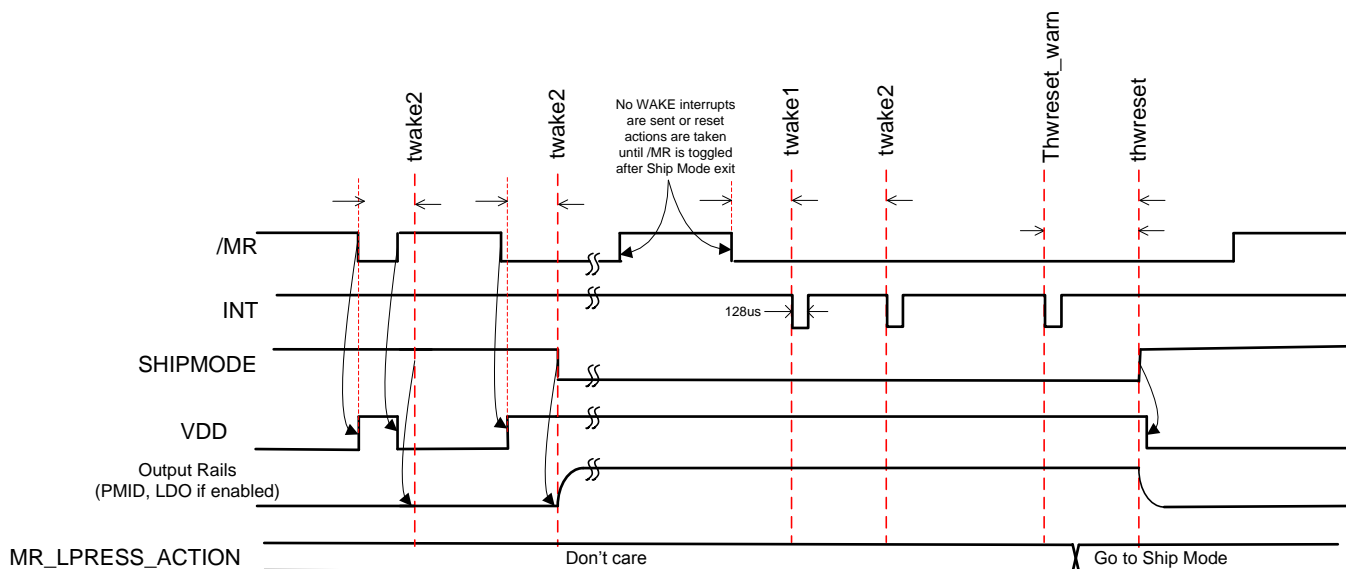
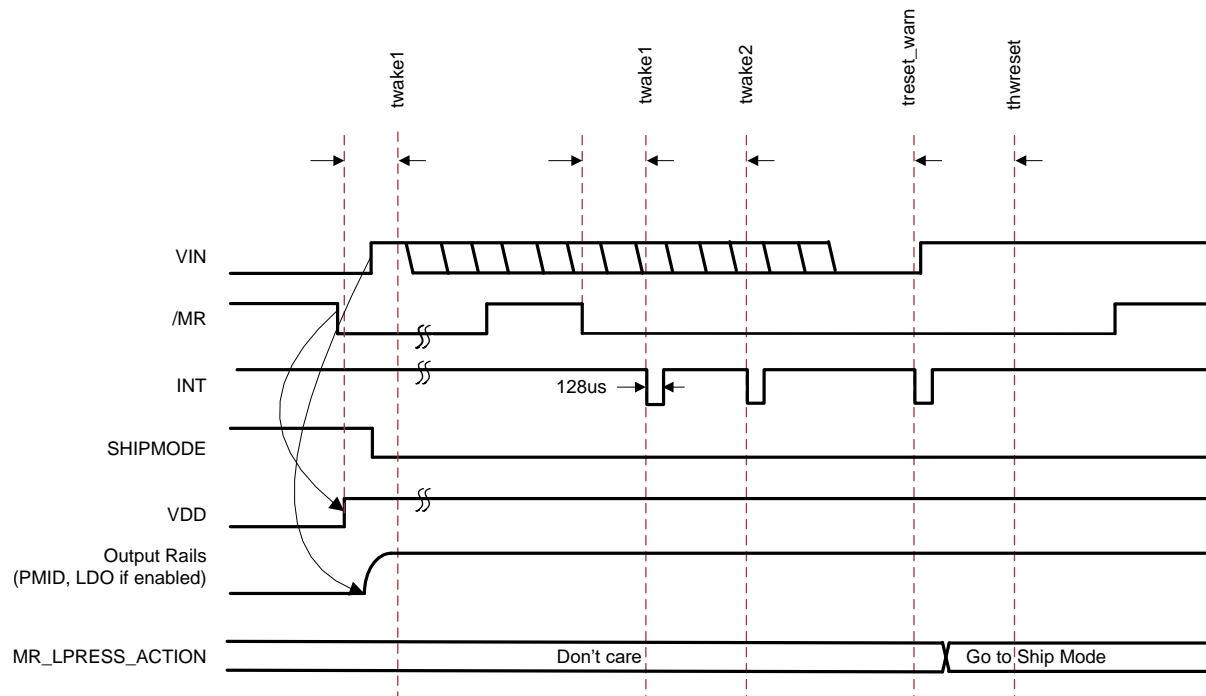

Figure 15. MR Wake from Ship Mode (MR\_LPRESS\_ACTION = Ship Mode, VIN not valid)



**Figure 16. MR Wake from Ship Mode – VIN dependencies**

### 8.3.7.2 $\overline{MR}$ Reset or Long Button Press Functions

The BQ25150 device may be configured to perform a system hardware reset (Power Cycle/Autowake), go into Ship Mode, or simply do nothing after a long button press (i.e. when the  $\overline{MR}$  pin is driven low until the  $MR\_HW\_RESET$  timer expires). The action taken by the device when the timer expires is configured through the  $MR\_LPRESS\_ACTION$  bits in the [ICCTRL1 register](#). Once the  $MR\_HW\_RESET$  timer expires the device immediately performs the operation set by the  $MR\_LPRESS\_ACTION$  bits. The BQ25150 sends an interrupt to the host when the device detects that  $\overline{MR}$  has been pressed for a period that is within  $t_{HW\_RESET\_WARN}$  from reaching  $t_{HW\_RESET}$ . This may warn the host that the button has been pressed for a period close to  $t_{HW\_RESET}$  which would trigger a HW Reset or used as another button press timer interrupt like the WAKE1 and WAKE2 timers. This interrupt is sent before the  $MR\_HW\_RESET$  timer expires and sets the  $MRRESET\_WARN$  flag. The  $t_{HW\_RESET\_WARN}$  may be set through I<sup>2</sup>C by the  $MR\_RESET\_WARN$  bits in the [MRCTRL register](#). The host may change the reset behavior at any time after  $\overline{MR}$  going low and prior to the  $MR\_HW\_RESET$  timer expiring. It may not change it however from another behavior to a HW reset (Power Cycle/Autowake) since a HW reset can be gated by other condition requirements, such as VIN presence (controlled by  $MR\_RESET\_VIN$  bit), throughout the whole duration of the button press. This flexibility allows the host to abort any reset or power shutdown to the system by overriding a long button press command.

A HW Reset may also be started by setting the  $HW\_RESET$  bit. Note that during a HW reset, VDD remains on.



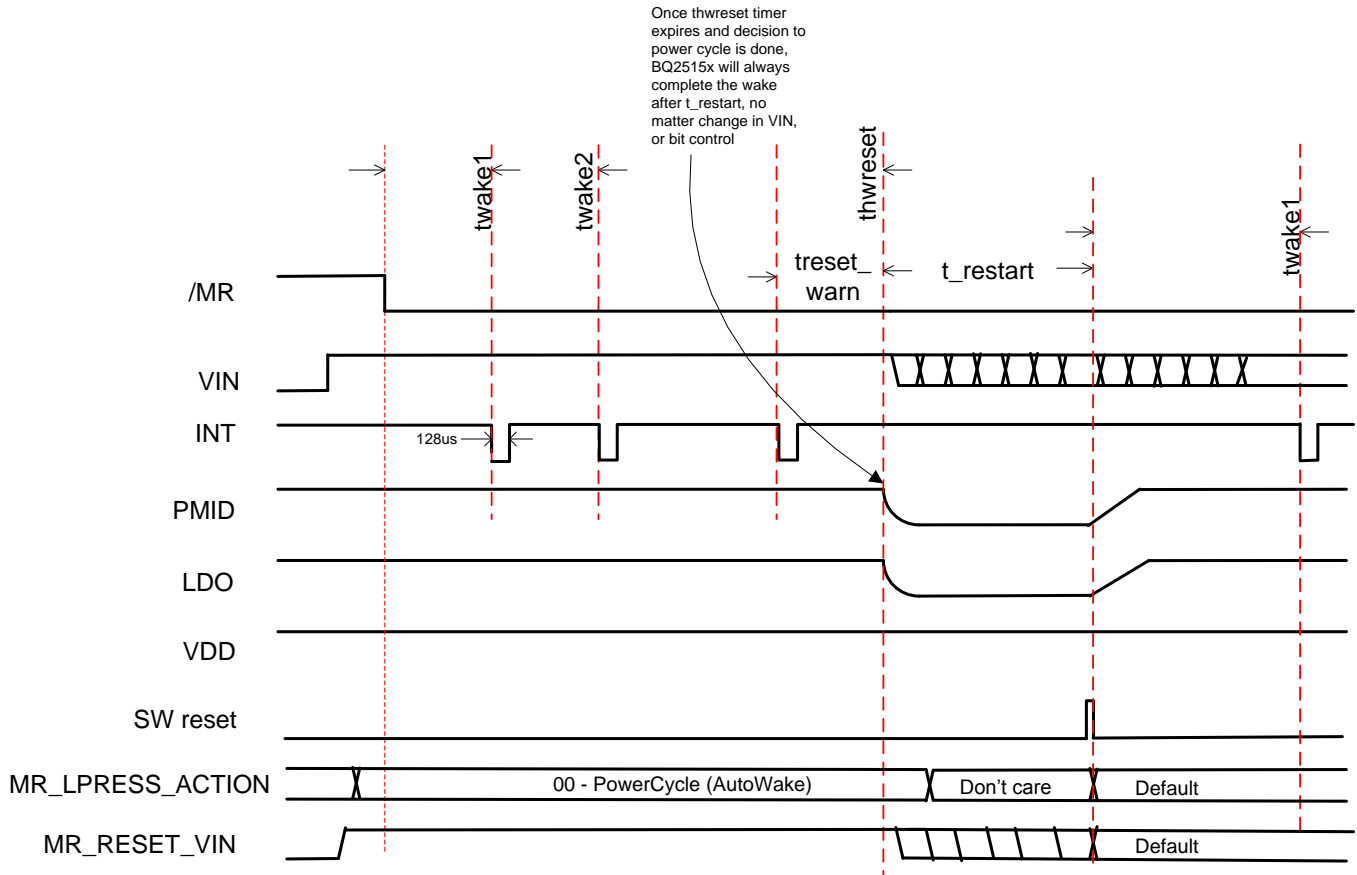

Figure 17. MR Wake and Reset Timing with VIN present or BAT Active Mode When MR\_LPRESS\_ACTION = 00

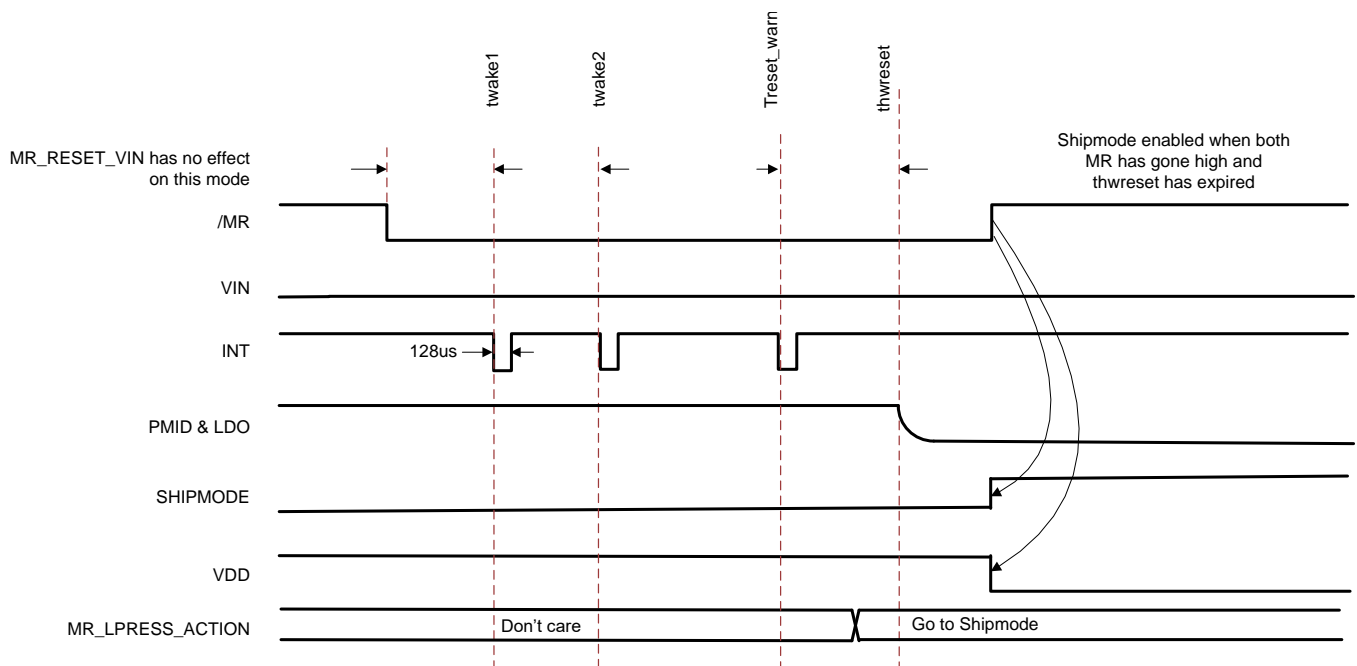
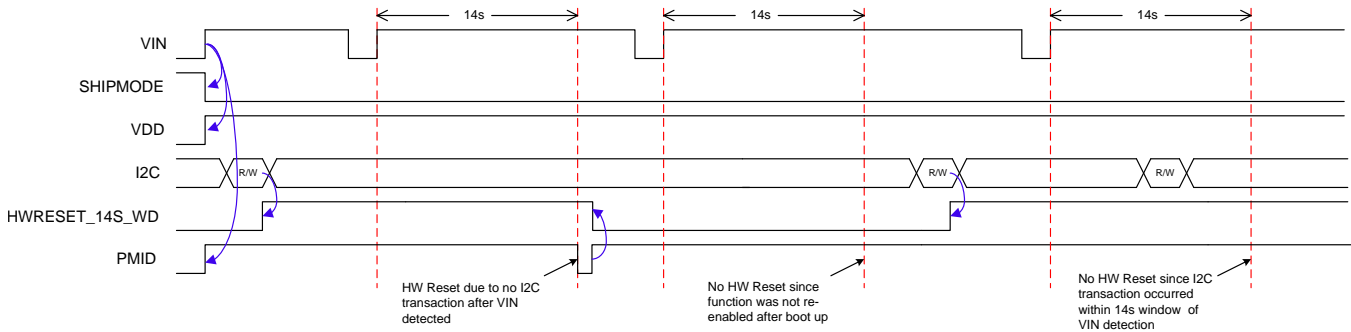

Figure 18. MR Wake and Reset Timing Active Mode When MR\_LPRESS\_ACTION = 1x (Ship Mode) and Only BAT is Present

### 8.3.8 14-second Watchdog for HW Reset

The BQ25150 integrates 14-second watchdog timer makes the BQ25150 to perform a HW reset/power cycle if no I<sup>2</sup>C transaction is detected within 14 seconds of a valid adapter being connected. If the adapter is connected and the host responds with an I<sup>2</sup>C transaction before the 14-second watchdog window expires, the part continues in normal operation. The 14-second watchdog is disabled by default may be enabled through I<sup>2</sup>C by setting the HWRESET\_14S\_WD bit. [Figure 19](#) shows the basic functionality of this feature.



**Figure 19. 14-second Watchdog for HW Reset Behavior**

### 8.3.9 Faults Conditions and Interrupts ( $\overline{\text{INT}}$ )

The device contains an open-drain output that signals an interrupt and is valid only after the device has completed start-up into a valid state. If the part starts into a fault, interrupts will not be sent. The  $\overline{\text{INT}}$  pin is normally in high impedance and is pulled low for 128us when an interrupt condition occurs. When a fault or status change occurs or any other condition that generates an interrupt such as ADC DATA READY, a 128us pulse (interrupt) is sent on  $\overline{\text{INT}}$  to notify the host. All interrupts may be masked through I<sup>2</sup>C. If the interrupt condition occurs while the interrupt is masked an interrupt pulse will not be sent. If the interrupt is unmasked while the fault condition is still present, an interrupt pulse will not be sent until the  $\overline{\text{INT}}$  trigger condition occurs while unmasked.

#### 8.3.9.1 Flags and Fault Condition Response

The table below details the BQ25150 behavior when a fault conditions occurs.

**Table 5. Interrupt Triggers and Fault Condition Response**

FAULT / FLAG	DESCRIPTION	INTERRUPT TRIGGER BASED ON STATUS BIT CHANGE	CHARGER BEHAVIOR	CHARGER SAFETY TIMER	LS/LDO BEHAVIOR	PMID BEHAVIOR	NOTES
CHRG_CV_FLAG	Set when charger enters Constant Voltage operation	Rising Edge	Enabled	No effect	N/A	IN powered if V <sub>IN</sub> is valid	
CHARGE_DONE_FLAG	Set when charger reaches termination	Rising Edge	Paused-Charging resumes with VIN or CE toggle or when V <sub>RCH</sub> is reached	Reset	N/A	IN powered if V <sub>IN</sub> is valid	
IINLIM_ACTIVE_FLAG	Set when Input Current Limit loop is active	Rising Edge	Enabled. Reduced charge current.	Doubled if option is enabled	N/A	IN powered VIN powered unless supplement mode condition is met.	
VDPPM_ACTIVE_FLAG	Set when DPPM loop is active	Rising Edge	Enabled. Reduced charge current.	Doubled if option is enabled	N/A	VIN powered unless supplement mode condition is met.	

**Table 5. Interrupt Triggers and Fault Condition Response (continued)**

FAULT / FLAG	DESCRIPTION	INTERRUPT TRIGGER BASED ON STATUS BIT CHANGE	CHARGER BEHAVIOR	CHARGER SAFETY TIMER	LS/LDO BEHAVIOR	PMID BEHAVIOR	NOTES
VINDPM_ACTIVE_FLAG	Set when VINDPM loop is active	Rising Edge	Enabled. Reduced charge current.	Doubled if option is enabled	N/A	VIN powered unless supplement mode condition is met.	
THERMREG_ACTIVE	Set when Thermal Charge Current Foldback (Thermal Regulation) loop is active	Rising Edge	Enabled. Reduced charge current.	Doubled if option is enabled	N/A	VIN powered unless supplement mode condition is met.	
VIN_PGOOD_FLAG	Set when VIN changes PGOOD status	Rising and Falling Edge	If VIN_PGOOD_S TAT is low, charging is disabled.	Reset	N/A	VIN powered (if VIN_PGOOD_S TAT=1) unless PMID_MODE is not 00.	Interrupt will not be sent if device powers up with VIN_PGOOD condition and $V_{BAT} < V_{BATUVLO}$
VIN_OVP_FAULT_FLAG	Set when $V_{IN} > V_{OVP}$	Rising Edge	Charging is paused until condition disappears	Reset	N/A	BAT powered	
BAT_OCP_FAULT_FLAG	Set when $I_{BAT} > I_{BATOC}$	Rising Edge	Disabled (BAT only condition)	N/A	N/A	Disconnect BAT	
BAT_UVLO_FAULT_FLAG	Set when $V_{BAT} < V_{BATUVLO}$	Rising Edge	Enabled	No effect	N/A	IN powered of $V_{IN}$ is valid	
TS_COLD_FLAG	Set when $V_{TS} > V_{TS\_COLD}$	Rising Edge	Charging paused until condition is cleared	Paused	N/A	IN powered of $V_{IN}$ is valid	
TS_COOL_FLAG	Set when $V_{TS\_COLD} > V_{TS} > V_{TS\_COOL}$	Rising Edge	Enabled. Reduced charge current.	Doubled if option is enabled	N/A	IN powered of $V_{IN}$ is valid	
TS_WARM_FLAG	Set when $V_{TS\_HOT} < V_{TS} < V_{TS\_WARM}$	Rising Edge	Enabled. Reduce battery regulation voltage.	No effect	N/A	IN powered of $V_{IN}$ is valid	
TS_HOT_FLAG	Set when $V_{TS} < V_{HOT}$	Rising Edge	Charging paused until condition is cleared	Paused	N/A	IN powered of $V_{IN}$ is valid	
ADC_READY_FLAG	Set when ADC conversion is completed	Rising Edge	N/A	N/A	N/A	N/A	
COMP1_ALARM_FLAG	Set when ADC measurement meets programmed condition	Rising Edge	N/A	N/A	N/A	N/A	
COMP2_ALARM_FLAG	Set when ADC measurement meets programmed condition	Rising Edge	N/A	N/A	N/A	N/A	
COMP3_ALARM_FLAG	Set when ADC measurement meets programmed condition	Rising Edge	N/A	N/A	N/A	N/A	

**Table 5. Interrupt Triggers and Fault Condition Response (continued)**

FAULT / FLAG	DESCRIPTION	INTERRUPT TRIGGER BASED ON STATUS BIT CHANGE	CHARGER BEHAVIOR	CHARGER SAFETY TIMER	LS/LDO BEHAVIOR	PMID BEHAVIOR	NOTES
IMAX_ACTIVE_FLAG	Set when charge current is programmed above the IMAX setting	Rising Edge	Enabled	N/A	N/A	N/A	
TS_OPEN_FLAG	Set when $V_{TS} > V_{TS\_OPEN}$	Rising Edge	Charging is paused until condition disappears	Paused	N/A	N/A	
WD_FAULT_FLAG	Set when I <sup>2</sup> C watchdog timer expires	Rising Edge	Enabled	N/A	N/A	N/A	
SAFETY_TMR_FAULT_FLAG	Set when safety Timer expires. Cleared after VIN or CE toggle	Rising Edge	Disabled until VIN or CE toggle	Reset after flag is cleared	N/A	IN powered of VIN is valid	
LS_LDO_OCP_FAULT_FLAG	Set when LDO output current exceeds OCP condition	Rising Edge	N/A	N/A	Enabled (host must take action to disable the LDO if desired)	N/A	
IMAX_FAULT_FLAG	Set when an open is detected on IMAX pin	Rising Edge	Chareg disabled until Power-On-Reset	N/A	N/A	N/A	
MRWAKE1_TIMEOUT_FLAG	Set when MR is low for at least $t_{WAKE1}$	Rising Edge	N/A	N/A	N/A	N/A	
MRWAKE2_TIMEOUT_FLAG	Set when MR is low for at least $t_{WAKE2}$	Rising Edge	N/A	N/A	N/A	N/A	
MRRESET_WARN_FLAG	Set when MR is low for at least $t_{RESETWARN}$	Rising Edge	N/A	N/A	N/A	N/A	
TSHUT	No flag. Die temperature exceeds thermal shutdown threshold is reached	N/A	Disabled	Disabled	Disabled	Disabled	

### 8.3.10 Power Good ( $\overline{PG}$ ) Pin

The  $\overline{PG}$  pin is an open-drain output that by default indicates when a valid IN supply is present. It may also be configured to be a general purpose output (GPO) controlled through I<sup>2</sup>C or to be a level shifted version of the MR input signal. Connect  $\overline{PG}$  to the desired logic voltage rail using a 1-kΩ to 100-kΩ resistor, or use with an LED for visual indication. Below is the description for each configuration:

- In its default state,  $\overline{PG}$  pulls to GND when the following conditions are met:  $V_{IN} > V_{UVLO}$ ,  $V_{IN} > V_{BAT} + V_{SLP}$  and  $V_{IN} < V_{IN\_OVP}$ .  $\overline{PG}$  is high impedance when the input power is not within specified limits.
- $\overline{MR}$  shifted (MRS) output when the  $\overline{PG\_MODE}$  bits are set to 01.  $\overline{PG}$  is high impedance when the  $\overline{MR}$  input is high, and  $\overline{PG}$  pulls to GND when the  $\overline{MR}$  input is low.
- General purpose open drain output when setting the  $\overline{PG\_MODE}$  bits to 1x. The state of the  $\overline{PG}$  pin is then controlled through the GPO\_PG bit, where if GPO\_PG is 0, the  $\overline{PG}$  pin is pulled to GND and if it is 1, the  $\overline{PG}$  pin is in high impedance.

### 8.3.11 External NTC Monitoring (TS)

The I<sup>2</sup>C interface allows the user to easily implement the JEITA standard for systems where the battery pack thermistor is monitored by the host. Additionally, the device provides a flexible voltage based TS input for monitoring the battery pack NTC thermistor. The voltage at TS is monitored to determine that the battery is at a safe temperature during charging.

The part can be configured to meet JEITA requirements or a simpler HOT/COLD function only. Additionally, the TS charger control function can be disabled. To satisfy the JEITA requirements, four temperature thresholds are monitored: the cold battery threshold, the cool battery threshold, the warm battery threshold, and the hot battery threshold. These temperatures correspond to the  $V_{COLD}$ ,  $V_{COOL}$ ,  $V_{WARM}$ , and  $V_{HOT}$  thresholds in the Electrical Characteristics table. Charging and safety timers are suspended when  $V_{TS} < V_{HOT}$  or  $V_{TS} > V_{COLD}$ . When  $V_{COOL} < V_{TS} < V_{COLD}$ , the charging current is reduced to the value programmed in the [TS\\_FASTCHGCTRL](#) register. Note that the current steps for fast charge in the COOL region, just as those in normal fast charge, are multiples of the fast charge LSB value (1.25mA by default). So in the case where the calculated scaled down current for the COOL region falls in between charge current steps, the device will round down the charge current to the nearest step. For example, if the fast charge current is set for 15mA (IC<sub>HG</sub> = 1100) and  $TS\_FASTCHARGE = 111$  (0.125\*IC<sub>HG</sub>), the charge current in the COOL region will be 1.25mA instead of the calculated 1.85mA.

When  $V_{HOT} < V_{TS} < V_{WARM}$ , the battery regulation voltage is reduced to the value programmed in the [TS\\_FASTCHGCTRL](#) register.

Regardless of whether the part is configured for JEITA, HOT/COLD, or disabled, when a TS fault occurs, a 128us pulse is sent on the INT output, and the FAULT bits of the register are updated over I<sup>2</sup>C. The FAULT bits are not cleared until they are read over I<sup>2</sup>C. This allows the host processor to take action if a different behavior than the pre-set function is needed. Alternately, the TS pin voltage can be read by the host if VIN is present or when BAT is present, so the appropriate action can be taken by the host.

#### 8.3.11.1 TS Thresholds

The BQ25150 monitors the TS voltage and sends an interrupt to the host whenever it crosses the  $V_{HOT}$ ,  $V_{WARM}$ ,  $V_{COOL}$  and  $V_{COLD}$  thresholds which correspond to different temperature thresholds based on the NTC resistance and biasing. These thresholds may be adjusted through I<sup>2</sup>C by the host. The device will also disable charging if TS pin exceeds the  $V_{TS\_OPEN}$  threshold.

The TS biasing circuit is shown in [Figure 20](#). The ADC range is set to 1.2 V. Note that the respective  $V_{TS}$  and hence ADC reading for  $T_{COLD}$  (0°C),  $T_{COOL}$  (10°C),  $T_{WARM}$  (45°C) and  $T_{HOT}$  (60°C) changes for every NTC, therefore the threshold values may need to be adjusted through I<sup>2</sup>C based on the supported NTC type.

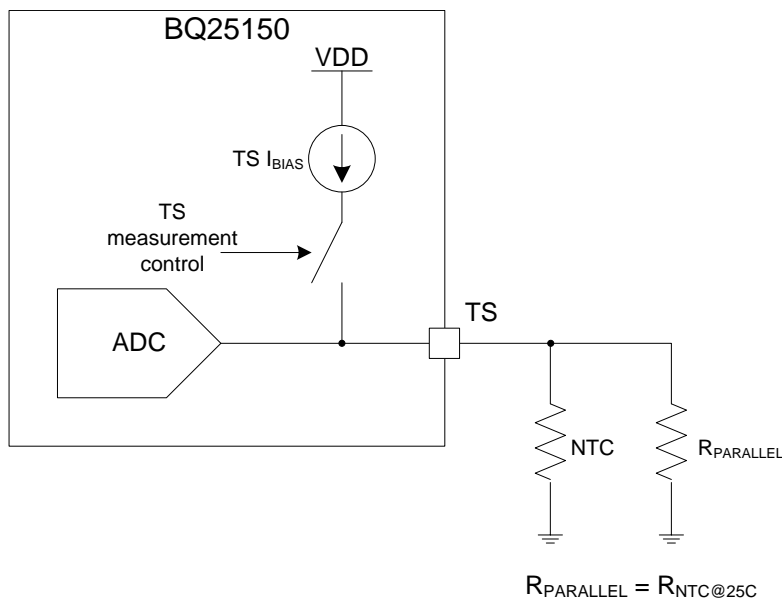

Figure 20. TS Bias Functional Diagram

The BQ25150 supports by default the following thresholds for a 10K $\Omega$  NTC

**Table 6. TS Thresholds for 10K Thermistor**

THRESHOLD	TEMPERATURE (°C)	VTS (V)
Open	--	>0.9
Cold	0	0.585
Cool	10	0.514
Warm	45	0.265
Hot	60	0.185

For accurate temperature thresholds a 10K NTC with a 3380 B-constant should be used (Murata NCP03XH103F05RL for example) with a parallel 10K resistor. Each threshold can be programmed via I<sup>2</sup>C through the TS\_COLD, TS\_COOL, TS\_WARM and TS\_HOT registers. The value in the registers corresponds to the 8 MSBs in the TS ADC output code.

### 8.3.12 External NTC Monitoring (ADCIN)

The ADCIN pin can be configured through I<sup>2</sup>C to support NTC measurements without the need of an external biasing circuit. In this mode, the ADCIN pin is biased and monitored in the same manner as the TS pin. Measurement data can be read by selecting one of the ADC data slots to read the ADCIN.

### 8.3.13 I<sup>2</sup>C Interface

The BQ25150 device uses a fully compliant I<sup>2</sup>C interface to program and read control parameters, status bits, etc. I<sup>2</sup>C™ is a 2-wire serial interface developed by Philips Semiconductor (see I<sup>2</sup>C-Bus Specification, Version 2.1, January 2000). The bus consists of a data line (SDA) and a clock line (SCL) with pull-up structures. When the bus is idle, both SDA and SCL lines are pulled high. All the I<sup>2</sup>C compatible devices connect to the I<sup>2</sup>C bus through open drain I/O pins, SDA and SCL. A master device, usually a microcontroller or a digital signal processor, controls the bus. The master is responsible for generating the SCL signal and device addresses. The master also generates specific conditions that indicate the START and STOP of data transfer. A slave device receives and/or transmits data on the bus under control of the master device.

BQ25150 works as a slave and supports the following data transfer modes, as defined in the I<sup>2</sup>C Bus™ Specification: standard mode (100 kbps) and fast mode (400 kbps). The interface adds flexibility to the battery charge solution, enabling most functions to be programmed to new values depending on the instantaneous application requirements.

Register contents remain intact as long as VBAT or VIN voltages remains above their respective UVLO levels.

The data transfer protocol for standard and fast modes is exactly the same; therefore, they are referred to as the F/S-mode in this document. The BQ25150 device 7-bit address is 0x6B (shifted 8-bit address is 0xD6).

#### 8.3.13.1 F/S Mode Protocol

The master initiates data transfer by generating a start condition. The start condition is when a high-to-low transition occurs on the SDA line while SCL is high, as shown in Figure 21. All I<sup>2</sup>C-compatible devices should recognize a start condition.

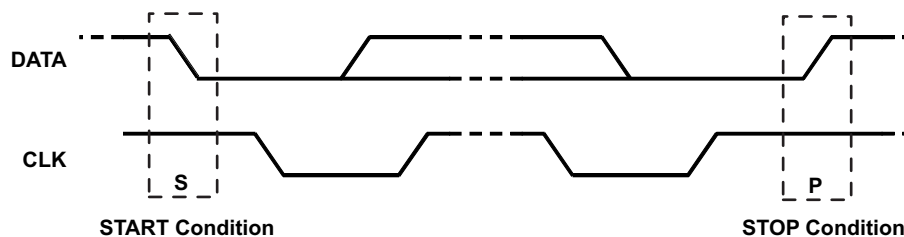

**Figure 21. START and STOP Condition**

The master then generates the SCL pulses, and transmits the 8-bit address and the read/write direction bit R/W on the SDA line. During all transmissions, the master ensures that data is valid. A valid data condition requires the SDA line to be stable during the entire high period of the clock pulse (see Figure 22). All devices recognize the address sent by the master and compare it to their internal fixed addresses. Only the slave device with a matching address generates an acknowledge (see Figure 23) by pulling the SDA line low during the entire high period of the ninth SCL cycle. Upon detecting this acknowledge, the master knows that communication link with a slave has been established.

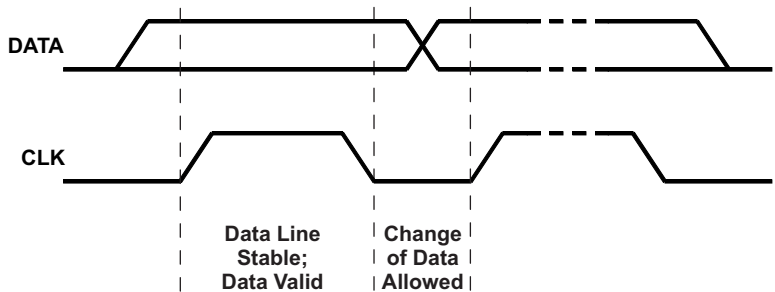

Figure 22. Bit Transfer on the Serial Interface

The master generates further SCL cycles to either transmit data to the slave (R/W bit 1) or receive data from the slave (R/W bit 0). In either case, the receiver needs to acknowledge the data sent by the transmitter. So an acknowledge signal can either be generated by the master or by the slave, depending on which one is the receiver. The 9-bit valid data sequences consisting of 8-bit data and 1-bit acknowledge can continue as long as necessary. To signal the end of the data transfer, the master generates a stop condition by pulling the SDA line from low to high while the SCL line is high (see Figure 21). This releases the bus and stops the communication link with the addressed slave. All I<sup>2</sup>C compatible devices must recognize the stop condition. Upon the receipt of a stop condition, all devices know that the bus is released, and wait for a start condition followed by a matching address. If a transaction is terminated prematurely, the master needs to send a STOP condition to prevent the slave I<sup>2</sup>C logic from remaining in an incorrect state. Attempting to read data from register addresses not listed in this section will result in FFh being read out.

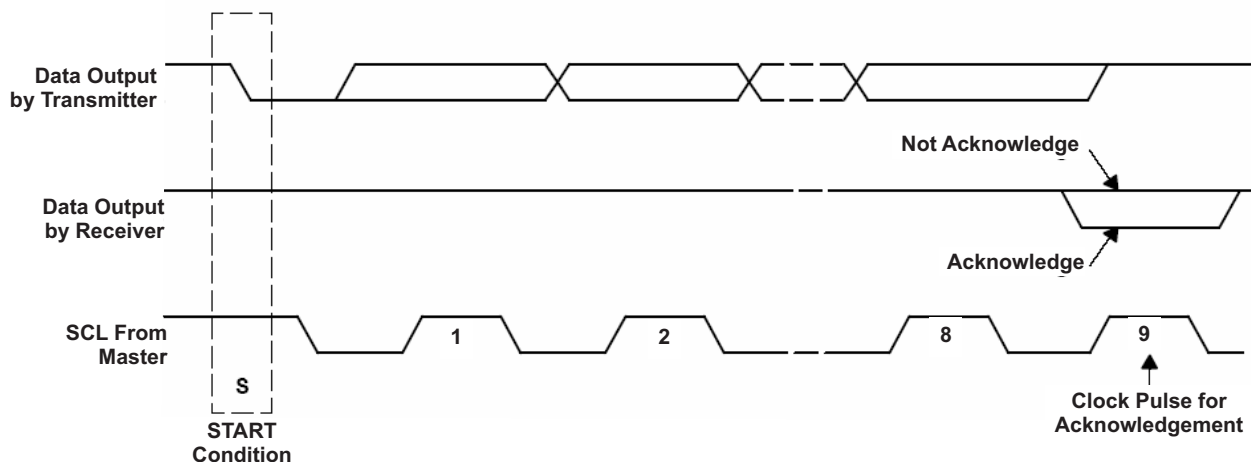
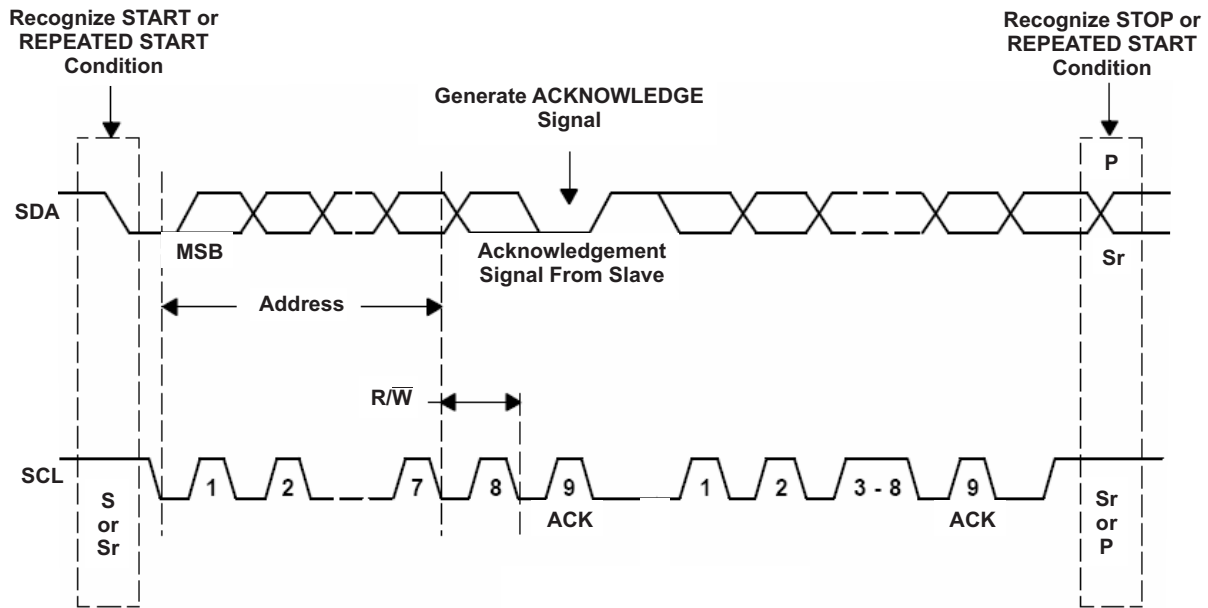

Figure 23. Acknowledge on the I<sup>2</sup>C Bus



**Figure 24. Bus Protocol**



## 8.4 Device Functional Modes

BQ25150 has four main modes of operation: Active Battery Mode, Low Power Mode and Ship Mode which are battery only modes and Charge/Adapter Mode when a supply is connected to IN. The table below summarizes the functions that are active for each operation mode. Each mode is discussed in further detail in the following sections in addition to the device's power-up/down sequences.

**Table 7. Function Availability Based on Primary Mode of Operation**

FUNCTION	CHARGE/ ADAPTER MODE	SHIP MODE	LOW POWER MODE	ACTIVE BATTERY MODE
VOVP	Yes	No	Yes	Yes
VUVLO	Yes	Yes	Yes	Yes
BATOCP	Yes	No	No	Yes
BATUVLO	Yes	No	Yes	Yes
VINDPM	If enabled	No	No	No
DPPM	If enabled	No	No	No
VDD	Yes	No	Yes	Yes
LS/LDO	Yes	No	If enabled	If enabled
BATFET	Yes	No	Yes	Yes
TS Measurement	Yes	No	No	If enabled
Battery Changing	If enabled	No	No	No
ILIM	Yes (Register Value)	No	No	No
$\overline{\text{MR}}$ input	Yes	Yes	Yes	Yes
$\overline{\text{LP}}$ input	No	No	Yes	Yes
$\overline{\text{INT}}$ output	Yes	No	No	Yes
I <sup>2</sup> C	Yes	No	No	Yes
$\overline{\text{CE}}$ input	Yes	No	No	No
ADC	Yes	No	No	Yes

### 8.4.1 Ship Mode

Ship Mode is the lowest quiescent current state for the device. Ship Mode latches off the device and BAT FET until  $V_{\text{IN}} > V_{\text{UVLO}}$  or the  $\overline{\text{MR}}$  button is depressed for  $t_{\text{WAKE2}}$  and released. Ship mode can be entered regardless of the state of  $\overline{\text{CE}}$ . The device will also enter Ship Mode upon battery insertion when no valid  $V_{\text{IN}}$  is present. If the  $\text{EN\_SHIPMODE}$  is written to a 1 while a valid input supply is connected, the device will wait until the IN supply is removed to enter ship mode. If the  $\overline{\text{MR}}$  pin is held low when the  $\text{EN\_SHIPMODE}$  bit is set, the device will wait until the  $\overline{\text{MR}}$  pin goes high before entering Ship Mode. [Figure 25](#) shows this behavior. The battery voltage must be above the maximum programmable  $V_{\text{BATUVLO}}$  threshold in order to exit Ship Mode with  $\overline{\text{MR}}$  press. The  $\text{EN\_SHIPMODE}$  bit can be cleared using the I<sup>2</sup>C interface as well while the  $V_{\text{IN}}$  input is valid. The  $\text{EN\_SHIPMODE}$  bit is not cleared upon the I<sup>2</sup>C watchdog expiring, this means that if watchdog timer fault occurs while the  $\text{EN\_SHIPMODE}$  bit is set and the device is waiting to go into Ship Mode because  $V_{\text{IN}}$  is present or  $\overline{\text{MR}}$  is low, the device will still proceed to go into Ship Mode once those conditions are cleared. The following list shows the functions that are active during Ship Mode:

- $V_{\text{IN\_UVLO}}$  Comparator
- $\overline{\text{MR}}$  Input

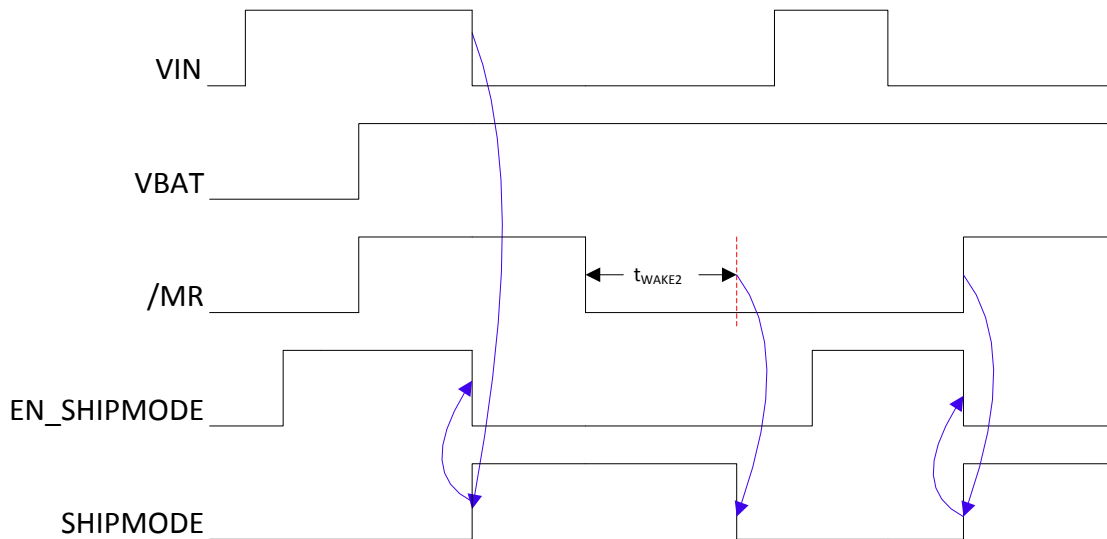

**Figure 25. Ship Mode Entry Based On EN\_SHIPMODE bit**

#### 8.4.2 Low Power

Low Power mode is a low quiescent current state while operating from the battery. The device will operate in low power mode when the  $\overline{LP}$  pin is set low,  $V_{IN} < V_{UVLO}$ ,  $\overline{MR}$  pin is high and all I<sup>2</sup>C transactions and interrupts that started while in the Active Battery or Charging Modes have been completed and sent. During LP mode the VDD output is powered by BAT, the MR inputs are active and the I<sup>2</sup>C and ADC are disabled. All other circuits, such as oscillators, are in a low power or off state. The LS/LDO outputs will remain in the state set by the EN\_LS\_LDO bit prior to entering Low Power Mode. The device exits LP Mode when the  $\overline{LP}$  pin is set high or  $V_{IN} > V_{UVLO}$ .

In the case that a faulty adapter with  $V_{IN} > V_{OVP}$  is connected to the device while  $\overline{LP}$  pin is low, the device will be powered from the battery, but will operate in Active battery mode instead of Low Power mode regardless of the  $\overline{LP}$  pin state.

When  $\overline{MR}$  is held low while  $\overline{LP}$  is low, the device will enter Active Battery Mode, this allows for the internal clocks of the device to be running and allow the  $\overline{MR}$  long button press HW reset. I<sup>2</sup>C operation may also be possible during this condition. Note that as soon as the  $\overline{MR}$  input is released and goes high, the device will go back to LP Mode tuning off all clocks. Note that if a HW reset has occurred while  $\overline{LP}$  is low,  $\overline{MR}$  must remain low until the power cycle has completed (PMID and LDO enable) to allow completion of the power up sequence.

#### 8.4.3 Active Battery

When the device is out of Ship Mode and battery is above  $V_{BATUVLO}$  with no valid input source, the battery discharge FET is turned on connecting PMID to the battery. The current flowing from BAT to PMID is not regulated, but it is monitored by the battery over-current protection (OCP) circuitry. If the battery discharge current exceed the OCP threshold, the battery discharge FET will be turned off as detailed in [Battery Short and Over Current Protection](#)

If only battery is connected and the battery voltage goes below  $V_{BATUVLO}$ , the battery discharge FET is turned off. To provide designers the most flexibility in optimizing their system, an adjustable BATUVLO is provided. Deeper discharge of the battery enables longer times between charging, but may shorten the battery life. The BATUVLO is adjustable with a fixed 150mV hysteresis.

#### 8.4.4 Charger/Adapter Mode

This mode is active when  $V_{IN} > V_{UVLO}$ . In this mode the ADC is enabled and continuously running conversions on all channels. If the supply at IN is valid and above the  $V_{IN\_DPM}$  level, PMID will be powered by the supply connected to IN. The device will charge the battery, if charging is enabled, until termination has occurred.

### 8.4.5 Power-Up/Down Sequencing

The power-up and power-down sequences for the BQ25150 are shown below. Upon  $V_{IN}$  insertion,  $V_{IN} > V_{UVLO}$ , the device wakes up, powering the VDD rail. If  $V_{IN} > V_{BAT} + V_{SLP}$  and  $V_{IN} < V_{OVP}$ , PMID will be powered by  $V_{IN}$  and if  $V_{IN} > V_{IN\_DPM}$  charging will start if enabled.

In the case where  $V_{IN} < V_{UVLO}$  and the battery is inserted ( $V_{BAT} > V_{BATUVLO}$ ), the device will immediately enter Ship Mode unless  $\overline{MR}$  is held low. Upon battery insertion the VDD rail will come up to allow the device to check the  $\overline{MR}$  state and if  $\overline{MR}$  is high VDD will immediately be disabled and the device will enter Ship Mode. If  $\overline{MR}$  is low, the device will start the WAKE timer and power up PMID and other rails if  $\overline{MR}$  is held low for longer than  $t_{WAKE2}$ .

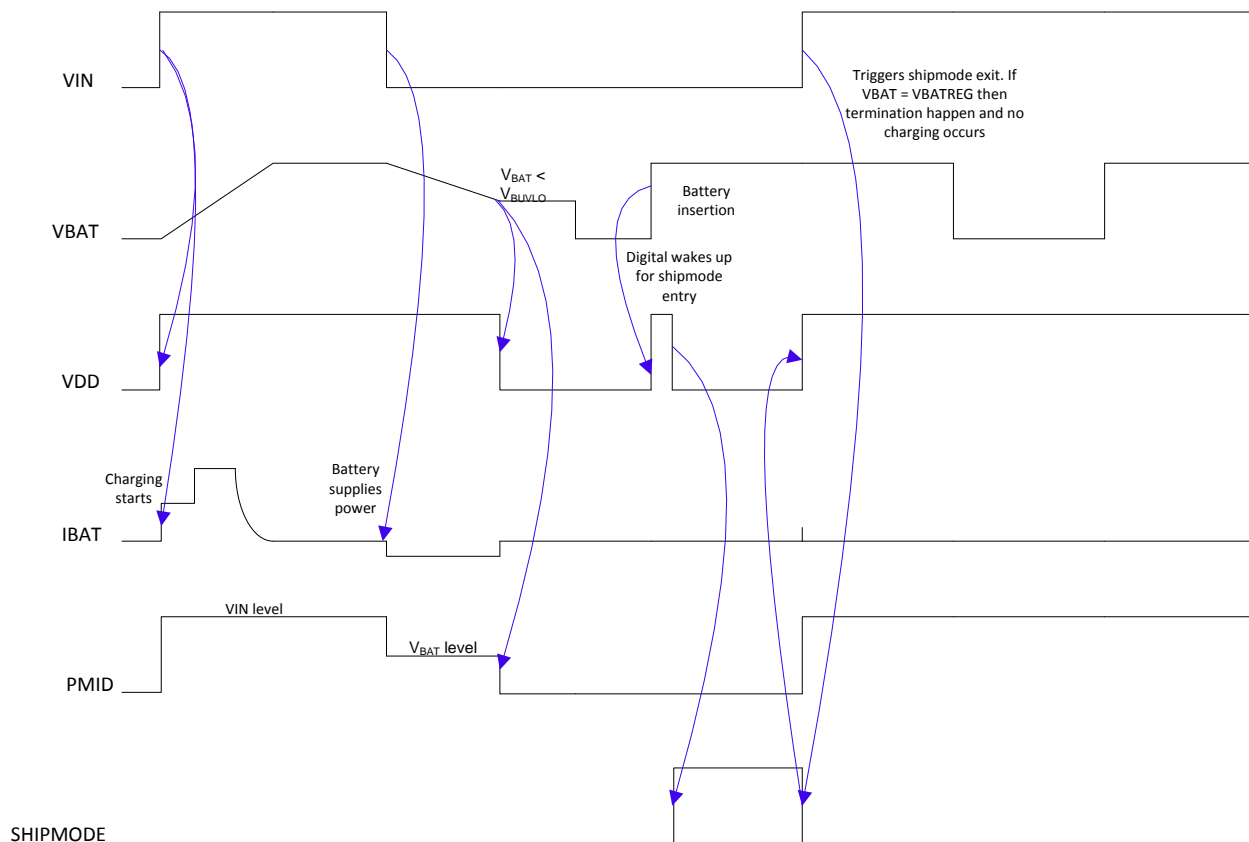
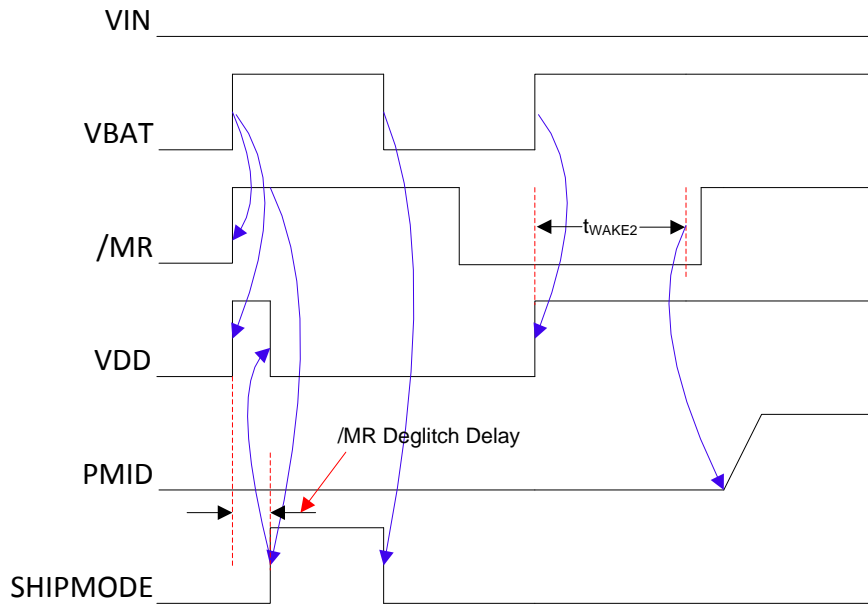

Figure 26. BQ25150 Wake-Up Upon Supply Insertion



**Figure 27. BQ25150 Wake-Up Upon Battery Insertion**

## 8.5 Register Map

Device 7-bit address I<sup>2</sup>C is 0x6B (shifted 8-bit address is 0xD6).

### 8.5.1 I2C Registers

Table 8 lists the memory-mapped registers for the I2C registers. All register offset addresses not listed in Table 8 should be considered as reserved locations and the register contents should not be modified.

**Table 8. I2C Registers**

Address	Acronym	Register Name	Section
0x0	STAT0	Charger Status 0	<a href="#">Go</a>
0x1	STAT1	Charger Status 1	<a href="#">Go</a>
0x2	STAT2	ADC Status	<a href="#">Go</a>
0x3	FLAG0	Charger Flags 0	<a href="#">Go</a>
0x4	FLAG1	Charger Flags 1	<a href="#">Go</a>
0x5	FLAG2	ADC Flags	<a href="#">Go</a>
0x6	FLAG3	Timer Flags	<a href="#">Go</a>
0x7	MASK0	Interrupt Masks 0	<a href="#">Go</a>
0x8	MASK1	Interrupt Masks 1	<a href="#">Go</a>
0x9	MASK2	Interrupt Masks 2	<a href="#">Go</a>
0xA	MASK3	Interrupt Masks 3	<a href="#">Go</a>
0x12	VBAT_CTRL	Battery Voltage Control	<a href="#">Go</a>
0x13	ICHG_CTRL	Fast Charge Current Control	<a href="#">Go</a>
0x14	PCHRGCTRL	Pre-Charge Current Control	<a href="#">Go</a>
0x15	TERMCTRL	Termination Current Control	<a href="#">Go</a>
0x16	BUVLO	Battery UVLO and Current Limit Control	<a href="#">Go</a>
0x17	CHARGERCTRL0	Charger Control 0	<a href="#">Go</a>
0x18	CHARGERCTRL1	Charger Control 1	<a href="#">Go</a>
0x19	ILIMCTRL	Input Current Limit Control	<a href="#">Go</a>
0x1D	LDOCTRL	LDO Control	<a href="#">Go</a>
0x30	MRCTRL	MR Control	<a href="#">Go</a>
0x35	ICCTRL0	IC Control 0	<a href="#">Go</a>
0x36	ICCTRL1	IC Control 1	<a href="#">Go</a>
0x37	ICCTRL2	IC Control 2	<a href="#">Go</a>
0x40	ADCCTRL0	ADC Control 0	<a href="#">Go</a>
0x41	ADCCTRL1	ADC Control 1	<a href="#">Go</a>
0x42	ADC_DATA_VBAT_M	ADC VBAT Measurement MSB	<a href="#">Go</a>
0x43	ADC_DATA_VBAT_L	ADC VBAT Measurement LSB	<a href="#">Go</a>
0x44	ADC_DATA_TS_M	ADC TS Measurement MSB	<a href="#">Go</a>
0x45	ADC_DATA_TS_L	ADC TS Measurement LSB	<a href="#">Go</a>
0x46	ADC_DATA_ICHG_M	ADC ICHG Measurement MSB	<a href="#">Go</a>
0x47	ADC_DATA_ICHG_L	ADC ICHG Measurement LSB	<a href="#">Go</a>
0x48	ADC_DATA_ADCIN_M	ADC ADCIN Measurement MSB	<a href="#">Go</a>
0x49	ADC_DATA_ADCIN_L	ADC ADCIN Measurement LSB	<a href="#">Go</a>
0x4A	ADC_DATA_VIN_M	ADC VIN Measurement MSB	<a href="#">Go</a>
0x4B	ADC_DATA_VIN_L	ADC VIN Measurement LSB	<a href="#">Go</a>
0x4C	ADC_DATA_P MID_M	ADC VPMID Measurement MSB	<a href="#">Go</a>
0x4D	ADC_DATA_P MID_L	ADC VPMID Measurement LSB	<a href="#">Go</a>
0x4E	ADC_DATA_IIN_M	ADC IIN Measurement MSB	<a href="#">Go</a>
0x4F	ADC_DATA_IIN_L	ADC IIN Measurement LSB	<a href="#">Go</a>
0x52	ADCALARM_COMP1_M	ADC Comparator 1 Threshold MSB	<a href="#">Go</a>

**Table 8. I2C Registers (continued)**

Address	Acronym	Register Name	Section
0x53	ADCALARM_COMP1_L	ADC Comparator 1 Threshold LSB	<a href="#">Go</a>
0x54	ADCALARM_COMP2_M	ADC Comparator 2 Threshold MSB	<a href="#">Go</a>
0x55	ADCALARM_COMP2_L	ADC Comparator 2 Threshold LSB	<a href="#">Go</a>
0x56	ADCALARM_COMP3_M	ADC Comparator 3 Threshold MSB	<a href="#">Go</a>
0x57	ADCALARM_COMP3_L	ADC Comparator 3 Threshold LSB	<a href="#">Go</a>
0x58	ADC_READ_EN	ADC Channel Enable	<a href="#">Go</a>
0x61	TS_FASTCHGCTRL	TS Charge Control	<a href="#">Go</a>
0x62	TS_COLD	TS Cold Threshold	<a href="#">Go</a>
0x63	TS_COOL	TS Cool Threshold	<a href="#">Go</a>
0x64	TS_WARM	TS Warm Threshold	<a href="#">Go</a>
0x65	TS_HOT	TS Hot Threshold	<a href="#">Go</a>
0x6F	DEVICE_ID	Device ID	<a href="#">Go</a>

Complex bit access types are encoded to fit into small table cells. [Table 9](#) shows the codes that are used for access types in this section.

**Table 9. I2C Access Type Codes**

Access Type	Code	Description
<b>Read Type</b>		
R	R	Read
RC	C R	to Clear Read
<b>Write Type</b>		
W	W	Write
<b>Reset or Default Value</b>		
-n		Value after reset or the default value

### 8.5.1.1 STAT0 Register (Address = 0x0) [reset = X]

STAT0 is shown in [Figure 28](#) and described in [Table 10](#).

Return to [Summary Table](#).

**Figure 28. STAT0 Register**

7	6	5	4	3	2	1	0
RESERVED	CHRG_CV_STAT	CHARGE_DONE_STAT	IINLIM_ACTIVE_STAT	VDPPM_ACTIVE_STAT	VINDPM_ACTIVE_STAT	THERMREG_ACTIVE_STAT	VIN_PGOOD_STAT
R-X	R-X	R-X	R-X	R-X	R-X	R-X	R-X

**Table 10. STAT0 Register Field Descriptions**

Bit	Field	Type	Reset	Description
7	RESERVED	R	X	Reserved
6	CHRG_CV_STAT	R	X	Constant Voltage Charging Mode (Taper Mode) Status 1b0 = Not Active 1b1 = Active
5	CHARGE_DONE_STAT	R	X	Charge Done Status 1b0 = Not Active 1b1 = Active
4	IINLIM_ACTIVE_STAT	R	X	Input Current Limit Status 1b0 = Not Active 1b1 = Active
3	VDPPM_ACTIVE_STAT	R	X	DPPM Status 1b0 = Not Active 1b1 = Active
2	VINDPM_ACTIVE_STAT	R	X	VINDPM Status 1b0 = Not Active 1b1 = Active
1	THERMREG_ACTIVE_STAT	R	X	Thermal Regulation Status 1b0 = Not Active 1b1 = Active
0	VIN_PGOOD_STAT	R	X	VIN Power Good Status 1b0 = Not Good 1b1 = $V_{IN} > V_{UVLO}$ and $V_{IN} > V_{BAT} + V_{SLP}$ and $V_{IN} < V_{OVP}$

**8.5.1.2 STAT1 Register (Address = 0x1) [reset = X]**

 STAT1 is shown in [Figure 29](#) and described in [Table 11](#).

 Return to [Summary Table](#).

**Figure 29. STAT1 Register**

7	6	5	4	3	2	1	0
VIN_OVP_FAULT_STAT	RESERVED	BAT_OCP_FAULT_STAT	BAT_UVLO_FAULT_STAT	TS_COLD_STAT	TS_COOL_STAT	TS_WARM_STAT	TS_HOT_STAT
R-X	R-X	R-X	R-X	R-X	R-X	R-X	R-X

**Table 11. STAT1 Register Field Descriptions**

Bit	Field	Type	Reset	Description
7	VIN_OVP_FAULT_STAT	R	X	VIN Overvoltage Status 1b0 = Not Active 1b1 = Active
6	RESERVED	R	X	Reserved
5	BAT_OCP_FAULT_STAT	R	X	Battery Over-Current Protection Status 1b0 = Not Active 1b1 = Active
4	BAT_UVLO_FAULT_STAT	R	X	Battery voltage below BATUVLO Level Status 1b0 = $V_{BAT} > V_{BATUVLO}$ 1b1 = $V_{BAT} < V_{BATUVLO}$
3	TS_COLD_STAT	R	X	TS Cold Status - $V_{TS} > V_{COLD}$ (Charging suspended) 1b0 = Not Active 1b1 = Active
2	TS_COOL_STAT	R	X	TS Cool Status - $V_{COOL} < V_{TS} < V_{COLD}$ (Charging current reduced by value set by TS_Registers) 1b0 = Not Active 1b1 = Active
1	TS_WARM_STAT	R	X	TS Warm - $V_{WARM} > V_{TS} > V_{HOT}$ (Charging voltage reduced by value set by TS_Registers) 1b0 = Not Active 1b1 = Active
0	TS_HOT_STAT	R	X	TS Hot Status - $V_{TS} < V_{HOT}$ (charging suspended) 1b0 = Not Active 1b1 = Active



### 8.5.1.3 STAT2 Register (Address = 0x2) [reset = X]

STAT2 is shown in Figure 30 and described in Table 12.

Return to [Summary Table](#).

**Figure 30. STAT2 Register**

7	6	5	4	3	2	1	0
RESERVED	COMP1_ALAR M_STAT	COMP2_ALAR M_STAT	COMP3_ALAR M_STAT	RESERVED			TS_OPEN_ST AT
R-X	R-X	R-X	R-X	R-X			R-X

**Table 12. STAT2 Register Field Descriptions**

Bit	Field	Type	Reset	Description
7	RESERVED	R	X	Reserved
6	COMP1_ALARM_STAT	R	X	COMP1 Status 1b0 = Selected ADC measurement does not meet condition set by 1_ADCALARM_ABOVE bit 1b1 = Selected ADC measurement meets condition set by 1_ADCALARM_ABOVE bit
5	COMP2_ALARM_STAT	R	X	COMP2 Status 1b0 = Selected ADC measurement does not meet condition set by 2_ADCALARM_ABOVE bit 1b1 = Selected ADC measurement meets condition set by 2_ADCALARM_ABOVE bit
4	COMP3_ALARM_STAT	R	X	COMP3 Status 1b0 = Selected ADC measurement does not meet condition set by 1_ADCALARM_ABOVE bit 1b1 = Selected ADC measurement meets condition set by 2_ADCALARM_ABOVE bit
3-1	RESERVED	R	X	Reserved
0	TS_OPEN_STAT	R	X	TS Open Status 1b0 = $V_{TS} < V_{OPEN}$ 1b1 = $V_{TS} > V_{OPEN}$

**8.5.1.4 FLAG0 Register (Address = 0x3) [reset = 0x0]**

FLAG0 is shown in [Figure 31](#) and described in [Table 13](#).

Return to [Summary Table](#).

Clear on Read

**Figure 31. FLAG0 Register**

7	6	5	4	3	2	1	0
RESERVED	CHRG_CV_FL AG	CHARGE_DON E_FLAG	IINLIM_ACTIVE _FLAG	VDPPM_ACTIV E_FLAG	VINDPM_ACTI VE_FLAG	THERMREG_A CTIVE_FLAG	VIN_PGOOD_F LAG
RC-1b0	RC-1b0	RC-1b0	RC-1b0	RC-1b0	RC-1b0	RC-1b0	RC-1b0

**Table 13. FLAG0 Register Field Descriptions**

Bit	Field	Type	Reset	Description
7	RESERVED	RC	1b0	Reserved
6	CHRG_CV_FLAG	RC	1b0	Constant Voltage Charging Mode (Taper Mode) Flag 1b0 = CV Mode Entry not detected 1b1 = CV Mode Entry detected
5	CHARGE_DONE_FLAG	RC	1b0	Charge Done Flag 1b0 = Charge Done (Termination) not detected 1b1 = Charge Done (Termination) detected
4	IINLIM_ACTIVE_FLAG	RC	1b0	Input Current Limit Flag 1b0 = Input Current Limit not detected 1b1 = Input Current Limit detected
3	VDPPM_ACTIVE_FLAG	RC	1b0	DPPM Flag 1b0 = DPPM operation not detected 1b1 = DPPM operation detected
2	VINDPM_ACTIVE_FLAG	RC	1b0	VINDPM Flag 1b0 = VINDPM operation not detected 1b1 = VIINDPM operation detected
1	THERMREG_ACTIVE_FL AG	RC	1b0	Thermal Regulation Flag 1b0 = Thermal Regulation not detected 1b1 = Thermal Regulation detected
0	VIN_PGOOD_FLAG	RC	1b0	VIN Power Good Flag 1b0 = No change in VIN Power Good Status 1b1 = Change in VIN Power Good Status detected.

### 8.5.1.5 FLAG1 Register (Address = 0x4) [reset = 0x0]

FLAG1 is shown in [Figure 32](#) and described in [Table 14](#).

Return to [Summary Table](#).

Clear on Read

**Figure 32. FLAG1 Register**

7	6	5	4	3	2	1	0
VIN_OVP_FAULT_FLAG	RESERVED	BAT_OCP_FAULT_FLAG	BAT_UVLO_FAULT_FLAG	TS_COLD_FLAG	TS_COOL_FLAG	TS_WARM_FLAG	TS_HOT_FLAG
RC-1b0	RC-1b0	RC-1b0	RC-1b0	RC-1b0	RC-1b0	RC-1b0	RC-1b0

**Table 14. FLAG1 Register Field Descriptions**

Bit	Field	Type	Reset	Description
7	VIN_OVP_FAULT_FLAG	RC	1b0	VIN Over Voltage Fault Flag 1b0 = No overvoltage condition detected 1b1 = VIN overvoltage condition detected
6	RESERVED	RC	1b0	Reserved
5	BAT_OCP_FAULT_FLAG	RC	1b0	Battery Over Current Protection Flag 1b0 = No Battery Over Current condition detected 1b1 = Battery Over Current condition detected
4	BAT_UVLO_FAULT_FLAG	RC	1b0	Battery Under Voltage Flag 1b0 = Battery below BATUVLO condition detected 1b1 = No Battery below BATUVLO condition detected
3	TS_COLD_FLAG	RC	1b0	TS Cold Region Entry Flag 1b0 = TS Cold Region Entry not detected 1b1 = TS Cold Region Entry detected
2	TS_COOL_FLAG	RC	1b0	TS Cool Region Entry Flag 1b0 = TS Cool Region Entry not detected 1b1 = TS Cool Region Entry detected
1	TS_WARM_FLAG	RC	1b0	TS Warm Region Entry Flag 1b0 = TS Warm Region Entry not detected 1b1 = TS Warm Region Entry detected
0	TS_HOT_FLAG	RC	1b0	TS Hot Region Entry Flag 1b0 = TS Hot Region Entry not detected 1b1 = TS Hot Region Entry detected

**8.5.1.6 FLAG2 Register (Address = 0x5) [reset = 0x0]**

 FLAG2 is shown in [Figure 33](#) and described in [Table 15](#).

 Return to [Summary Table](#).

Clear on Read

**Figure 33. FLAG2 Register**

7	6	5	4	3	2	1	0
ADC_READY_FLAG	COMP1_ALARM_FLAG	COMP2_ALARM_FLAG	COMP3_ALARM_FLAG	RESERVED			TS_OPEN_FLAG
RC-1b0	RC-1b0	RC-1b0	RC-1b0	RC-3b000			RC-1b0

**Table 15. FLAG2 Register Field Descriptions**

Bit	Field	Type	Reset	Description
7	ADC_READY_FLAG	RC	1b0	ADC Ready Flag 1b0 = No ADC conversion completed since last flag read 1b1 = ADC Conversion Completed
6	COMP1_ALARM_FLAG	RC	1b0	ADC COMP1 Threshold Flag 1b0 = No threshold crossing detected 1b1 = Selected ADC measurement crossed condition set by 1_ADCALARM_ABOVE bit
5	COMP2_ALARM_FLAG	RC	1b0	ADC COMP2 Threshold Flag 1b0 = No threshold crossing detected 1b1 = Selected ADC measurement crossed condition set by 2_ADCALARM_ABOVE bit
4	COMP3_ALARM_FLAG	RC	1b0	ADC COMP3 Threshold Flag 1b0 = No threshold crossing detected 1b1 = Selected ADC measurement crossed condition set by 3_ADCALARM_ABOVE bit
3-1	RESERVED	RC	3b000	Reserved
0	TS_OPEN_FLAG	RC	1b0	TS Open Flag 1b0 = No TS Open fault detected 1b1 = TS Open fault detected

### 8.5.1.7 FLAG3 Register (Address = 0x6) [reset = 0x0]

FLAG3 is shown in [Figure 34](#) and described in [Table 16](#).

Return to [Summary Table](#).

Clear on Read

**Figure 34. FLAG3 Register**

7	6	5	4	3	2	1	0
RESERVED	WD_FAULT_FL AG	SAFETY_TMR _FAULT_FLAG	LDO_OCP_FA ULT_FLAG	IMAX_FAULT_ FLAG	MRWAKE1_TI MEOUT_FLAG	MRWAKE2_TI MEOUT_FLAG	MRRESET_WA RN_FLAG
RC-1b0	RC-1b0	RC-1b0	RC-1b0	RC-1b0	RC-1b0	RC-1b0	RC-1b0

**Table 16. FLAG3 Register Field Descriptions**

Bit	Field	Type	Reset	Description
7	RESERVED	RC	1b0	Reserved
6	WD_FAULT_FLAG	RC	1b0	Watchdog Fault Flag 1b0 = Watchdog Timer not expired 1b1 = Watchdog Timer expired
5	SAFETY_TMR_FAULT_F LAG	RC	1b0	Safety Timer Fault Flag 1b0 = Safety Timer not expired 1b1 = Safety Timer Expired
4	LDO_OCP_FAULT_FLAG	RC	1b0	LDO Over Current Fault 1b0 = LDO Normal 1b1 = LDO Over current fault detected
3	IMAX_FAULT_FLAG	RC	1b0	IMAX Open Fault Flag 1b0 = No IMAX open fault detected 1b1 = IMAX open fault detected
2	MRWAKE1_TIMEOUT_FL AG	RC	1b0	MR Wake 1 Timer Flag 1b0 = MR Wake 1 timer not expired 1b1 = MR Wake 1 timer expired
1	MRWAKE2_TIMEOUT_FL AG	RC	1b0	MR Wake 2 Timer Flag 1b0 = MR Wake 2 timer not expired 1b1 = MR Wake 2 timer expired
0	MRRESET_WARN_FLAG	RC	1b0	MR Reset Warn Timer Flag 1b0 = MR Reset Warn timer not expired 1b1 = MR Reset Warn timer expired

**8.5.1.8 MASK0 Register (Address = 0x7) [reset = 0x0]**

 MASK0 is shown in [Figure 35](#) and described in [Table 17](#).

 Return to [Summary Table](#).

**Figure 35. MASK0 Register**

7	6	5	4	3	2	1	0
RESERVED	CHRG_CV_MASK	CHARGE_DONE_MASK	IINLIM_ACTIVE_MASK	VDPPM_ACTIVE_MASK	VINDPM_ACTIVE_MASK	THERMREG_ACTIVE_MASK	VIN_PGOOD_MASK
R/W-1b0	R/W-1b0	R/W-1b0	R/W-1b0	R/W-1b0	R/W-1b0	R/W-1b0	R/W-1b0

**Table 17. MASK0 Register Field Descriptions**

Bit	Field	Type	Reset	Description
7	RESERVED	R/W	1b0	Reserved 1b0 = Interrupt Not Masked 1b1 = Interrupt Masked
6	CHRG_CV_MASK	R/W	1b0	Mask for CHRG_CV interrupt 1b0 = Interrupt Not Masked 1b1 = Interrupt Masked
5	CHARGE_DONE_MASK	R/W	1b0	Mask for CHARGE_DONE interrupt 1b0 = Interrupt Not Masked 1b1 = Interrupt Masked
4	IINLIM_ACTIVE_MASK	R/W	1b0	Mask for IINLIM_ACTIVE interrupt 1b0 = Interrupt Not Masked 1b1 = Interrupt Masked
3	VDPPM_ACTIVE_MASK	R/W	1b0	Mask for VDPPM_ACTIVE interrupt 1b0 = Interrupt Not Masked 1b1 = Interrupt Masked
2	VINDPM_ACTIVE_MASK	R/W	1b0	Mask for VINDPM_ACTIVE interrupt 1b0 = Interrupt Not Masked 1b1 = Interrupt Masked
1	THERMREG_ACTIVE_MASK	R/W	1b0	Mask for THERMREG_ACTIVE interrupt 1b0 = Interrupt Not Masked 1b1 = Interrupt Masked
0	VIN_PGOOD_MASK	R/W	1b0	Mask for VIN_PGOOD interrupt 1b0 = Interrupt Not Masked 1b1 = Interrupt Masked

### 8.5.1.9 MASK1 Register (Address = 0x8) [reset = 0x0]

MASK1 is shown in [Figure 36](#) and described in [Table 18](#).

Return to [Summary Table](#).

**Figure 36. MASK1 Register**

7	6	5	4	3	2	1	0
VIN_OVP_FAULT_MASK	RESERVED	BAT_OCP_FAULT_MASK	BAT_UVLO_FAULT_MASK	TS_COLD_MASK	TS_COOL_MASK	TS_WARM_MASK	TS_HOT_MASK
R/W-1b0	R/W-1b0	R/W-1b0	R/W-1b0	R/W-1b0	R/W-1b0	R/W-1b0	R/W-1b0

**Table 18. MASK1 Register Field Descriptions**

Bit	Field	Type	Reset	Description
7	VIN_OVP_FAULT_MASK	R/W	1b0	Mask for VIN_OVP_FAULT interrupt 1b0 = Interrupt Not Masked 1b1 = Interrupt Masked
6	RESERVED	R/W	1b0	Reserved
5	BAT_OCP_FAULT_MASK	R/W	1b0	Mask for BAT_OCP_FAULT interrupt 1b0 = Interrupt Not Masked 1b1 = Interrupt Masked
4	BAT_UVLO_FAULT_MASK	R/W	1b0	Mask for BAT_UVLO_FAULT interrupt 1b0 = Interrupt Not Masked 1b1 = Interrupt Masked
3	TS_COLD_MASK	R/W	1b0	Mask for TS_COLD interrupt 1b0 = Interrupt Not Masked 1b1 = Interrupt Masked
2	TS_COOL_MASK	R/W	1b0	Mask for TS_COOL interrupt 1b0 = Interrupt Not Masked 1b1 = Interrupt Masked
1	TS_WARM_MASK	R/W	1b0	Mask for TS_WARM interrupt 1b0 = Interrupt Not Masked 1b1 = Interrupt Masked
0	TS_HOT_MASK	R/W	1b0	Mask for TS_HOT interrupt 1b0 = Interrupt Not Masked 1b1 = Interrupt Masked

**8.5.1.10 MASK2 Register (Address = 0x9) [reset = 0x71]**

 MASK2 is shown in [Figure 37](#) and described in [Table 19](#).

 Return to [Summary Table](#).

**Figure 37. MASK2 Register**

7	6	5	4	3	2	1	0
ADC_READY_FLAG	COMP1_ALAR_M_FLAG	COMP2_ALAR_M_FLAG	COMP3_ALAR_M_FLAG	RESERVED			TS_OPEN_MASK
R/W-1b0	R/W-1b1	R/W-1b1	R/W-1b1	R/W-3b000			R/W-1b1

**Table 19. MASK2 Register Field Descriptions**

Bit	Field	Type	Reset	Description
7	ADC_READY_FLAG	R/W	1b0	Mask for ADC_READY Interrupt 1b0 = Interrupt Not Masked 1b1 = Interrupt Masked
6	COMP1_ALARM_FLAG	R/W	1b1	Mask for COMP1_ALARM Interrupt 1b0 = Interrupt Not Masked 1b1 = Interrupt Masked
5	COMP2_ALARM_FLAG	R/W	1b1	Mask for COMP2_ALARM Interrupt 1b0 = Interrupt Not Masked 1b1 = Interrupt Masked
4	COMP3_ALARM_FLAG	R/W	1b1	Mask for COMP3_ALARM Interrupt 1b0 = Interrupt Not Masked 1b1 = Interrupt Masked
3-1	RESERVED	R/W	3b000	Reserved 3b000 = Interrupt Not Masked 3b001 = Interrupt Masked
0	TS_OPEN_MASK	R/W	1b1	Mask for TS_OPEN Interrupt 1b0 = Interrupt Not Masked 1b1 = Interrupt Masked



### 8.5.1.11 MASK3 Register (Address = 0xA) [reset = 0x0]

MASK3 is shown in [Figure 38](#) and described in [Table 20](#).

Return to [Summary Table](#).

**Figure 38. MASK3 Register**

7	6	5	4	3	2	1	0
RESERVED	WD_FAULT_M ASK	SAFETY_TMR _FAULT_MASK	LDO_OCP_FA ULT_MASK	IMAX_FAULT_ MASK	MRWAKE1_TI MEOUT_MASK	MRWAKE2_TI MEOUT_MASK	MRRESET_WA RN_MASK
R/W-1b0	R/W-1b0	R/W-1b0	R/W-1b0	R/W-1b0	R/W-1b0	R/W-1b0	R/W-1b0

**Table 20. MASK3 Register Field Descriptions**

Bit	Field	Type	Reset	Description
7	RESERVED	R/W	1b0	Reserved
6	WD_FAULT_MASK	R/W	1b0	Mask for WD_FAULT Interrupt 1b0 = Interrupt Not Masked 1b1 = Interrupt Masked
5	SAFETY_TMR_FAULT_M ASK	R/W	1b0	Mask for SAFETY_TIMER_FAULT Interrupt 1b0 = Interrupt Not Masked 1b1 = Interrupt Masked
4	LDO_OCP_FAULT_MAS K	R/W	1b0	Mask for LDO_OCP_FAULT Interrupt 1b0 = Interrupt Not Masked 1b1 = Interrupt Masked
3	IMAX_FAULT_MASK	R/W	1b0	Mask for IMAX_FAULT Interrupt 1b0 = Interrupt Not Masked 1b1 = Interrupt Masked
2	MRWAKE1_TIMEOUT_M ASK	R/W	1b0	Mask for MRWAKE1_TIMEOUT Interrupt 1b0 = Interrupt Not Masked 1b1 = Interrupt Masked
1	MRWAKE2_TIMEOUT_M ASK	R/W	1b0	Mask for MRWAKE2_TIMEOUT Interrupt 1b0 = Interrupt Not Masked 1b1 = Interrupt Masked
0	MRRESET_WARN_MAS K	R/W	1b0	Mask for MRRESET_WARN Interrupt 1b0 = Interrupt Not Masked 1b1 = Interrupt Masked

**8.5.1.12 VBAT\_CTRL Register (Address = 0x12) [reset = 0x3C]**

 VBAT\_CTRL is shown in [Figure 39](#) and described in [Table 21](#).

 Return to [Summary Table](#).

**Figure 39. VBAT\_CTRL Register**

7	6	5	4	3	2	1	0
RESERVED							VBAT_REG_6:0
R/W-1b0							R/W-7b0111100

**Table 21. VBAT\_CTRL Register Field Descriptions**

Bit	Field	Type	Reset	Description
7	RESERVED	R/W	1b0	Reserved
6-0	VBAT_REG_6:0	R/W	7b0111100	Battery Regulation Voltage VBATREG = 3.6V + VBAT_REG code x 10mV If a value greater than 4.6V is written, the setting will go to 4.6V

**8.5.1.13 ICHG\_CTRL Register (Address = 0x13) [reset = 0x8]**

ICHG\_CTRL is shown in [Figure 40](#) and described in [Table 22](#).

Return to [Summary Table](#).

**Figure 40. ICHG\_CTRL Register**

7	6	5	4	3	2	1	0
ICHG_7:0							
R/W-8b00001000							

**Table 22. ICHG\_CTRL Register Field Descriptions**

Bit	Field	Type	Reset	Description
7-0	ICHG_7:0	R/W	8b0000100 0	Fast Charge Current Fast Charge Current = 1.25mA x ICHG code (ICHARGE_RANGE =0) Fast Charge Current = 2.5mA x ICHG code (ICHARGE_RANGE =1)

**8.5.1.14 PCHRGCTRL Register (Address = 0x14) [reset = 0x2]**

 PCHRGCTRL is shown in [Figure 41](#) and described in [Table 23](#).

 Return to [Summary Table](#).

**Figure 41. PCHRGCTRL Register**

7	6	5	4	3	2	1	0
ICHARGE_RANGE	RESERVED		IPRECHG_4:0				
R/W-1b0	R/W-2b00		R/W-5b00010				

**Table 23. PCHRGCTRL Register Field Descriptions**

Bit	Field	Type	Reset	Description
7	ICHARGE_RANGE	R/W	1b0	Charge Current Step 1b0 = 1.25mA step (318.75mA max charge current) 1b1 = 2.5mA step (500mA max charge current)
6-5	RESERVED	R/W	2b00	Reserved
4-0	IPRECHG_4:0	R/W	5b00010	Pre-Charge Current Pre-Charge Current = 1.25mA x IPRECHG code (ICHARGE_RANGE =0) Pre-Charge Current = 2.5mA x IPRECHG code (ICHARGE_RANGE =1)

**8.5.1.15 TERMCTRL Register (Address = 0x15) [reset = 0x14]**

 TERMCTRL is shown in [Figure 42](#) and described in [Table 24](#).

 Return to [Summary Table](#).

**Figure 42. TERMCTRL Register**

7	6	5	4	3	2	1	0
RESERVED		ITERM_4:0					TERM_DISABLE
R/W-2b00		R/W-5b01010					R/W-1b0

**Table 24. TERMCTRL Register Field Descriptions**

Bit	Field	Type	Reset	Description
7-6	RESERVED	R/W	2b00	Reserved
5-1	ITERM_4:0	R/W	5b01010	Termination Current Programmable Range = 1% to 31% of ICHRG 5b00000 = Do not Use 5b00001 = 1% of ICHRG 5b00010 = 2% of ICHRG 5b00100 = 4% of ICHRG 5b01000 = 8% of ICHRG 5b10000 = 16% of ICHRG
0	TERM_DISABLE	R/W	1b0	Termination Disable 1b0 = Termination Enabled 1b1 = Termination Disabled

**8.5.1.16 BUVLO Register (Address = 0x16) [reset = 0x0]**

 BUVLO is shown in [Figure 43](#) and described in [Table 25](#).

 Return to [Summary Table](#).

**Figure 43. BUVLO Register**

7	6	5	4	3	2	1	0
RESERVED		VLOWV_SEL	IBAT_OCP_ILIM_1:0		BUVLO_2:0		
R/W-2b00		R/W-1b0	R/W-2b00		R/W-3b000		

**Table 25. BUVLO Register Field Descriptions**

Bit	Field	Type	Reset	Description
7-6	RESERVED	R/W	2b00	Reserved
5	VLOWV_SEL	R/W	1b0	Pre-charge to Fast Charge Threshold 1b0 = 3.0V 1b1 = 2.8V
4-3	IBAT_OCP_ILIM_1:0	R/W	2b00	Battery Over-Current Protection Threshold 2b00 = 1200mA 2b01 = 1500mA 2b10 = 1500mA 2b11 = Disabled
2-0	BUVLO_2:0	R/W	3b000	Battery UVLO Voltage 3b000 = 3.0V 3b001 = 3.0V 3b010 = 3.0V 3b011 = 2.8V 3b100 = 2.6V 3b101 = 2.4V 3b110 = 2.2V 3b111 = Disabled

**8.5.1.17 CHARGERCTRL0 Register (Address = 0x17) [reset = 0x82]**

 CHARGERCTRL0 is shown in [Figure 44](#) and described in [Table 26](#).

 Return to [Summary Table](#).

**Figure 44. CHARGERCTRL0 Register**

7	6	5	4	3	2	1	0
TS_EN	TS_CONTROL_MODE	VRH_THRESH	WATCHDOG_DISABLE	2XTMR_EN	SAFETY_TIMER_LIMIT_1:0		RESERVED
R/W-1b1	R/W-1b0	R/W-1b0	R/W-1b0	R/W-1b0	R/W-2b01		R/W-1b0

**Table 26. CHARGERCTRL0 Register Field Descriptions**

Bit	Field	Type	Reset	Description
7	TS_EN	R/W	1b1	TS Function Enable 1b0 = TS function disabled (Only charge control is disabled. TS monitoring is enabled) 1b1 = TS function enabled
6	TS_CONTROL_MODE	R/W	1b0	TS Function Control Mode 1b0 = Custom (JEITA) 1b1 = Disable charging on HOT/COLD Only
5	VRH_THRESH	R/W	1b0	Recharge Voltage Threshold 1b0 = 140mV 1b1 = 200mV
4	WATCHDOG_DISABLE	R/W	1b0	Watchdog Timer Disable 1b0 = Watchdog timer enabled 1b1 = Watchdog timer disabled
3	2XTMR_EN	R/W	1b0	Enable 2X Safety Timer 1b0 = The timer is not slowed at any time 1b1 = The timer is slowed by 2x when in any control other than CC or CV
2-1	SAFETY_TIMER_LIMIT_1:0	R/W	2b01	Charger Safety Timer 2b00 = 3 Hr Fast Charge 2b01 = 6 Hr Fast Charge 2b10 = 12 Hr Fast Charge 2b11 = Disabled
0	RESERVED	R/W	1b0	Reserved

**8.5.1.18 CHARGERCTRL1 Register (Address = 0x18) [reset = 0x42]**

 CHARGERCTRL1 is shown in [Figure 45](#) and described in [Table 27](#).

 Return to [Summary Table](#).

**Figure 45. CHARGERCTRL1 Register**

7	6	5	4	3	2	1	0
VINDPM_DIS	VINPDM_2:0			DPPM_DIS	THERM_REG_2:0		
R/W-1b0	R/W-3b100			R/W-1b0	R/W-3b010		

**Table 27. CHARGERCTRL1 Register Field Descriptions**

Bit	Field	Type	Reset	Description
7	VINDPM_DIS	R/W	1b0	Disable VINDPM Function 1b0 = VINDPM Enabled 1b1 = VINDPM Disabled
6-4	VINPDM_2:0	R/W	3b100	VINDPM Level Selection 3b000 = 4.2V 3b001 = 4.3V 3b010 = 4.4V 3b011 = 4.5V 3b100 = 4.6V 3b101 = 4.7V 3b110 = 4.8V 3b111 = 4.9V
3	DPPM_DIS	R/W	1b0	DPPM Disable 1b0 = DPPM function enabled 1b1 = DPPM function disabled
2-0	THERM_REG_2:0	R/W	3b010	Thermal Charge Current Foldback Threshold (Thermal Regulation) . Note: Threshold accuracy $\pm 20^{\circ}\text{C}$ 3b000 = 70°C 3b001 = 75°C 3b010 = 80°C 3b011 = 85°C 3b100 = 90°C 3b101 = Reserved 3b110 = Reserved 3b111 = Disabled



**8.5.1.19 ILIMCTRL Register (Address = 0x19) [reset = 0x1]**

 ILIMCTRL is shown in [Figure 46](#) and described in [Table 28](#).

 Return to [Summary Table](#).

**Figure 46. ILIMCTRL Register**

7	6	5	4	3	2	1	0
RESERVED					ILIM_2:0		
R/W-5b00000					R/W-3b001		

**Table 28. ILIMCTRL Register Field Descriptions**

Bit	Field	Type	Reset	Description
7-3	RESERVED	R/W	5b00000	Reserved
2-0	ILIM_2:0	R/W	3b001	Input Current Limit Level Selection 3b000 = 50mA 3b001 = 100mA 3b010 = 150mA 3b011 = 200mA 3b100 = 300mA 3b101 = 400mA 3b110 = 500mA 3b111 = 600mA

**8.5.1.20 LDOCTRL Register (Address = 0x1D) [reset = 0xB0]**

 LDOCTRL is shown in [Figure 47](#) and described in [Table 29](#).

 Return to [Summary Table](#).

**Figure 47. LDOCTRL Register**

7	6	5	4	3	2	1	0
EN_LS_LDO	VLDO_4:0					LDO_SWITCH_CONFIG	RESERVED
R/W-1b1	R/W-5b01100					R/W-1b0	R/W-1b0

**Table 29. LDOCTRL Register Field Descriptions**

Bit	Field	Type	Reset	Description
7	EN_LS_LDO	R/W	1b1	LS/LDO Enable 1b0 = Disable LS/LDO 1b1 = Enable LS/LDO
6-2	VLDO_4:0	R/W	5b01100	LDO output voltage setting LDO Voltage = 600mV + VLDO Code x 100mV
1	LDO_SWITCH_CONFIG	R/W	1b0	LDO / Load Switch Configuration Select 1b0 = LDO 1b1 = Load Switch
0	RESERVED	R/W	1b0	Reserved

**8.5.1.21 MRCTRL Register (Address = 0x30) [reset = 0x2A]**

 MRCTRL is shown in [Figure 48](#) and described in [Table 30](#).

 Return to [Summary Table](#).

**Figure 48. MRCTRL Register**

7	6	5	4	3	2	1	0
MR_RESET_VIN	MR_WAKE1_TIMER	MR_WAKE2_TIMER	MR_RESET_WARN_1:0		MR_HW_RESET_1:0		RESERVED
R/W-1b0	R/W-1b0	R/W-1b1	R/W-2b01		R/W-2b01		R/W-1b0

**Table 30. MRCTRL Register Field Descriptions**

Bit	Field	Type	Reset	Description
7	MR_RESET_VIN	R/W	1b0	VIN Power Good gated MR Reset Enable 1b0 = Reset sent when /MR reset time is met regardless of VIN state 1b1 = Reset sent when MR reset is met and Vin is valid
6	MR_WAKE1_TIMER	R/W	1b0	Wake 1 Timer setting 1b0 = 125ms 1b1 = 500ms
5	MR_WAKE2_TIMER	R/W	1b1	Wake 2 Timer setting 1b0 = 1s 1b1 = 2s
4-3	MR_RESET_WARN_1:0	R/W	2b01	MR Reset Warn Timer setting 2b00 = MR_HW_RESET - 0.5s 2b01 = MR_HW_RESET - 1.0s 2b10 = MR_HW_RESET - 1.5s 2b11 = MR_HW_RESET - 2.0s
2-1	MR_HW_RESET_1:0	R/W	2b01	MR HW Reset Timer setting 2b00 = 4s 2b01 = 8s 2b10 = 10s 2b11 = 14s
0	RESERVED	R/W	1b0	Reserved

**8.5.1.22 ICCTRL0 Register (Address = 0x35) [reset = 0x10]**

 ICCTRL0 is shown in [Figure 49](#) and described in [Table 31](#).

 Return to [Summary Table](#).

**Figure 49. ICCTRL0 Register**

7	6	5	4	3	2	1	0
EN_SHIP_MODE	RESERVED	AUTOWAKE_1:0		RESERVED	GLOBAL_INT_MASK	HW_RESET	SW_RESET
R/W-1b0	R/W-1b0	R/W-2b01		R/W-1b0	R/W-1b0	R/W-1b0	R/W-1b0

**Table 31. ICCTRL0 Register Field Descriptions**

Bit	Field	Type	Reset	Description
7	EN_SHIP_MODE	R/W	1b0	Ship Mode Enable 1b0 = Normal operation 1b1 = Enter Ship Mode when VIN is not valid and /MR is high
6	RESERVED	R/W	1b0	Reserved
5-4	AUTOWAKE_1:0	R/W	2b01	Auto-wakeup Timer (TRESTART) for /MR HW Reset 2b00 = 0.6s 2b01 = 1.2s 2b10 = 2.4s 2b11 = 5s
3	RESERVED	R/W	1b0	Reserved
2	GLOBAL_INT_MASK	R/W	1b0	Global Interrupt Mask 1b0 = Normal Operation 1b1 = Mask all interrupts
1	HW_RESET	R/W	1b0	HW Reset 1b0 = Normal operation 1b1 = HW Reset. Temporarily power down all power rails, except VDD. I <sup>2</sup> C Register go to default settings.
0	SW_RESET	R/W	1b0	SW_Reset 1b0 = Normal operation 1b1 = SW Reset. I <sup>2</sup> C Registers go to default settings.

### 8.5.1.23 ICCTRL1 Register (Address = 0x36) [reset = 0x0]

ICCTRL1 is shown in [Figure 50](#) and described in [Table 32](#).

Return to [Summary Table](#).

**Figure 50. ICCTRL1 Register**

7	6	5	4	3	2	1	0
MR_LPRESS_ACTION_1:0	ADCIN_MODE	RESERVED	PG_MODE_1:0	PMID_MODE_1:0			
R/W-2b00	R/W-1b0	R/W-1b0	R/W-2b00	R/W-2b00			

**Table 32. ICCTRL1 Register Field Descriptions**

Bit	Field	Type	Reset	Description
7-6	MR_LPRESS_ACTION_1:0	R/W	2b00	MR Long Press Action 2b00 = HW Reset (Power Cycle) 2b01 = Do nothing 2b10 = Enter Ship Mode 2b11 = Enter Ship Mode
5	ADCIN_MODE	R/W	1b0	ADCIN Pin Mode of Operation 1b0 = General Purpose ADC input (no Internal biasing) 1b1 = 10K NTC ADC input (80uA biasing)
4	RESERVED	R/W	1b0	Reserved
3-2	PG_MODE_1:0	R/W	2b00	PG Pin Mode of Operation 2b00 = VIN Power Good 2b01 = Deglitched Level Shifted /MR 2b10 = General Purpose Open Drain Output 2b11 = General Purpose Open Drain Output
1-0	PMID_MODE_1:0	R/W	2b00	PMID Control Sets how PMID is powered in any state, except Ship Mode. 2b00 = PMID powered from BAT or VIN if present 2b01 = PMID powered from BAT only, even if VIN is present 2b10 = PMID disconnected and left floating 2b11 = PMID disconnected and pulled down.

**8.5.1.24 ICCTRL2 Register (Address = 0x37) [reset = 0x0]**

 ICCTRL2 is shown in [Figure 51](#) and described in [Table 33](#).

 Return to [Summary Table](#).

**Figure 51. ICCTRL2 Register**

7	6	5	4	3	2	1	0
RESERVED			GPO_PG	RESERVED		HWRESET_14 S_WD	CHARGER_DI SABLE
R/W-3b000			R/W-1b0	R/W-2b00		R/W-1b0	R/W-1b0

**Table 33. ICCTRL2 Register Field Descriptions**

Bit	Field	Type	Reset	Description
7-5	RESERVED	R/W	3b000	Reserved
4	GPO_PG	R/W	1b0	/PG General Purpose Output State Control 1b0 = Pulled Down 1b1 = High Z
3-2	RESERVED	R/W	2b00	Reserved
1	HWRESET_14S_WD	R/W	1b0	Enable for 14-second I2C watchdog timer for HW Reset after VIN connection 1b0 = Timer disabled 1b1 = Device will perform HW reset if no I2C transaction is done within 14s after VIN is present
0	CHARGER_DISABLE	R/W	1b0	Charge Disable 1b0 = Charge enabled if /CE pin is low 1b1 = Charge disabled

### 8.5.1.25 ADCCTRL0 Register (Address = 0x40) [reset = 0x2]

ADCCTRL0 is shown in [Figure 52](#) and described in [Table 34](#).

Return to [Summary Table](#).

**Figure 52. ADCCTRL0 Register**

7	6	5	4	3	2	1	0
ADC_READ_RATE_1:0		ADC_CONV_S TART	ADC_CONV_SPEED_1:0		ADC_COMP1_2:0		
R/W-2b00		R/W-1b0	R/W-2b00		R/W-3b010		

**Table 34. ADCCTRL0 Register Field Descriptions**

Bit	Field	Type	Reset	Description
7-6	ADC_READ_RATE_1:0	R/W	2b00	Read rate for ADC measurements in BAT Only operation 2b00 = Manual Read (Measurement done when ADC_CONV_START is set) 2b01 = Continuous 2b10 = Every 1 second 2b11 = Every 1 minute
5	ADC_CONV_START	R/W	1b0	ADC Conversion Start Trigger Bit goes back to 0 when conversion is complete 1b0 = No ADC conversion 1b1 = Initiates ADC measurement in Manual Read operation
4-3	ADC_CONV_SPEED_1:0	R/W	2b00	ADC Conversion Speed 2b00 = 24ms (Highest accuracy) 2b01 = 12ms 2b10 = 6ms 2b11 = 3ms
2-0	ADC_COMP1_2:0	R/W	3b010	ADC Channel for Comparator 1 3b000 = Disabled 3b001 = ADCIN 3b010 = TS 3b011 = VBAT 3b100 = ICHARGE 3b101 = VIN 3b110 = PMID 3b111 = IIN

**8.5.1.26 ADCCTRL1 Register (Address = 0x41) [reset = 0x40]**

 ADCCTRL1 is shown in [Figure 53](#) and described in [Table 35](#).

 Return to [Summary Table](#).

**Figure 53. ADCCTRL1 Register**

7	6	5	4	3	2	1	0
ADC_COMP2_2:0			ADC_COMP3_2:0			RESERVED	
R/W-3b010			R/W-3b000			R/W-2b00	

**Table 35. ADCCTRL1 Register Field Descriptions**

Bit	Field	Type	Reset	Description
7-5	ADC_COMP2_2:0	R/W	3b010	ADC Channel for Comparator 2 3b000 = Disabled 3b001 = ADCIN 3b010 = TS 3b011 = VBAT 3b100 = ICHARGE 3b101 = VIN 3b110 = PMID 3b111 = IIN
4-2	ADC_COMP3_2:0	R/W	3b000	ADC Channel for Comparator 3 3b000 = Disabled 3b001 = ADCIN 3b010 = TS 3b011 = VBAT 3b100 = ICHARGE 3b101 = VIN 3b110 = PMID 3b111 = IIN
1-0	RESERVED	R/W	2b00	Reserved



**8.5.1.27 ADC\_DATA\_VBAT\_M Register (Address = 0x42) [reset = X]**

ADC\_DATA\_VBAT\_M is shown in [Figure 54](#) and described in [Table 36](#).

Return to [Summary Table](#).

**Figure 54. ADC\_DATA\_VBAT\_M Register**

7	6	5	4	3	2	1	0
VBAT_ADC_15:8							
R/W-X							

**Table 36. ADC\_DATA\_VBAT\_M Register Field Descriptions**

Bit	Field	Type	Reset	Description
7-0	VBAT_ADC_15:8	R/W	X	ADC VBAT Measurement MSB

**8.5.1.28 ADC\_DATA\_VBAT\_L Register (Address = 0x43) [reset = X]**

 ADC\_DATA\_VBAT\_L is shown in [Figure 55](#) and described in [Table 37](#).

 Return to [Summary Table](#).

**Figure 55. ADC\_DATA\_VBAT\_L Register**

7	6	5	4	3	2	1	0
VBAT_ADC_7:0							
R/W-X							

**Table 37. ADC\_DATA\_VBAT\_L Register Field Descriptions**

Bit	Field	Type	Reset	Description
7-0	VBAT_ADC_7:0	R/W	X	ADC VBAT Measurement LSB

**8.5.1.29 ADC\_DATA\_TS\_M Register (Address = 0x44) [reset = X]**

ADC\_DATA\_TS\_M is shown in [Figure 56](#) and described in [Table 38](#).

Return to [Summary Table](#).

**Figure 56. ADC\_DATA\_TS\_M Register**

7	6	5	4	3	2	1	0
TS_ADC_15:8							
R/W-X							

**Table 38. ADC\_DATA\_TS\_M Register Field Descriptions**

Bit	Field	Type	Reset	Description
7-0	TS_ADC_15:8	R/W	X	ADC TS Measurement MSB

**8.5.1.30 ADC\_DATA\_TS\_L Register (Address = 0x45) [reset = X]**

 ADC\_DATA\_TS\_L is shown in [Figure 57](#) and described in [Table 39](#).

 Return to [Summary Table](#).

**Figure 57. ADC\_DATA\_TS\_L Register**

7	6	5	4	3	2	1	0
TS_ADC_7:0							
R/W-X							

**Table 39. ADC\_DATA\_TS\_L Register Field Descriptions**

Bit	Field	Type	Reset	Description
7-0	TS_ADC_7:0	R/W	X	ADC TS Measurement LSB

**8.5.1.31 ADC\_DATA\_ICHG\_M Register (Address = 0x46) [reset = X]**

ADC\_DATA\_ICHG\_M is shown in [Figure 58](#) and described in [Table 40](#).

Return to [Summary Table](#).

**Figure 58. ADC\_DATA\_ICHG\_M Register**

7	6	5	4	3	2	1	0
ICHG_ADC_15:8							
R/W-X							

**Table 40. ADC\_DATA\_ICHG\_M Register Field Descriptions**

Bit	Field	Type	Reset	Description
7-0	ICHG_ADC_15:8	R/W	X	ADC ICHG Measurement MSB

**8.5.1.32 ADC\_DATA\_ICHG\_L Register (Address = 0x47) [reset = X]**

 ADC\_DATA\_ICHG\_L is shown in [Figure 59](#) and described in [Table 41](#).

 Return to [Summary Table](#).

**Figure 59. ADC\_DATA\_ICHG\_L Register**

7	6	5	4	3	2	1	0
ICHG_ADC_7:0							
R/W-X							

**Table 41. ADC\_DATA\_ICHG\_L Register Field Descriptions**

Bit	Field	Type	Reset	Description
7-0	ICHG_ADC_7:0	R/W	X	ADC ICHG Measurement LSB

### 8.5.1.33 ADC\_DATA\_ADCIN\_M Register (Address = 0x48) [reset = X]

ADC\_DATA\_ADCIN\_M is shown in [Figure 60](#) and described in [Table 42](#).

Return to [Summary Table](#).

**Figure 60. ADC\_DATA\_ADCIN\_M Register**

7	6	5	4	3	2	1	0
ADCIN_ADC_15:8							
R/W-X							

**Table 42. ADC\_DATA\_ADCIN\_M Register Field Descriptions**

Bit	Field	Type	Reset	Description
7-0	ADCIN_ADC_15:8	R/W	X	ADC ADCIN Measurement MSB

**8.5.1.34 ADC\_DATA\_ADCIN\_L Register (Address = 0x49) [reset = X]**

 ADC\_DATA\_ADCIN\_L is shown in [Figure 61](#) and described in [Table 43](#).

 Return to [Summary Table](#).

**Figure 61. ADC\_DATA\_ADCIN\_L Register**

7	6	5	4	3	2	1	0
ADCIN_ADC_7:0							
R/W-X							

**Table 43. ADC\_DATA\_ADCIN\_L Register Field Descriptions**

Bit	Field	Type	Reset	Description
7-0	ADCIN_ADC_7:0	R/W	X	ADC ADCIN Measurement LSB



**8.5.1.35 ADC\_DATA\_VIN\_M Register (Address = 0x4A) [reset = X]**

ADC\_DATA\_VIN\_M is shown in [Figure 62](#) and described in [Table 44](#).

Return to [Summary Table](#).

**Figure 62. ADC\_DATA\_VIN\_M Register**

7	6	5	4	3	2	1	0
VIN_ADC_15:8							
R/W-X							

**Table 44. ADC\_DATA\_VIN\_M Register Field Descriptions**

Bit	Field	Type	Reset	Description
7-0	VIN_ADC_15:8	R/W	X	ADC VIN Measurement MSB

**8.5.1.36 ADC\_DATA\_VIN\_L Register (Address = 0x4B) [reset = X]**

 ADC\_DATA\_VIN\_L is shown in [Figure 63](#) and described in [Table 45](#).

 Return to [Summary Table](#).

**Figure 63. ADC\_DATA\_VIN\_L Register**

7	6	5	4	3	2	1	0
VIN_ADC_7:0							
R/W-X							

**Table 45. ADC\_DATA\_VIN\_L Register Field Descriptions**

Bit	Field	Type	Reset	Description
7-0	VIN_ADC_7:0	R/W	X	ADC VIN Measurement LSB

**8.5.1.37 ADC\_DATA\_P MID\_M Register (Address = 0x4C) [reset = X]**

ADC\_DATA\_P MID\_M is shown in [Figure 64](#) and described in [Table 46](#).

Return to [Summary Table](#).

**Figure 64. ADC\_DATA\_P MID\_M Register**

7	6	5	4	3	2	1	0
P MID_ADC_15:8							
R/W-X							

**Table 46. ADC\_DATA\_P MID\_M Register Field Descriptions**

Bit	Field	Type	Reset	Description
7-0	P MID_ADC_15:8	R/W	X	ADC P MID Measurement MSB

**8.5.1.38 ADC\_DATA\_P MID\_L Register (Address = 0x4D) [reset = X]**

 ADC\_DATA\_P MID\_L is shown in [Figure 65](#) and described in [Table 47](#).

 Return to [Summary Table](#).

**Figure 65. ADC\_DATA\_P MID\_L Register**

7	6	5	4	3	2	1	0
PMID_ADC_7:0							
R/W-X							

**Table 47. ADC\_DATA\_P MID\_L Register Field Descriptions**

Bit	Field	Type	Reset	Description
7-0	PMID_ADC_7:0	R/W	X	ADC PMID Measurement LSB

**8.5.1.39 ADC\_DATA\_IIN\_M Register (Address = 0x4E) [reset = X]**

ADC\_DATA\_IIN\_M is shown in [Figure 66](#) and described in [Table 48](#).

Return to [Summary Table](#).

**Figure 66. ADC\_DATA\_IIN\_M Register**

7	6	5	4	3	2	1	0
IIN_ADC_15:8							
R/W-X							

**Table 48. ADC\_DATA\_IIN\_M Register Field Descriptions**

Bit	Field	Type	Reset	Description
7-0	IIN_ADC_15:8	R/W	X	ADC IIN Measurement MSB

**8.5.1.40 ADC\_DATA\_IIN\_L Register (Address = 0x4F) [reset = X]**

 ADC\_DATA\_IIN\_L is shown in [Figure 67](#) and described in [Table 49](#).

 Return to [Summary Table](#).

**Figure 67. ADC\_DATA\_IIN\_L Register**

7	6	5	4	3	2	1	0
IIN_ADC_7:0							
R/W-X							

**Table 49. ADC\_DATA\_IIN\_L Register Field Descriptions**

Bit	Field	Type	Reset	Description
7-0	IIN_ADC_7:0	R/W	X	ADC IIN Measurement LSB

**8.5.1.41 ADCALARM\_COMP1\_M Register (Address = 0x52) [reset = 0x23]**

ADCALARM\_COMP1\_M is shown in [Figure 68](#) and described in [Table 50](#).

Return to [Summary Table](#).

**Figure 68. ADCALARM\_COMP1\_M Register**

7	6	5	4	3	2	1	0
1_ADCALARM_15:8							
R/W-8b00100011							

**Table 50. ADCALARM\_COMP1\_M Register Field Descriptions**

Bit	Field	Type	Reset	Description
7-0	1_ADCALARM_15:8	R/W	8b0010001 1	ADC Comparator 1 Threshold MSB

**8.5.1.42 ADCALARM\_COMP1\_L Register (Address = 0x53) [reset = 0x20]**

 ADCALARM\_COMP1\_L is shown in [Figure 69](#) and described in [Table 51](#).

 Return to [Summary Table](#).

**Figure 69. ADCALARM\_COMP1\_L Register**

7	6	5	4	3	2	1	0
1_ADCALARM_7:4				1_ADCALARM_ABOVE	RESERVED		
R/W-4b0010				R/W-1b0	R/W-3b000		

**Table 51. ADCALARM\_COMP1\_L Register Field Descriptions**

Bit	Field	Type	Reset	Description
7-4	1_ADCALARM_7:4	R/W	4b0010	ADC Comparator 1 Threshold LSB
3	1_ADCALARM_ABOVE	R/W	1b0	ADC Comparator1 Polarity 1b0 = Set Flag and send interrupt if ADC measurement becomes lower than comparator threshold 1b1 = Set Flag and send interrupt if ADC measurement is becomes higher than comparator threshold
2-0	RESERVED	R/W	3b000	Reserved



**8.5.1.43 ADCALARM\_COMP2\_M Register (Address = 0x54) [reset = 0x38]**

ADCALARM\_COMP2\_M is shown in [Figure 70](#) and described in [Table 52](#).

Return to [Summary Table](#).

**Figure 70. ADCALARM\_COMP2\_M Register**

7	6	5	4	3	2	1	0
2_ADCALARM_15:8							
R/W-8b00111000							

**Table 52. ADCALARM\_COMP2\_M Register Field Descriptions**

Bit	Field	Type	Reset	Description
7-0	2_ADCALARM_15:8	R/W	8b0011100 0	ADC Comparator 2 Threshold MSB

**8.5.1.44 ADCALARM\_COMP2\_L Register (Address = 0x55) [reset = 0x90]**

 ADCALARM\_COMP2\_L is shown in [Figure 71](#) and described in [Table 53](#).

 Return to [Summary Table](#).

**Figure 71. ADCALARM\_COMP2\_L Register**

7	6	5	4	3	2	1	0
2_ADCALARM_7:4				2_ADCALARM_ABOVE	RESERVED		
R/W-4b1001				R/W-1b0	R/W-3b000		

**Table 53. ADCALARM\_COMP2\_L Register Field Descriptions**

Bit	Field	Type	Reset	Description
7-4	2_ADCALARM_7:4	R/W	4b1001	ADC Comparator 2 Threshold LSB
3	2_ADCALARM_ABOVE	R/W	1b0	ADC Comparator 2 Polarity 1b0 = Set Flag and send interrupt if ADC measurement becomes lower than comparator threshold 1b1 = Set Flag and send interrupt if ADC measurement is becomes higher than comparator threshold
2-0	RESERVED	R/W	3b000	Reserved

**8.5.1.45 ADCALARM\_COMP3\_M Register (Address = 0x56) [reset = 0x0]**

ADCALARM\_COMP3\_M is shown in [Figure 72](#) and described in [Table 54](#).

Return to [Summary Table](#).

**Figure 72. ADCALARM\_COMP3\_M Register**

7	6	5	4	3	2	1	0
3_ADCALARM_15:8							
R/W-8b00000000							

**Table 54. ADCALARM\_COMP3\_M Register Field Descriptions**

Bit	Field	Type	Reset	Description
7-0	3_ADCALARM_15:8	R/W	8b0000000 0	ADC Comparator 3 Threshold MSB

**8.5.1.46 ADCALARM\_COMP3\_L Register (Address = 0x57) [reset = 0x0]**

 ADCALARM\_COMP3\_L is shown in [Figure 73](#) and described in [Table 55](#).

 Return to [Summary Table](#).

**Figure 73. ADCALARM\_COMP3\_L Register**

7	6	5	4	3	2	1	0
3_ADCALARM_7:4				3_ADCALARM_ABOVE	RESERVED		
R/W-4b0000				R/W-1b0	R/W-3b000		

**Table 55. ADCALARM\_COMP3\_L Register Field Descriptions**

Bit	Field	Type	Reset	Description
7-4	3_ADCALARM_7:4	R/W	4b0000	ADC Comparator 3 Threshold LSB
3	3_ADCALARM_ABOVE	R/W	1b0	ADC Comparator 3 Polarity 1b0 = Set Flag and send interrupt if ADC measurement becomes lower than comparator threshold 1b1 = Set Flag and send interrupt if ADC measurement is becomes higher than comparator threshold
2-0	RESERVED	R/W	3b000	Reserved

**8.5.1.47 ADC\_READ\_EN Register (Address = 0x58) [reset = 0x0]**

 ADC\_READ\_EN is shown in [Figure 74](#) and described in [Table 56](#).

 Return to [Summary Table](#).

**Figure 74. ADC\_READ\_EN Register**

7	6	5	4	3	2	1	0
EN_IIN_READ	EN_PMIID_READ	EN_ICHG_READ	EN_VIN_READ	EN_VBAT_READ	EN_TS_READ	EN_ADCIN_READ	RESERVED
R/W-1b0	R/W-1b0	R/W-1b0	R/W-1b0	R/W-1b0	R/W-1b0	R/W-1b0	R/W-1b0

**Table 56. ADC\_READ\_EN Register Field Descriptions**

Bit	Field	Type	Reset	Description
7	EN_IIN_READ	R/W	1b0	Enable measurement for Input Current (IIN) Channel 1b0 = ADC measurement disabled 1b1 = ADC measurement enabled
6	EN_PMIID_READ	R/W	1b0	Enable measurement for PMID Channel 1b0 = ADC measurement disabled 1b1 = ADC measurement enabled
5	EN_ICHG_READ	R/W	1b0	Enable measurement for Charge Current Channel 1b0 = ADC measurement disabled 1b1 = ADC measurement enabled
4	EN_VIN_READ	R/W	1b0	Enable measurement for Input Voltage (VIN) Channel 1b0 = ADC measurement disabled 1b1 = ADC measurement enabled
3	EN_VBAT_READ	R/W	1b0	Enable measurement for Battery Voltage (VBAT) Channel 1b0 = ADC measurement disabled 1b1 = ADC measurement enabled
2	EN_TS_READ	R/W	1b0	Enable measurement for TS Channel 1b0 = ADC measurement disabled 1b1 = ADC measurement enabled
1	EN_ADCIN_READ	R/W	1b0	Enable measurement for ADCIN Channel 1b0 = ADC measurement disabled 1b1 = ADC measurement enabled
0	RESERVED	R/W	1b0	Reserved

**8.5.1.48 TS\_FASTCHGCTRL Register (Address = 0x61) [reset = 0x34]**

 TS\_FASTCHGCTRL is shown in [Figure 75](#) and described in [Table 57](#).

 Return to [Summary Table](#).

**Figure 75. TS\_FASTCHGCTRL Register**

7	6	5	4	3	2	1	0
RESERVED	TS_VBAT_REG_2:0			RESERVED	TS_ICHRG_2:0		
R/W-1b0	R/W-3b011			R/W-1b0	R/W-3b100		

**Table 57. TS\_FASTCHGCTRL Register Field Descriptions**

Bit	Field	Type	Reset	Description
7	RESERVED	R/W	1b0	Reserved
6-4	TS_VBAT_REG_2:0	R/W	3b011	Reduced target battery voltage during Warm 3b000 = No reduction 3b001 = VBAT_REG - 50mV 3b010 = VBAT_REG - 100mV 3b011 = VBAT_REG - 150mV 3b100 = VBAT_REG - 200mV 3b101 = VBAT_REG - 250mV 3b110 = VBAT_REG - 300mV 3b111 = VBAT_REG - 350mV
3	RESERVED	R/W	1b0	Reserved
2-0	TS_ICHRG_2:0	R/W	3b100	Fast charge current when decreased by TS function 3b000 = No reduction 3b001 = 0.875 x ICHG 3b010 = 0.750 x ICHG 3b011 = 0.625 x ICHG 3b100 = 0.500 x ICHG 3b101 = 0.375 x ICHG 3b110 = 0.250 x ICHG 3b111 = 0.125 x ICHG

**8.5.1.49 TS\_COLD Register (Address = 0x62) [reset = 0x7C]**

 TS\_COLD is shown in [Figure 76](#) and described in [Table 58](#).

 Return to [Summary Table](#).

**Figure 76. TS\_COLD Register**

7	6	5	4	3	2	1	0
TS_COLD_7:0							
R/W-8b01111100							

**Table 58. TS\_COLD Register Field Descriptions**

Bit	Field	Type	Reset	Description
7-0	TS_COLD_7:0	R/W	8b0111110 0	TS Cold Threshold 1b = 4.688 mV 10b = 9.375 mV 100b = 18.75 mV 1000b = 37.5 mV 10000b = 75 mV 100000b = 150 mV 1000000b = 300 mV 10000000b = 600mV

**8.5.1.50 TS\_COOL Register (Address = 0x63) [reset = 0x6D]**

 TS\_COOL is shown in [Figure 77](#) and described in [Table 59](#).

 Return to [Summary Table](#).

**Figure 77. TS\_COOL Register**

7	6	5	4	3	2	1	0
TS_COOL_7:0							
R/W-8b01101101							

**Table 59. TS\_COOL Register Field Descriptions**

Bit	Field	Type	Reset	Description
7-0	TS_COOL_7:0	R/W	8b0110110 1	TS Cool Threshold 1b = 4.688 mV 10b = 9.375 mV 100b = 18.75 mV 1000b = 37.5 mV 10000b = 75 mV 100000b = 150 mV 1000000b = 300 mV 10000000b = 600mV



**8.5.1.51 TS\_WARM Register (Address = 0x64) [reset = 0x38]**

 TS\_WARM is shown in [Figure 78](#) and described in [Table 60](#).

 Return to [Summary Table](#).

**Figure 78. TS\_WARM Register**

7	6	5	4	3	2	1	0
TS_WARM_7:0							
R/W-8b00111000							

**Table 60. TS\_WARM Register Field Descriptions**

Bit	Field	Type	Reset	Description
7-0	TS_WARM_7:0	R/W	8b0011100 0	TS Warm Threshold 1b = 4.688 mV 10b = 9.375 mV 100b = 18.75 mV 1000b = 37.5 mV 10000b = 75 mV 100000b = 150 mV 1000000b = 300 mV 10000000b = 600mV

**8.5.1.52 TS\_HOT Register (Address = 0x65) [reset = 0x27]**

 TS\_HOT is shown in [Figure 79](#) and described in [Table 61](#).

 Return to [Summary Table](#).

**Figure 79. TS\_HOT Register**

7	6	5	4	3	2	1	0
TS_HOT_7:0							
R/W-8b00100111							

**Table 61. TS\_HOT Register Field Descriptions**

Bit	Field	Type	Reset	Description
7-0	TS_HOT_7:0	R/W	8b0010011 1	TS Hot Threshold 1b = 4.688 mV 10b = 9.375 mV 100b = 18.75 mV 1000b = 37.5 mV 10000b = 75 mV 100000b = 150 mV 1000000b = 300 mV 10000000b = 600 mV

**8.5.1.53 DEVICE\_ID Register (Address = 0x6F) [reset = 0x20]**

 DEVICE\_ID is shown in [Figure 80](#) and described in [Table 62](#).

 Return to [Summary Table](#).

**Figure 80. DEVICE\_ID Register**

7	6	5	4	3	2	1	0
DEVICE_ID_7:0							
R-8b00100000							

**Table 62. DEVICE\_ID Register Field Descriptions**

Bit	Field	Type	Reset	Description
7-0	DEVICE_ID_7:0	R	8b0010000 0	Device ID 100000b = BQ25150

## 9 Application and Implementation

### NOTE

Information in the following applications sections is not part of the TI component specification, and TI does not warrant its accuracy or completeness. TI's customers are responsible for determining suitability of components for their purposes. Customers should validate and test their design implementation to confirm system functionality.

### 9.1 Application Information

A typical application of the BQ25150 consists of the device configured as an I<sup>2</sup>C controlled single cell Li-ion battery charger and power path manager or small battery applications such as smart-watches and wireless headsets. A battery thermistor may be connected to the TS pin to allow the device to monitor the battery temperature and control charging as desired. A resistor must be connected to the IMAX pin to set the maximum allowable charge current and must not be left floating.

The system designer may connect the  $\overline{\text{MR}}$  input to a push-button to send interrupts to the host as the button is pressed or to allow the application's end user to reset the system. If not used this pin must be left floating or tied to BAT.

The ADCIN pin may be tied to ground or be connected to a signal which the system designer desires to measure using the integrated ADC. The signal must be scaled down to no exceed the 0-1.2V range of the ADCIN input range.

### 9.2 Typical Application

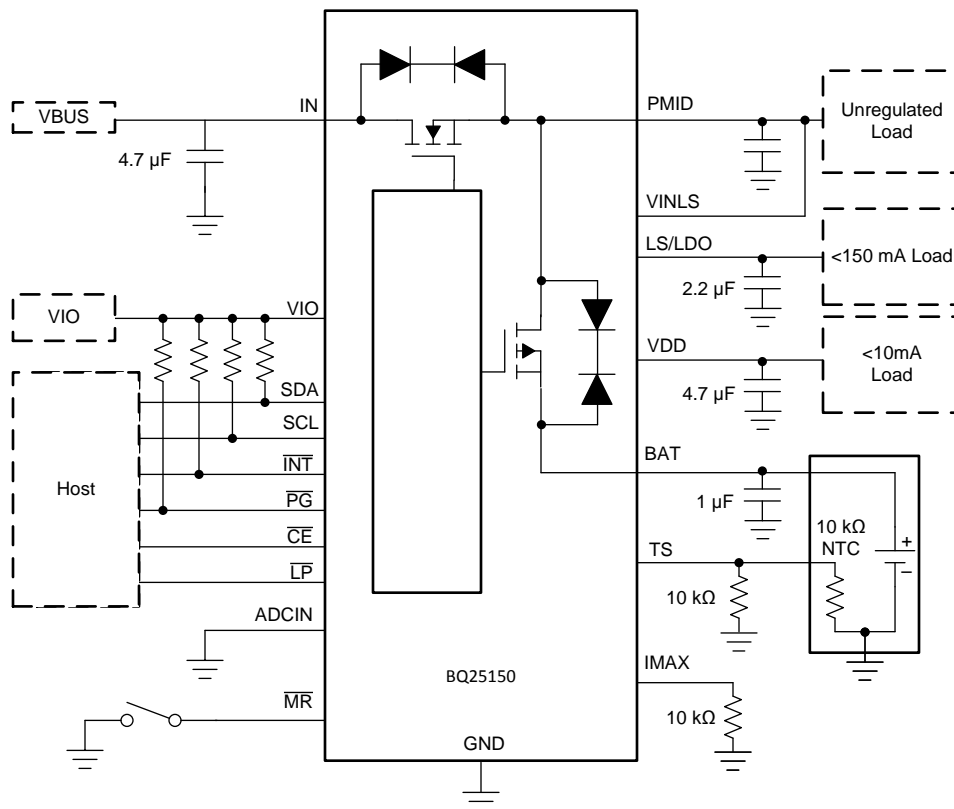

**Figure 81. Typical Application Diagram**

#### 9.2.1 Design Requirements

The design parameters for the following design example are shown in the table below.

## Typical Application (continued)

**Table 63. Design Parameters**

PARAMETER	VALUE
IN Supply Voltage	5V
Battery Regulation Voltage	4.2V
LDO Output Voltage	LDO (1.8V)
Maximum Allowed Fast Charge Charge Current (IMAX)	300mA

### 9.2.2 Detailed Design Procedure

#### 9.2.2.1 Input (IN/PMID) Capacitors

Low ESR ceramic capacitors such as X7R or X5R is preferred for input decoupling capacitors and should be places as close as possible to the supply and ground pins fo the IC. Due to the voltage derating of the capacitors it is recommended at 25V rated capacitors are used for IN and PMID pins which can normally operate at 5V. After derating the minimum capacitance must be higher than 1uF.

#### 9.2.2.2 VDD, LDO Input and Output Capacitors

A Low ESR ceramic capacitor such as X7R or X5R is recommended for the LDO decoupling capacitor. A 4.7uF capacitor is recommended for VDD output. For the LDO output a 2.2uF capacitor is recommended. The minimum supported capacitance after derating must be higher than 1uF to ensure stability. The VINLS input bypass capacitor value should match or exceed the LDO output capacitor value.

#### 9.2.2.3 TS

A 10K $\Omega$  NTC should be connected in parallel to a 10-k $\Omega$  biasing resistor connected to ground. The ground connection of both the NTC and biasing resistor must be done as close as possible to the GND pin of the device or kelvin connected to it to minimize any error in TS measurement due IR drops on the board ground lines.

If the system designer does not wish to use the TS function for charging control, a 5-k $\Omega$  resistor from TS to ground must be connected.

#### 9.2.2.4 IMAX Selection

For a 300mA maximum allowable charge current, the desired maximum FAST\_CHARGE register code (decimal) is 120 when ICHARGE\_STEP = 1 (2.5mA). Using [Equation 6](#), the calculated R<sub>IMAX</sub> value is 3.52-k $\Omega$ . Note that if ICHARGE\_STEP is set to 0 (1.25mA), the I<sub>MAX</sub> value is reduced be half to 150mA.

If the system designer does not wish to use the IMAX function to limit the maximum charge current, 10K $\Omega$  resistor from TS to ground must be connected.

#### 9.2.2.5 Recommended Passive Components

**Table 64. Recommended Passive Components**

		MIN	NOM	MAX	UNIT
C <sub>PMID</sub>	Capacitance in PMID pin	1	10	47	$\mu$ F
C <sub>LDO</sub>	LDO output capacitance	1	2.2	4.7	$\mu$ F
C <sub>VDD</sub>	VDD output capacitance	1	4.7	4.7	$\mu$ F
C <sub>BAT</sub>	BAT pin capacitance	1		–	$\mu$ F
C <sub>IN</sub>	IN input bypass capacitance	1	4.7	10	$\mu$ F
C <sub>INLS</sub>	VINLS input bypass capacitance	1		–	$\mu$ F
C <sub>TS</sub>	Capacitance from TS pin to ground	0	0	1	nF

### 9.2.3 Application Curves

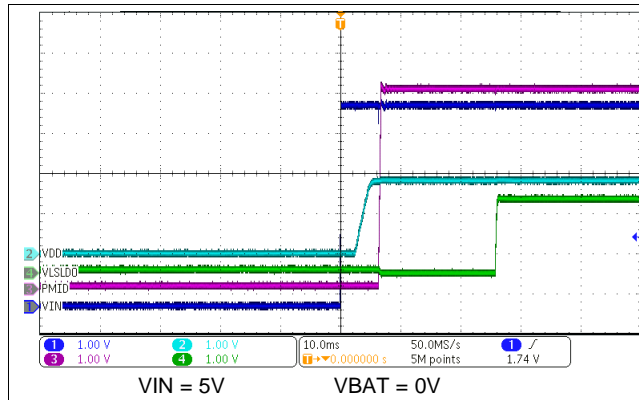

Figure 82. Power Up from IN Supply Insertion with No Battery

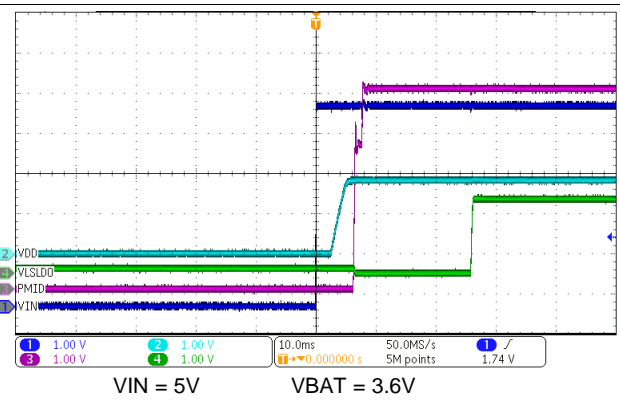

Figure 83. Power Up from Ship Mode with IN Supply Insertion

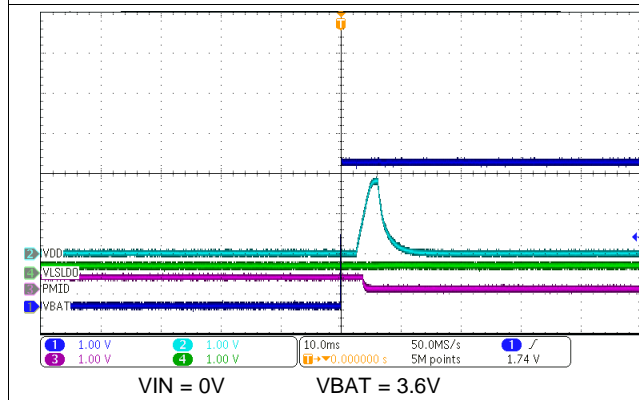

Figure 84. Wake In To Ship Mode on Battery Insertion with No IN Supply

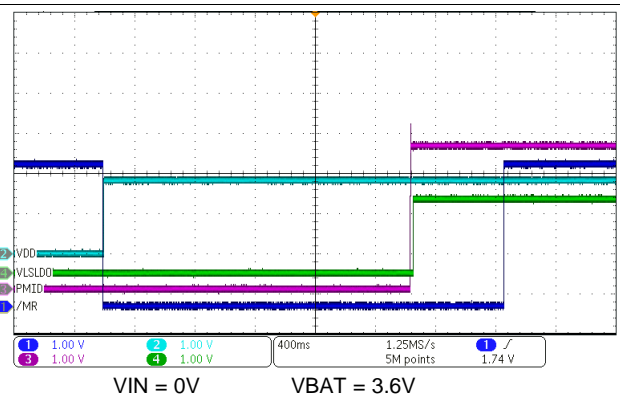

Figure 85. Power Up from Ship Mode with  $\overline{MR}$  Press

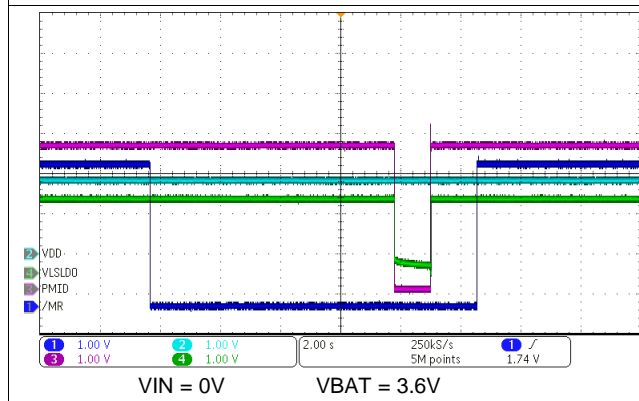

Figure 86. HW Reset on  $\overline{MR}$  Long Button Press

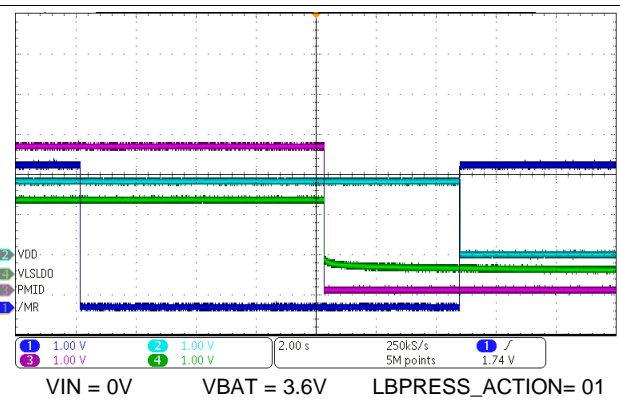

Figure 87. Ship Mode Entry with  $\overline{MR}$  Long Button Press

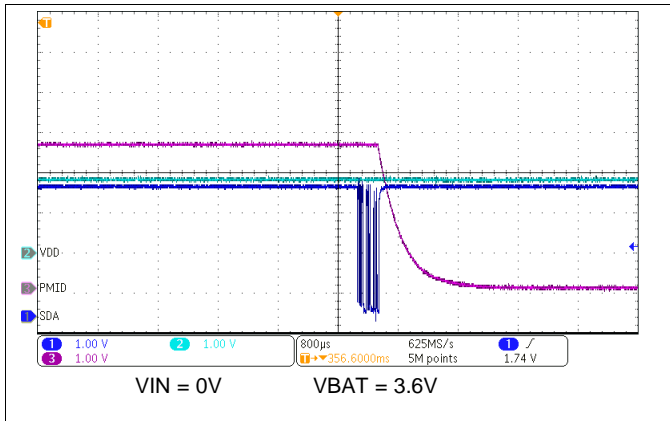

Figure 88. HW Reset Through I<sup>2</sup>C Command

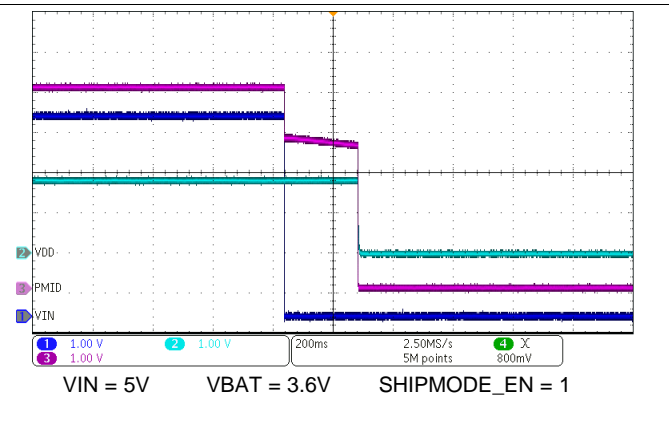

Figure 89. Ship Mode Entry on IN Supply Removal

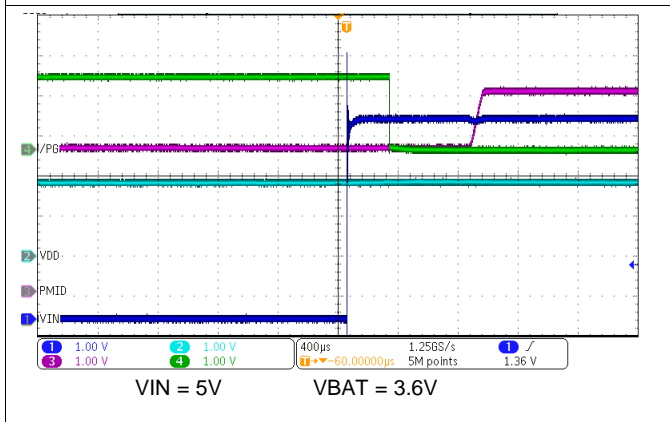

Figure 90.  $\overline{\text{PG}}$  Power Good Function - IN Supply Insertion

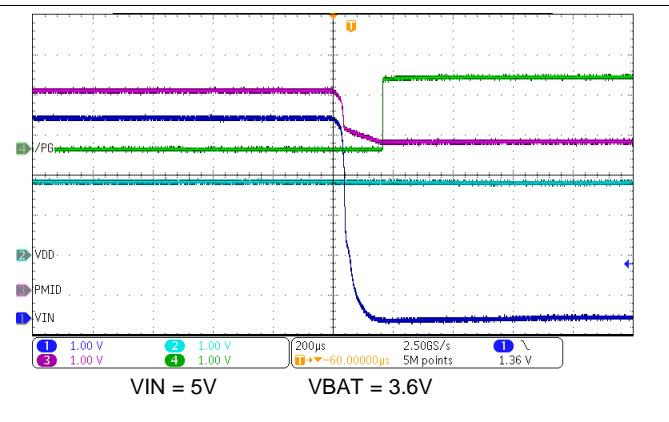

Figure 91.  $\overline{\text{PG}}$  Power Good Function - IN Supply Removal

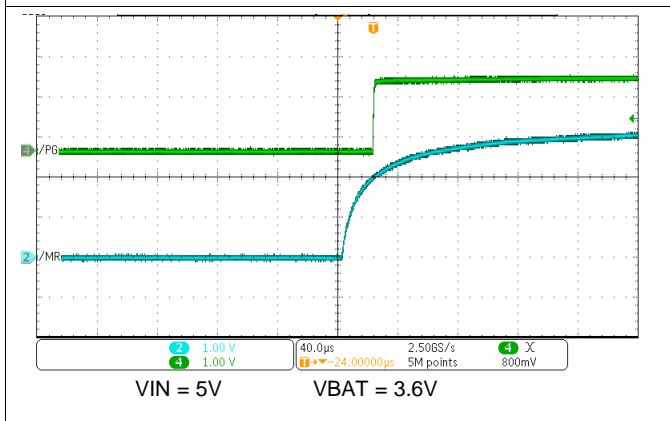

Figure 92.  $\overline{\text{PG}}$   $\overline{\text{MR}}$  Level Shift Function -  $\overline{\text{MR}}$  Rising

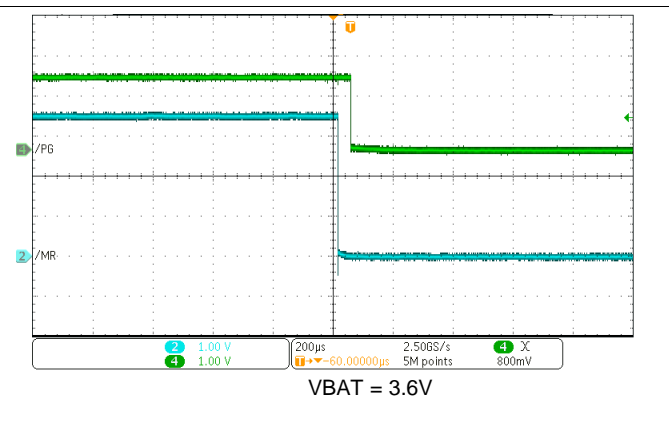

Figure 93.  $\overline{\text{PG}}$   $\overline{\text{MR}}$  Level Shift Function -  $\overline{\text{MR}}$  Falling

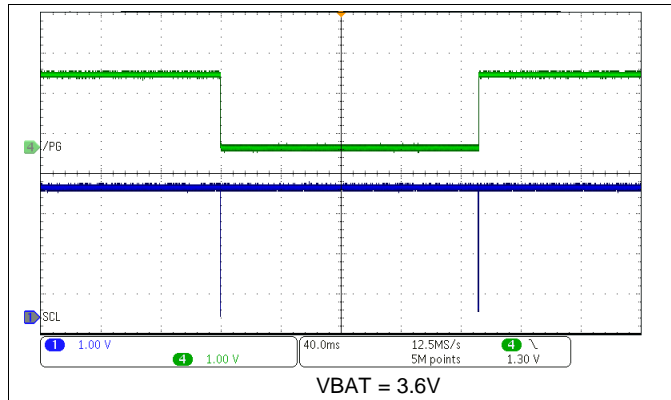

Figure 94. PG General Purpose Output Function - GPO\_PG Bit Toggle

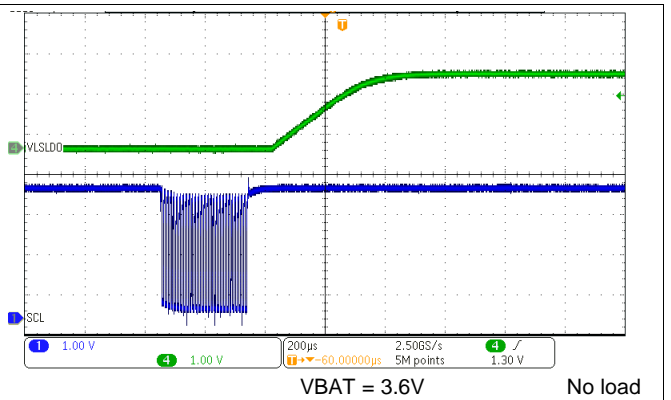

Figure 95. LDO Enable Through I<sup>2</sup>C (EN\_LS\_LDO)

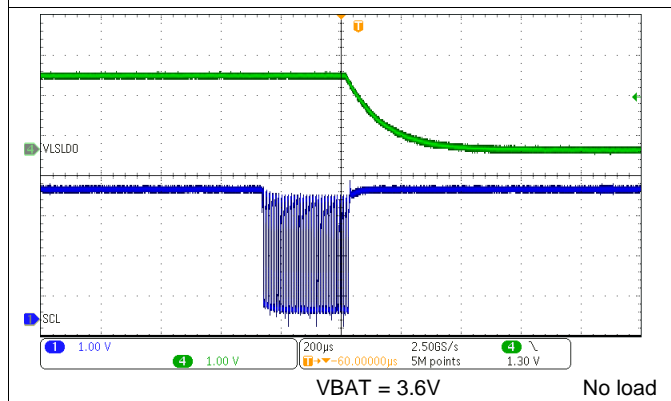

Figure 96. LDO Disable Through I<sup>2</sup>C (EN\_LS\_LDO)

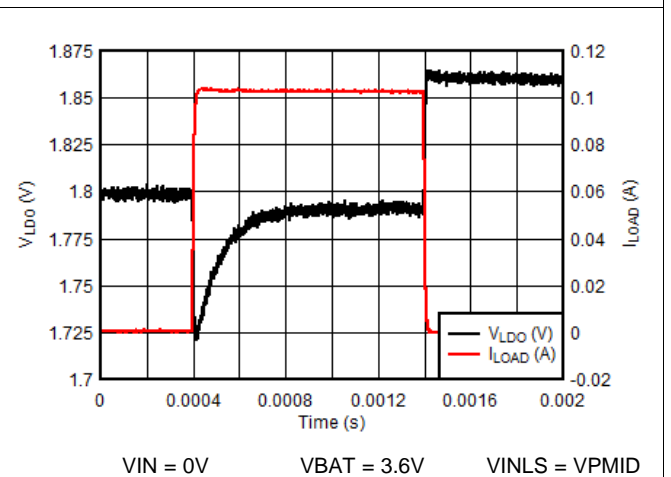

Figure 97. LDO Load Transient - VLDO = 1.8V

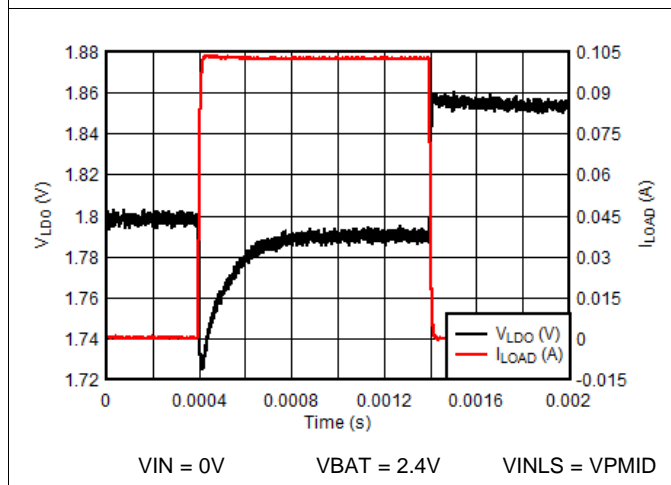

Figure 98. LDO Load Transient - VLDO = 1.8V

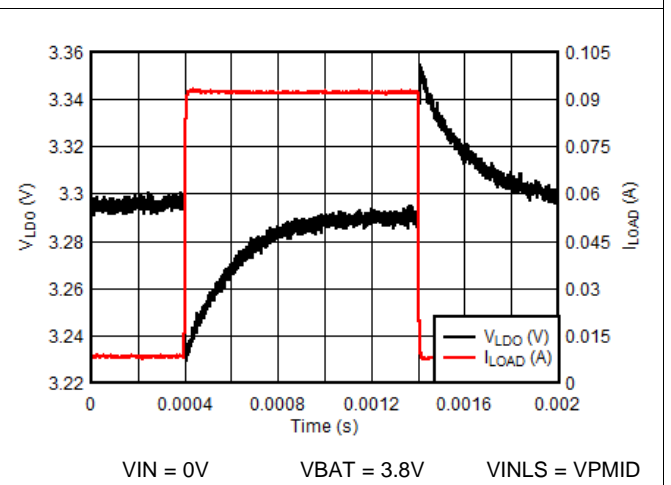
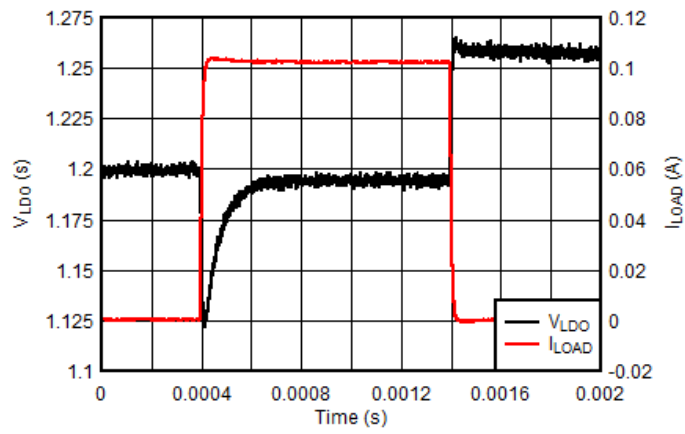

Figure 99. LDO Load Transient - VLDO = 3.3V





VIN = 0V      VBAT = 3.6V      VINLS = VPMID

Figure 100. LDO Load Transient - VLDO = 1.2V

## 10 Power Supply Recommendations

BQ25150 requires the adapter or IN supply to be between 3.4V and 5.5V with at least 600mA rating. The battery voltage must be higher than 2.4V or  $V_{BATUVLO}$  to ensure proper operation

## 11 Layout

### 11.1 Layout Guidelines

- Have solid ground plane that is tied to the GND bump
- Place LDO and VDD output capacitors as close as possible to the respective bumps and GND or ground plane with short copper trace connection
- Place PMID capacitor as close to the PMID bump as possible and GND or ground plane.

### 11.2 Layout Example

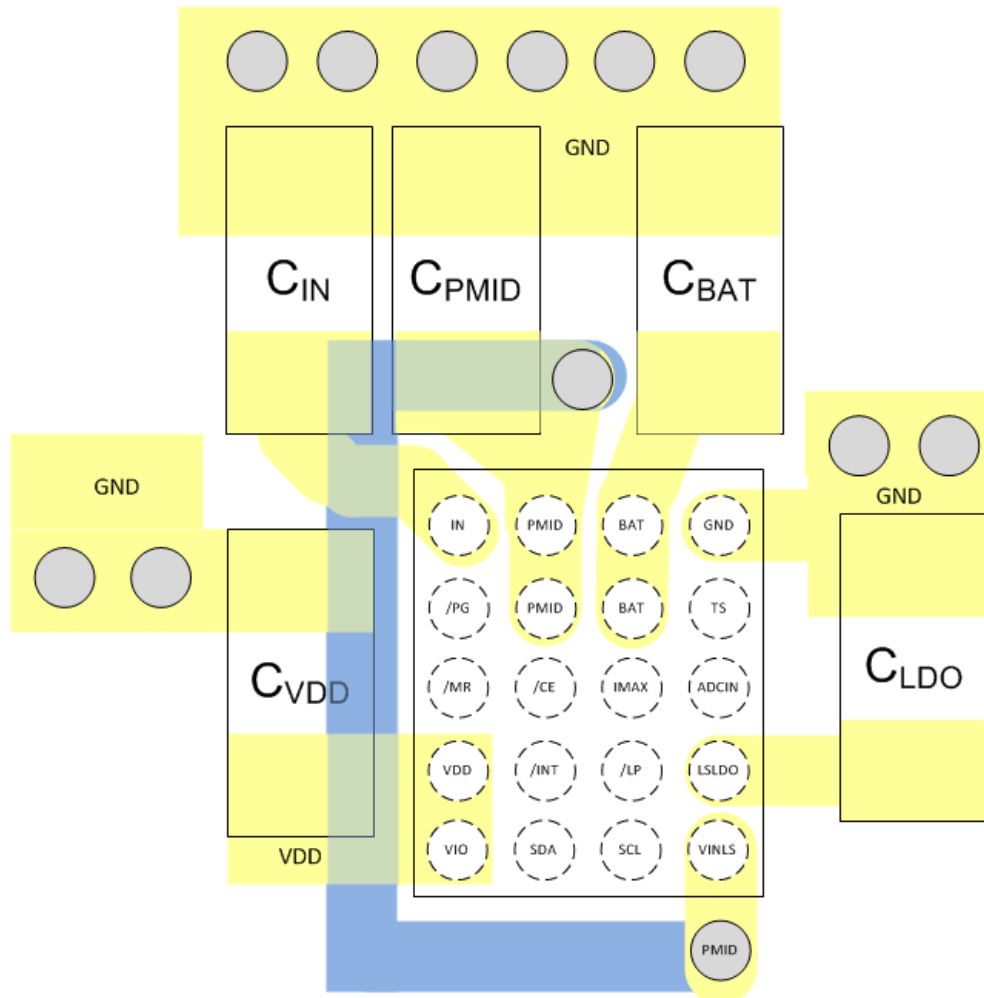

Figure 101. Layout Example

## 12 Device and Documentation Support

### 12.1 Documentation Support

#### 12.1.1 Related Documentation

For related documentation see the following: *BQ25150EVM User's Guide* ([SLUUBV0](#))

### 12.2 Receiving Notification of Documentation Updates

To receive notification of documentation updates, navigate to the device product folder on ti.com. In the upper right corner, click on *Alert me* to register and receive a weekly digest of any product information that has changed. For change details, review the revision history included in any revised document.

### 12.3 Community Resources

The following links connect to TI community resources. Linked contents are provided "AS IS" by the respective contributors. They do not constitute TI specifications and do not necessarily reflect TI's views; see TI's [Terms of Use](#).

**TI E2E™ Online Community** *TI's Engineer-to-Engineer (E2E) Community*. Created to foster collaboration among engineers. At [e2e.ti.com](#), you can ask questions, share knowledge, explore ideas and help solve problems with fellow engineers.

**Design Support** *TI's Design Support* Quickly find helpful E2E forums along with design support tools and contact information for technical support.

### 12.4 Trademarks

E2E is a trademark of Texas Instruments.  
All other trademarks are the property of their respective owners.

### 12.5 Electrostatic Discharge Caution



This integrated circuit can be damaged by ESD. Texas Instruments recommends that all integrated circuits be handled with appropriate precautions. Failure to observe proper handling and installation procedures can cause damage.

ESD damage can range from subtle performance degradation to complete device failure. Precision integrated circuits may be more susceptible to damage because very small parametric changes could cause the device not to meet its published specifications.

### 12.6 Glossary

[SLYZ022](#) — *TI Glossary*.

This glossary lists and explains terms, acronyms, and definitions.

## 13 Mechanical, Packaging, and Orderable Information

The following pages include mechanical, packaging, and orderable information. This information is the most current data available for the designated devices. This data is subject to change without notice and revision of this document. For browser-based versions of this data sheet, refer to the left-hand navigation.

**PACKAGING INFORMATION**

Orderable Device	Status (1)	Package Type	Package Drawing	Pins	Package Qty	Eco Plan (2)	Lead/Ball Finish (6)	MSL Peak Temp (3)	Op Temp (°C)	Device Marking (4/5)	Samples
BQ25150YFPR	ACTIVE	DSBGA	YFP	20	3000	Green (RoHS & no Sb/Br)	SNAGCU	Level-1-260C-UNLIM	-40 to 85	BQ25150	<a href="#">Samples</a>
BQ25150YFPT	ACTIVE	DSBGA	YFP	20	250	Green (RoHS & no Sb/Br)	SNAGCU	Level-1-260C-UNLIM	-40 to 85	BQ25150	<a href="#">Samples</a>

(1) The marketing status values are defined as follows:

**ACTIVE:** Product device recommended for new designs.

**LIFEBUY:** TI has announced that the device will be discontinued, and a lifetime-buy period is in effect.

**NRND:** Not recommended for new designs. Device is in production to support existing customers, but TI does not recommend using this part in a new design.

**PREVIEW:** Device has been announced but is not in production. Samples may or may not be available.

**OBSELETE:** TI has discontinued the production of the device.

(2) **RoHS:** TI defines "RoHS" to mean semiconductor products that are compliant with the current EU RoHS requirements for all 10 RoHS substances, including the requirement that RoHS substance do not exceed 0.1% by weight in homogeneous materials. Where designed to be soldered at high temperatures, "RoHS" products are suitable for use in specified lead-free processes. TI may reference these types of products as "Pb-Free".

**RoHS Exempt:** TI defines "RoHS Exempt" to mean products that contain lead but are compliant with EU RoHS pursuant to a specific EU RoHS exemption.

**Green:** TI defines "Green" to mean the content of Chlorine (Cl) and Bromine (Br) based flame retardants meet JS709B low halogen requirements of <=1000ppm threshold. Antimony trioxide based flame retardants must also meet the <=1000ppm threshold requirement.

(3) MSL, Peak Temp. - The Moisture Sensitivity Level rating according to the JEDEC industry standard classifications, and peak solder temperature.

(4) There may be additional marking, which relates to the logo, the lot trace code information, or the environmental category on the device.

(5) Multiple Device Markings will be inside parentheses. Only one Device Marking contained in parentheses and separated by a "-" will appear on a device. If a line is indented then it is a continuation of the previous line and the two combined represent the entire Device Marking for that device.

(6) Lead/Ball Finish - Orderable Devices may have multiple material finish options. Finish options are separated by a vertical ruled line. Lead/Ball Finish values may wrap to two lines if the finish value exceeds the maximum column width.

**Important Information and Disclaimer:**The information provided on this page represents TI's knowledge and belief as of the date that it is provided. TI bases its knowledge and belief on information provided by third parties, and makes no representation or warranty as to the accuracy of such information. Efforts are underway to better integrate information from third parties. TI has taken and continues to take reasonable steps to provide representative and accurate information but may not have conducted destructive testing or chemical analysis on incoming materials and chemicals. TI and TI suppliers consider certain information to be proprietary, and thus CAS numbers and other limited information may not be available for release.

In no event shall TI's liability arising out of such information exceed the total purchase price of the TI part(s) at issue in this document sold by TI to Customer on an annual basis.



## TAPE AND REEL INFORMATION



### QUADRANT ASSIGNMENTS FOR PIN 1 ORIENTATION IN TAPE



\*All dimensions are nominal

Device	Package Type	Package Drawing	Pins	SPQ	Reel Diameter (mm)	Reel Width W1 (mm)	A0 (mm)	B0 (mm)	K0 (mm)	P1 (mm)	W (mm)	Pin1 Quadrant
BQ25150YFPR	DSBGA	YFP	20	3000	180.0	8.4	1.77	2.17	0.62	4.0	8.0	Q1
BQ25150YFPT	DSBGA	YFP	20	250	180.0	8.4	1.77	2.17	0.62	4.0	8.0	Q1

**TAPE AND REEL BOX DIMENSIONS**

\*All dimensions are nominal

Device	Package Type	Package Drawing	Pins	SPQ	Length (mm)	Width (mm)	Height (mm)
BQ25150YFPR	DSBGA	YFP	20	3000	182.0	182.0	20.0
BQ25150YFPT	DSBGA	YFP	20	250	182.0	182.0	20.0



YFP0020

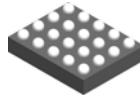

PACKAGE OUTLINE  
DSBGA - 0.5 mm max height

DIE SIZE BALL GRID ARRAY

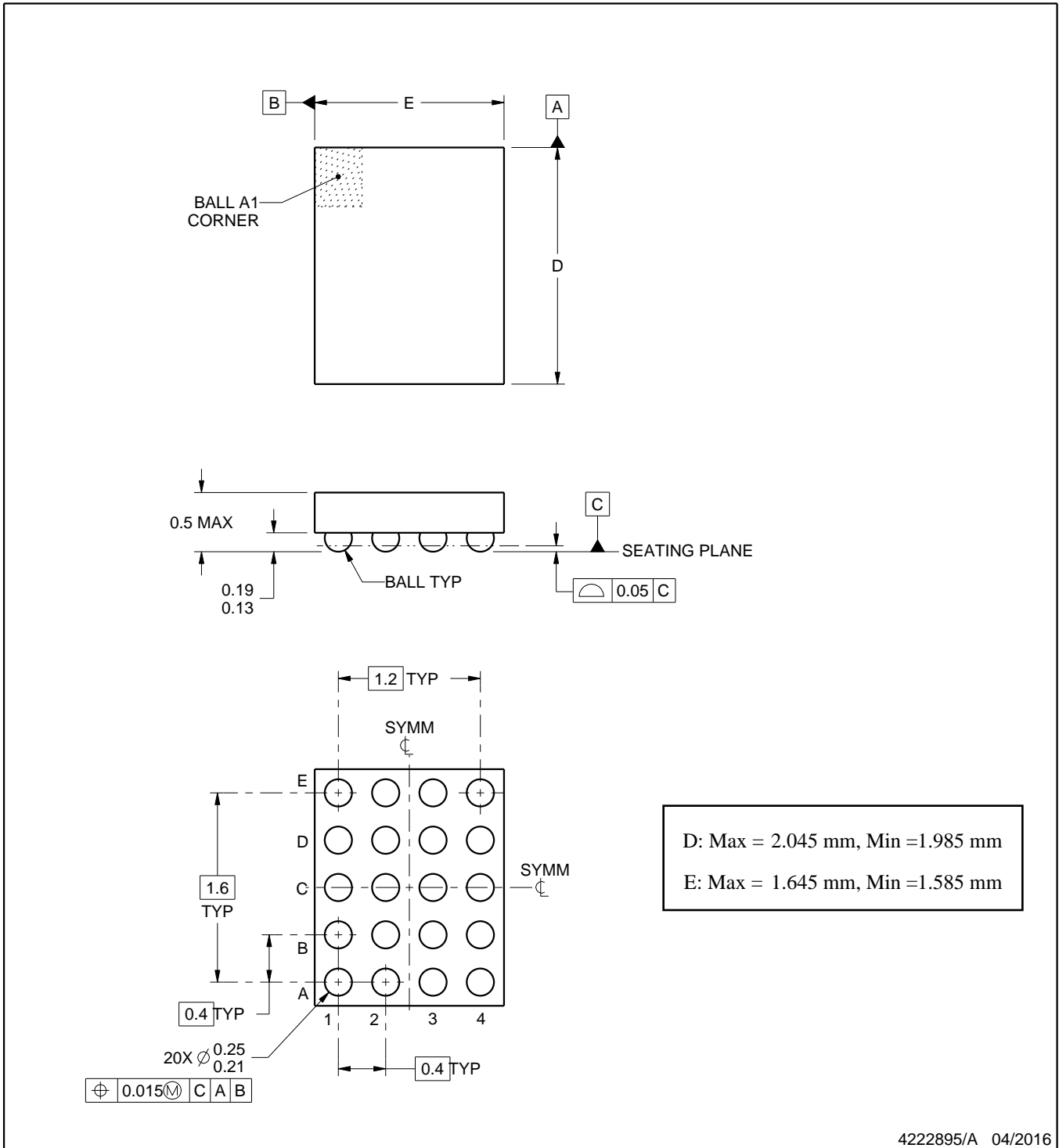

4222895/A 04/2016

NOTES:

1. All linear dimensions are in millimeters. Any dimensions in parenthesis are for reference only. Dimensioning and tolerancing per ASME Y14.5M.
2. This drawing is subject to change without notice.

# EXAMPLE BOARD LAYOUT

YFP0020

DSBGA - 0.5 mm max height

DIE SIZE BALL GRID ARRAY

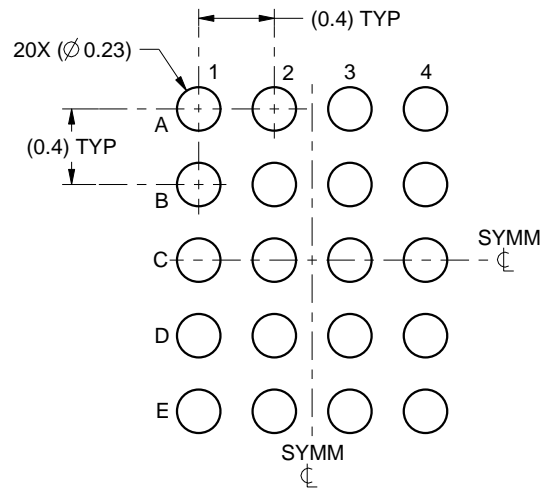

LAND PATTERN EXAMPLE  
SCALE:25X

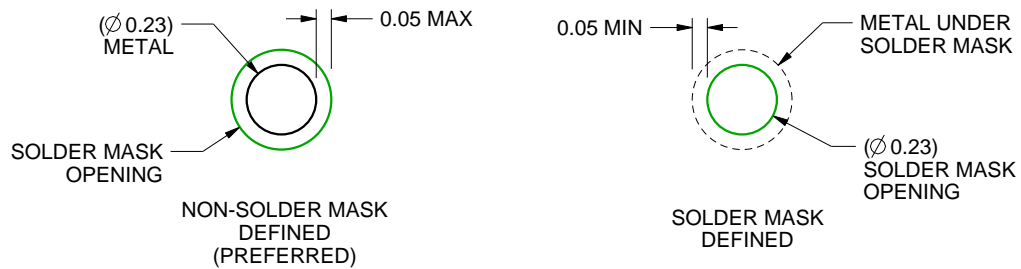

SOLDER MASK DETAILS  
NOT TO SCALE

4222895/A 04/2016

NOTES: (continued)

3. Final dimensions may vary due to manufacturing tolerance considerations and also routing constraints. For more information, see Texas Instruments literature number SNVA009 ([www.ti.com/lit/snva009](http://www.ti.com/lit/snva009)).

# EXAMPLE STENCIL DESIGN

YFP0020

DSBGA - 0.5 mm max height

DIE SIZE BALL GRID ARRAY

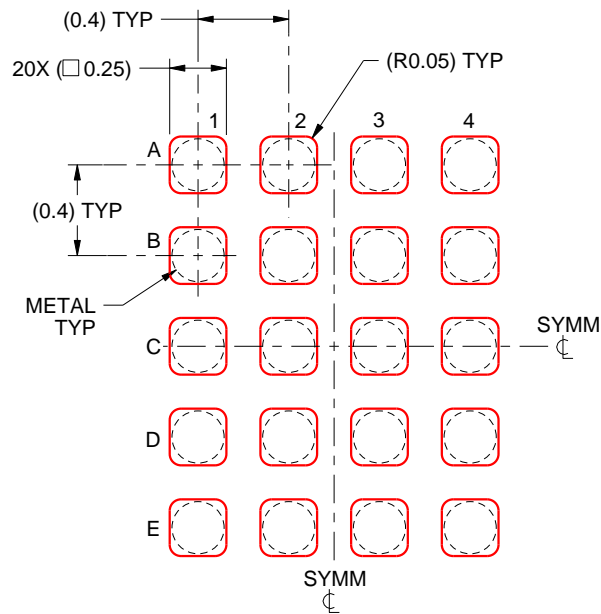

SOLDER PASTE EXAMPLE  
BASED ON 0.1 mm THICK STENCIL  
SCALE:30X

4222895/A 04/2016

NOTES: (continued)

4. Laser cutting apertures with trapezoidal walls and rounded corners may offer better paste release.

## IMPORTANT NOTICE AND DISCLAIMER

TI PROVIDES TECHNICAL AND RELIABILITY DATA (INCLUDING DATASHEETS), DESIGN RESOURCES (INCLUDING REFERENCE DESIGNS), APPLICATION OR OTHER DESIGN ADVICE, WEB TOOLS, SAFETY INFORMATION, AND OTHER RESOURCES "AS IS" AND WITH ALL FAULTS, AND DISCLAIMS ALL WARRANTIES, EXPRESS AND IMPLIED, INCLUDING WITHOUT LIMITATION ANY IMPLIED WARRANTIES OF MERCHANTABILITY, FITNESS FOR A PARTICULAR PURPOSE OR NON-INFRINGEMENT OF THIRD PARTY INTELLECTUAL PROPERTY RIGHTS.

These resources are intended for skilled developers designing with TI products. You are solely responsible for (1) selecting the appropriate TI products for your application, (2) designing, validating and testing your application, and (3) ensuring your application meets applicable standards, and any other safety, security, or other requirements. These resources are subject to change without notice. TI grants you permission to use these resources only for development of an application that uses the TI products described in the resource. Other reproduction and display of these resources is prohibited. No license is granted to any other TI intellectual property right or to any third party intellectual property right. TI disclaims responsibility for, and you will fully indemnify TI and its representatives against, any claims, damages, costs, losses, and liabilities arising out of your use of these resources.

TI's products are provided subject to TI's Terms of Sale ([www.ti.com/legal/termsofsale.html](http://www.ti.com/legal/termsofsale.html)) or other applicable terms available either on [ti.com](http://ti.com) or provided in conjunction with such TI products. TI's provision of these resources does not expand or otherwise alter TI's applicable warranties or warranty disclaimers for TI products.

Mailing Address: Texas Instruments, Post Office Box 655303, Dallas, Texas 75265  
Copyright © 2019, Texas Instruments Incorporated