



BGU8019

SiGe:C Low Noise Amplifier MMIC for GPS, GLONASS, Galileo and Compass

Rev. 3 — 18 January 2017

Product data sheet

1. Product profile

1.1 General description

The BGU8019 is, also known as the GPS1202M, a Low Noise Amplifier (LNA) for GNSS receiver applications, available in a small plastic 6-pin extremely thin leadless package. The BGU8019 requires one external matching inductor.

The BGU8019 adapts itself to the changing environment resulting from co-habitation of different radio systems in modern cellular handsets. It has been designed for low power consumption and optimal performance when jamming signals from co-existing cellular transmitters are present. At low jamming power levels it delivers 18.5 dB gain at a noise figure of 0.55 dB. During high jamming power levels, resulting for example from a cellular transmit burst, it temporarily increases its bias current to improve sensitivity.

1.2 Features and benefits

- Cover full GNSS L1 band, from 1559 MHz to 1610 MHz
- Noise figure (NF) = 0.55 dB
- Gain = 18.5 dB
- High input 1 dB compression point of -7 dBm
- High out of band IP_{3i} of 6 dBm
- Supply voltage 1.5 V to 3.1 V
- Self shielding package concept
- Integrated supply decoupling capacitor
- Optimized performance at a supply current of 4.6 mA
- Power-down mode current consumption < 1 μ A
- Integrated temperature stabilized bias for easy design
- Require only one input matching inductor
- Input and output DC decoupled
- ESD protection on all pins (HBM > 2 kV)
- Integrated matching for the output
- Available in 6-pins leadless package 1.1 mm \times 0.7 mm \times 0.37 mm; 0.4 mm pitch: SOT1232
- 180 GHz transit frequency - SiGe:C technology
- Moisture sensitivity level of 1



1.3 Applications

- LNA for GPS, GLONASS, Galileo and Compass (BeiDou) in smart phones, feature phones, tablet PCs, digital still cameras, digital video cameras, RF front-end modules, complete GNSS modules and personal health applications.

1.4 Quick reference data

Table 1. Quick reference data

$f = 1575 \text{ MHz}$; $V_{CC} = 2.85 \text{ V}$; $V_{I(ENABLE)} \geq 0.8 \text{ V}$; $P_i < -40 \text{ dBm}$; $T_{amb} = 25 \text{ }^\circ\text{C}$; input matched to $50 \text{ } \Omega$ using a 6.8 nH inductor, see [Figure 1](#); unless otherwise specified.

Symbol	Parameter	Conditions	Min	Typ	Max	Unit
V_{CC}	supply voltage		1.5	-	3.1	V
I_{CC}	supply current		-	4.6	-	mA
G_p	power gain	no jammer	-	18.5	-	dB
NF	noise figure	$P_i = -40 \text{ dBm}$, no jammer [1]	-	0.55	-	dB
$P_{i(1dB)}$	input power at 1 dB gain compression		-	-7	-	dBm
$IP3_i$	input third-order intercept point	[2]	-	6	-	dBm

[1] PCB losses are subtracted.

[2] $f_1 = 1713 \text{ MHz}$; $f_2 = 1851 \text{ MHz}$; $P_i = -20 \text{ dBm}$ at f_1 ; $P_i = -65 \text{ dBm}$ at f_2 .

2. Pinning information

Table 2. Pinning

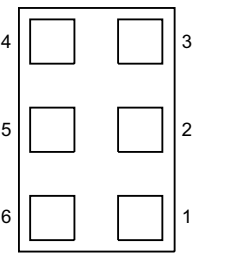
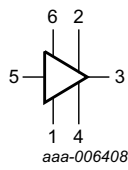
Pin	Description	Simplified outline	Graphic symbol
1	GND	 <p>Transparent top view</p>	 <p>aaa-006408</p>
2	V_{CC}		
3	RF_OUT		
4	GND_RF		
5	RF_IN		
6	ENABLE		

3. Ordering information

Table 3. Ordering information

Type number	Package		
	Name	Description	Version
BGU8019	XSON6	plastic extremely thin small outline package; no leads; 6 terminals; body $1.1 \times 0.7 \times 0.37 \text{ mm}$	SOT1232
OM7848	EVB	BGU8019 evaluation board, MMIC only	-
OM7849	EVB	BGU8019 evaluation board, front-end EVB	-

4. Marking

Table 4. Marking codes

Type number	Marking code
BGU8019	A

5. Limiting values

Table 5. Limiting values

In accordance with the Absolute Maximum Rating System (IEC 60134).

Absolute Maximum Ratings are given as Limiting Values of stress conditions during operation, that must not be exceeded under the worst probable conditions.

Symbol	Parameter	Conditions	Min	Max	Unit
V_{CC}	supply voltage	RF input AC coupled [1]	-0.5	+5.0	V
$V_{I(ENABLE)}$	input voltage on pin ENABLE	$V_{I(ENABLE)} < V_{CC} + 0.6$ V [1][2]	-0.5	+5.0	V
$V_{I(RF_IN)}$	input voltage on pin RF_IN	DC, $V_{I(RF_IN)} < V_{CC} + 0.6$ V [1][2][3]	-0.5	+5.0	V
$V_{I(RF_OUT)}$	input voltage on pin RF_OUT	DC, $V_{I(RF_OUT)} < V_{CC} + 0.6$ V [1][2][3]	-0.5	+5.0	V
P_i	input power	[1]	-	10	dBm
P_{tot}	total power dissipation	$T_{sp} \leq 130$ °C	-	55	mW
T_{stg}	storage temperature		-65	+150	°C
T_j	junction temperature		-	150	°C
V_{ESD}	electrostatic discharge voltage	Human Body Model (HBM) According to ANSI/ESDA/JEDEC standard JS-001	-	±2	kV
		Charged Device Model (CDM) According to JEDEC standard JESD22-C101C	-	±1	kV

- [1] Stressed with pulses of 200 ms in duration, with application circuit as in [Figure 1](#).
- [2] Warning: due to internal ESD diode protection, the applied DC voltage shall not exceed $V_{CC} + 0.6$ V and shall not exceed 5.0 V in order to avoid excess current.
- [3] The RF input and RF output are AC coupled through internal DC blocking capacitors.

6. Recommended operating conditions

Table 6. Operating conditions

Symbol	Parameter	Conditions	Min	Typ	Max	Unit
V_{CC}	supply voltage		1.5	-	3.1	V
T_{amb}	ambient temperature		-40	+25	+85	°C
$V_{I(ENABLE)}$	input voltage on pin ENABLE	OFF state	-	-	0.3	V
		ON state	0.8	-	-	V

7. Thermal characteristics

Table 7. Thermal characteristics

Symbol	Parameter	Conditions	Typ	Unit
$R_{th(j-sp)}$	thermal resistance from junction to solder point		225	K/W

8. Characteristics

Table 8. Characteristics at $V_{CC} = 1.8$ V

$f = 1575$ MHz; $V_{CC} = 1.8$ V; $V_{I(ENABLE)} \geq 0.8$ V; $P_i < -40$ dBm; $T_{amb} = 25$ °C; input matched to 50Ω using a 6.8 nH inductor, see [Figure 1](#); unless otherwise specified.

Symbol	Parameter	Conditions	Min	Typ	Max	Unit
I_{CC}	supply current	$V_{I(ENABLE)} \geq 0.8$ V				
		$P_i < -40$ dBm	-	4.4	-	mA
		$P_i = -20$ dBm	-	9	-	mA
		$V_{I(ENABLE)} \leq 0.3$ V	-	-	1	μ A
G_p	power gain	no jammer	-	18	-	dB
		$P_{jam} = -20$ dBm; $f_{jam} = 850$ MHz	-	20	-	dB
		$P_{jam} = -20$ dBm; $f_{jam} = 1850$ MHz	-	20	-	dB
RL_{in}	input return loss	$P_i < -40$ dBm	-	12	-	dB
		$P_i = -20$ dBm	-	20	-	dB
RL_{out}	output return loss	$P_i < -40$ dBm	-	13	-	dB
		$P_i = -20$ dBm	-	12	-	dB
ISL	isolation		-	30	-	dB
NF	noise figure	$P_i = -40$ dBm, no jammer [1]	-	0.55	-	dB
		$P_i = -40$ dBm, no jammer [2]	-	0.60	-	dB
		$P_{jam} = -20$ dBm; $f_{jam} = 850$ MHz [2]	-	0.9	-	dB
		$P_{jam} = -20$ dBm; $f_{jam} = 1850$ MHz [2]	-	1.3	-	dB
$P_{i(1dB)}$	input power at 1 dB gain compression		-	-10	-	dBm
$IP3_i$	input third-order intercept point		[3]	2	-	dBm
IMD3	third-order intermodulation distortion	measured at output pin [3]	-	-89	-	dBm
t_{on}	turn-on time	time from $V_{I(ENABLE)}$ ON, to 90 % of the gain	-	-	2	μ s
t_{off}	turn-off time	time from $V_{I(ENABLE)}$ OFF, to 10 % of the gain	-	-	1	μ s

[1] PCB losses are subtracted

[2] Including PCB losses

[3] $f_1 = 1713$ MHz; $f_2 = 1851$ MHz; $P_i = -20$ dBm at f_1 ; $P_i = -65$ dBm at f_2 .

Table 9. Characteristics at $V_{CC} = 2.85$ V

$f = 1575$ MHz; $V_{CC} = 2.85$ V; $V_{I(ENABLE)} \geq 0.8$ V; $P_i < -40$ dBm; $T_{amb} = 25$ °C; input matched to 50Ω using a 6.8 nH inductor, see [Figure 1](#); unless otherwise specified.

Symbol	Parameter	Conditions	Min	Typ	Max	Unit
I _{CC}	supply current	$V_{I(ENABLE)} \geq 0.8$ V				
		$P_i < -40$ dBm	-	4.6	-	mA
		$P_i = -20$ dBm	-	10	-	mA
		$V_{I(ENABLE)} \leq 0.3$ V	-	-	1	μ A
G _p	power gain	no jammer	-	18.5	-	dB
		$P_{jam} = -20$ dBm; $f_{jam} = 850$ MHz	-	20.0	-	dB
		$P_{jam} = -20$ dBm; $f_{jam} = 1850$ MHz	-	20.5	-	dB
RL _{in}	input return loss	$P_i < -40$ dBm	-	13	-	dB
		$P_i = -20$ dBm	-	22	-	dB
RL _{out}	output return loss	$P_i < -40$ dBm	-	13	-	dB
		$P_i = -20$ dBm	-	12	-	dB
ISL	isolation		-	30	-	dB
NF	noise figure	$P_i = -40$ dBm, no jammer [1]	-	0.55	-	dB
		$P_i = -40$ dBm, no jammer [2]	-	0.60	-	dB
		$P_{jam} = -20$ dBm; $f_{jam} = 850$ MHz [2]	-	0.9	-	dB
		$P_{jam} = -20$ dBm; $f_{jam} = 1850$ MHz [2]	-	1.3	-	dB
P _{i(1dB)}	input power at 1 dB gain compression		-	-7	-	dBm
IP _{3i}	input third-order intercept point	[3]	-	6	-	dBm
IMD ₃	third-order intermodulation distortion	measured at output pin [3]	-	-96	-	dBm
t _{on}	turn-on time	time from $V_{I(ENABLE)}$ ON, to 90 % of the gain	-	-	2	μ s
t _{off}	turn-off time	time from $V_{I(ENABLE)}$ OFF, to 10 % of the gain	-	-	1	μ s

[1] PCB losses are subtracted

[2] Including PCB losses

[3] $f_1 = 1713$ MHz; $f_2 = 1851$ MHz; $P_i = -20$ dBm at f_1 ; $P_i = -65$ dBm at f_2 .

9. Application information

9.1 GNSS LNA

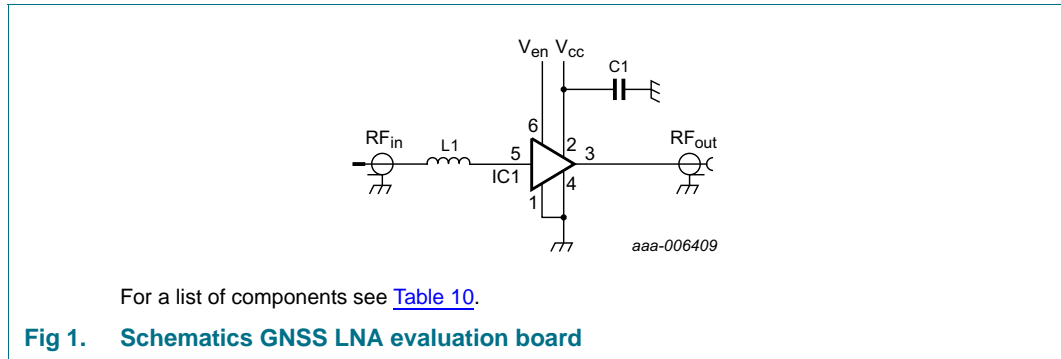
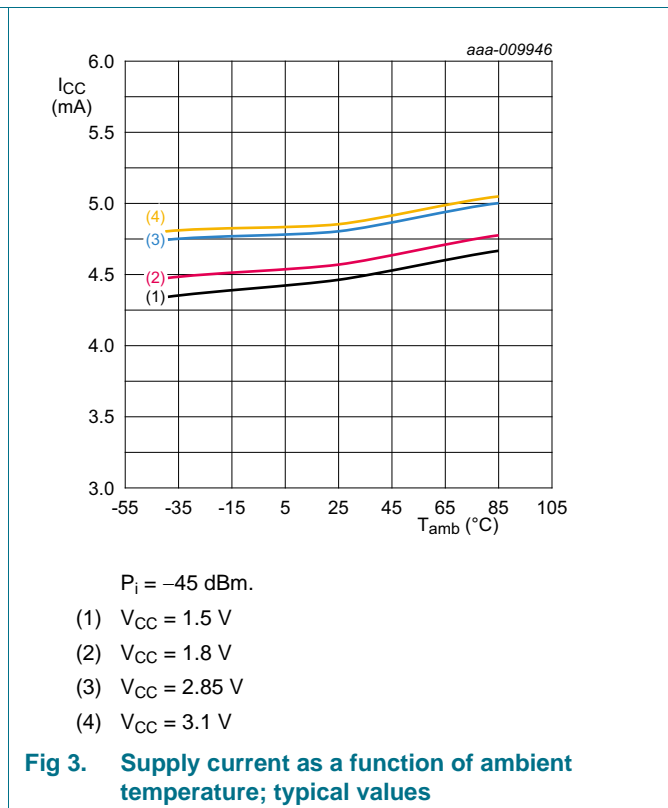
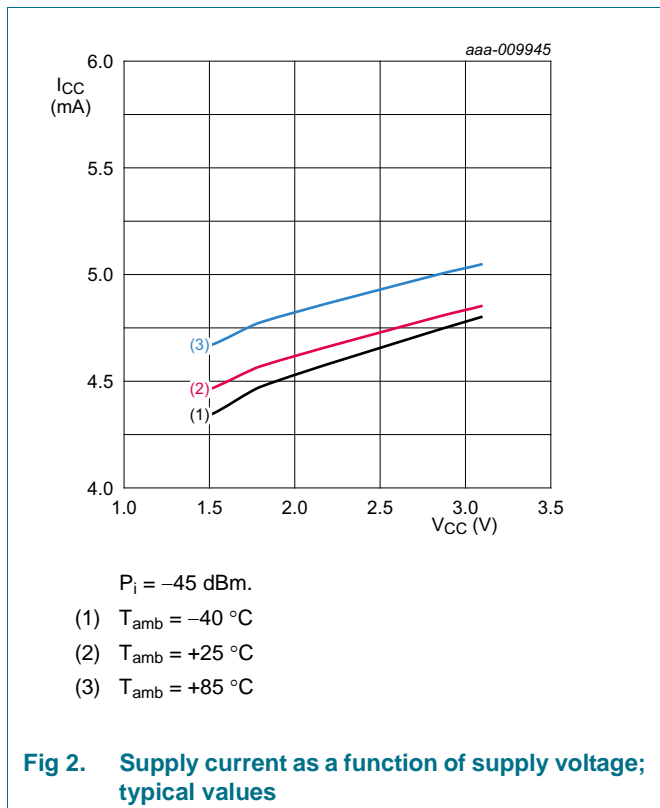

Table 10. List of components

For schematics see [Figure 1](#).

Component	Description	Value	Remarks
C1	decoupling capacitor	1 nF	to suppress power supply noise
IC1	BGU8019	-	NXP
L1	high quality matching inductor	6.8 nH	Murata LQW15A

9.2 Graphs



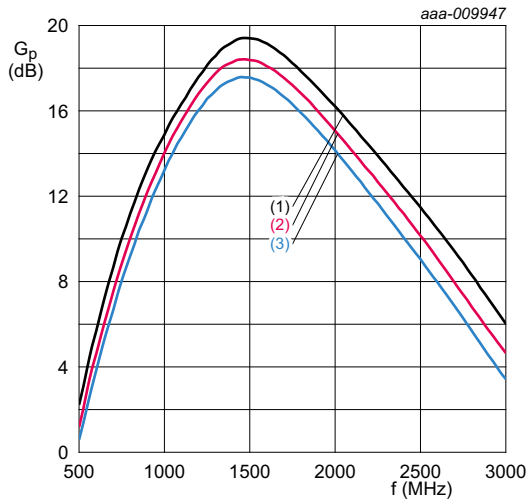

$P_i = -45 \text{ dBm}; V_{CC} = 1.8 \text{ V}.$
 (1) $T_{amb} = -40 \text{ }^\circ\text{C}$
 (2) $T_{amb} = +25 \text{ }^\circ\text{C}$
 (3) $T_{amb} = +85 \text{ }^\circ\text{C}$

Fig 4. Power gain as a function of frequency; typical values

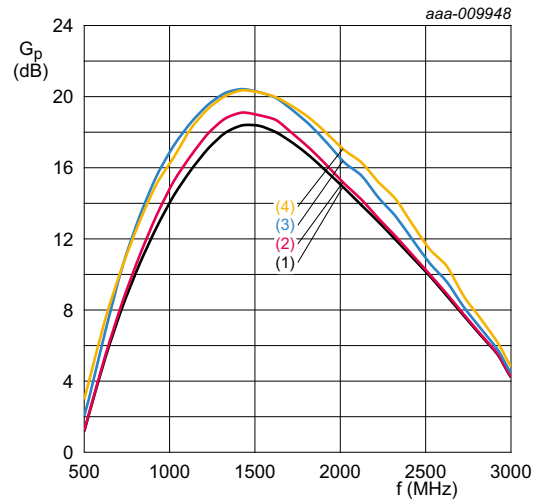

$T_{amb} = 25 \text{ }^\circ\text{C}; V_{CC} = 1.8 \text{ V}.$
 (1) $P_i = -45 \text{ dBm}$
 (2) $P_i = -30 \text{ dBm}$
 (3) $P_i = -20 \text{ dBm}$
 (4) $P_i = -15 \text{ dBm}$

Fig 5. Power gain as a function of frequency; typical values

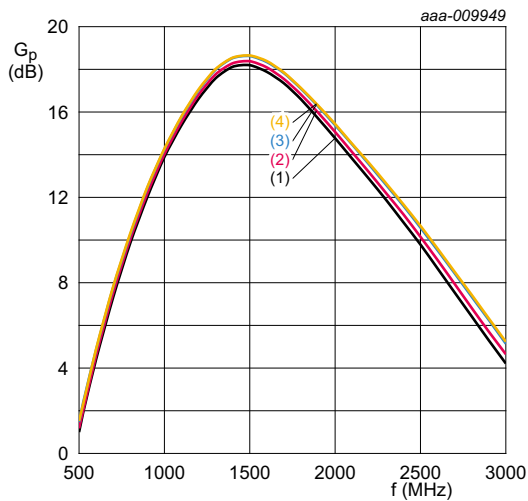

$P_i = -45 \text{ dBm}; T_{amb} = 25 \text{ }^\circ\text{C}.$
 (1) $V_{CC} = 1.5 \text{ V}$
 (2) $V_{CC} = 1.8 \text{ V}$
 (3) $V_{CC} = 2.85 \text{ V}$
 (4) $V_{CC} = 3.1 \text{ V}$

Fig 6. Power gain as a function of frequency; typical values

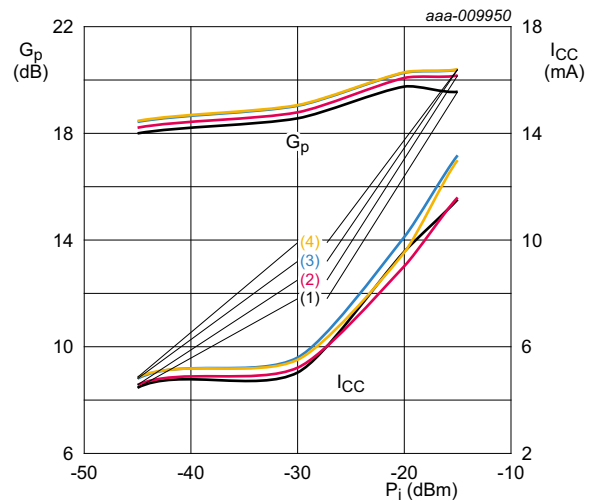

$f = 1575 \text{ MHz}; T_{amb} = 25 \text{ }^\circ\text{C}.$
 (1) $V_{CC} = 1.5 \text{ V}$
 (2) $V_{CC} = 1.8 \text{ V}$
 (3) $V_{CC} = 2.85 \text{ V}$
 (4) $V_{CC} = 3.1 \text{ V}$

Fig 7. Power gain and supply current as function of input power; typical values

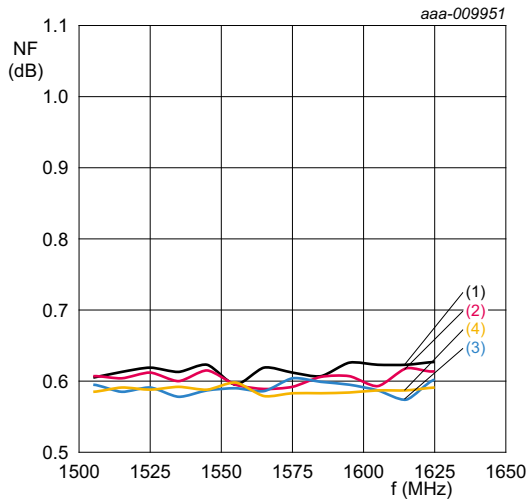

$T_{amb} = 25\text{ }^{\circ}\text{C}$; no jammer, including PCB losses.

- (1) $V_{CC} = 1.5\text{ V}$
- (2) $V_{CC} = 1.8\text{ V}$
- (3) $V_{CC} = 2.85\text{ V}$
- (4) $V_{CC} = 3.1\text{ V}$

Fig 8. Noise figure as a function of frequency; typical values

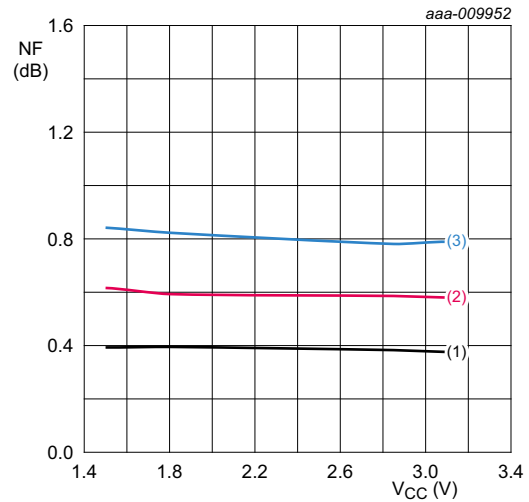

$f = 1575\text{ MHz}$; no jammer, including PCB losses.

- (1) $T_{amb} = -40\text{ }^{\circ}\text{C}$
- (2) $T_{amb} = +25\text{ }^{\circ}\text{C}$
- (3) $T_{amb} = +85\text{ }^{\circ}\text{C}$

Fig 9. Noise figure as a function of supply voltage; typical values

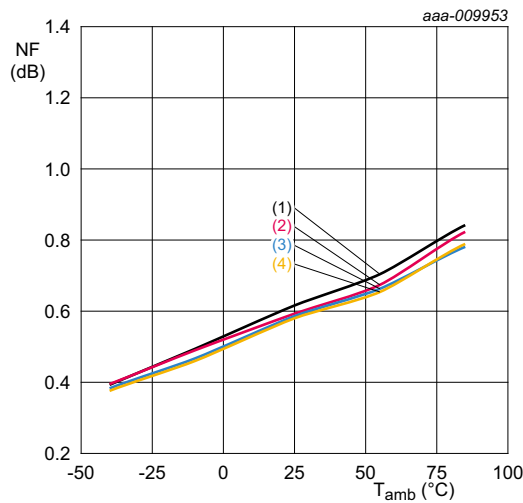

$f = 1575\text{ MHz}$; no jammer, including PCB losses.

- (1) $V_{CC} = 1.5\text{ V}$
- (2) $V_{CC} = 1.8\text{ V}$
- (3) $V_{CC} = 2.85\text{ V}$
- (4) $V_{CC} = 3.1\text{ V}$

Fig 10. Noise figure as a function of ambient temperature; typical values

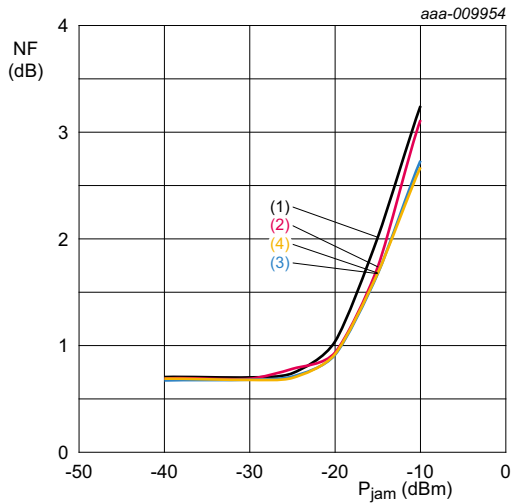

$f_{jam} = 850 \text{ MHz}$; $T_{amb} = 25 \text{ }^\circ\text{C}$; $f = 1575 \text{ MHz}$;
including PCB losses.

- (1) $V_{CC} = 1.5 \text{ V}$
- (2) $V_{CC} = 1.8 \text{ V}$
- (3) $V_{CC} = 2.85 \text{ V}$
- (4) $V_{CC} = 3.1 \text{ V}$

Fig 11. Noise figure as a function of jamming power; typical values

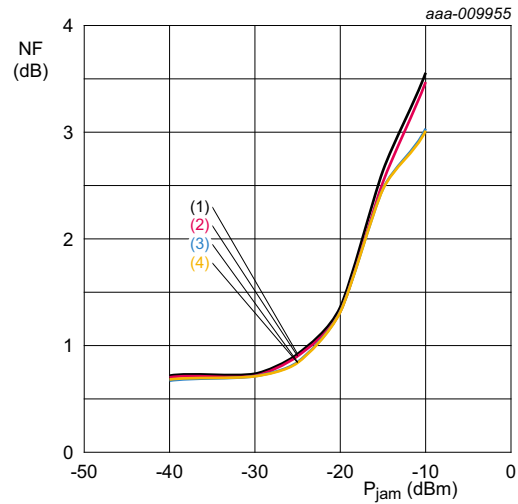

$f_{jam} = 1850 \text{ MHz}$; $T_{amb} = 25 \text{ }^\circ\text{C}$; $f = 1575 \text{ MHz}$;
including PCB losses.

- (1) $V_{CC} = 1.5 \text{ V}$
- (2) $V_{CC} = 1.8 \text{ V}$
- (3) $V_{CC} = 2.85 \text{ V}$
- (4) $V_{CC} = 3.1 \text{ V}$

Fig 12. Noise figure as a function of jamming power; typical values

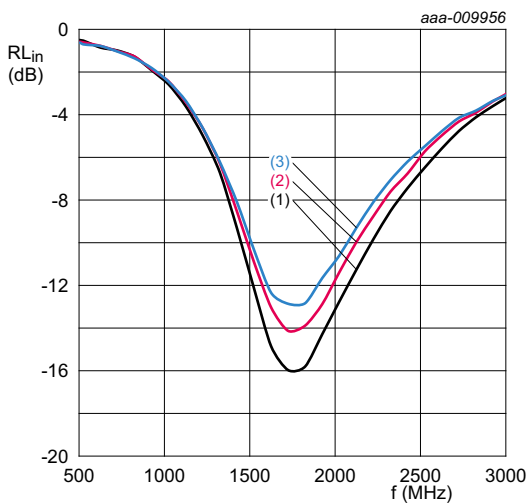

$P_i = -45 \text{ dBm}$; $V_{CC} = 1.8 \text{ V}$.

- (1) $T_{amb} = -40 \text{ }^\circ\text{C}$
- (2) $T_{amb} = +25 \text{ }^\circ\text{C}$
- (3) $T_{amb} = +85 \text{ }^\circ\text{C}$

Fig 13. Input return loss as a function of frequency; typical values

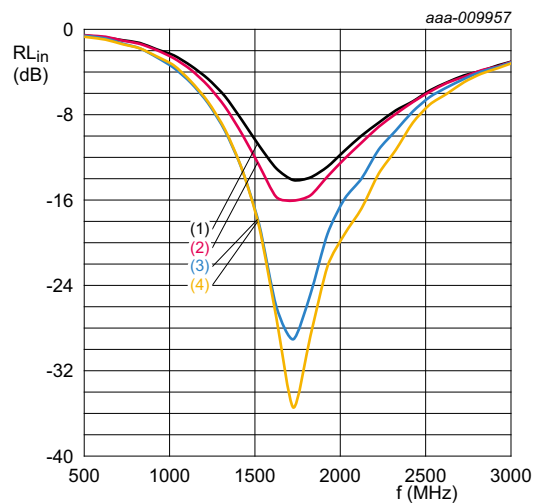

$T_{amb} = 25 \text{ }^\circ\text{C}$; $V_{CC} = 1.8 \text{ V}$.

- (1) $P_i = -45 \text{ dBm}$
- (2) $P_i = -30 \text{ dBm}$
- (3) $P_i = -20 \text{ dBm}$
- (4) $P_i = -15 \text{ dBm}$

Fig 14. Input return loss as a function of frequency; typical values

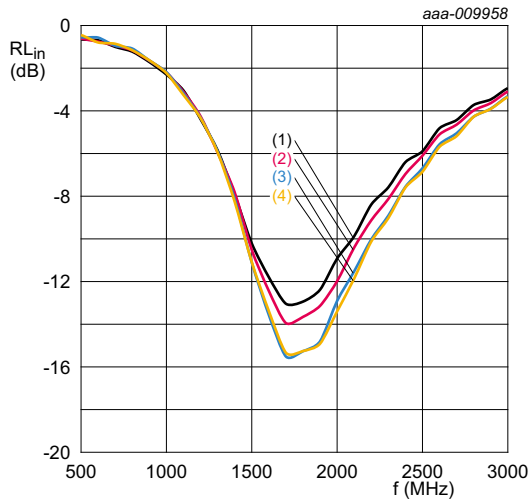

$P_i = -45 \text{ dBm}; T_{\text{amb}} = 25 \text{ }^\circ\text{C}.$
 (1) $V_{\text{CC}} = 1.5 \text{ V}$
 (2) $V_{\text{CC}} = 1.8 \text{ V}$
 (3) $V_{\text{CC}} = 2.85 \text{ V}$
 (4) $V_{\text{CC}} = 3.1 \text{ V}$

Fig 15. Input return loss as a function of frequency; typical values

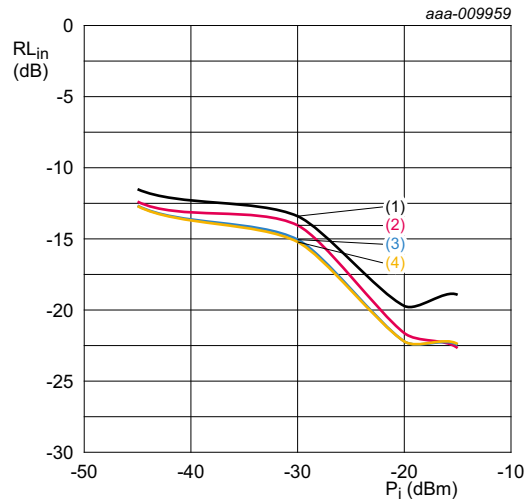

$f = 1575 \text{ MHz}; T_{\text{amb}} = 25 \text{ }^\circ\text{C}.$
 (1) $V_{\text{CC}} = 1.5 \text{ V}$
 (2) $V_{\text{CC}} = 1.8 \text{ V}$
 (3) $V_{\text{CC}} = 2.85 \text{ V}$
 (4) $V_{\text{CC}} = 3.1 \text{ V}$

Fig 16. Input return loss as a function of input power; typical values

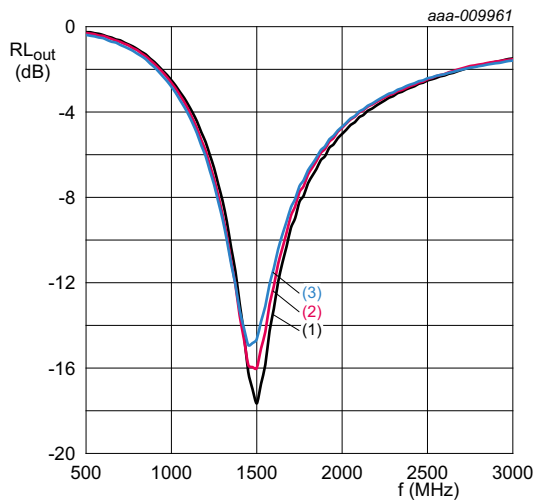

$P_i = -45 \text{ dBm}; V_{\text{CC}} = 1.8 \text{ V}.$
 (1) $T_{\text{amb}} = -40 \text{ }^\circ\text{C}$
 (2) $T_{\text{amb}} = +25 \text{ }^\circ\text{C}$
 (3) $T_{\text{amb}} = +85 \text{ }^\circ\text{C}$

Fig 17. Output return loss as a function of frequency; typical values

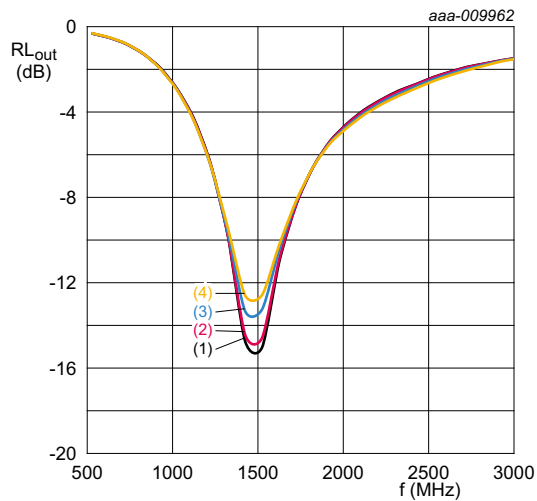

$T_{\text{amb}} = 25 \text{ }^\circ\text{C}; V_{\text{CC}} = 1.8 \text{ V}.$
 (1) $P_i = -45 \text{ dBm}$
 (2) $P_i = -30 \text{ dBm}$
 (3) $P_i = -20 \text{ dBm}$
 (4) $P_i = -15 \text{ dBm}$

Fig 18. Output return loss as a function of frequency; typical values

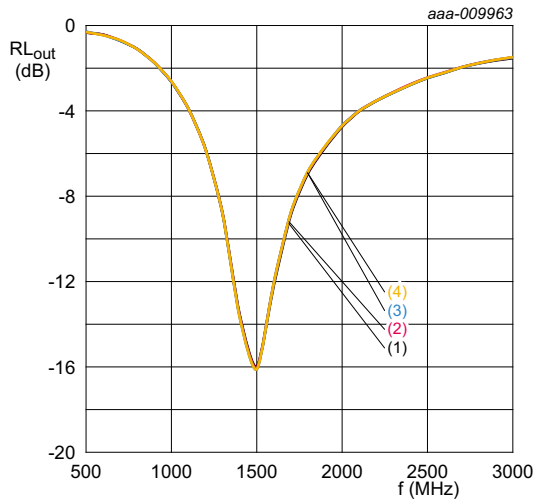

$P_i = -45$ dBm; $T_{amb} = 25$ °C.
 (1) $V_{CC} = 1.5$ V
 (2) $V_{CC} = 1.8$ V
 (3) $V_{CC} = 2.85$ V
 (4) $V_{CC} = 3.1$ V

Fig 19. Output return loss as a function of frequency; typical values

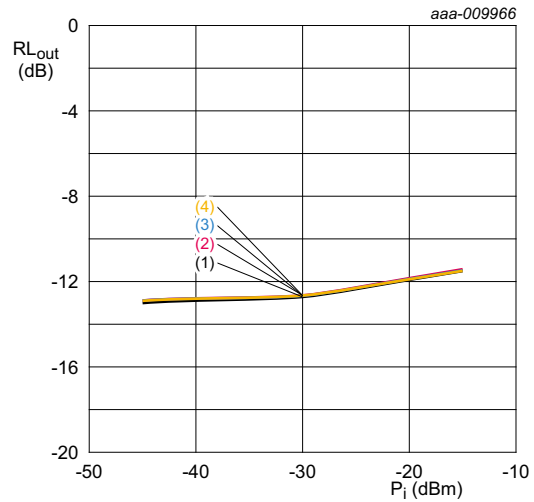

$f = 1575$ MHz; $T_{amb} = 25$ °C.
 (1) $V_{CC} = 1.5$ V
 (2) $V_{CC} = 1.8$ V
 (3) $V_{CC} = 2.85$ V
 (4) $V_{CC} = 3.1$ V

Fig 20. Output return loss as a function of input power; typical values

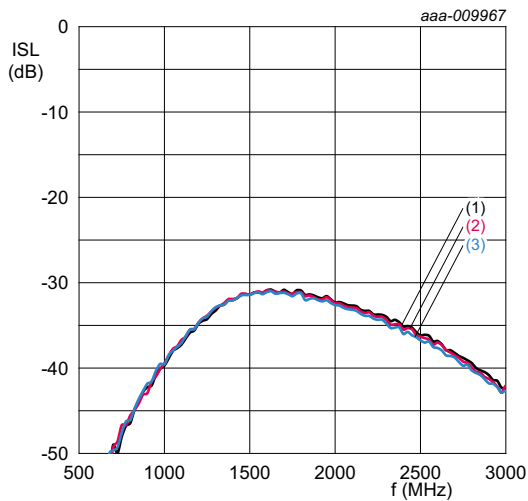

$P_i = -45$ dBm; $V_{CC} = 1.8$ V.
 (1) $T_{amb} = -40$ °C
 (2) $T_{amb} = +25$ °C
 (3) $T_{amb} = +85$ °C

Fig 21. Isolation as a function of frequency; typical values

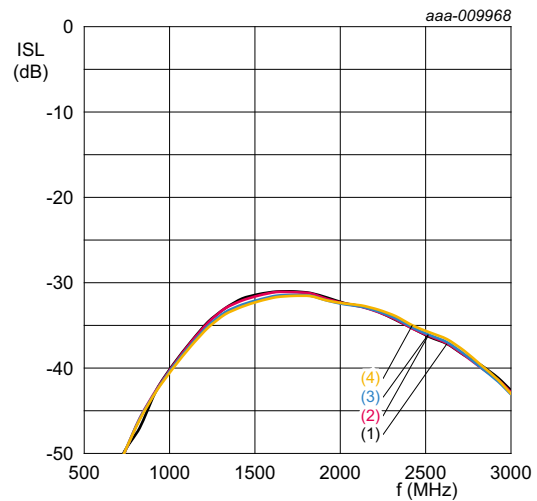

$T_{amb} = 25$ °C; $V_{CC} = 1.8$ V.
 (1) $P_i = -45$ dBm
 (2) $P_i = -30$ dBm
 (3) $P_i = -20$ dBm
 (4) $P_i = -15$ dBm

Fig 22. Isolation as a function of frequency; typical values

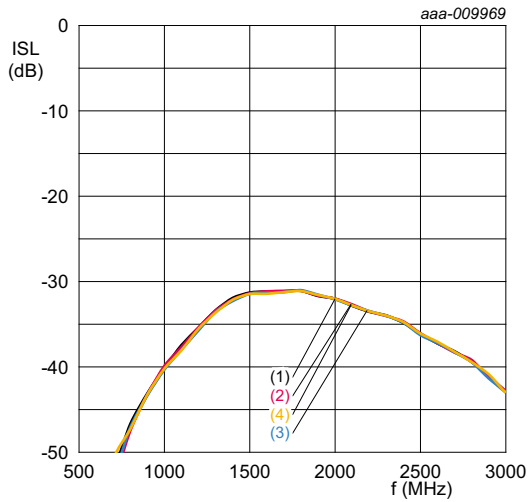

$P_i = -45 \text{ dBm}$; $T_{\text{amb}} = 25 \text{ }^\circ\text{C}$.
 (1) $V_{\text{CC}} = 1.5 \text{ V}$
 (2) $V_{\text{CC}} = 1.8 \text{ V}$
 (3) $V_{\text{CC}} = 2.85 \text{ V}$
 (4) $V_{\text{CC}} = 3.1 \text{ V}$

Fig 23. Isolation as a function of frequency; typical values

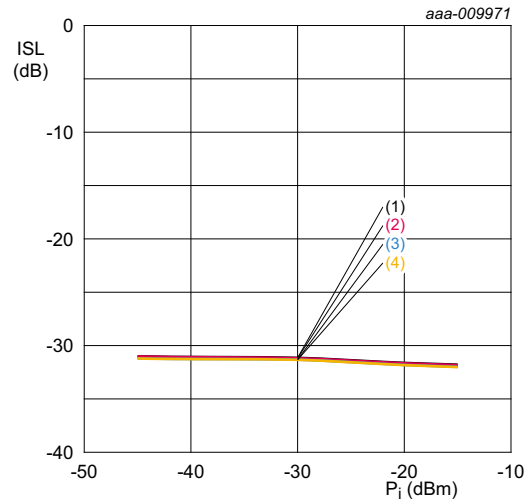

$f = 1575 \text{ MHz}$; $T_{\text{amb}} = 25 \text{ }^\circ\text{C}$.
 (1) $V_{\text{CC}} = 1.5 \text{ V}$
 (2) $V_{\text{CC}} = 1.8 \text{ V}$
 (3) $V_{\text{CC}} = 2.85 \text{ V}$
 (4) $V_{\text{CC}} = 3.1 \text{ V}$

Fig 24. Isolation as a function of input power; typical values

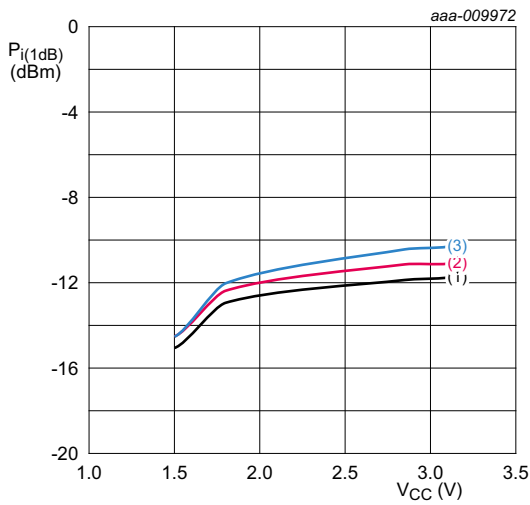

$f = 850 \text{ MHz}$.
 (1) $T_{\text{amb}} = -40 \text{ }^\circ\text{C}$
 (2) $T_{\text{amb}} = +25 \text{ }^\circ\text{C}$
 (3) $T_{\text{amb}} = +85 \text{ }^\circ\text{C}$

Fig 25. Input power at 1 dB gain compression as a function of supply voltage; typical values

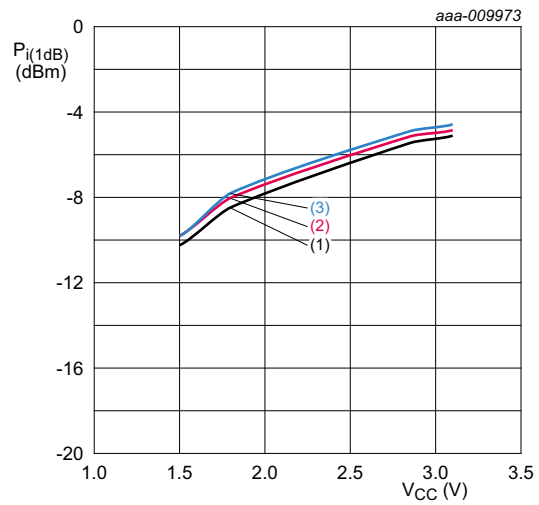

$f = 1850 \text{ MHz}$.
 (1) $T_{\text{amb}} = -40 \text{ }^\circ\text{C}$
 (2) $T_{\text{amb}} = +25 \text{ }^\circ\text{C}$
 (3) $T_{\text{amb}} = +85 \text{ }^\circ\text{C}$

Fig 26. Input power at 1 dB gain compression as a function of supply voltage; typical values

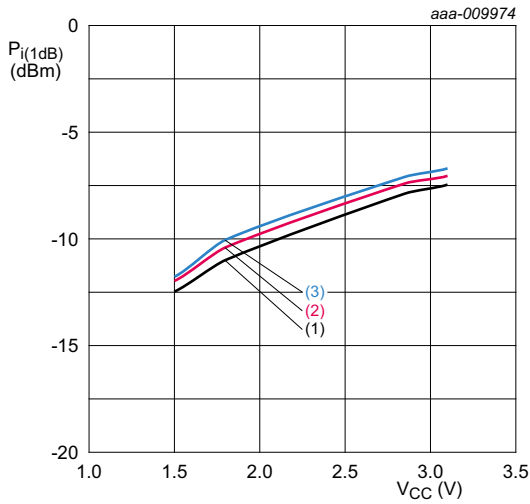

$f = 1575 \text{ MHz}$.
 (1) $T_{\text{amb}} = -40 \text{ }^\circ\text{C}$
 (2) $T_{\text{amb}} = +25 \text{ }^\circ\text{C}$
 (3) $T_{\text{amb}} = +85 \text{ }^\circ\text{C}$

Fig 27. Input power at 1 dB gain compression as a function of supply voltage; typical values

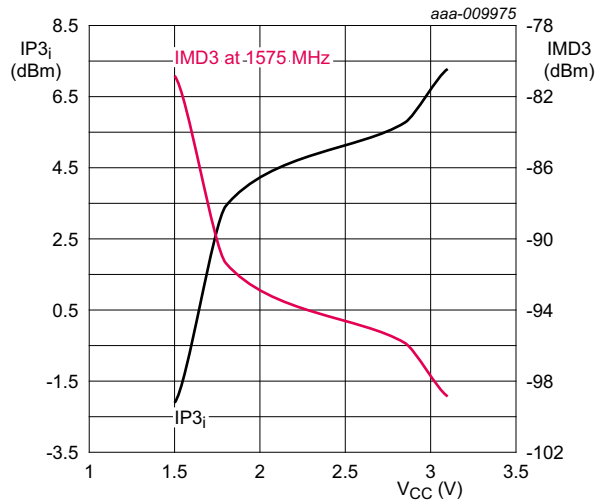

$f_1 = 1713 \text{ MHz}$; $f_2 = 1851 \text{ MHz}$; $P_i = -20 \text{ dBm}$ at f_1 ;
 $P_i = -65 \text{ dBm}$ at f_2 ; $T_{\text{amb}} = 25 \text{ }^\circ\text{C}$.

Fig 28. Input third order intercept point and third order intermodulation distortion as function of supply voltage; typical values

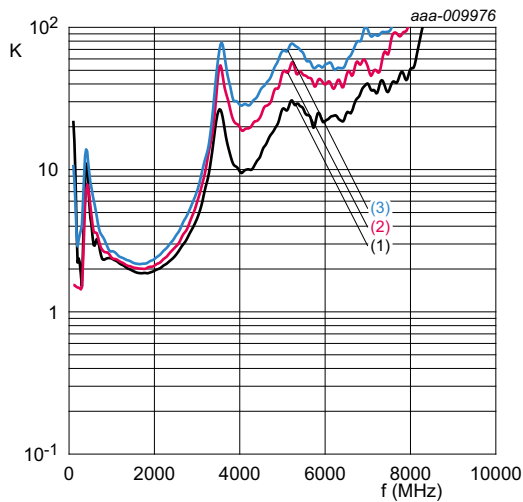

$P_i = -45 \text{ dBm}$; $V_{\text{CC}} = 1.8 \text{ V}$.
 (1) $T_{\text{amb}} = -40 \text{ }^\circ\text{C}$
 (2) $T_{\text{amb}} = +25 \text{ }^\circ\text{C}$
 (3) $T_{\text{amb}} = +85 \text{ }^\circ\text{C}$

Fig 29. Rollett stability factor as a function of frequency; typical values

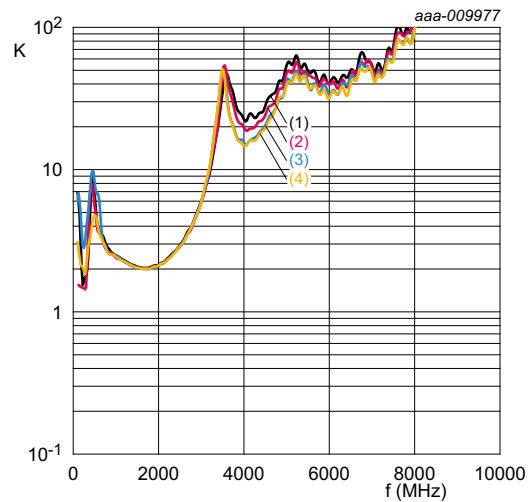

$P_i = -45 \text{ dBm}$; $T_{\text{amb}} = 25 \text{ }^\circ\text{C}$.
 (1) $V_{\text{CC}} = 1.5 \text{ V}$
 (2) $V_{\text{CC}} = 1.8 \text{ V}$
 (3) $V_{\text{CC}} = 2.85 \text{ V}$
 (4) $V_{\text{CC}} = 3.1 \text{ V}$

Fig 30. Rollett stability factor as a function of frequency; typical values

10. Package outline

XSON6: plastic extremely thin small outline package; no leads; 6 terminals; body 1.1 x 0.7 x 0.37 mm

SOT1232

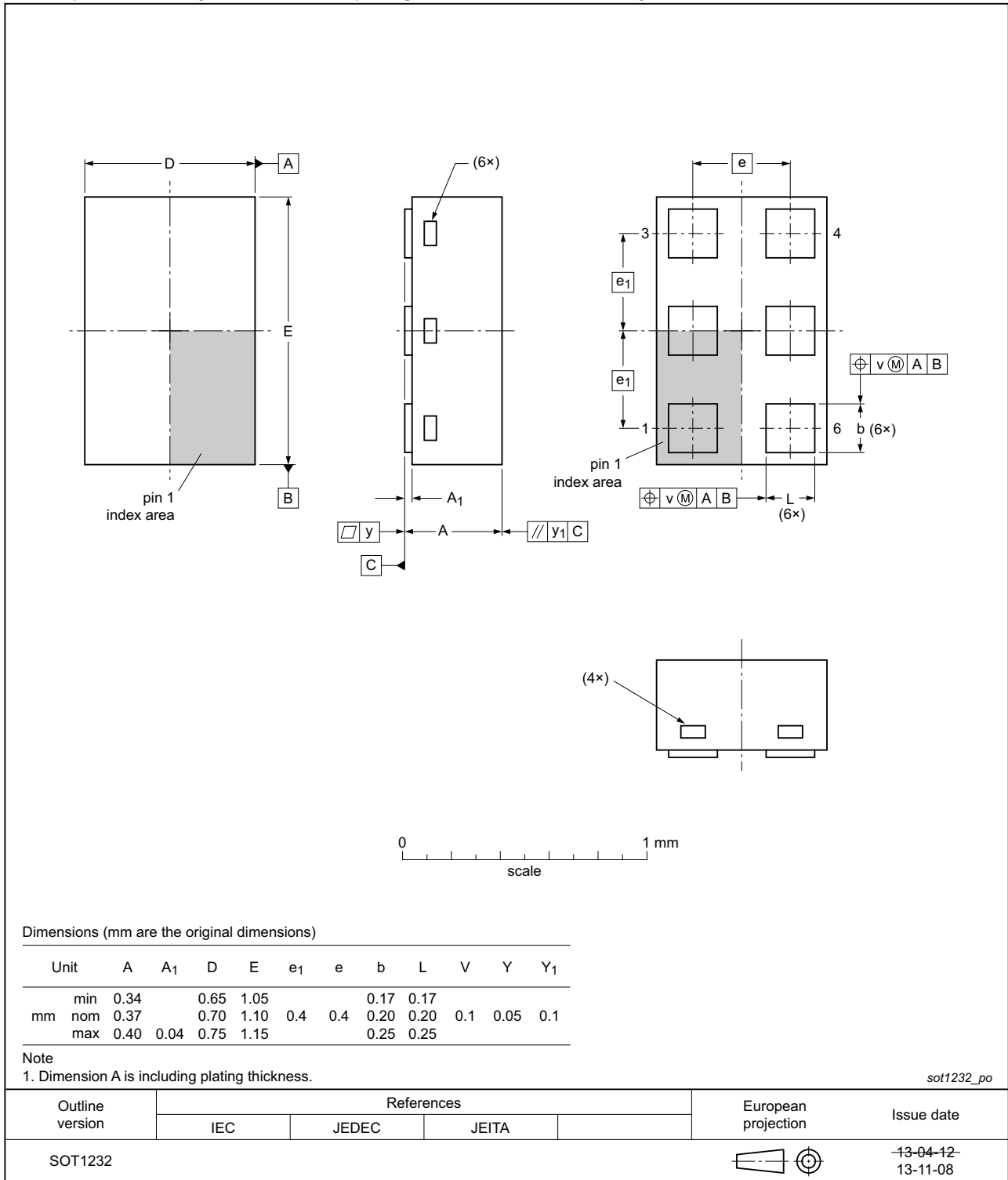

Fig 31. Package outline SOT1232 (XSON6)

11. Handling information

CAUTION



This device is sensitive to ElectroStatic Discharge (ESD). Observe precautions for handling electrostatic sensitive devices.

Such precautions are described in the *ANSI/ESD S20.20*, *IEC/ST 61340-5*, *JESD625-A* or equivalent standards.

12. Abbreviations

Table 11. Abbreviations

Acronym	Description
ESD	ElectroStatic Discharge
GLONASS	GLObal NAVigation Satellite System
GNSS	Global Navigation Satellite System
GPS	Global Positioning System
HBM	Human Body Model
MMIC	Monolithic Microwave Integrated Circuit
PCB	Printed Circuit Board
SiGe:C	Silicon Germanium Carbon

13. Revision history

Table 12. Revision history

Document ID	Release date	Data sheet status	Change notice	Supersedes
BGU8019 v.3	20170118	Product data sheet	-	BGU8019 v.2
Modifications:	<ul style="list-style-type: none"> Section 1: added GPS1202M according to our new naming convention 			
BGU8019 v.2	20140603	Product data sheet	-	BGU8019 v.1
BGU8019 v.1	20131112	Preliminary data sheet	-	-

14. Legal information

14.1 Data sheet status

Document status ^{[1][2]}	Product status ^[3]	Definition
Objective [short] data sheet	Development	This document contains data from the objective specification for product development.
Preliminary [short] data sheet	Qualification	This document contains data from the preliminary specification.
Product [short] data sheet	Production	This document contains the product specification.

[1] Please consult the most recently issued document before initiating or completing a design.

[2] The term 'short data sheet' is explained in section "Definitions".

[3] The product status of device(s) described in this document may have changed since this document was published and may differ in case of multiple devices. The latest product status information is available on the Internet at URL <http://www.nxp.com>.

14.2 Definitions

Draft — The document is a draft version only. The content is still under internal review and subject to formal approval, which may result in modifications or additions. NXP Semiconductors does not give any representations or warranties as to the accuracy or completeness of information included herein and shall have no liability for the consequences of use of such information.

Short data sheet — A short data sheet is an extract from a full data sheet with the same product type number(s) and title. A short data sheet is intended for quick reference only and should not be relied upon to contain detailed and full information. For detailed and full information see the relevant full data sheet, which is available on request via the local NXP Semiconductors sales office. In case of any inconsistency or conflict with the short data sheet, the full data sheet shall prevail.

Product specification — The information and data provided in a Product data sheet shall define the specification of the product as agreed between NXP Semiconductors and its customer, unless NXP Semiconductors and customer have explicitly agreed otherwise in writing. In no event however, shall an agreement be valid in which the NXP Semiconductors product is deemed to offer functions and qualities beyond those described in the Product data sheet.

14.3 Disclaimers

Limited warranty and liability — Information in this document is believed to be accurate and reliable. However, NXP Semiconductors does not give any representations or warranties, expressed or implied, as to the accuracy or completeness of such information and shall have no liability for the consequences of use of such information. NXP Semiconductors takes no responsibility for the content in this document if provided by an information source outside of NXP Semiconductors.

In no event shall NXP Semiconductors be liable for any indirect, incidental, punitive, special or consequential damages (including - without limitation - lost profits, lost savings, business interruption, costs related to the removal or replacement of any products or rework charges) whether or not such damages are based on tort (including negligence), warranty, breach of contract or any other legal theory.

Notwithstanding any damages that customer might incur for any reason whatsoever, NXP Semiconductors' aggregate and cumulative liability towards customer for the products described herein shall be limited in accordance with the *Terms and conditions of commercial sale* of NXP Semiconductors.

Right to make changes — NXP Semiconductors reserves the right to make changes to information published in this document, including without limitation specifications and product descriptions, at any time and without notice. This document supersedes and replaces all information supplied prior to the publication hereof.

Suitability for use — NXP Semiconductors products are not designed, authorized or warranted to be suitable for use in life support, life-critical or safety-critical systems or equipment, nor in applications where failure or malfunction of an NXP Semiconductors product can reasonably be expected to result in personal injury, death or severe property or environmental damage. NXP Semiconductors and its suppliers accept no liability for inclusion and/or use of NXP Semiconductors products in such equipment or applications and therefore such inclusion and/or use is at the customer's own risk.

Applications — Applications that are described herein for any of these products are for illustrative purposes only. NXP Semiconductors makes no representation or warranty that such applications will be suitable for the specified use without further testing or modification.

Customers are responsible for the design and operation of their applications and products using NXP Semiconductors products, and NXP Semiconductors accepts no liability for any assistance with applications or customer product design. It is customer's sole responsibility to determine whether the NXP Semiconductors product is suitable and fit for the customer's applications and products planned, as well as for the planned application and use of customer's third party customer(s). Customers should provide appropriate design and operating safeguards to minimize the risks associated with their applications and products.

NXP Semiconductors does not accept any liability related to any default, damage, costs or problem which is based on any weakness or default in the customer's applications or products, or the application or use by customer's third party customer(s). Customer is responsible for doing all necessary testing for the customer's applications and products using NXP Semiconductors products in order to avoid a default of the applications and the products or of the application or use by customer's third party customer(s). NXP does not accept any liability in this respect.

Limiting values — Stress above one or more limiting values (as defined in the Absolute Maximum Ratings System of IEC 60134) will cause permanent damage to the device. Limiting values are stress ratings only and (proper) operation of the device at these or any other conditions above those given in the Recommended operating conditions section (if present) or the Characteristics sections of this document is not warranted. Constant or repeated exposure to limiting values will permanently and irreversibly affect the quality and reliability of the device.

Terms and conditions of commercial sale — NXP Semiconductors products are sold subject to the general terms and conditions of commercial sale, as published at <http://www.nxp.com/profile/terms>, unless otherwise agreed in a valid written individual agreement. In case an individual agreement is concluded only the terms and conditions of the respective agreement shall apply. NXP Semiconductors hereby expressly objects to applying the customer's general terms and conditions with regard to the purchase of NXP Semiconductors products by customer.

No offer to sell or license — Nothing in this document may be interpreted or construed as an offer to sell products that is open for acceptance or the grant, conveyance or implication of any license under any copyrights, patents or other industrial or intellectual property rights.

Export control — This document as well as the item(s) described herein may be subject to export control regulations. Export might require a prior authorization from competent authorities.

Non-automotive qualified products — Unless this data sheet expressly states that this specific NXP Semiconductors product is automotive qualified, the product is not suitable for automotive use. It is neither qualified nor tested in accordance with automotive testing or application requirements. NXP Semiconductors accepts no liability for inclusion and/or use of non-automotive qualified products in automotive equipment or applications.

In the event that customer uses the product for design-in and use in automotive applications to automotive specifications and standards, customer (a) shall use the product without NXP Semiconductors' warranty of the product for such automotive applications, use and specifications, and (b) whenever customer uses the product for automotive applications beyond NXP Semiconductors' specifications such use shall be solely at customer's own risk, and (c) customer fully indemnifies NXP Semiconductors for any

liability, damages or failed product claims resulting from customer design and use of the product for automotive applications beyond NXP Semiconductors' standard warranty and NXP Semiconductors' product specifications.

Quick reference data — The Quick reference data is an extract of the product data given in the Limiting values and Characteristics sections of this document, and as such is not complete, exhaustive or legally binding.

Translations — A non-English (translated) version of a document is for reference only. The English version shall prevail in case of any discrepancy between the translated and English versions.

14.4 Trademarks

Notice: All referenced brands, product names, service names and trademarks are the property of their respective owners.

15. Contact information

For more information, please visit: <http://www.nxp.com>

For sales office addresses, please send an email to: salesaddresses@nxp.com

16. Contents

1	Product profile	1
1.1	General description	1
1.2	Features and benefits	1
1.3	Applications	2
1.4	Quick reference data	2
2	Pinning information	2
3	Ordering information	2
4	Marking	3
5	Limiting values	3
6	Recommended operating conditions	3
7	Thermal characteristics	3
8	Characteristics	4
9	Application information	6
9.1	GNSS LNA	6
9.2	Graphs	6
10	Package outline	14
11	Handling information	15
12	Abbreviations	15
13	Revision history	15
14	Legal information	16
14.1	Data sheet status	16
14.2	Definitions	16
14.3	Disclaimers	16
14.4	Trademarks	17
15	Contact information	17
16	Contents	18

Please be aware that important notices concerning this document and the product(s) described herein, have been included in section 'Legal information'.

© NXP Semiconductors N.V. 2017.

All rights reserved.

For more information, please visit: <http://www.nxp.com>

For sales office addresses, please send an email to: salesaddresses@nxp.com

Date of release: 18 January 2017

Document identifier: BGU8019