

High Speed Switching Diode

BAS516

FEATURES

- Ultra small plastic SMD package.
- High switching speed: max.4ns.
- Continuous reverse voltage: max.75V.
- Repetitive peak reverse voltage: max.85V
- Repetitive peak forward current: max.500mA



Lead-free

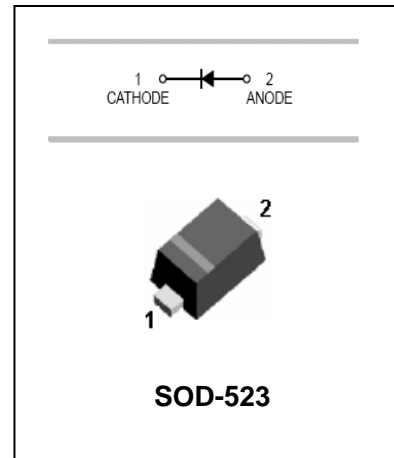

APPLICATIONS

- High-speed switching in surface mounted circuits.

ORDERING INFORMATION

Type No.	Marking	Package Code
BAS516	61	SOD-523

MAXIMUM RATING @ Ta=25°C unless otherwise specified

Parameter	Symbol	Limits	Unit
Repetitive peak reverse voltage	V_{RRM}	85	V
Continuous reverse voltage	V_R	75	V
Continuous forward current	I_F	250	mA
Repetitive forward current	I_{FRM}	500	mA
Non-repetitive peak forward surge current t=1μs t=1ms t=1s	I_{FSM}	4 1 0.5	A
Total power dissipation	P_{tot}	200	mW
Thermal resistance from junction to soldering point	R th j-s	120	K/W
Junction temperature	T_j	150	°C
Storage temperature	T_{stg}	-65 to +150	°C



High Speed Switching Diode

BAS516

ELECTRICAL CHARACTERISTICS @ Ta=25°C unless otherwise specified

Parameter	Symbol	Min.	Max.	Unit	Conditions
Forward voltage	V_F		0.715	V	$I_F=1\text{mA}$
			0.855	V	$I_F=10\text{mA}$
			1	V	$I_F=50\text{mA}$
			1.25	V	$I_F=150\text{mA}$
Reverse current	I_R		30	nA	$V_R=25\text{V}$
			30	μA	$V_R=25\text{V } T_J=150^\circ\text{C}$
			1	μA	$V_R=75\text{V}$
			50	μA	$V_R=75\text{V } T_J=150^\circ\text{C}$
Diode capacitance	C_d		1	pF	$V_R=0, f=1\text{MHz}$
Reverse recovery time	t_{rr}		4	ns	$I_F=10\text{mA}, I_R=10\text{mA}, R_L=400\Omega$

TYPICAL CHARACTERISTICS @ Ta=25°C unless otherwise specified

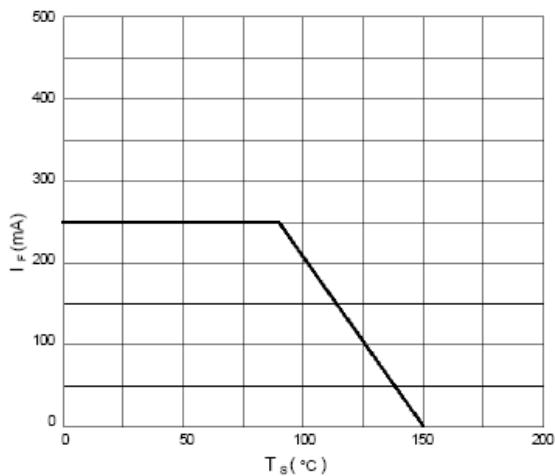

Fig.1 Maximum permissible continuous forward current as a function of soldering point temperature.

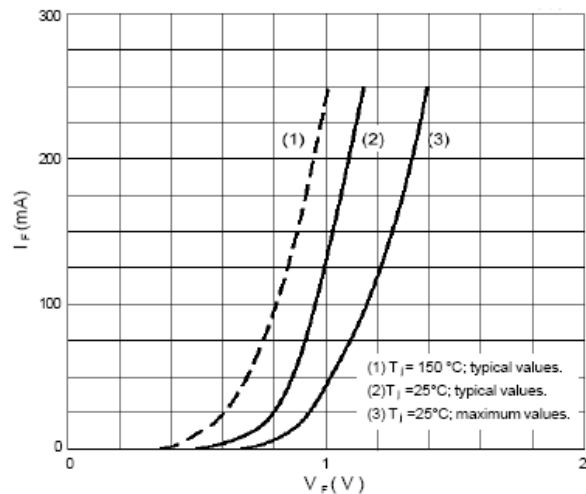

Fig.2 Forward current as a function of forward voltage.

High Speed Switching Diode

BAS516

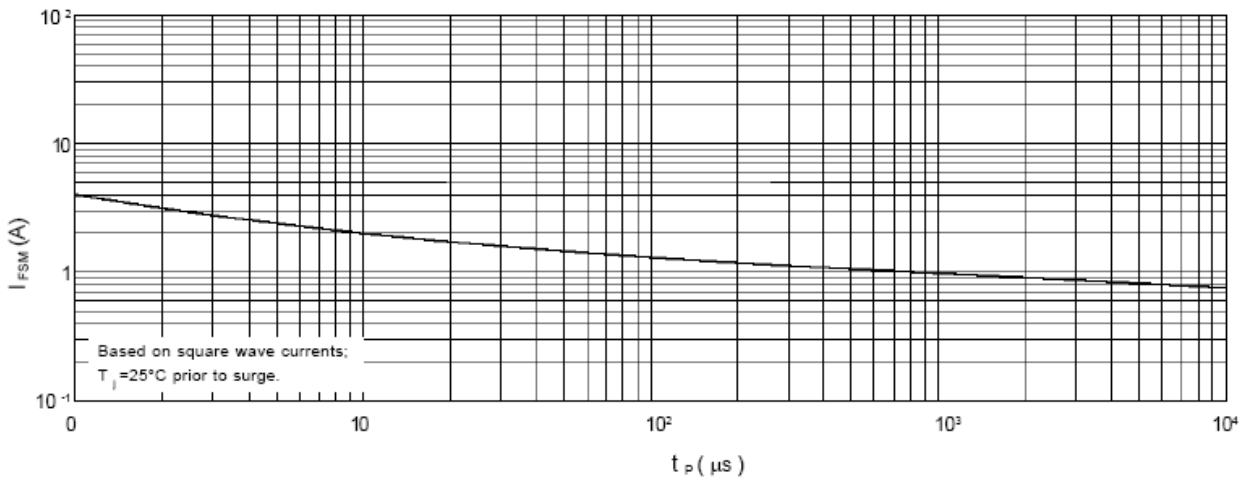

Fig.3 Maximum permissible non-repetitive peak forward current as a function of pulse duration.

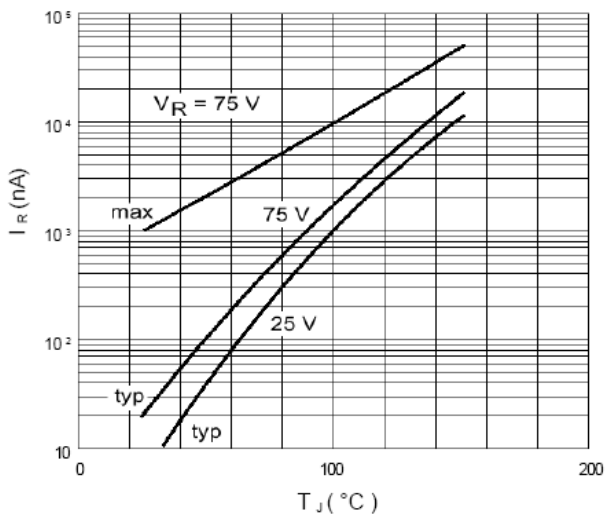

Fig.4 Reverse current as a function of junction temperature.

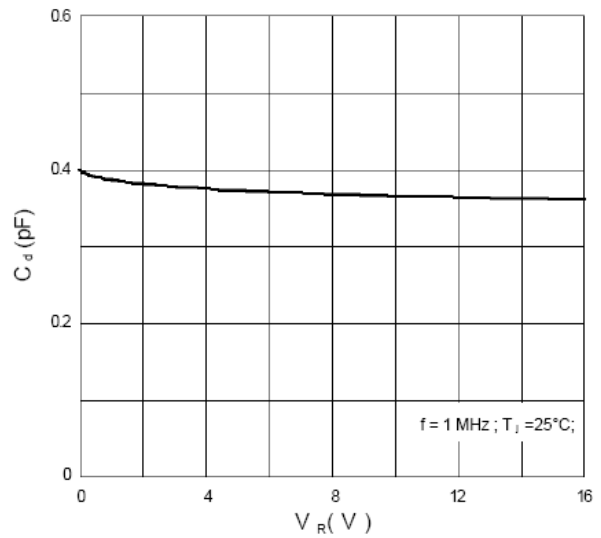

Fig.5 Diode capacitance as a function of reverse voltage; typical values.



High Speed Switching Diode

BAS516

PACKAGE OUTLINE

Plastic surface mounted package

SOD-523

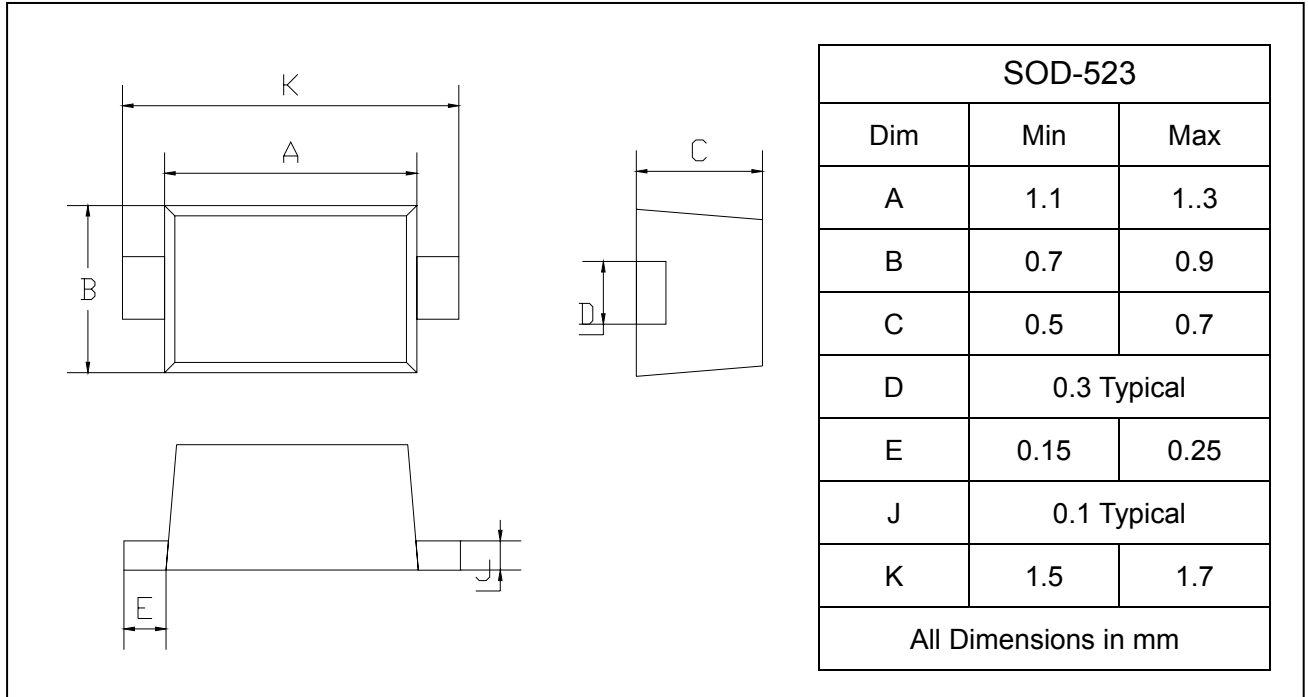

SOLDERING FOOTPRINT

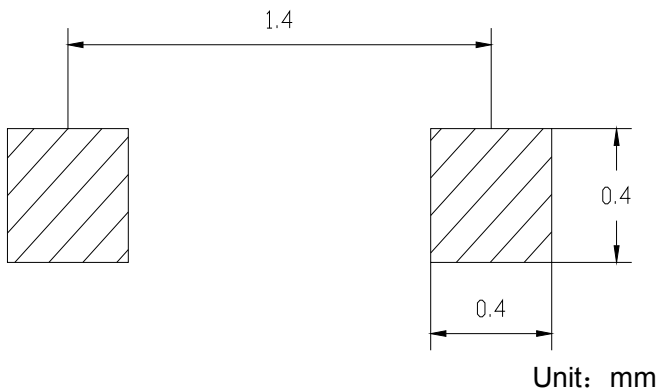

PACKAGE INFORMATION

Device	Package	Shipping
BAS516	SOD-523	3000/Tape&Reel