

**Silicon PIN Diode**

- Series diode for mobile communication in low loss transmit-receiver switches
- Band switch for TV-tuners
- Very low forward resistance (typ.  $0.65 \Omega @ 5 \text{ mA}$ )
- Low capacitance (typ.  $0.5 \text{ pF} @ 0\text{V}$ )
- Fast switching applications
- Pb-free (RoHS compliant) package

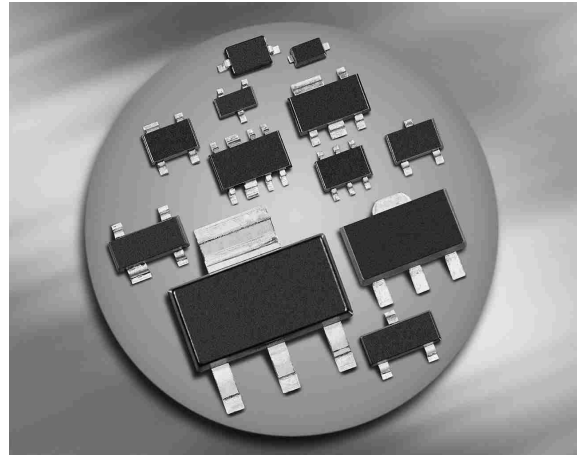

**BAR65-02L**  
**BAR65-02V**  
**BAR65-03W**

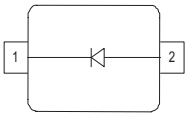

Type	Package	Configuration	$L_S$ (nH)	Marking
BAR65-02L*	TSLP-2-1	single, leadless	0.4	NN
BAR65-02V	SC79	single	0.6	N
BAR65-03W	SOD323	single	1.8	blue M

\* Preliminary Data

**Maximum Ratings** at  $T_A = 25^\circ\text{C}$ , unless otherwise specified

Parameter	Symbol	Value	Unit
Diode reverse voltage	$V_R$	30	V
Forward current	$I_F$	100	mA
Total power dissipation	$P_{\text{tot}}$		mW
BAR65-02L, $T_S \leq 128^\circ\text{C}$		250	
BAR65-02V, $T_S \leq 118^\circ\text{C}$		250	
BAR65-03W, $T_S \leq 113^\circ\text{C}$		250	
Junction temperature	$T_j$	150	$^\circ\text{C}$
Operating temperature range	$T_{\text{op}}$	-55 ... 125	
Storage temperature	$T_{\text{stg}}$	-55 ... 150	

**Thermal Resistance**

Parameter	Symbol	Value	Unit
Junction - soldering point <sup>1)</sup>	$R_{thJS}$		K/W
BAR65-02L		≤ 90	
BAR65-02V		≤ 130	
BAR65-03W		≤ 145	

**Electrical Characteristics at  $T_A = 25^\circ\text{C}$ , unless otherwise specified**

Parameter	Symbol	Values			Unit
		min.	typ.	max.	

**DC Characteristics**

Reverse current $V_R = 20\text{ V}$	$I_R$	-	-	20	nA
Forward voltage $I_F = 100\text{ mA}$	$V_F$	-	0.93	1	V

<sup>1)</sup>For calculation of  $R_{thJA}$  please refer to Application Note Thermal Resistance

**Electrical Characteristics at  $T_A = 25^\circ\text{C}$ , unless otherwise specified**

Parameter	Symbol	Values			Unit
		min.	typ.	max.	
<b>AC Characteristics</b>					
Diode capacitance $V_R = 1\text{ V}, f = 1\text{ MHz}$ $V_R = 3\text{ V}, f = 1\text{ MHz}$ $V_R = 0\text{ V}, f = 100\text{ MHz} \dots 1.8\text{ GHz}$	$C_T$	-	0.45 0.4 0.5	0.9 0.8 -	pF
Reverse parallel resistance $V_R = 0\text{ V}, f = 100\text{ MHz}$ $V_R = 0\text{ V}, f = 1\text{ GHz}$ $V_R = 0\text{ V}, f = 1.8\text{ GHz}$	$R_P$	-	700 10 5	- - -	k $\Omega$
Forward resistance $I_F = 1\text{ mA}, f = 100\text{ MHz}$ $I_F = 5\text{ mA}, f = 100\text{ MHz}$ $I_F = 10\text{ mA}, f = 100\text{ MHz}$	$r_f$	-	1 0.65 0.56	- 0.95 0.9	$\Omega$
Charge carrier life time $I_F = 10\text{ mA}, I_R = 6\text{ mA}$ , measured at $I_R = 3\text{ mA}$ , $R_L = 100\ \Omega$	$\tau_{rr}$	-	80	-	ns
I-region width	$W_I$	-	3.5	-	$\mu\text{m}$
Insertion loss <sup>1)</sup> $I_F = 1\text{ mA}, f = 1.8\text{ GHz}$ $I_F = 5\text{ mA}, f = 1.8\text{ GHz}$ $I_F = 10\text{ mA}, f = 1.8\text{ GHz}$	$I_L$	-	0.08 0.06 0.05	- - -	dB
Isolation <sup>1)</sup> $V_R = 0\text{ V}, f = 0.9\text{ GHz}$ $V_R = 0\text{ V}, f = 1.8\text{ GHz}$ $V_R = 0\text{ V}, f = 2.45\text{ GHz}$	$I_{SO}$	-	12 7 5	- - -	

<sup>1</sup>BAR65-02L in series configuration,  $Z = 50\ \Omega$

**Diode capacitance  $C_T = f(V_R)$**

$f = \text{Parameter}$

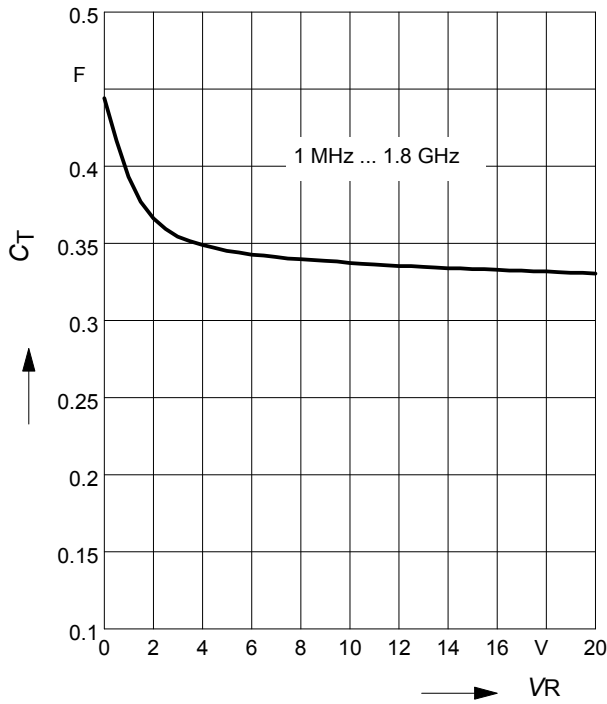

**Reverse parallel resistance  $R_P = f(V_R)$**

$f = \text{Parameter}$

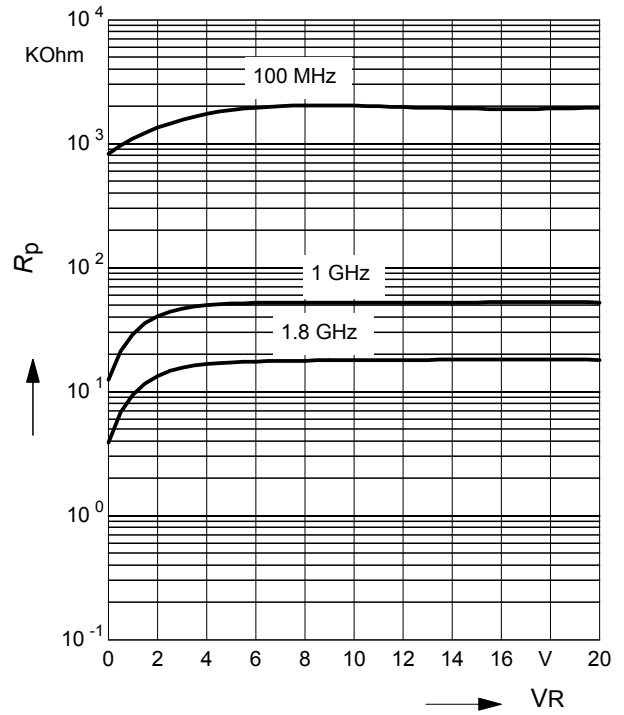

**Forward resistance  $r_f = f(I_F)$**

$f = 100\text{MHz}$

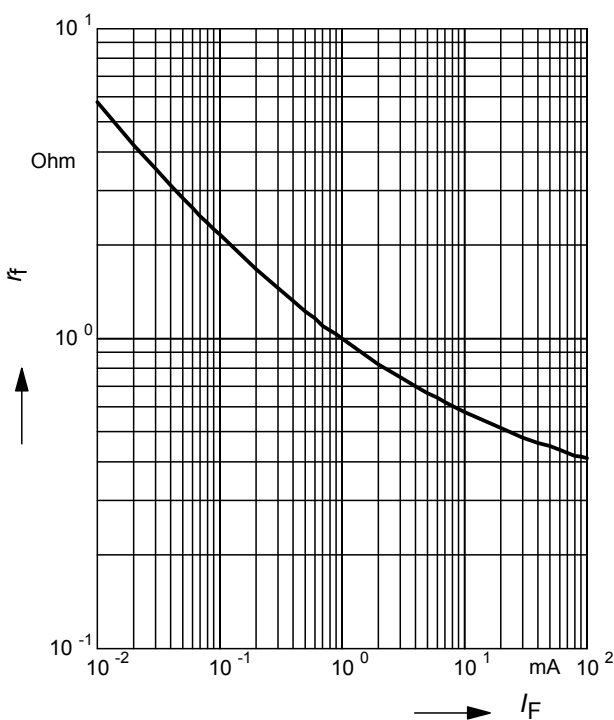

**Forward current  $I_F = f(V_F)$**

$T_A = \text{Parameter}$

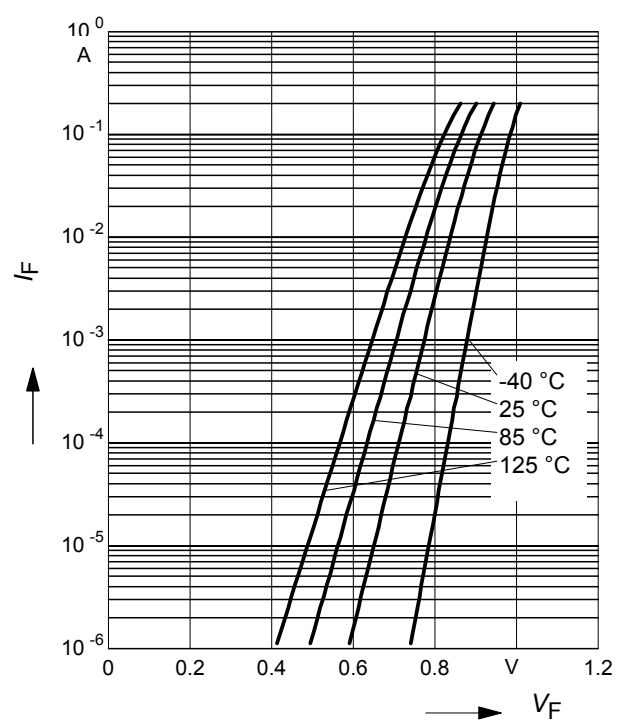

**Forward current  $I_F = f(T_S)$**

BAR65-02L

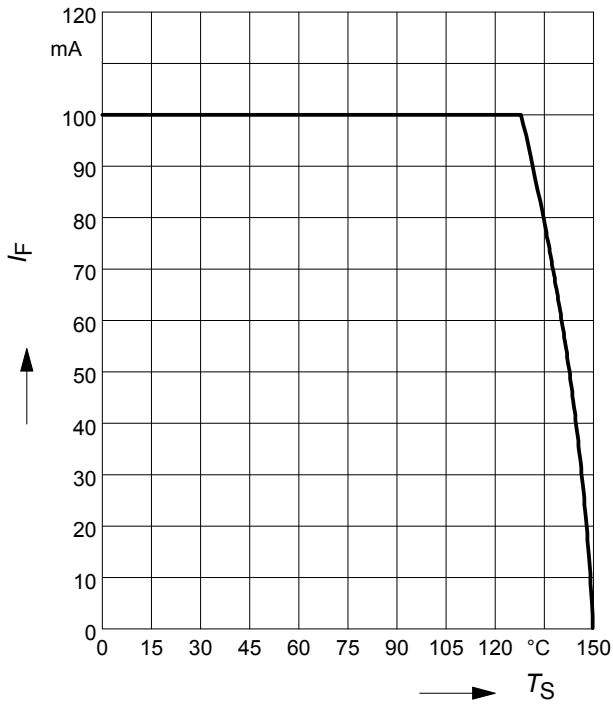

**Forward current  $I_F = f(T_S)$**

BAR65-02V

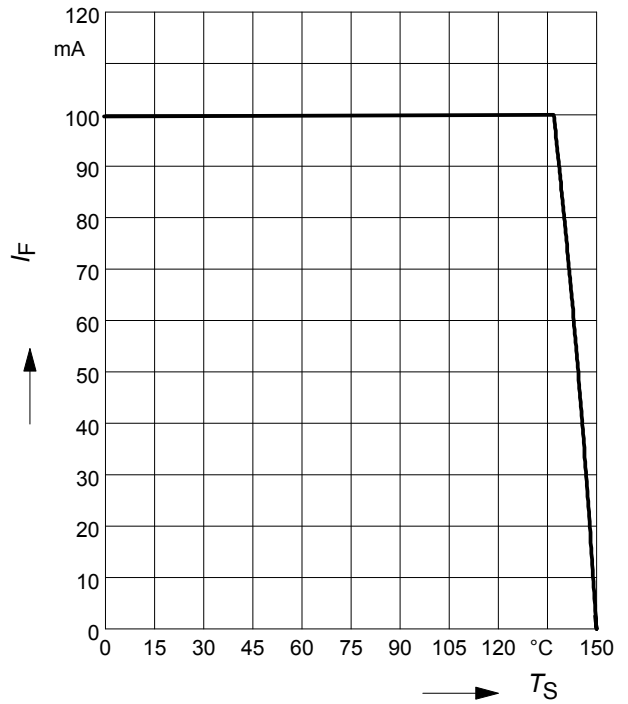

**Forward current  $I_F = f(T_S)$**

BAR65-03W

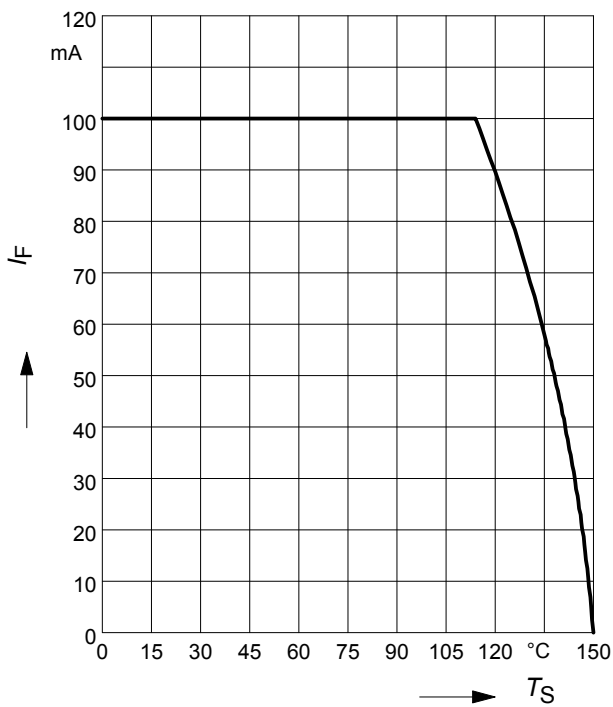

**Permissible Puls Load  $R_{thJS} = f(t_p)$**

BAR65-02L

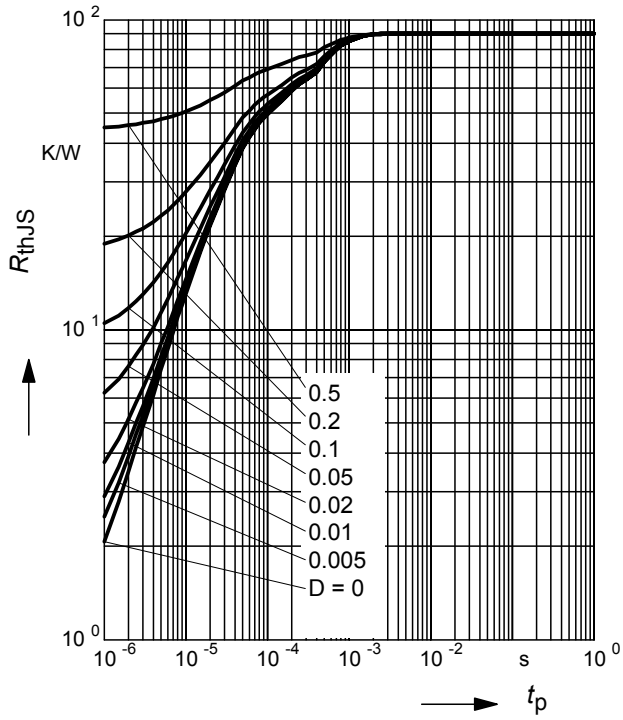

**Permissible Pulse Load  $I_{Fmax}/I_{FDC} = f(t_p)$**

$I_{Fmax}/I_{FDC} = f(t_p)$

BAR65-02L

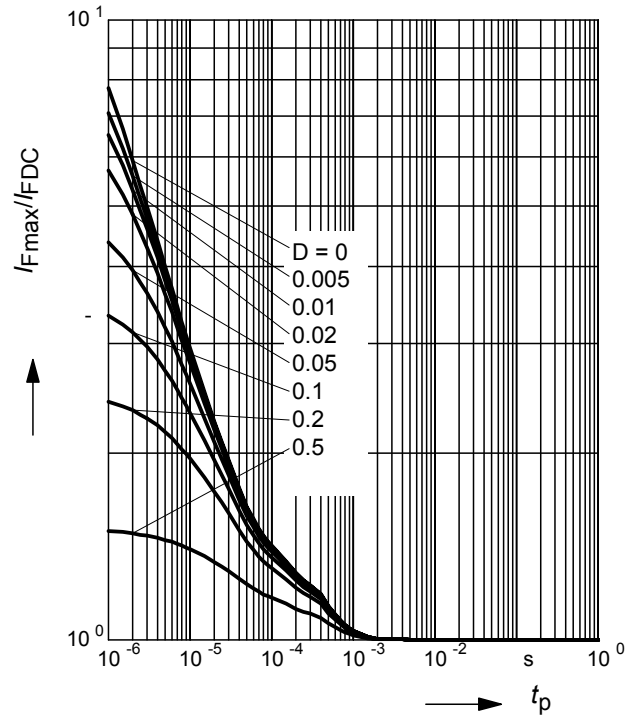

**Permissible Puls Load  $R_{thJS} = f(t_p)$**

BAR65-02V

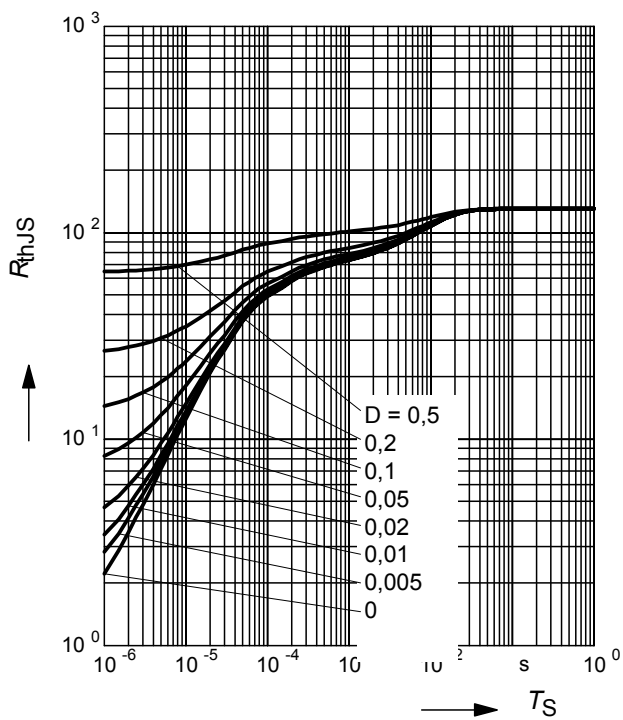

**Permissible Pulse Load  $I_{Fmax}/I_{FDC} = f(t_p)$**

$I_{Fmax}/I_{FDC} = f(t_p)$

BAR65-02V

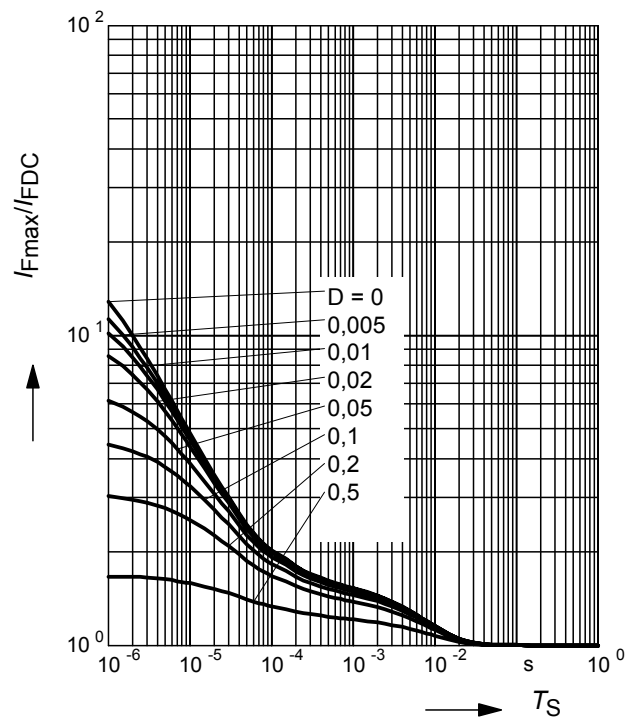

**Permissible Puls Load  $R_{thJS} = f(t_p)$**

BAR65-03W

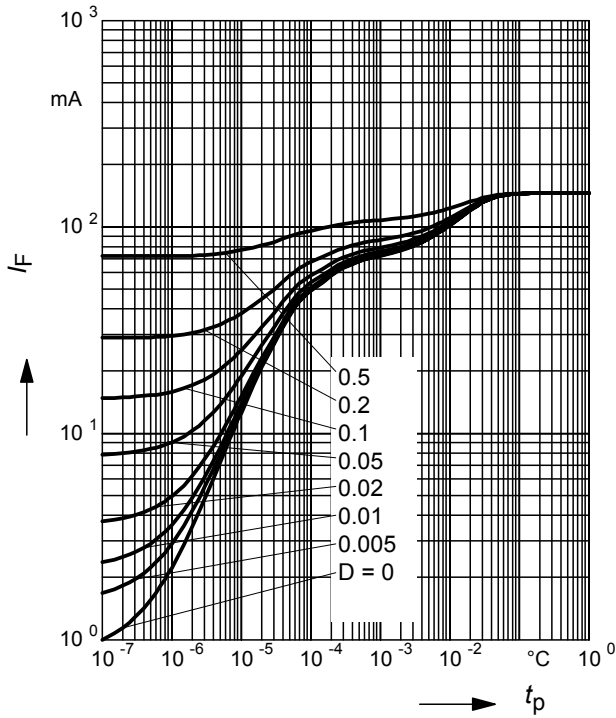

**Permissible Pulse Load**

$I_{Fmax} / I_{FDC} = f(t_p)$

BAR65-03W

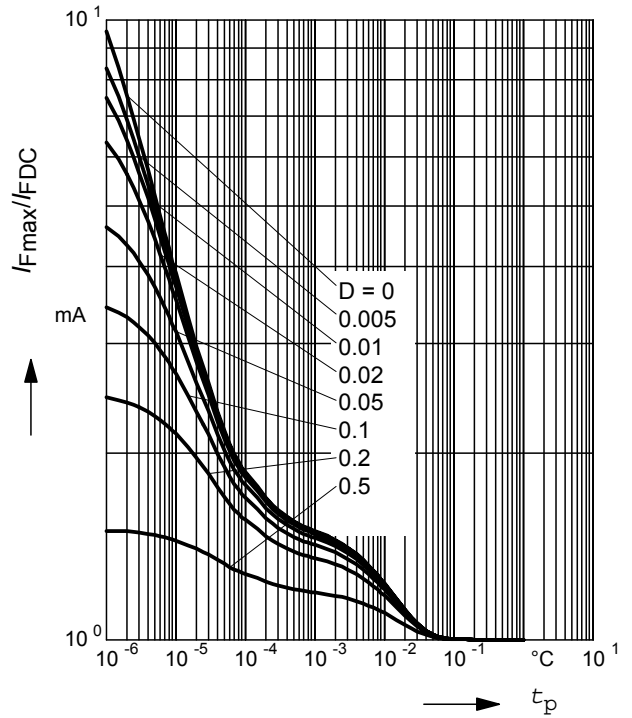

**Insertion loss  $I_L = -|S_{21}|^2 = f(f)$**

$I_F$  = Parameter

BAR65-02L in series configuration,  $Z = 50\Omega$

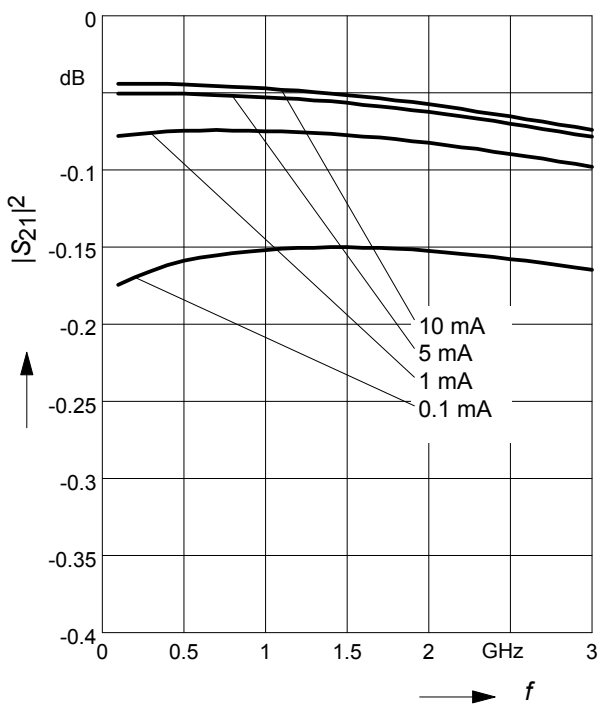

**Isolation  $I_{SO} = -|S_{21}|^2 = f(f)$**

$V_R$  = Parameter

BAR65-02L in series configuration  $Z = 50\Omega$

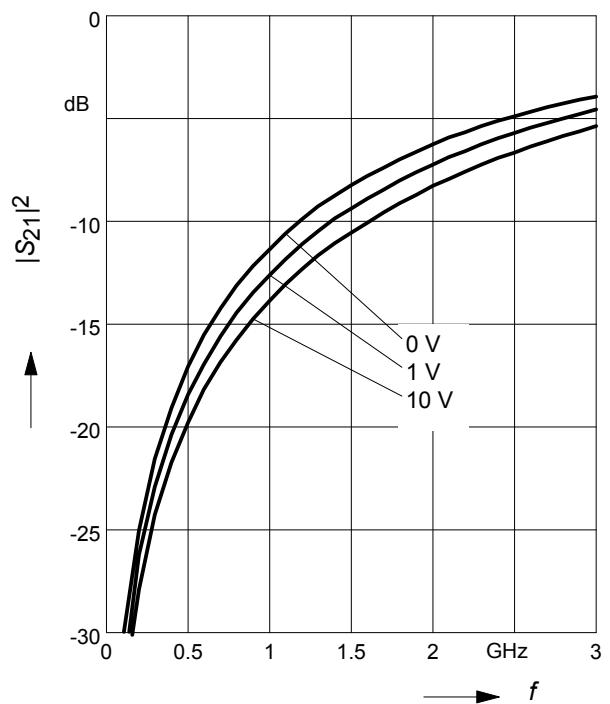

### Package Outline

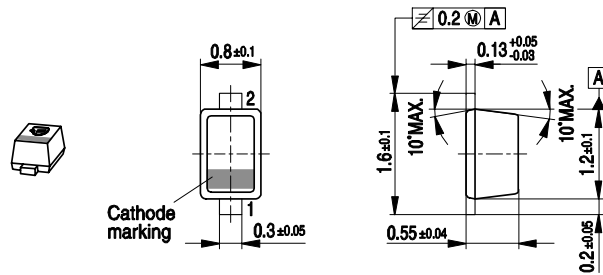

### Foot Print

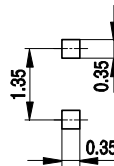

### Marking Layout (Example)

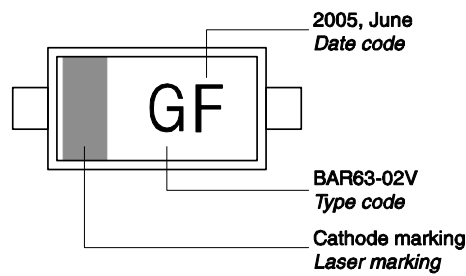

### Standard Packing

- Reel ø180 mm = 3.000 Pieces/Reel
- Reel ø180 mm = 8.000 Pieces/Reel (2 mm Pitch)
- Reel ø330 mm = 10.000 Pieces/Reel

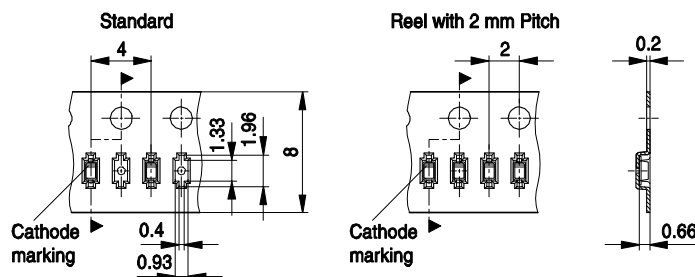



Date Code marking for discrete packages with one digit (SCD80, SC79, SC75<sup>1)</sup>) CES-Code

Month	2003	2004	2005	2006	2007	2008	2009	2010	2011	2012	2013	2014
01	a	p	A	P	a	p	A	P	a	p	A	P
02	b	q	B	Q	b	q	B	Q	b	q	B	Q
03	c	r	C	R	c	r	C	R	c	r	C	R
04	d	s	D	S	d	s	D	S	d	s	D	S
05	e	t	E	T	e	t	E	T	e	t	E	T
06	f	u	F	U	f	u	F	U	f	u	F	U
07	g	v	G	V	g	v	G	V	g	v	G	V
08	h	x	H	X	h	x	H	X	h	x	H	X
09	j	y	J	Y	j	y	J	Y	j	y	J	Y
10	k	z	K	Z	k	z	K	Z	k	z	K	Z
11	l	2	L	4	l	2	L	4	l	2	L	4
12	n	3	N	5	n	3	N	5	n	3	N	5

1) New Marking Layout for SC75, implemented at October 2005.

Package Outline

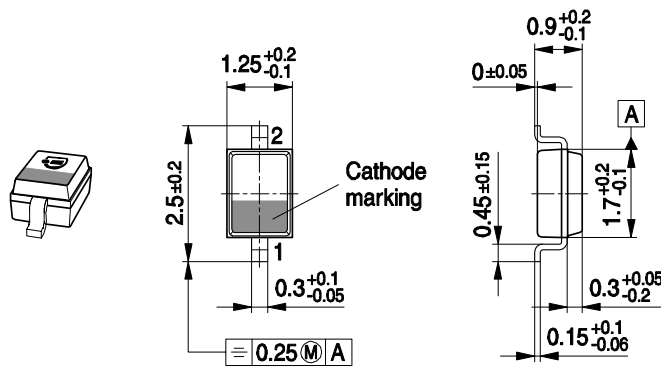

Foot Print

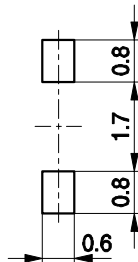

Marking Layout (Example)

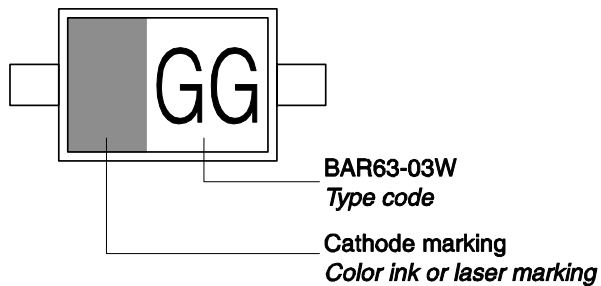

Standard Packing

Reel ø180 mm = 3.000 Pieces/Reel  
 Reel ø330 mm = 10.000 Pieces/Reel

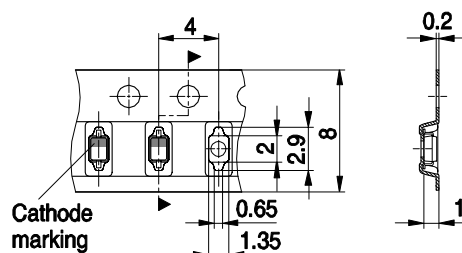

### Package Outline

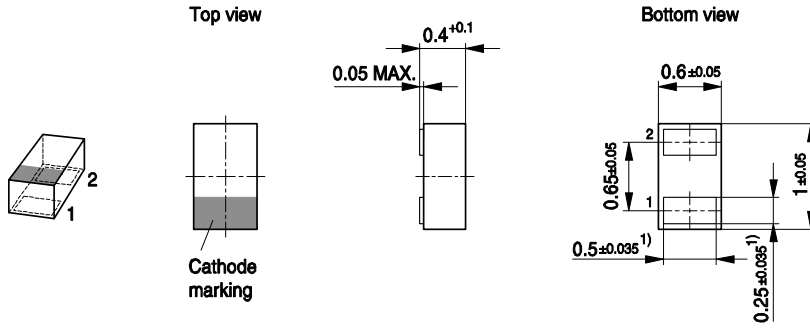

1) Dimension applies to plated terminal

### Foot Print

For board assembly information please refer to Infineon website "Packages"

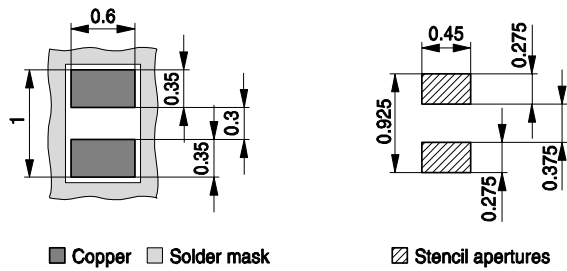

### Marking Layout (Example)

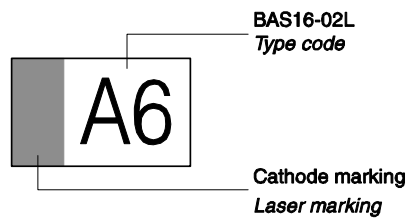

### Standard Packing

Reel  $\varnothing$ 180 mm = 15.000 Pieces/Reel  
 Reel  $\varnothing$ 330 mm = 50.000 Pieces/Reel (optional)

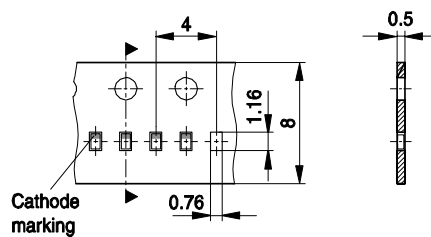

**Edition 2009-11-16**

**Published by  
Infineon Technologies AG  
81726 Munich, Germany**

**© 2009 Infineon Technologies AG  
All Rights Reserved.**

### **Legal Disclaimer**

The information given in this document shall in no event be regarded as a guarantee of conditions or characteristics. With respect to any examples or hints given herein, any typical values stated herein and/or any information regarding the application of the device, Infineon Technologies hereby disclaims any and all warranties and liabilities of any kind, including without limitation, warranties of non-infringement of intellectual property rights of any third party.

### **Information**

For further information on technology, delivery terms and conditions and prices, please contact the nearest Infineon Technologies Office ([<www.infineon.com>](http://www.infineon.com)).

### **Warnings**

Due to technical requirements, components may contain dangerous substances. For information on the types in question, please contact the nearest Infineon Technologies Office.

Infineon Technologies components may be used in life-support devices or systems only with the express written approval of Infineon Technologies, if a failure of such components can reasonably be expected to cause the failure of that life-support device or system or to affect the safety or effectiveness of that device or system. Life support devices or systems are intended to be implanted in the human body or to support and/or maintain and sustain and/or protect human life. If they fail, it is reasonable to assume that the health of the user or other persons may be endangered.