

- Advanced Process Technology
- Optimized for Automotive Motor Drive, DC-DC and other Heavy Load Applications
- Exceptionally Small Footprint and Low Profile
- High Power Density
- Low Parasitic Parameters
- Dual Sided Cooling
- 175°C Operating Temperature
- Repetitive Avalanche Allowed up to Tjmax
- Lead Free, RoHS Compliant and Halogen Free
- Automotive Qualified \*

$V_{(BR)DSS}$	<b>60V</b>
$R_{DS(on)}$ <b>typ.</b>	<b>1.1mΩ</b>
<b>max.</b>	<b>1.5mΩ</b>
$I_D$ (Silicon Limited)	<b>345A</b>
$Q_g$	<b>183nC</b>

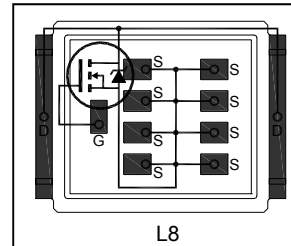

Applicable DirectFET™ Outline and Substrate Outline ①

SB	SC		M2	M4		L4	L6	<b>L8</b>	
----	----	--	----	----	--	----	----	-----------	--

**Description**

The AUIRF7749L2 combines the latest Automotive HEXFET® Power MOSFET Silicon technology with the advanced DirectFET™ packaging technology to achieve exceptional performance in a package that has the footprint of a D-Pak (TO-252AA) and only 0.7mm profile. The DirectFET™ package is compatible with existing layout geometries used in power applications, PCB assembly equipment and vapor phase, infra-red or convection soldering techniques, when application note AN-1035 is followed regarding the manufacturing methods and processes. The DirectFET™ package allows dual sided cooling to maximize thermal transfer in automotive power systems.

This HEXFET® Power MOSFET is designed for applications where efficiency and power density are of value. The advanced DirectFET™ packaging platform coupled with the latest silicon technology allows the AUIRF7749L2 to offer substantial system level savings and performance improvement specifically in motor drive, DC-DC and other heavy load applications on ICE, HEV and EV platforms. This MOSFET utilizes the latest processing techniques to achieve ultra low on-resistance per silicon area. Additional features of this MOSFET are 175°C operating junction temperature and high repetitive peak current capability. These features combine to make this MOSFET a highly efficient, robust and reliable device for high current automotive applications.

Base Part Number	Package Type	Standard Pack		Orderable Part Number
		Form	Quantity	
AUIRF7749L2	DirectFET™ Large Can	Tape and Reel	4000	AUIRF7749L2TR

**Absolute Maximum Ratings**

Stresses beyond those listed under "Absolute Maximum Ratings" may cause permanent damage to the device. These are stress ratings only; and functional operation of the device at these or any other condition beyond those indicated in the specifications is not implied. Exposure to absolute-maximum-rated conditions for extended periods may affect device reliability. The thermal resistance and power dissipation ratings are measured under board mounted and still air conditions. Ambient temperature (TA) is 25°C, unless otherwise specified.

	Parameter	Max.	Units
$V_{DS}$	Drain-to-Source Voltage	60	V
$I_D @ T_C = 25^\circ C$	Continuous Drain Current, $V_{GS} @ 10V$ ④	345	A
$I_D @ T_C = 100^\circ C$	Continuous Drain Current, $V_{GS} @ 10V$ ④	243	
$I_D @ T_A = 25^\circ C$	Continuous Drain Current, $V_{GS} @ 10V$ ③	36	
$I_D @ T_C = 25^\circ C$	Continuous Drain Current, $V_{GS} @ 10V$ (Package limit) ④	375	
$I_{DM}$	Pulsed Drain Current ⑤	1380	
$P_D @ T_C = 25^\circ C$	Power Dissipation ④	341	W
$P_D @ T_A = 25^\circ C$	Power Dissipation ③	3.8	
$E_{AS}$	Single Pulse Avalanche Energy (Thermally Limited) ⑥	315	mJ
$E_{AS} (Tested)$	Single Pulse Avalanche Energy ⑥	714	
$I_{AR}$	Avalanche Current ⑤	See Fig. 16, 17, 18a, 18b	A
$E_{AR}$	Repetitive Avalanche Energy ⑤		mJ
$T_P$	Peak Soldering Temperature	270	°C
$T_J$	Operating Junction and	-55 to + 175	
$T_{STG}$	Storage Temperature Range		

HEXFET® is a registered trademark of International Rectifier.

\*Qualification standards can be found at : [www.infineon.com](http://www.infineon.com)

**Thermal Resistance**

Symbol	Parameter	Typ.	Max.	Units
$R_{\theta JA}$	Junction-to-Ambient ③	—	40	°C/W
$R_{\theta JA}$	Junction-to-Ambient ⑧	12.5	—	
$R_{\theta JA}$	Junction-to-Ambient ⑨	20	—	
$R_{\theta J-Can}$	Junction-to-Can ④⑩	—	0.44	
$R_{\theta J-PCB}$	Junction-to-PCB Mounted	—	0.5	
	Linear Derating Factor ④	2.3		W/°C

**Static Electrical Characteristics @  $T_J = 25^\circ\text{C}$  (unless otherwise specified)**

Symbol	Parameter	Min.	Typ.	Max.	Units	Conditions
$V_{(BR)DSS}$	Drain-to-Source Breakdown Voltage	60	—	—	V	$V_{GS} = 0V, I_D = 250\mu A$
$\Delta V_{(BR)DSS}/\Delta T_J$	Breakdown Voltage Temp. Coefficient	—	56	—	mV/°C	Reference to $25^\circ\text{C}$ , $I_D = 3.0\text{mA}$
$R_{DS(on)}$	Static Drain-to-Source On-Resistance	—	1.1	1.5	m $\Omega$	$V_{GS} = 10V, I_D = 120A$
$V_{GS(th)}$	Gate Threshold Voltage	2.0	—	4.0	V	$V_{DS} = V_{GS}, I_D = 250\mu A$
$\Delta V_{GS(th)}/\Delta T_J$	Gate Threshold Voltage Coefficient	—	-8.8	—	mV/°C	
gfs	Forward Trans conductance	185	—	—	S	$V_{DS} = 10V, I_D = 120A$
$R_G$	Internal Gate Resistance	—	1.5	—	$\Omega$	
$I_{DSS}$	Drain-to-Source Leakage Current	—	—	20	$\mu A$	$V_{DS} = 60V, V_{GS} = 0V$
		—	—	250		$V_{DS} = 60V, V_{GS} = 0V, T_J = 125^\circ\text{C}$
$I_{GSS}$	Gate-to-Source Forward Leakage	—	—	100	nA	$V_{GS} = 20V$
	Gate-to-Source Reverse Leakage	—	—	-100		$V_{GS} = -20V$

**Dynamic Electrical Characteristics @  $T_J = 25^\circ\text{C}$  (unless otherwise specified)**

Symbol	Parameter	Min.	Typ.	Max.	Units	Conditions
$Q_g$	Total Gate Charge	—	183	275	nC	$V_{DS} = 30V$ $V_{GS} = 10V$ $I_D = 120A$
$Q_{gs1}$	Gate-to-Source Charge	—	39	—		
$Q_{gs2}$	Gate-to-Source Charge	—	19	—		
$Q_{gd}$	Gate-to-Drain ("Miller") Charge	—	46	—		
$Q_{godr}$	Gate Charge Overdrive	—	79	—		
$Q_{sw}$	Switch Charge ( $Q_{gs2} + Q_{gd}$ )	—	65	—		
$Q_{oss}$	Output Charge	—	119	—	nC	$V_{DS} = 48V, V_{GS} = 0V$
$t_{d(on)}$	Turn-On Delay Time	—	29	—	ns	$V_{DD} = 30V, V_{GS} = 10V$ ⑦ $I_D = 120A$ $R_G = 1.8\Omega$
$t_r$	Rise Time	—	149	—		
$t_{d(off)}$	Turn-Off Delay Time	—	72	—		
$t_f$	Fall Time	—	88	—		
$C_{iss}$	Input Capacitance	—	10655	—	pF	$V_{GS} = 0V$
$C_{oss}$	Output Capacitance	—	1627	—		$V_{DS} = 25V$
$C_{riss}$	Reverse Transfer Capacitance	—	680	—		$f = 1.0\text{MHz}$
$C_{oss\text{ eff.}}$	Effective Output Capacitance	—	1959	—		$V_{GS} = 0V, V_{DS} = 0V\text{ to }48V$

Notes ① through ⑩ are on page 11

**Diode Characteristics**

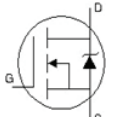
Symbol	Parameter	Min.	Typ.	Max.	Units	Conditions
$I_S$	Continuous Source Current (Body Diode)	—	—	345	A	MOSFET symbol showing the integral reverse p-n junction diode. 
$I_{SM}$	Pulsed Source Current (Body Diode) ⑤	—	—	1380		
$V_{SD}$	Diode Forward Voltage	—	—	1.3	V	$T_J = 25^\circ\text{C}$ , $I_S = 120\text{A}$ , $V_{GS} = 0\text{V}$ ⑦
$t_{rr}$	Reverse Recovery Time	—	42	—	ns	$I_F = 120\text{A}$ , $V_{DD} = 30\text{V}$
$Q_{rr}$	Reverse Recovery Charge	—	54	—	nC	$di/dt = 100\text{A}/\mu\text{s}$ ⑧

Notes ① through ⑩ are on page 11



③ Surface mounted on 1 in. square Cu board (still air).

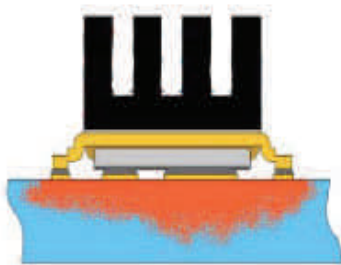

⑨ Mounted to a PCB with small clip heatsink (still air)

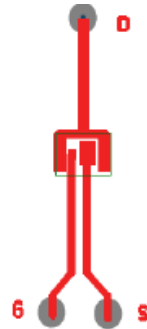

⑩ Mounted on minimum footprint full size board with metalized back and with small clip heatsink (still air).

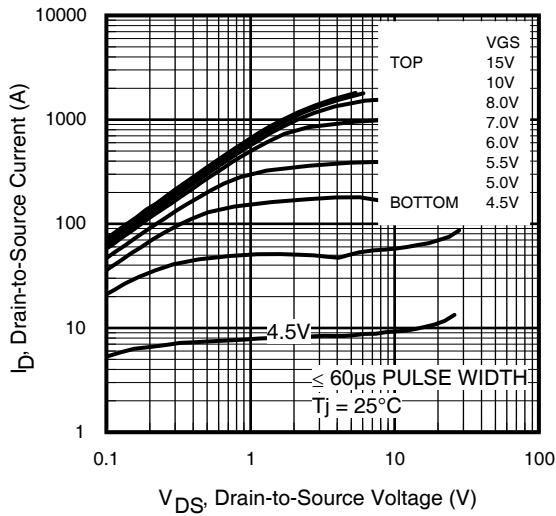
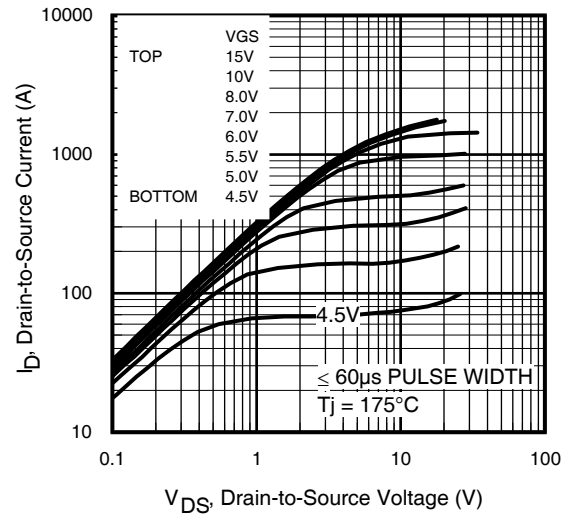
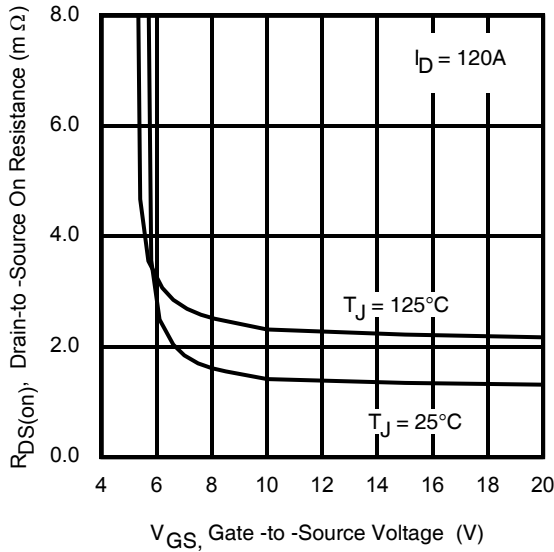
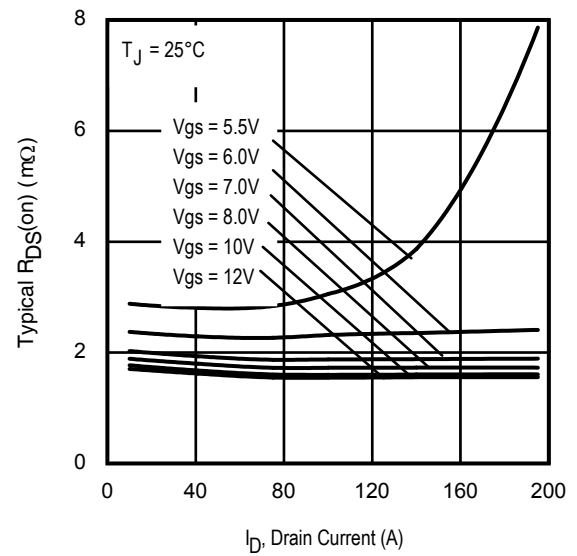
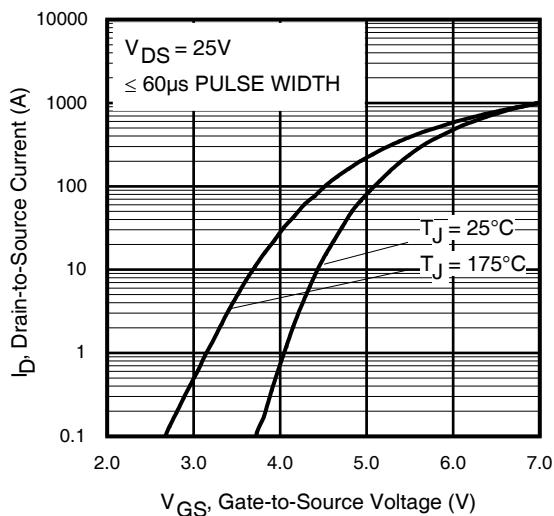
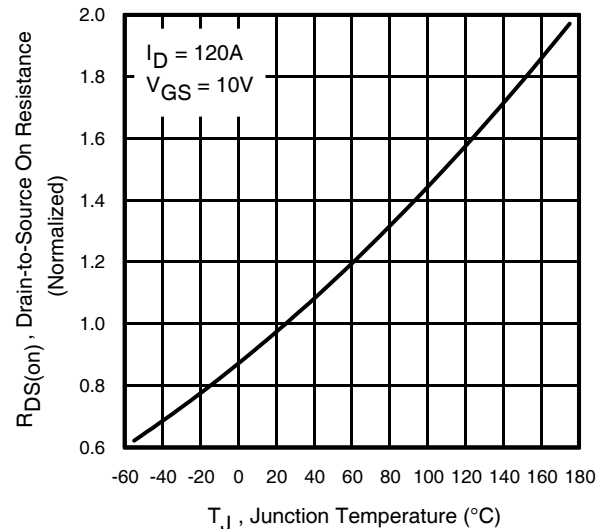
**Fig. 1** Typical Output Characteristics

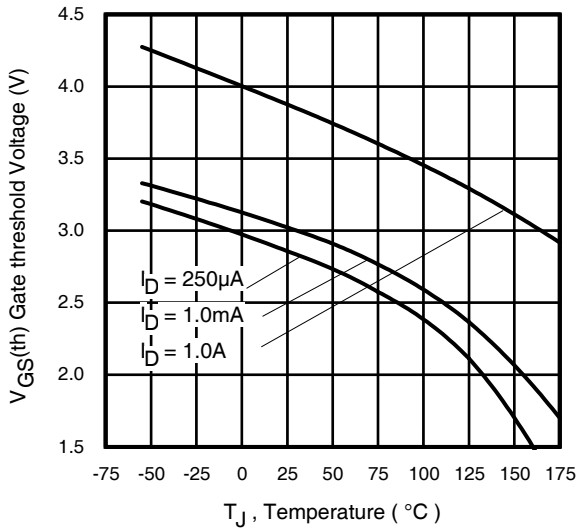
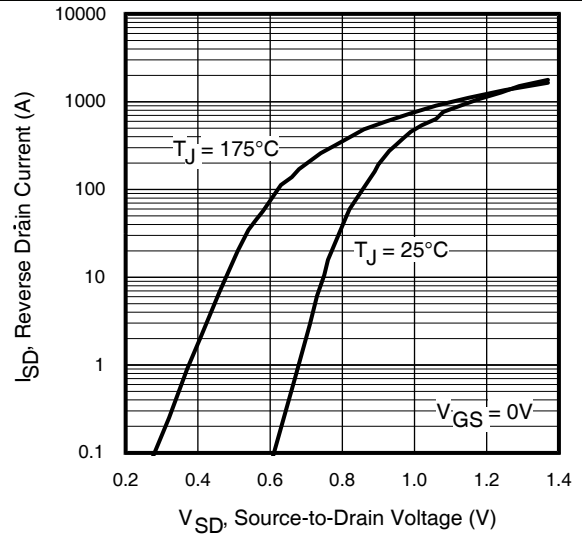
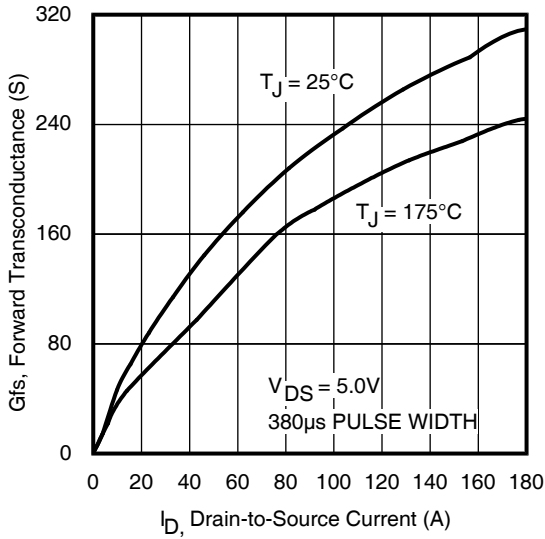
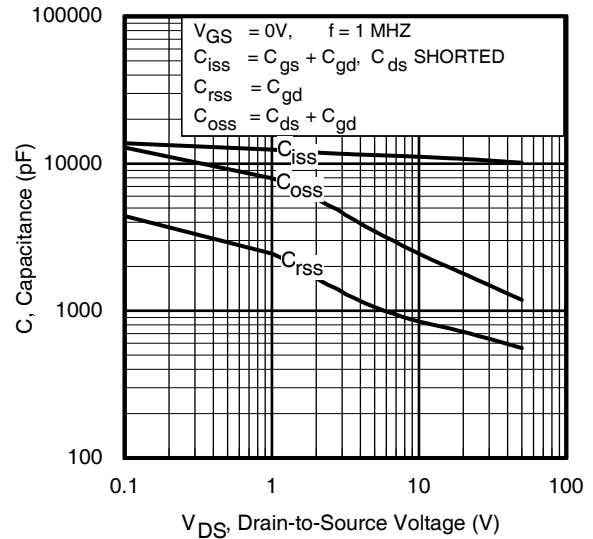
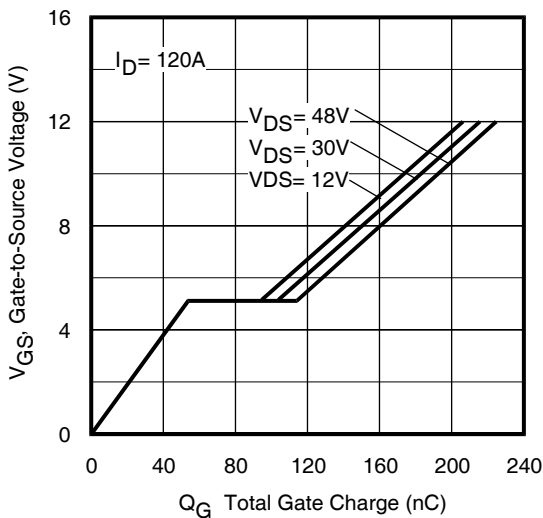
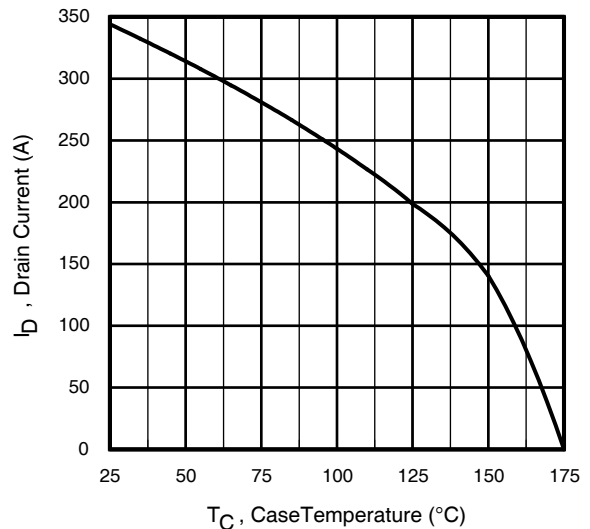
**Fig. 2** Typical Output Characteristics

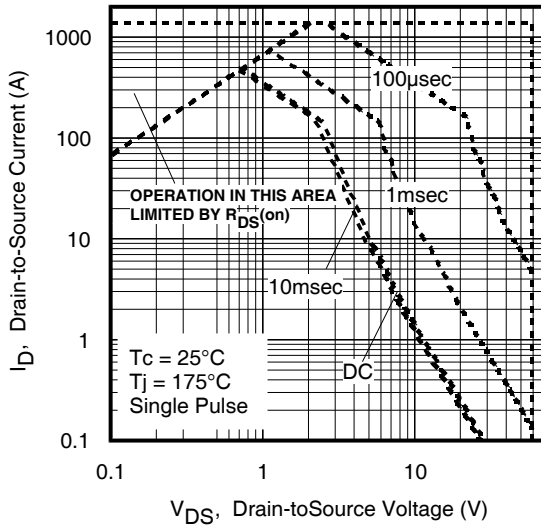
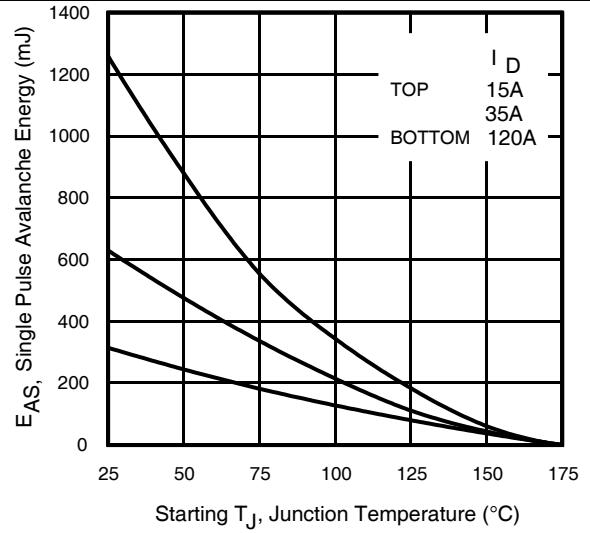
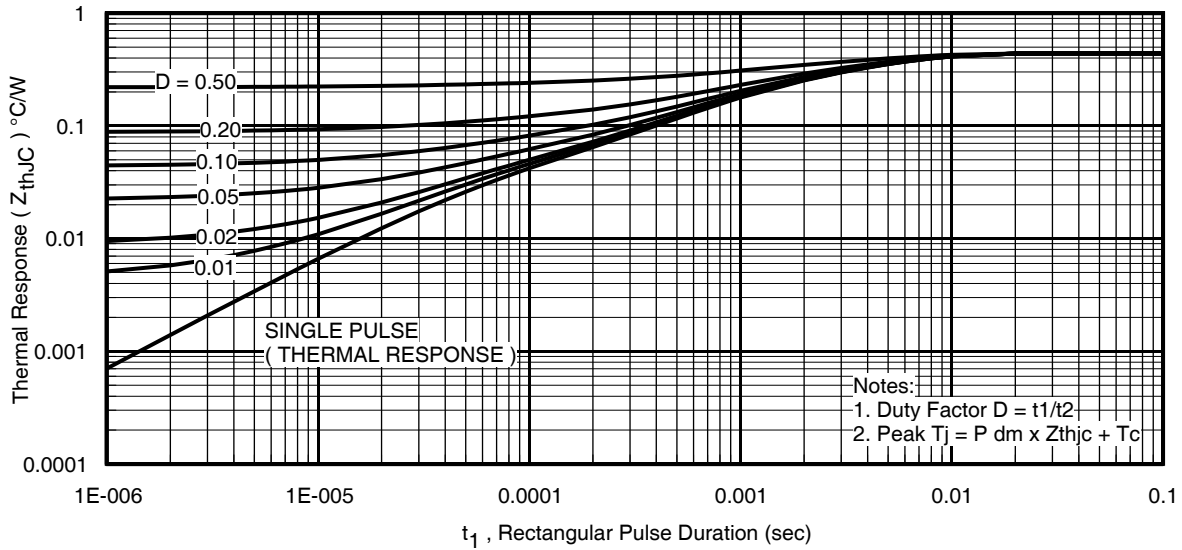
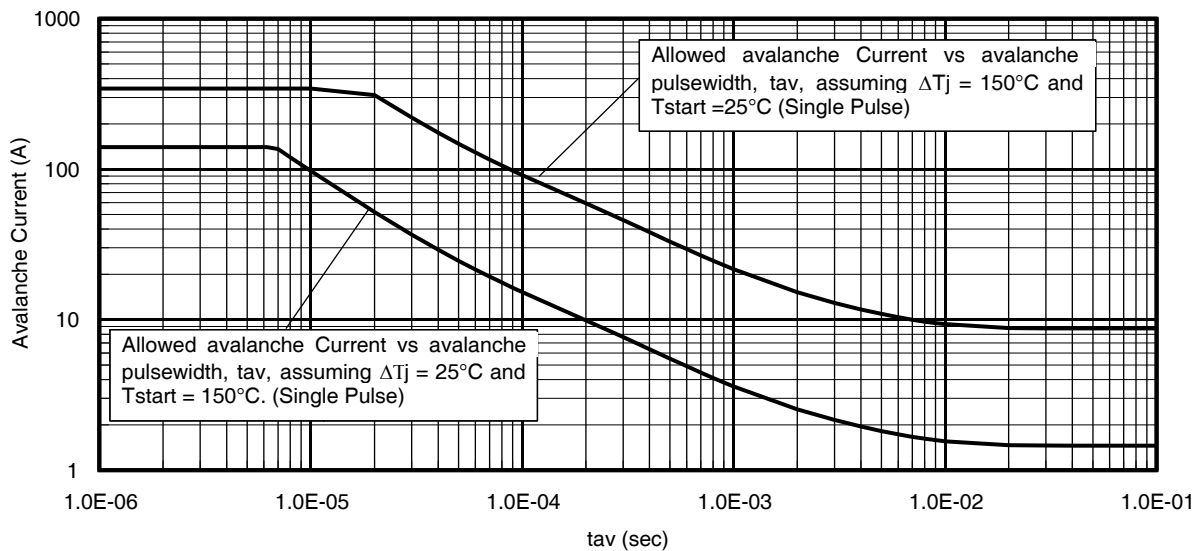
**Fig. 3** Typical On-Resistance vs. Gate Voltage

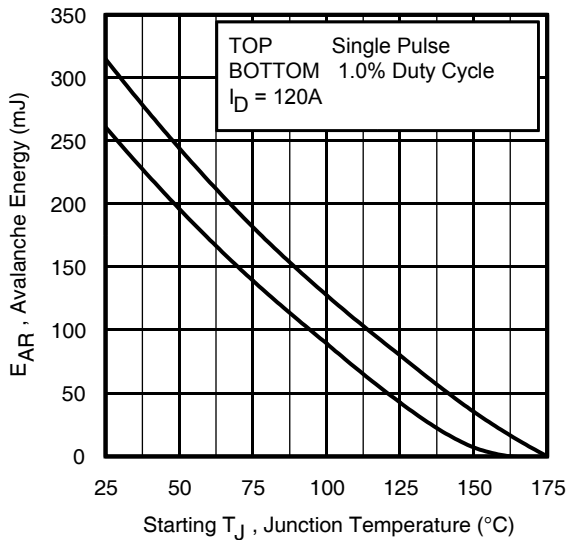
**Fig. 4** Typical On-Resistance vs. Drain Current

**Fig 5.** Transfer Characteristics

**Fig 6.** Normalized On-Resistance vs. Temperature

**Fig. 7** Typical Threshold Voltage vs. Junction Temperature

**Fig. 8.** Typical Source-Drain Diode Forward Voltage

**Fig 9.** Typical Forward Trans conductance vs. Drain Current

**Fig 10.** Typical Capacitance vs. Drain-to-Source Voltage

**Fig 11.** Typical Gate Charge vs. Gate-to-Source Voltage

**Fig 12.** Maximum Drain Current vs. Case Temperature

**Fig 13. Maximum Safe Operating Area**

**Fig 14. Maximum Avalanche Energy vs. Temperature**

**Fig 15. Maximum Effective Transient Thermal Impedance, Junction-to-Case**

**Fig 16. Typical Avalanche Current vs. Pulse Width**

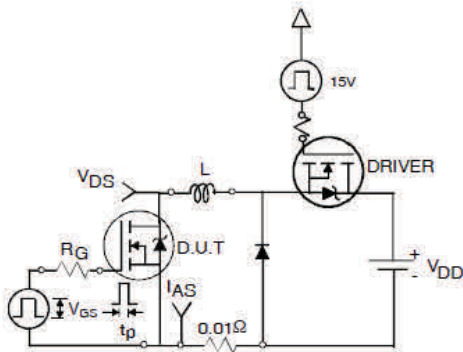
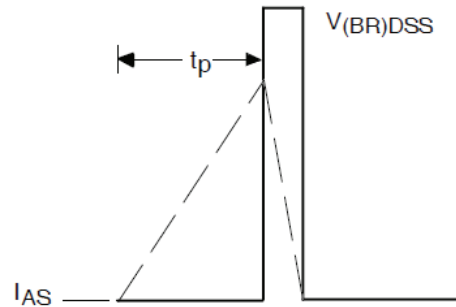
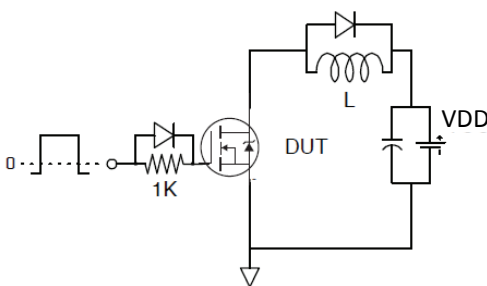
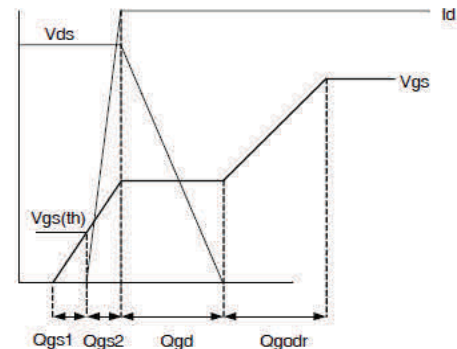
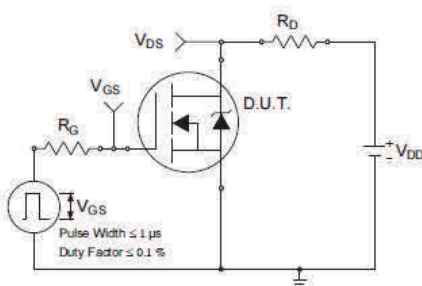
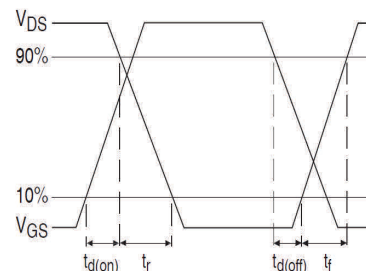

**Fig 17. Maximum Avalanche Energy vs. Temperature**
**Notes on Repetitive Avalanche Curves , Figures 16, 17:**
**(For further info, see AN-1035 at [www.infineon.com](http://www.infineon.com))**

1. Avalanche failures assumption:  
Purely a thermal phenomenon and failure occurs at a temperature far in excess of  $T_{jmax}$ . This is validated for every part type.
2. Safe operation in Avalanche is allowed as long as  $T_{jmax}$  is not exceeded.
3. Equation below based on circuit and waveforms shown in Figures 18a, 18b.
4.  $P_{D(ave)}$  = Average power dissipation per single avalanche pulse.
5.  $BV$  = Rated breakdown voltage (1.3 factor accounts for voltage increase during avalanche).
6.  $I_{av}$  = Allowable avalanche current.
7.  $\Delta T$  = Allowable rise in junction temperature, not to exceed  $T_{jmax}$  (assumed as 25°C in Figure 16, 17).  
 $t_{av}$  = Average time in avalanche.  
 $D$  = Duty cycle in avalanche =  $t_{av} \cdot f$   
 $Z_{thJC}(D, t_{av})$  = Transient thermal resistance, see Figures 15)

$$P_{D(ave)} = 1/2 (1.3 \cdot BV \cdot I_{av}) = \Delta T / Z_{thJC}$$

$$I_{av} = 2\Delta T / [1.3 \cdot BV \cdot Z_{th}]$$

$$E_{AS(AR)} = P_{D(ave)} \cdot t_{av}$$

**Fig 18a. Unclamped Inductive Test Circuit**

**Fig 18b. Unclamped Inductive Waveforms**

**Fig 19a. Gate Charge Test Circuit**

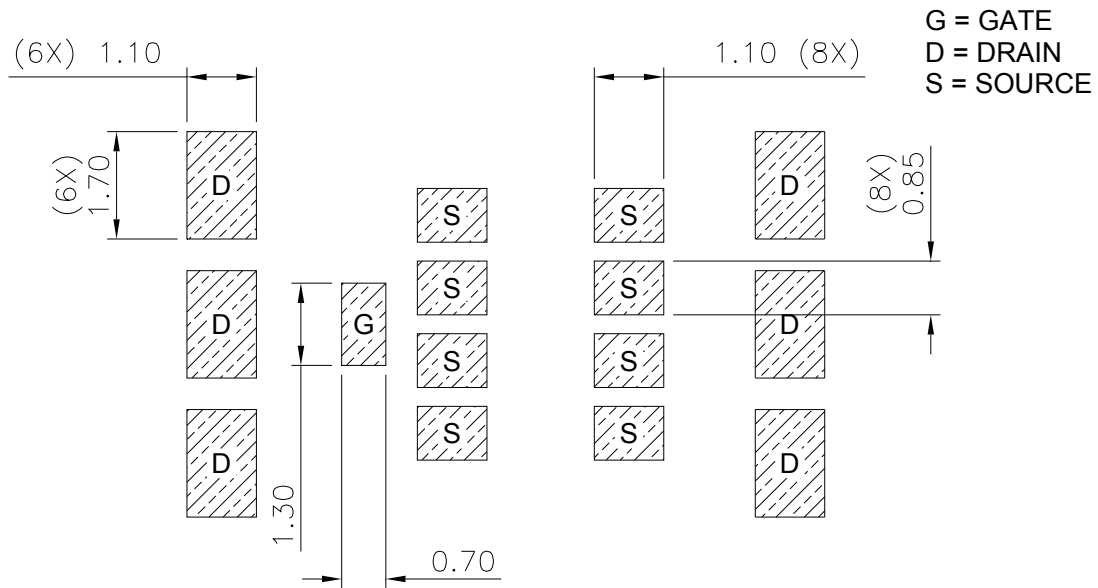
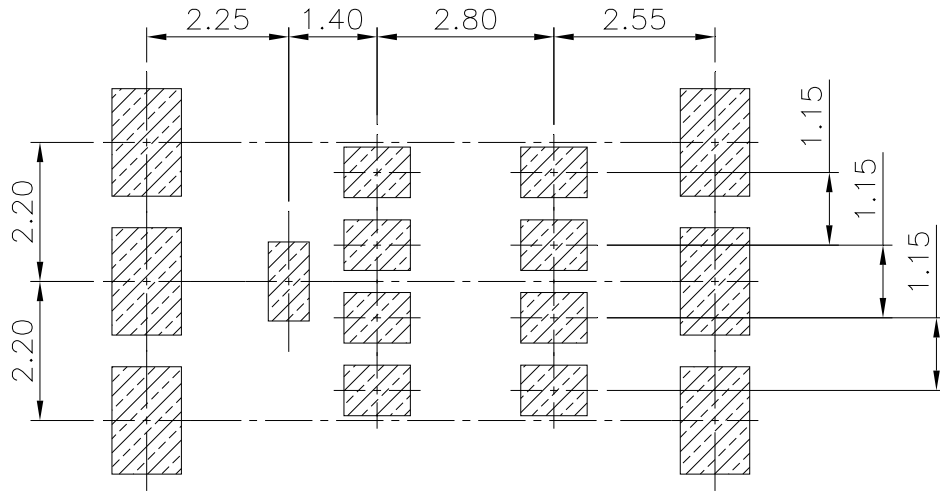
**Fig 19b. Gate Charge Waveform**

**Fig 20a. Switching Time Test Circuit**

**Fig 20b. Switching Time Waveforms**

**DirectFET™ Board Footprint, L8 Outline  
(Large Size Can, 8-Source Pads)**

Please see DirectFET™ application note [AN-1035](#) for all details regarding the assembly of DirectFET™. This includes all recommendations for stencil and substrate designs.





**DirectFET™ Outline Dimension, L8 Outline  
(Large Size Can, 8-Source Pads)**

Please see DirectFET™ application note [AN-1035](#) for all details regarding the assembly of DirectFET™. This includes all recommendations for stencil and substrate designs.

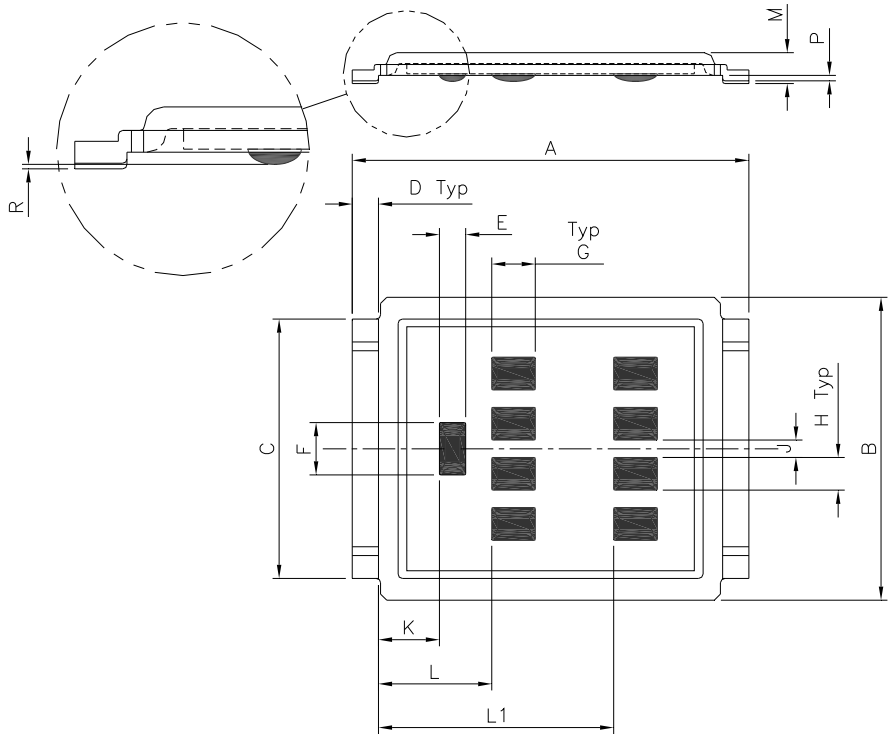

CODE	METRIC		IMPERIAL	
	MIN	MAX	MIN	MAX
A	9.05	9.15	0.356	0.360
B	6.85	7.10	0.270	0.280
C	5.90	6.00	0.232	0.236
D	0.55	0.65	0.022	0.026
E	0.58	0.62	0.023	0.024
F	1.18	1.22	0.046	0.048
G	0.98	1.02	0.039	0.040
H	0.73	0.77	0.029	0.030
J	0.38	0.42	0.015	0.017
K	1.35	1.45	0.053	0.057
L	2.55	2.65	0.100	0.104
L1	5.35	5.45	0.211	0.215
M	0.68	0.74	0.027	0.029
P	0.09	0.17	0.003	0.007
R	0.02	0.08	0.001	0.003

Dimensions are shown in millimeters (inches)

**DirectFET™ Part Marking**

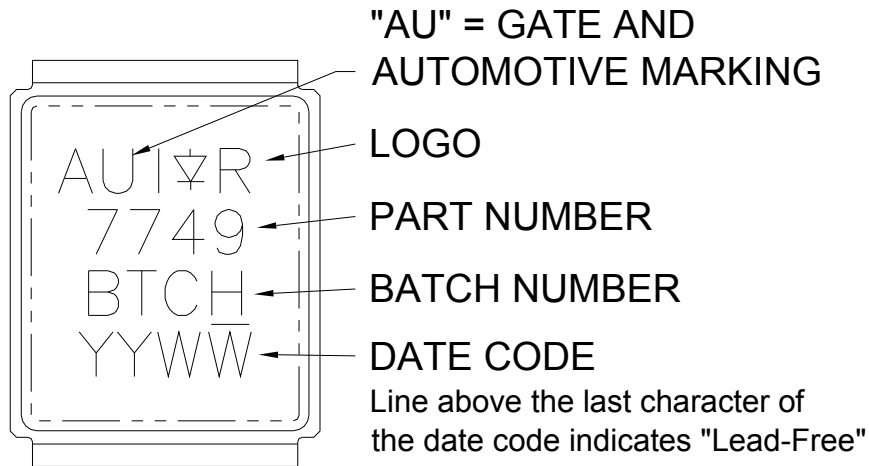

**DirectFET™ Tape & Reel Dimension (Showing component orientation)**

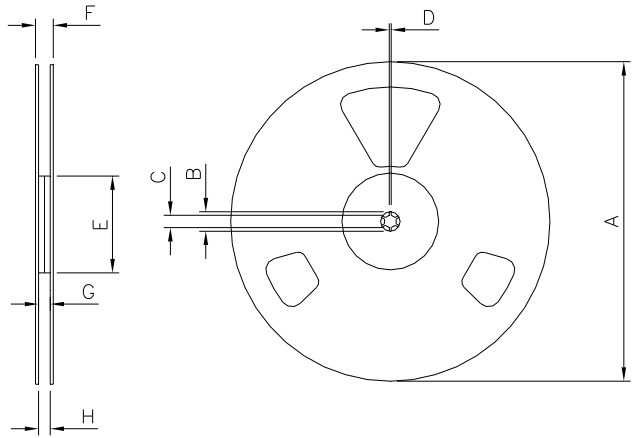

NOTE: Controlling dimensions in mm  
Std reel quantity is 4000 parts. (ordered as AUIRF7749L2TR).

REEL DIMENSIONS				
STANDARD OPTION (QTY 4000)				
CODE	METRIC		IMPERIAL	
	MIN	MAX	MIN	MAX
A	330.00	N.C	12.992	N.C
B	20.20	N.C	0.795	N.C
C	12.80	13.20	0.504	0.520
D	1.50	N.C	0.059	N.C
E	99.00	100.00	3.900	3.940
F	N.C	22.40	N.C	0.880
G	16.40	18.40	0.650	0.720
H	15.90	19.40	0.630	0.760

**LOADED TAPE FEED DIRECTION**

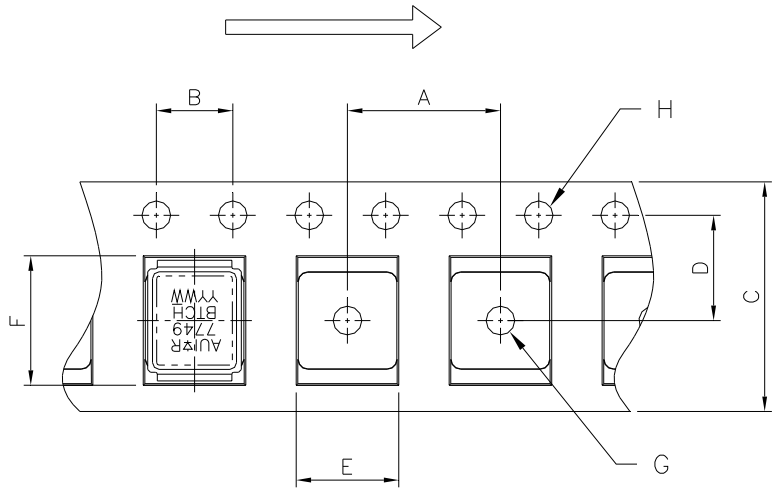

NOTE: CONTROLLING DIMENSIONS IN MM

CODE	METRIC		IMPERIAL	
	MIN	MAX	MIN	MAX
A	11.90	12.10	4.69	0.476
B	3.90	4.10	0.154	0.161
C	15.90	16.30	0.623	0.642
D	7.40	7.60	0.291	0.299
E	7.20	7.40	0.283	0.291
F	9.90	10.10	0.390	0.398
G	1.50	N.C	0.059	N.C
H	1.50	1.60	0.059	0.063

**Qualification Information**

<b>Qualification Level</b>		Automotive (per AEC-Q101)	
		Comments: This part number(s) passed Automotive qualification. Infineon's Industrial and Consumer qualification level is granted by extension of the higher Automotive level.	
<b>Moisture Sensitivity Level</b>		DirectFET2 L-CAN	MSL1
<b>ESD</b>	Machine Model	Class M4 (+/- 800V) <sup>†</sup>	
		AEC-Q101-002	
	Human Body Model	Class H2 (+/- 4000V) <sup>†</sup>	
		AEC-Q101-001	
<b>RoHS Compliant</b>		Yes	

† Highest passing voltage.

- ① Click on this section to link to the appropriate technical paper.
- ② Click on this section to link to the Direct FET™ Website.
- ③ Surface mounted on 1 in. square Cu board, steady state.
- ④  $T_C$  measured with thermocouple mounted to top (Drain) of part.
- ⑤ Repetitive rating; pulse width limited by max. junction temperature.

- ⑥ Limited by  $T_{Jmax}$ , Starting  $T_J = 25^\circ\text{C}$ ,  $L = 0.044\text{mH}$ ,  $R_G = 50\Omega$ ,  $I_{AS} = 120\text{A}$ .
- ⑦ Pulse width  $\leq 400\mu\text{s}$ ; duty cycle  $\leq 2\%$ .
- ⑧ Used double sided cooling, mounting pad with large heat sink.
- ⑨ Mounted on minimum footprint full size board with metalized back and with small clip heat sink.
- ⑩  $R_\theta$  is measured at  $T_J$  of approximately  $90^\circ\text{C}$ .

**Revision History**

Date	Comments
10/11/2016	<ul style="list-style-type: none"> <li>• Changed datasheet with “Infineon” logo –all pages.</li> <li>• Corrected typo on Absolute Maximum Ratings table –from “V<sub>GS</sub>” to “V<sub>DS</sub>” on page 1.</li> <li>• Added disclaimer on last page.</li> </ul>

**Published by**  
**Infineon Technologies AG**  
**81726 München, Germany**  
**© Infineon Technologies AG 2015**  
**All Rights Reserved.**

**IMPORTANT NOTICE**

The information given in this document shall in no event be regarded as a guarantee of conditions or characteristics (“Beschaffenheitsgarantie”). With respect to any examples, hints or any typical values stated herein and/or any information regarding the application of the product, Infineon Technologies hereby disclaims any and all warranties and liabilities of any kind, including without limitation warranties of non-infringement of intellectual property rights of any third party.

In addition, any information given in this document is subject to customer’s compliance with its obligations stated in this document and any applicable legal requirements, norms and standards concerning customer’s products and any use of the product of Infineon Technologies in customer’s applications.

The data contained in this document is exclusively intended for technically trained staff. It is the responsibility of customer’s technical departments to evaluate the suitability of the product for the intended application and the completeness of the product information given in this document with respect to such application.

For further information on the product, technology, delivery terms and conditions and prices please contact your nearest Infineon Technologies office ([www.infineon.com](http://www.infineon.com)).

**WARNINGS**

Due to technical requirements products may contain dangerous substances. For information on the types in question please contact your nearest Infineon Technologies office.

Except as otherwise explicitly approved by Infineon Technologies in a written document signed by authorized representatives of Infineon Technologies, Infineon Technologies’ products may not be used in any applications where a failure of the product or any consequences of the use thereof can reasonably be expected to result in personal injury.