

Features

- Advanced Planar Technology
- Ultra Low On-Resistance
- Logic Level Gate Drive
- Dual N Channel MOSFET
- Surface Mount
- Available in Tape & Reel
- 175°C Operating Temperature
- Lead-Free, RoHS Compliant
- Automotive Qualified *

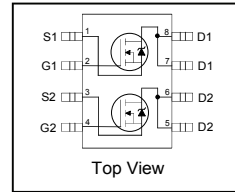

V_{DS}		55V
$R_{DS(on)}$	typ.	0.043Ω
	max.	0.050Ω
I_D		5.1A



G	D	S
Gate	Drain	Source

Description

Specifically designed for Automotive applications, these HEXFET® Power MOSFET's in a Dual SO-8 package utilize the latest processing techniques to achieve extremely low on-resistance per silicon area. Additional features of these Automotive qualified HEXFET Power MOSFET's are a 175°C junction operating temperature, fast switching speed and improved repetitive avalanche rating. These benefits combine to make this design an extremely efficient and reliable device for use in Automotive applications and a wide variety of other applications. The efficient SO-8 package provides enhanced thermal characteristics and dual MOSFET die capability making it ideal in a variety of power applications. This dual, surface mount SO-8 can dramatically reduce board space and is also available in Tape & Reel.

Base part number	Package Type	Standard Pack		Orderable Part Number
		Form	Quantity	
AUIRF7341Q	SO-8	Tape and Reel	4000	AUIRF7341QTR

Absolute Maximum Ratings

Stresses beyond those listed under "Absolute Maximum Ratings" may cause permanent damage to the device. These are stress ratings only; and functional operation of the device at these or any other condition beyond those indicated in the specifications is not implied. Exposure to absolute-maximum-rated conditions for extended periods may affect device reliability. The thermal resistance and power dissipation ratings are measured under board mounted and still air conditions. Ambient temperature (TA) is 25°C, unless otherwise specified.

Symbol	Parameter	Max.	Units
V_{DS}	Drain-Source Voltage	55	V
$I_D @ T_A = 25^\circ C$	Continuous Drain Current, $V_{GS} @ 10V$	5.1	A
$I_D @ T_A = 70^\circ C$	Continuous Drain Current, $V_{GS} @ 10V$	4.2	
I_{DM}	Pulsed Drain Current ①	42	
$P_D @ T_A = 25^\circ C$	Maximum Power Dissipation ③	2.4	W
$P_D @ T_A = 70^\circ C$	Maximum Power Dissipation ③	1.7	
	Linear Derating Factor	16	mW/°C
V_{GS}	Gate-to-Source Voltage	± 20	V
E_{AS}	Single Pulse Avalanche Energy (Thermally Limited) ②	140	mJ
I_{AR}	Avalanche Current	5.1	A
E_{AR}	Repetitive Avalanche Energy	See Fig.17, 18, 15a, 15b	mJ
T_J	Operating Junction and	-55 to + 175	°C
T_{STG}	Storage Temperature Range		

Thermal Resistance

Symbol	Parameter	Typ.	Max.	Units
$R_{\theta JA}$	Junction-to-Ambient ④	—	62.5	°C/W

HEXFET® is a registered trademark of Infineon.

*Qualification standards can be found at www.infineon.com

Static @ T_J = 25°C (unless otherwise specified)

	Parameter	Min.	Typ.	Max.	Units	Conditions
V _{(BR)DSS}	Drain-to-Source Breakdown Voltage	55	—	—	V	V _{GS} = 0V, I _D = 250μA
ΔV _{(BR)DSS} /ΔT _J	Breakdown Voltage Temp. Coefficient	—	0.052	—	V/°C	Reference to 25°C, I _D = 1mA
R _{DS(on)}	Static Drain-to-Source On-Resistance	—	0.043	0.050	Ω	V _{GS} = 10V, I _D = 5.1A ③
		—	0.056	0.065		V _{GS} = 4.5V, I _D = 4.42A ③
V _{GS(th)}	Gate Threshold Voltage	1.0	—	3.0	V	V _{DS} = V _{GS} , I _D = 250μA
g _{fs}	Forward Trans conductance	10.4	—	—	S	V _{DS} = 10V, I _D = 5.2A
I _{DSS}	Drain-to-Source Leakage Current	—	—	2.0	μA	V _{DS} = 44V, V _{GS} = 0V
		—	—	25		V _{DS} = 44V, V _{GS} = 0V, T _J = 150°C
I _{GSS}	Gate-to-Source Forward Leakage	—	—	100	nA	V _{GS} = 20V
	Gate-to-Source Reverse Leakage	—	—	-100		V _{GS} = -20V

Dynamic Electrical Characteristics @ T_J = 25°C (unless otherwise specified)

Q _g	Total Gate Charge	—	29	44	nC	I _D = 5.2A
Q _{gs}	Gate-to-Source Charge	—	2.9	4.4		V _{DS} = 44V
Q _{gd}	Gate-to-Drain Charge	—	7.3	11		V _{GS} = 10V
t _{d(on)}	Turn-On Delay Time	—	9.2	—	ns	V _{DD} = 28V
t _r	Rise Time	—	7.7	—		I _D = 1.0A
t _{d(off)}	Turn-Off Delay Time	—	31	—		R _G = 6.0Ω
t _f	Fall Time	—	12.5	—		V _{GS} = 10V ③
C _{iss}	Input Capacitance	—	780	—	pF	V _{GS} = 0V
C _{oss}	Output Capacitance	—	190	—		V _{DS} = 25V
C _{rss}	Reverse Transfer Capacitance	—	66	—		f = 1.0MHz

Diode Characteristics

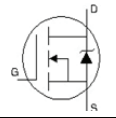
	Parameter	Min.	Typ.	Max.	Units	Conditions
I _S	Continuous Source Current (Body Diode)	—	—	2.4	A	MOSFET symbol showing the integral reverse p-n junction diode. 
I _{SM}	Pulsed Source Current (Body Diode) ①	—	—	42		
V _{SD}	Diode Forward Voltage	—	—	1.2	V	T _J = 25°C, I _S = 2.6A, V _{GS} = 0V ② ③
t _{rr}	Reverse Recovery Time	—	51	77	ns	T _J = 25°C, I _F = 2.6A,
Q _{rr}	Reverse Recovery Charge	—	76	114	nC	di/dt = 100A/μs ③

Notes:

- ① Repetitive rating; pulse width limited by max. junction temperature.
- ② V_{DD} = 25V, Starting T_J = 25°C, L = 10.7mH, R_G = 25Ω, I_{AS} = 5.2A.
- ③ Pulse width ≤ 300μs; duty cycle ≤ 2%.
- ④ Surface mounted FR-4 board, t ≤ 10sec.

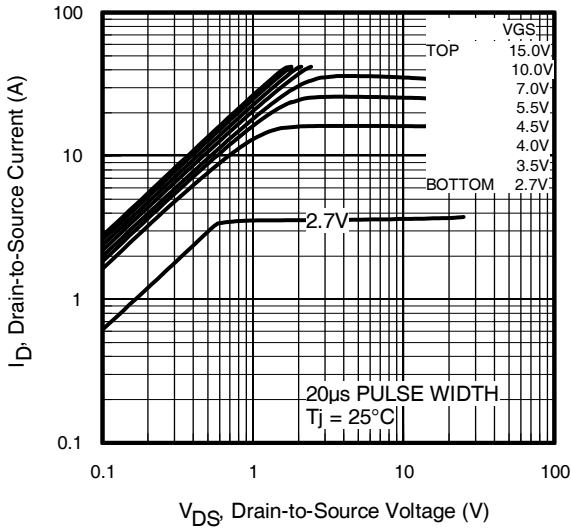
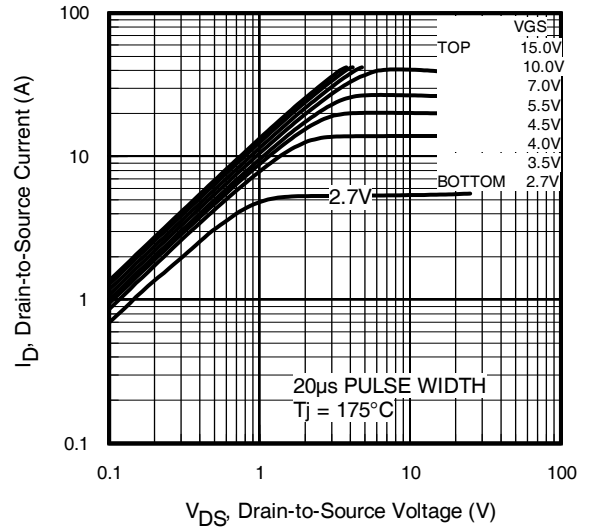
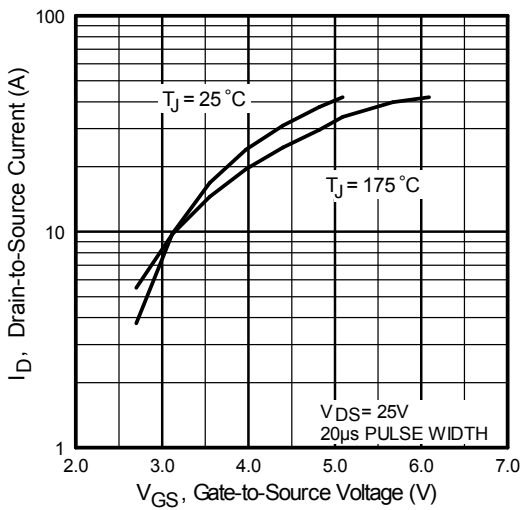
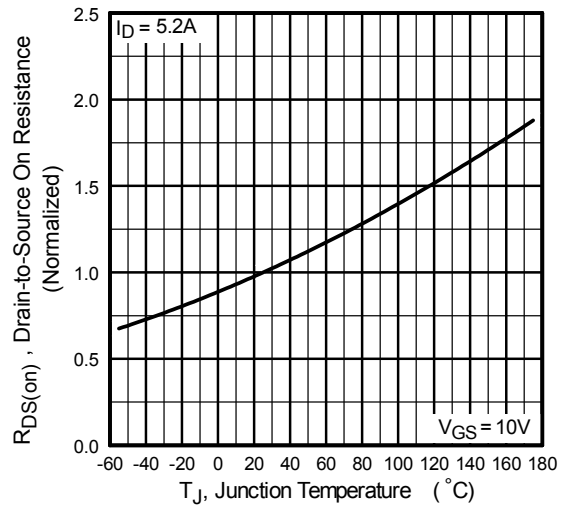
Fig. 1 Typical Output Characteristics

Fig. 2 Typical Output Characteristics

Fig. 3 Typical Transfer Characteristics

Fig. 4 Normalized On-Resistance vs. Temperature

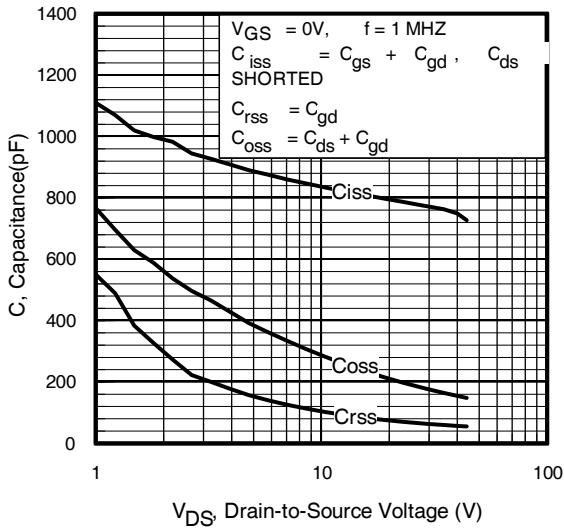

Fig 5. Typical Capacitance vs. Drain-to-Source Voltage

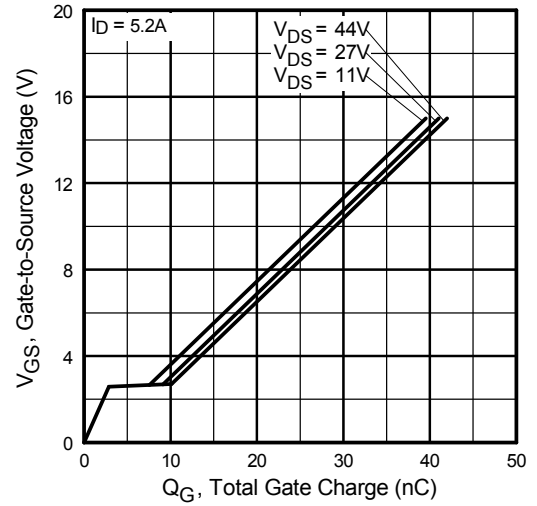

Fig 6. Typical Gate Charge vs. Gate-to-Source Voltage

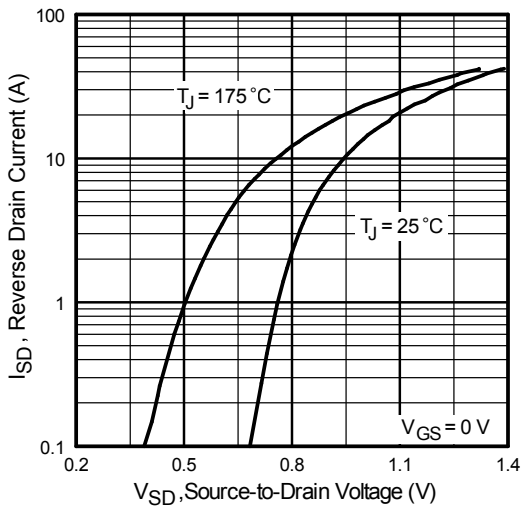

Fig 7. Typical Source-to-Drain Diode Forward Voltage

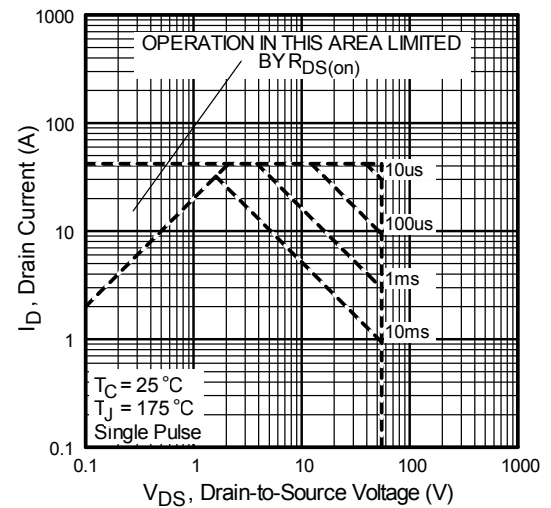
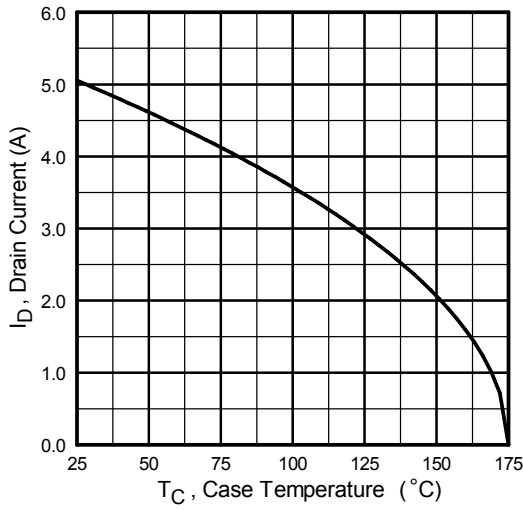
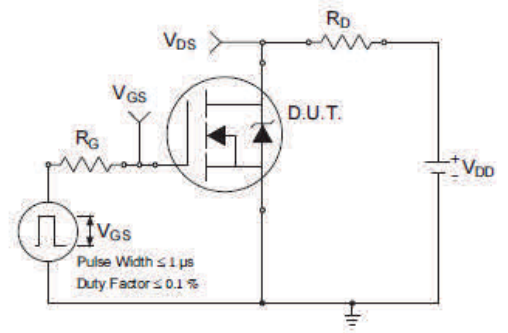
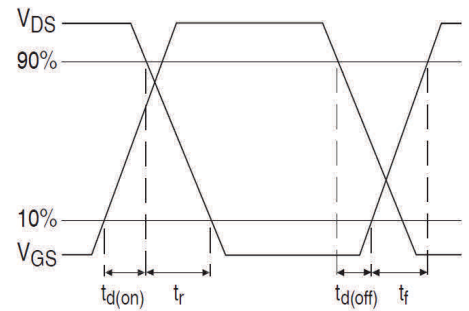
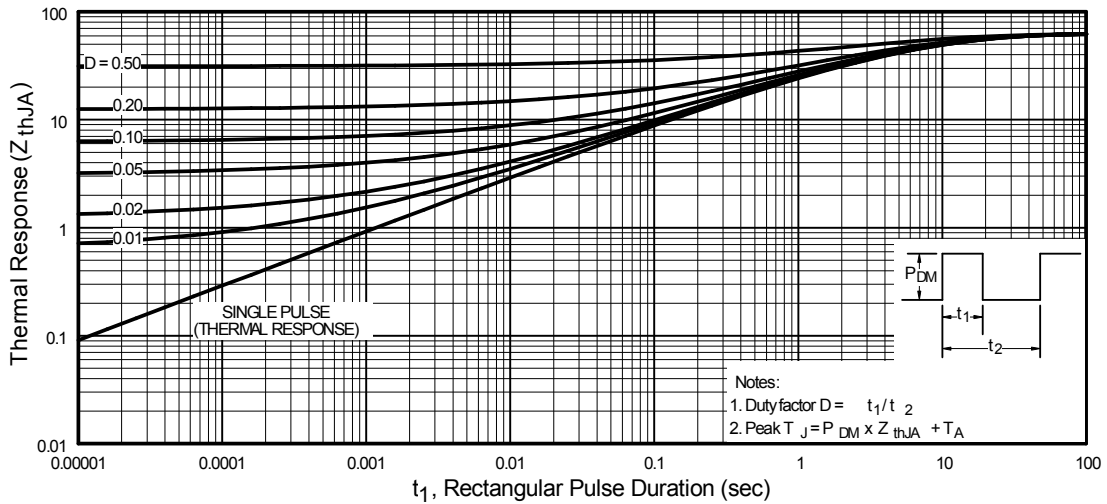
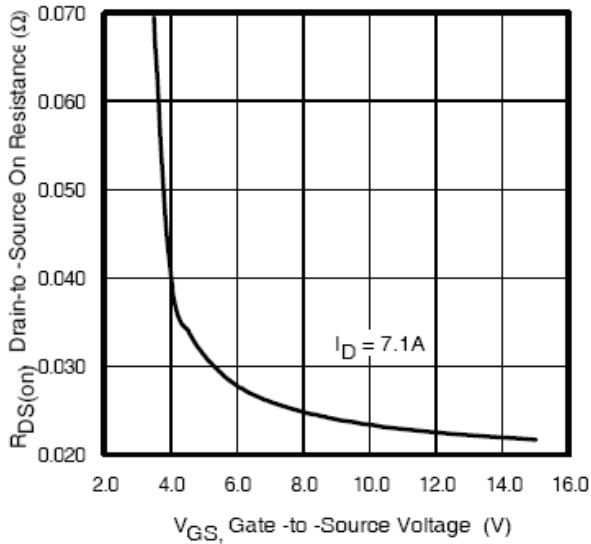
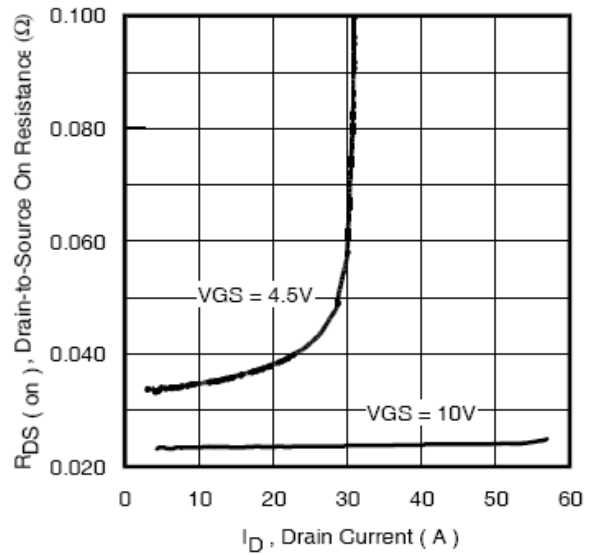
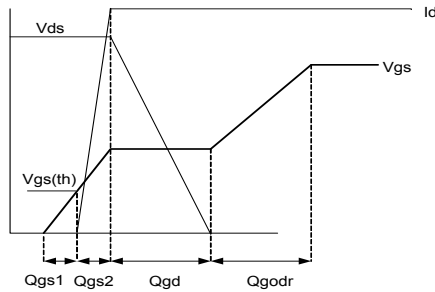
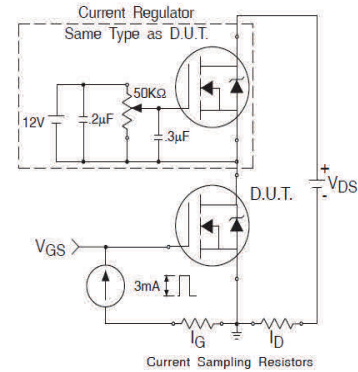
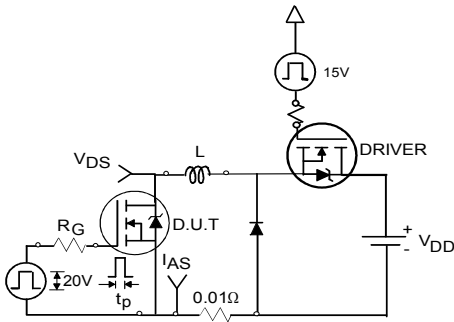
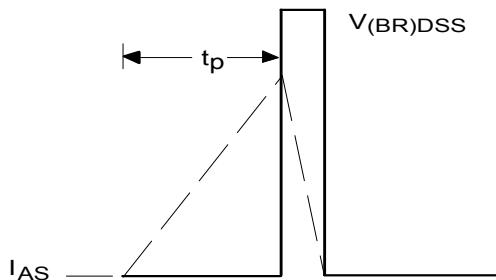
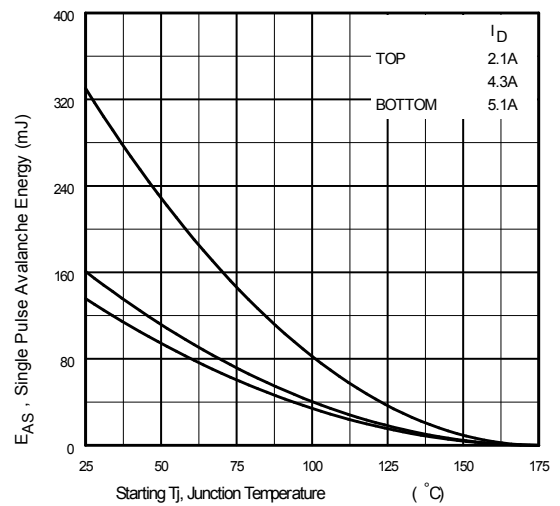
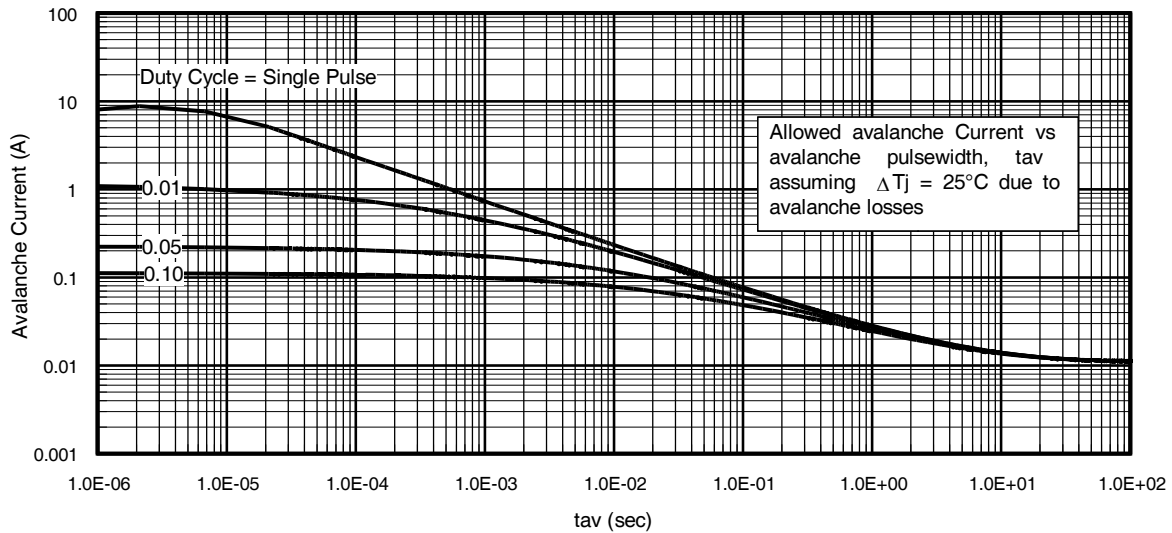
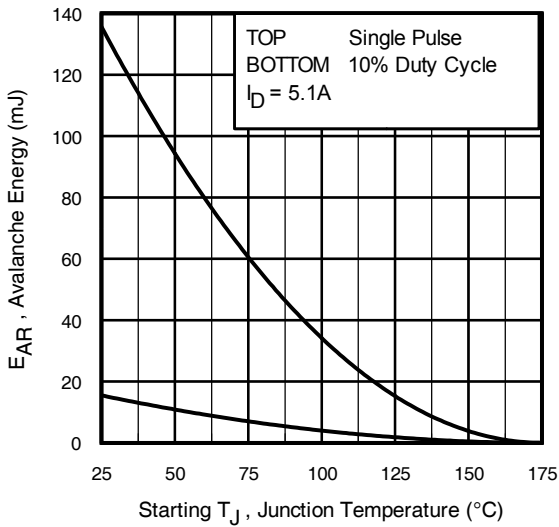

Fig 8. Maximum Safe Operating Area

Fig 9. Maximum Drain Current vs. Case Temperature

Fig 10a. Switching Time Test Circuit

Fig 10b. Switching Time Waveforms

Fig 11. Maximum Effective Transient Thermal Impedance, Junction-to-Ambient

Fig 12. Typical On-Resistance Vs. Gate Voltage

Fig 13. Typical On-Resistance Vs. Drain Current

Fig 14a. Basic Gate Charge Waveform

Fig 14b. Gate Charge Test Circuit

Fig 15a. Unclamped Inductive Test Circuit

Fig 15b. Unclamped Inductive Waveforms

Fig 16. Maximum Avalanche Energy vs. Drain Current

Fig 17. Typical Avalanche Current vs. Pulse width

Fig 18. Maximum Avalanche Energy vs. Temperature
**Notes on Repetitive Avalanche Curves , Figures 17, 18:
(For further info, see AN-1005 at www.infineon.com)**

1. Avalanche failures assumption:
Purely a thermal phenomenon and failure occurs at a temperature far in excess of T_{jmax} . This is validated for every part type.
2. Safe operation in Avalanche is allowed as long as T_{jmax} is not exceeded.
3. Equation below based on circuit and waveforms shown in Figures 15a, 15b.
4. $P_{D(ave)}$ = Average power dissipation per single avalanche pulse.
5. BV = Rated breakdown voltage (1.3 factor accounts for voltage increase during avalanche).
6. I_{av} = Allowable avalanche current.
7. ΔT = Allowable rise in junction temperature, not to exceed T_{jmax} (assumed as 25°C in Figure 11, 17).
 t_{av} = Average time in avalanche.
 D = Duty cycle in avalanche = $t_{av} \cdot f$
 $Z_{thJC}(D, t_{av})$ = Transient thermal resistance, see Figures 11)

$$P_{D(ave)} = 1/2 (1.3 \cdot BV \cdot I_{av}) = \Delta T / Z_{thJC}$$

$$I_{av} = 2\Delta T / [1.3 \cdot BV \cdot Z_{thJC}]$$

$$E_{AS(AR)} = P_{D(ave)} \cdot t_{av}$$

SO-8 Package Outline (Dimensions are shown in millimeters (inches))

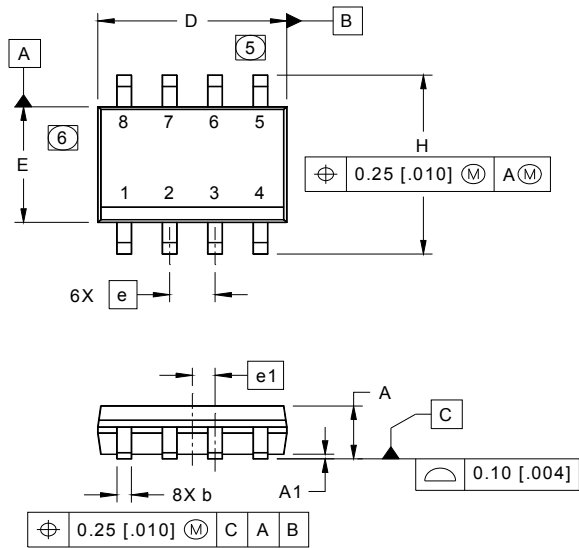

DIM	INCHES		MILLIMETERS	
	MIN	MAX	MIN	MAX
A	.0532	.0688	1.35	1.75
A1	.0040	.0098	0.10	0.25
b	.013	.020	0.33	0.51
c	.0075	.0098	0.19	0.25
D	.189	.1968	4.80	5.00
E	.1497	.1574	3.80	4.00
e	.050 BASIC		1.27 BASIC	
e 1	.025 BASIC		0.635 BASIC	
H	.2284	.2440	5.80	6.20
K	.0099	.0196	0.25	0.50
L	.016	.050	0.40	1.27
y	0°	8°	0°	8°

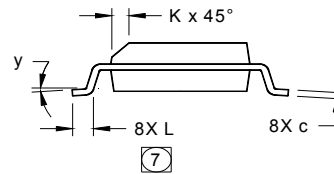

- NOTES:
1. DIMENSIONING & TOLERANCING PER ASME Y14.5M-1994.
 2. CONTROLLING DIMENSION: MILLIMETER
 3. DIMENSIONS ARE SHOWN IN MILLIMETERS [INCHES].
 4. OUTLINE CONFORMS TO JEDEC OUTLINE MS-012AA.
 5. DIMENSION DOES NOT INCLUDE MOLD PROTRUSIONS. MOLD PROTRUSIONS NOT TO EXCEED 0.15 [.006].
 6. DIMENSION DOES NOT INCLUDE MOLD PROTRUSIONS. MOLD PROTRUSIONS NOT TO EXCEED 0.25 [.010].
 7. DIMENSION IS THE LENGTH OF LEAD FOR SOLDERING TO A SUBSTRATE.

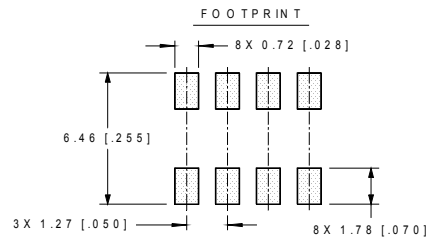

SO-8 Part Marking Information

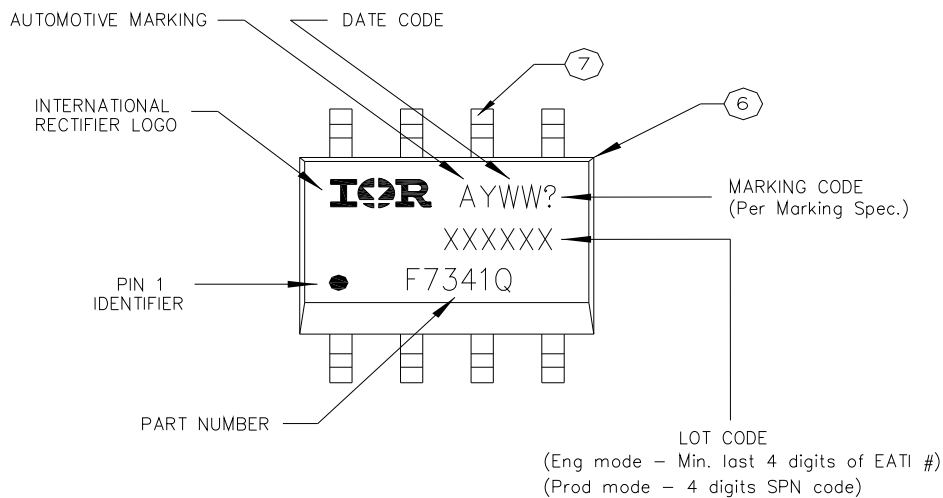

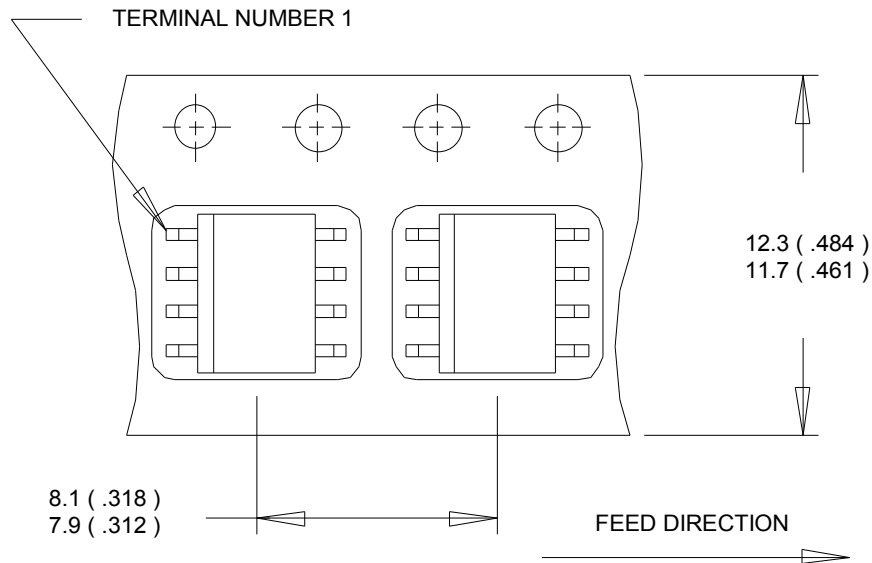
SO-8 Tape and Reel (Dimensions are shown in millimeters (inches))

NOTES:

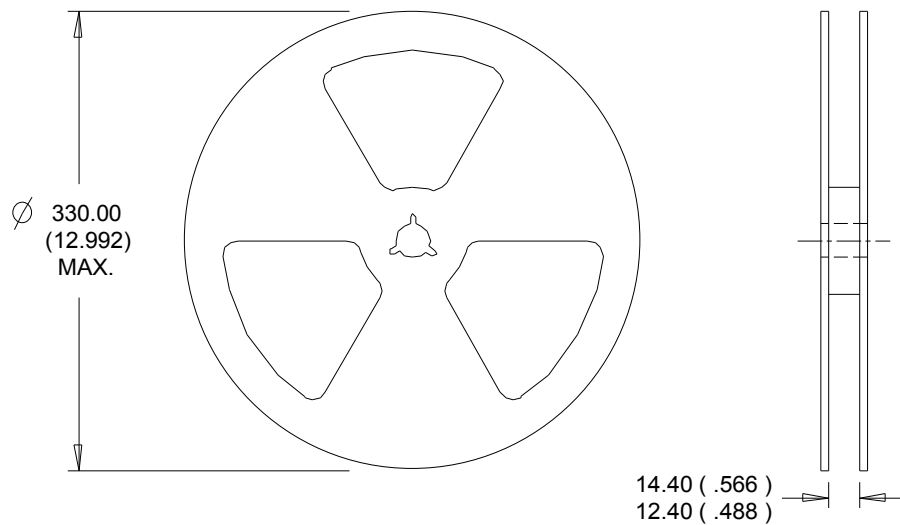
1. CONTROLLING DIMENSION : MILLIMETER.
2. ALL DIMENSIONS ARE SHOWN IN MILLIMETERS(INCHES).
3. OUTLINE CONFORMS TO EIA-481 & EIA-541.

NOTES :

1. CONTROLLING DIMENSION : MILLIMETER.
2. OUTLINE CONFORMS TO EIA-481 & EIA-541.

Qualification Information

Qualification Level		Automotive (per AEC-Q101)	
		Comments: This part number(s) passed Automotive qualification. Infineon's Industrial and Consumer qualification level is granted by extension of the higher Automotive level.	
Moisture Sensitivity Level		SO-8	MSL1
ESD	Machine Model	Class M2 (+/- 200V) [†] AEC-Q101-002	
	Human Body Model	Class H1A (+/- 500V) [†] AEC-Q101-001	
	Charged Device Model	Class C5 (+/- 1125V) [†] AEC-Q101-005	
RoHS Compliant		Yes	

† Highest passing voltage.

Revision History

Date	Comments
3/10/2014	<ul style="list-style-type: none"> Added "Logic Level Gate Drive" bullet in the features section on page 1 Updated data sheet with new IR corporate template
9/30/2015	<ul style="list-style-type: none"> Updated datasheet with corporate template Corrected ordering table on page 1.

Published by
Infineon Technologies AG
81726 München, Germany
 © Infineon Technologies AG 2015
All Rights Reserved.

IMPORTANT NOTICE

The information given in this document shall in no event be regarded as a guarantee of conditions or characteristics ("Beschaffheitsgarantie"). With respect to any examples, hints or any typical values stated herein and/or any information regarding the application of the product, Infineon Technologies hereby disclaims any and all warranties and liabilities of any kind, including without limitation warranties of non-infringement of intellectual property rights of any third party.

In addition, any information given in this document is subject to customer's compliance with its obligations stated in this document and any applicable legal requirements, norms and standards concerning customer's products and any use of the product of Infineon Technologies in customer's applications.

The data contained in this document is exclusively intended for technically trained staff. It is the responsibility of customer's technical departments to evaluate the suitability of the product for the intended application and the completeness of the product information given in this document with respect to such application.

For further information on the product, technology, delivery terms and conditions and prices please contact your nearest Infineon Technologies office (www.infineon.com).

WARNINGS

Due to technical requirements products may contain dangerous substances. For information on the types in question please contact your nearest Infineon Technologies office.

Except as otherwise explicitly approved by Infineon Technologies in a written document signed by authorized representatives of Infineon Technologies, Infineon Technologies' products may not be used in any applications where a failure of the product or any consequences of the use thereof can reasonably be expected to result in personal injury.