

AMMP-6220

6-20 GHz Low Noise Amplifier

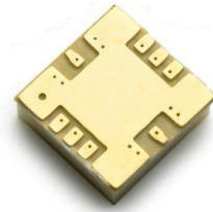

Data Sheet



Description

Avago's AMMP-6220 is a high gain, low-noise amplifier that operates from 6 GHz to 20 GHz. The LNA is designed to be a easy-to-use component for any surface mount PCB application. The broad and unconditionally stable performance makes this LNA ideal for primary, sub-sequential or driver low noise gain stages. Intended applications include microwave radios, 802.16, automotive radar, VSAT, and satellite receivers. Since one part can cover several bands, the AMMP-6220 can reduce part inventory and increase volume purchase options. The LNA has integrated 50 Ω I/O match, DC blocking, self-bias and choke to eliminate complex tuning and assembly processes typically required by hybrid (discrete-FET) amplifiers. The package is full SMT compatible with backside grounding and I/O to simplify assembly.

Features

- 5x5 mm surface mount package
- Broad Band performance 6-20 GHz
- Low 2.5 dB typical noise figure
- High 22 dB typical gain
- 50 Ω input and output match
- Single 3 V (55 mA) supply bias
- 100% RF test in package

Applications

- Microwave radio systems
- Satellite VSAT
- WLL and MMDS loops

Package Diagram

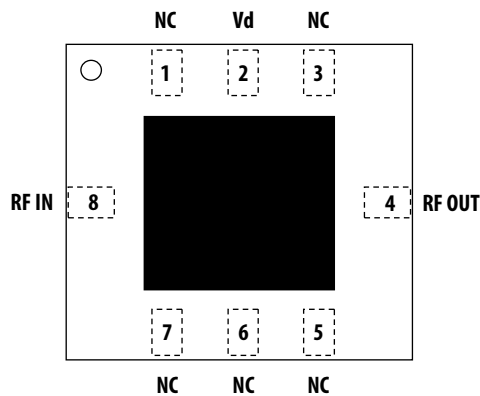

Functional Block Diagram

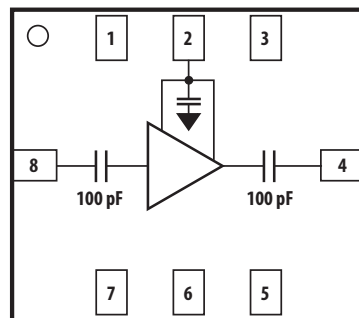

PIN	FUNCTION
1	
2	V _d
3	
4	RF _{out}
5	
6	
7	
8	RF _{in}

PACKAGE
BASE
GND



Attention: Observe precautions for handling electrostatic sensitive devices.
 ESD Machine Model (Class A) = 40V
 ESD Human Body Model (Class 1A) = 300V
 Refer to Avago Application Note A004R:
 Electrostatic Discharge, Damage and Control.

Note: MSL Rating = Level 2A

Electrical Specifications

1. Small/Large -signal data measured in a fully de-embedded test fixture form $T_A = 25^\circ\text{C}$.
2. Pre-assembly into package performance verified 100% on-wafer per AMMC-6220 published specifications.
3. This final package part performance is verified by a functional test correlated to actual performance at one or more frequencies.
4. Specifications are derived from measurements in a 50 W test environment. Aspects of the amplifier performance may be improved over a more narrow bandwidth by application of additional conjugate, linearity, or low noise (Γ_{opt}) matching.

Table 1. RF Electrical Characteristics

Parameter	Min	Typ.	Max	Sigma	Unit
Small-signal Gain, G_a		22		0.5	dB
Noise Figure into 50 Ω , NF		2.5		0.2	dB
Output Power at 1dB Gain Compression, P-1dB		+10		0.8	dBm
Third Order Intercept Point; $\Delta f=100\text{MHz}$; $P_{\text{in}}=-20\text{dBm}$, OIP3		+20		1.1	dBm
Input Return Loss, R_{Lin}		-12		0.3	dB
Output Return Loss, R_{lout}		-16		0.7	dB
Reverse Isolation, I_{sol}		-45		0.5	dB

Table 2. Recommended Operating Range

1. Ambient operational temperature $T_A = 25^\circ\text{C}$ unless otherwise noted.
2. Channel-to-backside Thermal Resistance ($T_{\text{channel}} (T_c) = 34^\circ\text{C}$) as measured using infrared microscopy. Thermal Resistance at backside temperature ($T_b) = 25^\circ\text{C}$ calculated from measured data.

Description	Specifications			Unit	Comments
	Min.	Typical	Max.		
Drain Supply Current, I_d	55	70		mA	($V_d = 3\text{V}$, Under any RF power drive and temperature)

Table 3. Thermal Properties

Parameter	Test Conditions	Value
Thermal Resistance, $\theta_{\text{ch-b}}$		$\theta_{\text{ch-b}} = 27^\circ\text{C/W}$

Absolute Minimum and Maximum Ratings

Table 4. Minimum and Maximum Ratings

Description	Pin	Specifications			Comments
		Min.	Max.	Unit	
Drain Supply Voltage	V_d		7	V	
Drain Current	I_d		100	mA	
RF Input Power (P_{in})	RFIN		15	dBm	CW
Channel Temperature			+150	$^\circ\text{C}$	
Storage Temperature		-65	+150	$^\circ\text{C}$	
Maximum Assembly Temperature			+300	$^\circ\text{C}$	60 second maximum

Notes:

1. Operation in excess of any one of these conditions may result in permanent damage to this device.

Selected performance plots

These measurements are in 50Ω test environment at $T_A = 25^\circ\text{C}$, $V_d = 3\text{V}$, $I_d = 55\text{ mA}$. Aspects of the amplifier performance may be improved over a narrower bandwidth by application of additional conjugate, linearity or low noise (Γ_{opt}) matching.

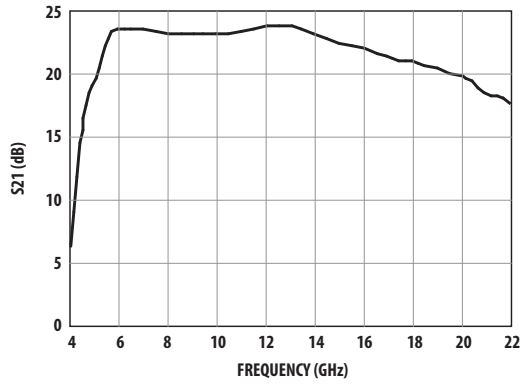

Figure 1. Gain.

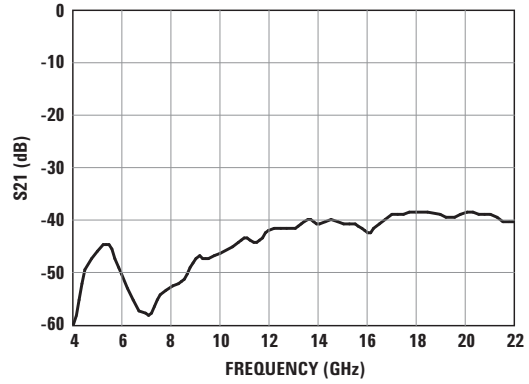

Figure 2. Isolation.

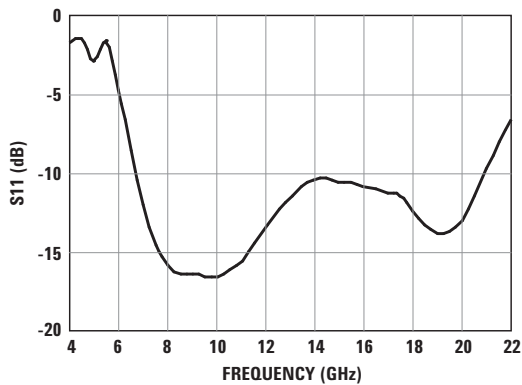

Figure 3. Input return loss.

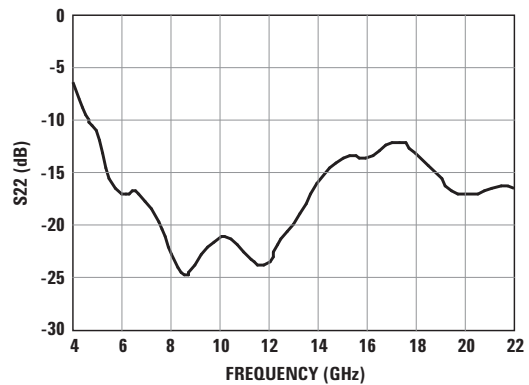

Figure 4. Output return loss.

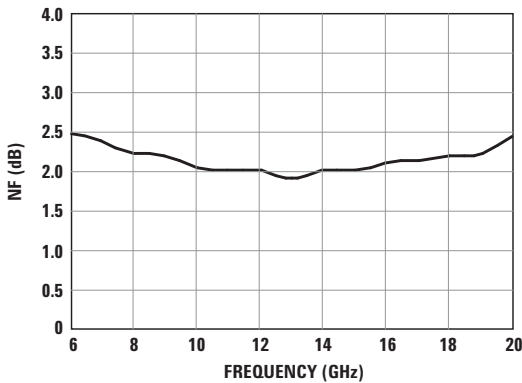

Figure 5. Noise figure.

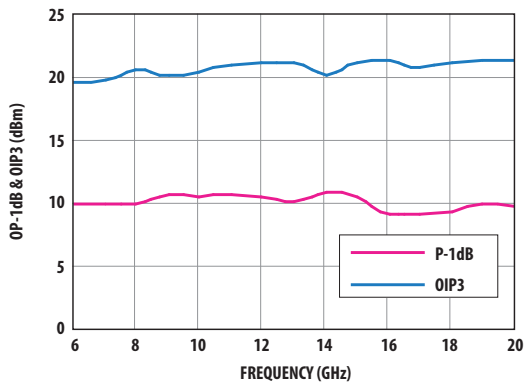

Figure 6. Typical power, OP-1dB and OIP3.

Over Temperature Performance Plots

These measurements are in 50Ω test environment at $T_A = 25^\circ\text{C}$, $V_d = 3\text{V}$, $I_d = 55\text{ mA}$. Aspects of the amplifier performance may be improved over a narrower bandwidth by application of additional conjugate, linearity or low noise (Γ_{opt}) matching.

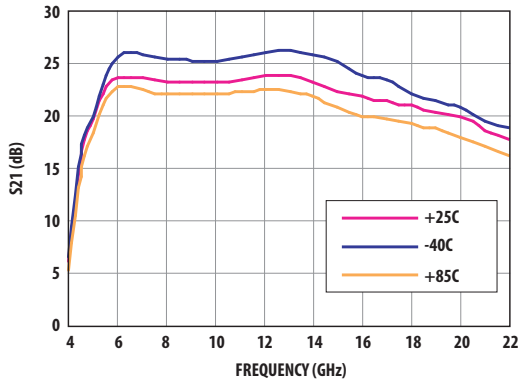

Figure 7. Gain over temperature.

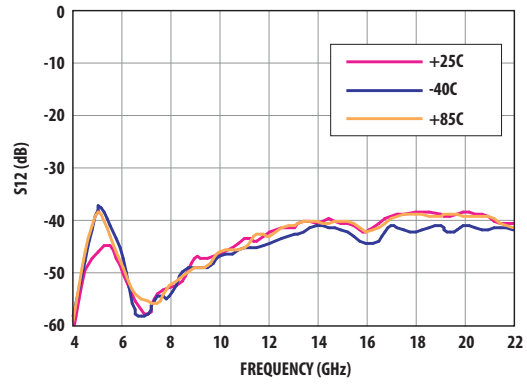

Figure 8. Isolation over temperature.

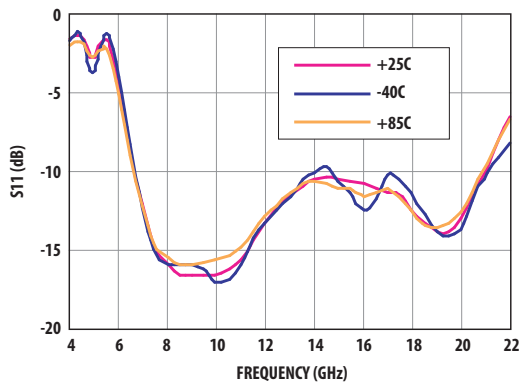

Figure 9. Input return loss over temperature.

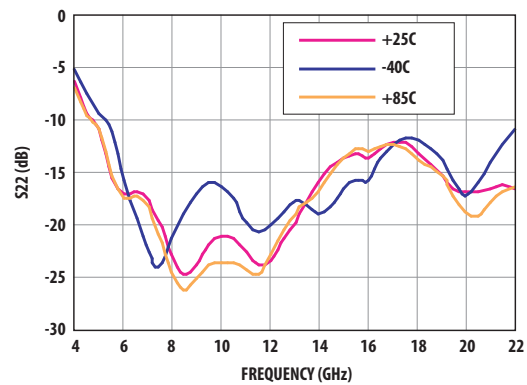

Figure 10. Output return loss over temperature.

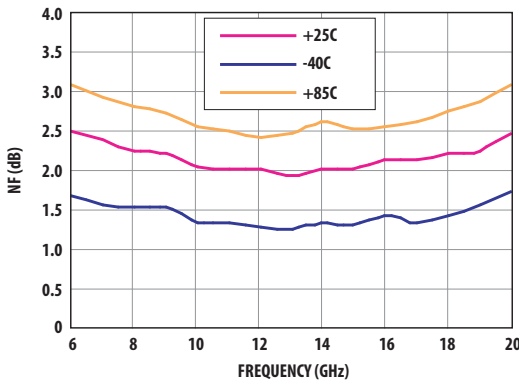

Figure 11. NF over temperature.

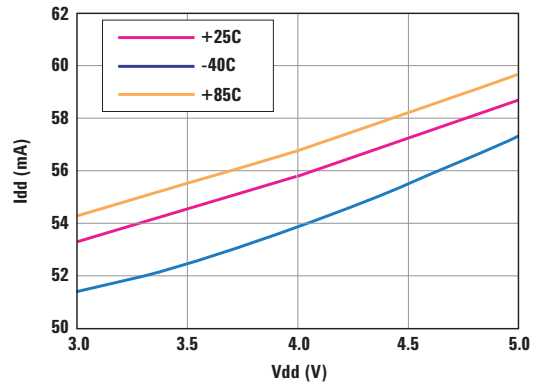

Figure 12. Bias current over temperature.

Over Voltage plots

These measurements are in 50Ω test environment at $T_A = 25^\circ\text{C}$, $V_d = 3\text{V}$, $I_d = 55\text{mA}$. Aspects of the amplifier performance may be improved over a narrower bandwidth by application of additional conjugate, linearity or low noise (Γ_{opt}) matching.

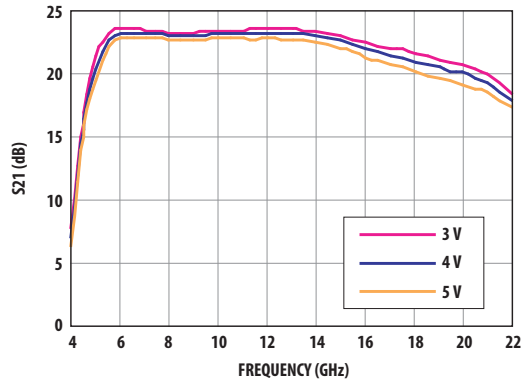

Figure 13. Gain over Vdd.

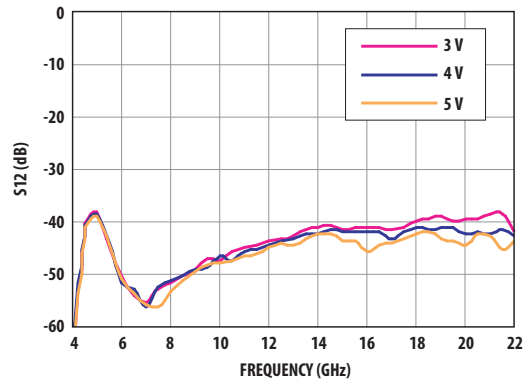

Figure 14. Isolation over Vdd.

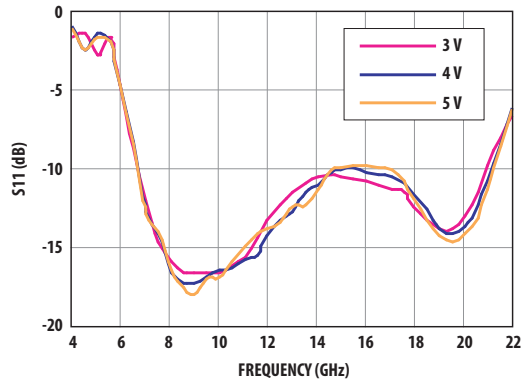

Figure 15. Input RL over Vdd.

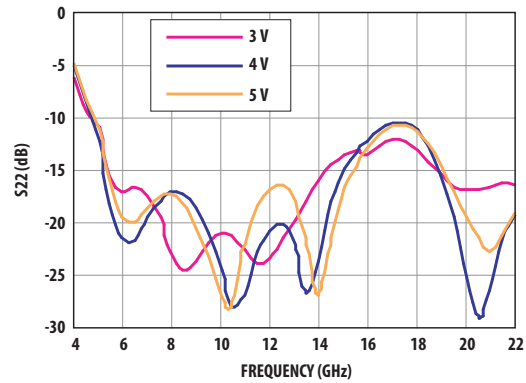

Figure 16. Output return loss over temperature.

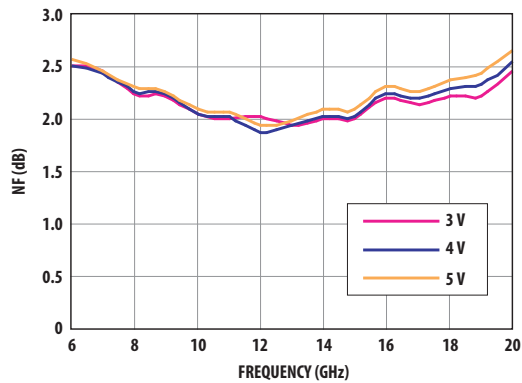

Figure 17. Noise figure over Vdd.

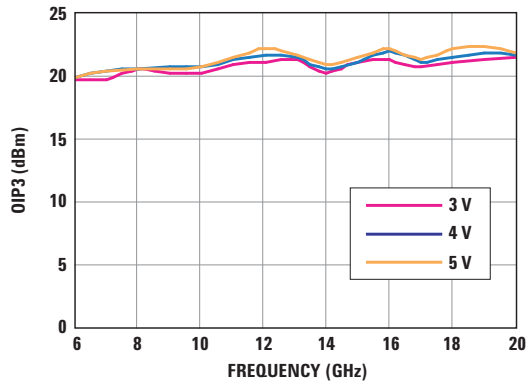

Figure 18. OIP3 over Vdd.

Biasing and Operation

The AMMC-6220 is normally biased with a single positive drain supply connected to both V_D pin through bypass capacitors as shown in Figure 19. The recommended supply voltage is 3 V. It is important to have 0.1 μF bypass capacitor, and the capacitor should be placed as close to the component as possible.

The AMMC-6220 does not require a negative gate voltage to bias any of the three stages. No ground wires are needed because all ground connections are made with plated through-holes to the backside of the package.

Refer the Absolute Maximum Ratings table for allowed DC and thermal conditions.

Application Circuit

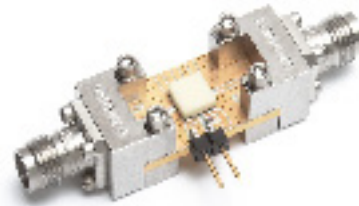
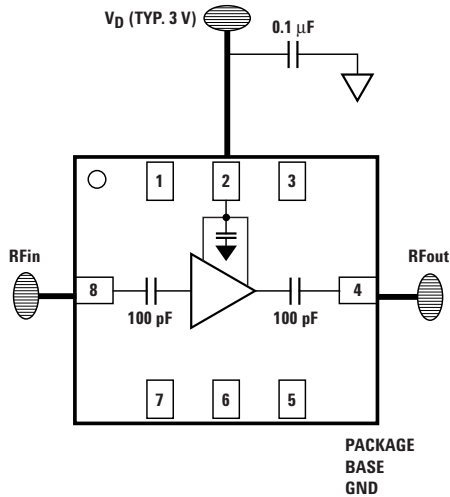

Figure 19. Typical application

Figure 21. Demonstration board (available upon request)

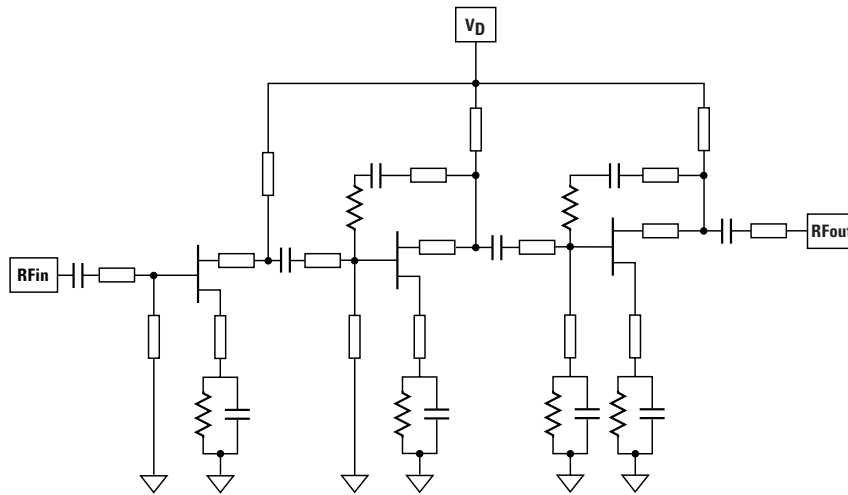

Figure 20. Simplified MMIC schematic

Typical Scattering Parameters

Please refer to <<http://www.avagotech.com>> for typical scattering parameters data.

Package Dimension, PCB Layout and Tape and Reel information

Please refer to Avago Technologies Application Note 5520, AMxP-xxxx production Assembly Process (Land Pattern A).

AMMP-6220 Part Number Ordering Information

Part Number	Devices Per Container	Container
AMMP-6220-BLK	10	Antistatic bag
AMMP-6220-TR1	100	7" Reel
AMMP-6220-TR2	500	7" Reel

For product information and a complete list of distributors, please go to our website: www.avagotech.com

Avago, Avago Technologies, and the A logo are trademarks of Avago Technologies in the United States and other countries.
Data subject to change. Copyright © 2005–2013 Avago Technologies. All rights reserved. Obsoletes 5989-4517EN
AV02-0515EN - July 9, 2013

