

AMC1301-Q1 Precision, ± 250 -mV Input, 3- μ s Delay, Reinforced Isolated Amplifier

1 Features

- Qualified for Automotive Applications
- AEC-Q100 Qualified with the Following Results:
 - Temperature Grade 1: -40°C to 125°C
 - HBM ESD Classification Level 2
 - CDM ESD Classification Level C6
- Low Offset Error and Drift: $\pm 200\ \mu\text{V}$ at 25°C , $\pm 3\ \mu\text{V}/^{\circ}\text{C}$
- Fixed Gain: 8.2
- Very Low Gain Error and Drift: $\pm 0.3\%$ at 25°C , $\pm 50\ \text{ppm}/^{\circ}\text{C}$
- Very Low Nonlinearity and Drift: 0.03%, 1 ppm/ $^{\circ}\text{C}$
- 3.3-V Operation on High-Side and Low-Side
- System-Level Diagnostic Features
- Safety-Related Certifications:
 - 7000- V_{PK} Reinforced Isolation per DIN V VDE V 0884-10 (VDE V 0884-10): 2006-12
 - 5000- V_{RMS} Isolation for 1 Minute per UL1577
 - CAN/CSA No. 5A-Component Acceptance Service Notice

2 Applications

- Shunt-Based Current Sensing or Resistor-Divider-Based Voltage Sensing In:
 - Traction Inverters
 - Onboard Chargers (OBC)
 - DC-DC Converters
 - Battery Management Systems (BMS)

3 Description

The AMC1301-Q1 device is a precision, isolated amplifier with an output separated from the input circuitry by an isolation barrier that is highly resistant to magnetic interference. This barrier is certified to provide reinforced galvanic isolation of up to $7\ \text{kV}_{\text{PEAK}}$ according to VDE V 0884-10 and UL1577. Used in conjunction with isolated power supplies, this device prevents noise currents on a high common-mode voltage line from entering the local ground and interfering with or damaging sensitive circuitry.

The input of the AMC1301-Q1 device is optimized for direct connection to shunt resistors or other low voltage-level signal sources. The excellent performance of the device supports accurate current control resulting in system-level power savings and, especially in motor control applications, lower torque ripple. The integrated common-mode overvoltage and missing high-side supply voltage detection features of the AMC1301-Q1 device simplify system-level design and diagnostics.

The AMC1301-Q1 device is available in a wide-body 8-pin SOIC (DWV) package.

Device Information⁽¹⁾

PART NUMBER	PACKAGE	BODY SIZE (NOM)
AMC1301-Q1	SOIC (8)	5.85 mm x 7.50 mm

(1) For all available packages, see the orderable addendum at the end of the data sheet.

Simplified Schematic

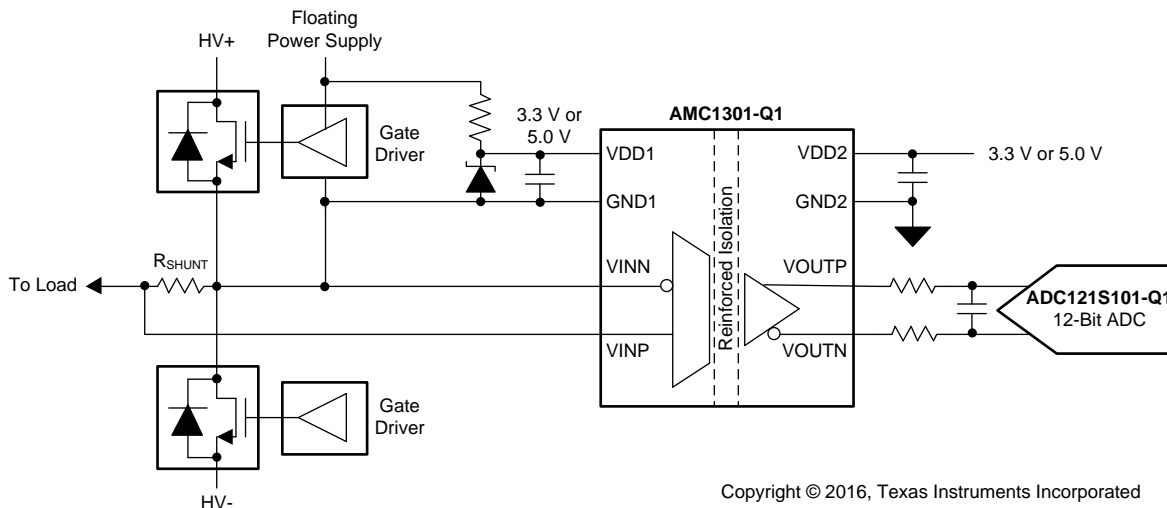

Copyright © 2016, Texas Instruments Incorporated



Table of Contents

<p>1 Features 1</p> <p>2 Applications 1</p> <p>3 Description 1</p> <p>4 Revision History 2</p> <p>5 Pin Configuration and Functions 3</p> <p>6 Specifications 4</p> <p> 6.1 Absolute Maximum Ratings 4</p> <p> 6.2 ESD Ratings 4</p> <p> 6.3 Recommended Operating Conditions 4</p> <p> 6.4 Thermal Information 4</p> <p> 6.5 Power Ratings 4</p> <p> 6.6 Insulation Specifications 5</p> <p> 6.7 Safety-Related Certifications 6</p> <p> 6.8 Safety Limiting Values 6</p> <p> 6.9 Electrical Characteristics 6</p> <p> 6.10 Insulation Characteristics Curves 8</p> <p> 6.11 Typical Characteristics 9</p> <p>7 Parameter Measurement Information 16</p> <p> 7.1 Timing Diagrams 16</p> <p>8 Detailed Description 17</p>	<p> 8.1 Overview 17</p> <p> 8.2 Functional Block Diagram 17</p> <p> 8.3 Feature Description 17</p> <p> 8.4 Device Functional Modes 18</p> <p>9 Application and Implementation 19</p> <p> 9.1 Application Information 19</p> <p> 9.2 Typical Applications 19</p> <p> 9.3 Do's and Don'ts 23</p> <p>10 Power Supply Recommendations 24</p> <p>11 Layout 25</p> <p> 11.1 Layout Guidelines 25</p> <p> 11.2 Layout Example 25</p> <p>12 Device and Documentation Support 26</p> <p> 12.1 Documentation Support 26</p> <p> 12.2 Receiving Notification of Documentation Updates 26</p> <p> 12.3 Community Resources 26</p> <p> 12.4 Trademarks 26</p> <p> 12.5 Electrostatic Discharge Caution 26</p> <p> 12.6 Glossary 26</p> <p>13 Mechanical, Packaging, And Orderable Information 26</p>
---	---

4 Revision History

NOTE: Page numbers for previous revisions may differ from page numbers in the current version.

Changes from Original (April 2017) to Revision A	Page
<ul style="list-style-type: none"> • Changed maximum specification of <i>Supply voltage</i> row in <i>Absolute Maximum Ratings</i> table from 6.5 V to 7 V 4 	

5 Pin Configuration and Functions

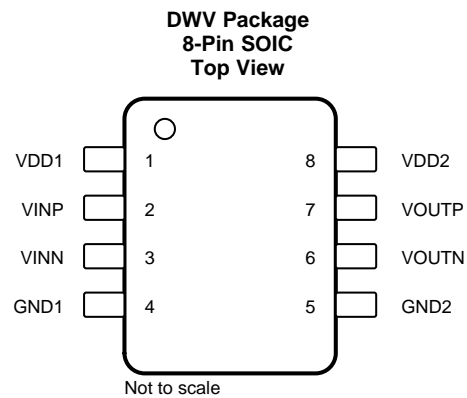

Pin Functions

PIN		I/O	DESCRIPTION
NAME	NO.		
GND1	4	—	High-side analog ground
GND2	5	—	Low-side analog ground
VDD1	1	—	High-side power supply, 3.0 V to 5.5 V. See the Power Supply Recommendations section for decoupling recommendations.
VDD2	8	—	Low-side power supply, 3.0 V to 5.5 V. See the Power Supply Recommendations section for decoupling recommendations.
VINN	3	I	Inverting analog input
VINP	2	I	Noninverting analog input
VOUTN	6	O	Inverting analog output
VOUTP	7	O	Noninverting analog output

6 Specifications

6.1 Absolute Maximum Ratings⁽¹⁾

	MIN	MAX	UNIT
Supply voltage, VDD1 to GND1 or VDD2 to GND2	−0.3	7	V
Analog input voltage at VINP, VINN	GND1 − 6	VDD1 + 0.5	V
Input current to any pin except supply pins	−10	10	mA
Junction temperature, T _J		150	°C
Storage temperature, T _{stg}	−65	150	°C

(1) Stresses beyond those listed under *Absolute Maximum Ratings* may cause permanent damage to the device. These are stress ratings only, which do not imply functional operation of the device at these or any other conditions beyond those indicated under *Recommended Operating Conditions*. Exposure to absolute-maximum-rated conditions for extended periods may affect device reliability.

6.2 ESD Ratings

		VALUE	UNIT
V _(ESD) Electrostatic discharge	Human body model (HBM), per AEC Q100-002 ⁽¹⁾	±2000	V
	Charged device model (CDM), per AEC Q100-011	±1000	

(1) AEC Q100-002 indicates HBM stressing is done in accordance with the ANSI/ESDA/JEDEC JS-001 specification.

6.3 Recommended Operating Conditions

over operating ambient temperature range (unless otherwise noted)

		MIN	NOM	MAX	UNIT
VDD1	High-side supply voltage (VDD1 to GND1)	3.0	5.0	5.5	V
VDD2	Low-side supply voltage (VDD2 to GND2)	3.0	3.3	5.5	V
T _A	Operating ambient temperature	−40		125	°C

6.4 Thermal Information

THERMAL METRIC ⁽¹⁾		AMC1301-Q1	UNIT
		DWV (SOIC)	
		8 PINS	
R _{θJA}	Junction-to-ambient thermal resistance	110.1	°C/W
R _{θJC(top)}	Junction-to-case (top) thermal resistance	51.7	°C/W
R _{θJB}	Junction-to-board thermal resistance	66.4	°C/W
Ψ _{JT}	Junction-to-top characterization parameter	16.0	°C/W
Ψ _{JB}	Junction-to-board characterization parameter	64.5	°C/W
R _{θJC(bot)}	Junction-to-case (bottom) thermal resistance	N/A	°C/W

(1) For more information about traditional and new thermal metrics, see *Semiconductor and IC Package Thermal Metrics*, [SPRA953](#).

6.5 Power Ratings

PARAMETER		TEST CONDITIONS	VALUE	UNIT
P _D	Maximum power dissipation (both sides)	VDD1 = VDD2 = 5.5 V	81.4	mW
P _{D1}	Maximum power dissipation (high-side supply)		45.65	mW
P _{D2}	Maximum power dissipation (low-side supply)		35.75	mW

6.6 Insulation Specifications

over operating ambient temperature range (unless otherwise noted)

PARAMETER		TEST CONDITIONS	VALUE	UNIT
GENERAL				
CLR	External clearance ⁽¹⁾	Shortest pin-to-pin distance through air	≥ 9	mm
CPG	External creepage ⁽¹⁾	Shortest pin-to-pin distance across the package surface	≥ 9	mm
DTI	Distance through insulation	Minimum internal gap (internal clearance) of the double insulation (2 × 0.0135 mm)	≥ 0.027	mm
CTI	Comparative tracking index	DIN EN 60112 (VDE 0303-11); IEC 60112	≥ 600	V
	Material group	According to IEC 60664-1	I	
	Overvoltage category per IEC 60664-1	Rated mains voltage ≤ 300 V _{RMS}	I-IV	
		Rated mains voltage ≤ 600 V _{RMS}	I-III	
		Rated mains voltage ≤ 1000 V _{RMS}	I-II	
DIN V VDE V 0884-10 (VDE V 0884-10): 2006-12⁽²⁾				
V _{IORM}	Maximum repetitive peak isolation voltage	At ac voltage (bipolar)	1500	V _{PK}
V _{IOWM}	Maximum-rated isolation working voltage	At ac voltage (sine wave)	1000	V _{RMS}
		At dc voltage	1500	V _{DC}
V _{IOTM}	Maximum transient isolation voltage	V _{TEST} = V _{IOTM} , t = 60 s (qualification test)	7000	V _{PK}
		V _{TEST} = 1.2 × V _{IOTM} , t = 1 s (100% production test)	8400	
V _{IOSM}	Maximum surge isolation voltage ⁽³⁾	Test method per IEC 60065, 1.2/50-μs waveform, V _{TEST} = 1.6 × V _{IOSM} = 10000 V _{PK} (qualification)	6250	V _{PK}
q _{pd}	Apparent charge ⁽⁴⁾	Method a, after input/output safety test subgroup 2 / 3, V _{ini} = V _{IOTM} , t _{ini} = 60 s, V _{pd(m)} = 1.2 × V _{IORM} = 1800 V _{PK} , t _m = 10 s	≤ 5	pC
		Method a, after environmental tests subgroup 1, V _{ini} = V _{IOTM} , t _{ini} = 60 s, V _{pd(m)} = 1.6 × V _{IORM} = 2400 V _{PK} , t _m = 10 s	≤ 5	
		Method b1, at routine test (100% production) and preconditioning (type test), V _{ini} = V _{IOTM} , t _{ini} = 1 s, V _{pd(m)} = 1.875 × V _{IORM} = 2812.5 V _{PK} , t _m = 1 s	≤ 5	
C _{IO}	Barrier capacitance, input to output ⁽⁵⁾	V _{IO} = 0.5 V _{PP} at 1 MHz	1.2	pF
R _{IO}	Insulation resistance, input to output ⁽⁵⁾	V _{IO} = 500 V at T _S = 150°C	> 10 ⁹	Ω
	Pollution degree		2	
	Climatic category		40/125/21	
UL1577				
V _{ISO}	Withstand isolation voltage	V _{TEST} = V _{ISO} = 5000 V _{RMS} or 7000 V _{DC} , t = 60 s (qualification), V _{TEST} = 1.2 × V _{ISO} = 6000 V _{RMS} , t = 1 s (100% production test)	5000	V _{RMS}

- (1) Apply creepage and clearance requirements according to the specific equipment isolation standards of an application. Care must be taken to maintain the creepage and clearance distance of a board design to ensure that the mounting pads of the isolator on the printed circuit board (PCB) do not reduce this distance. Creepage and clearance on a PCB become equal in certain cases. Techniques such as inserting grooves and ribs on the PCB are used to help increase these specifications.
- (2) This coupler is suitable for *safe electrical insulation* only within the safety ratings. Compliance with the safety ratings shall be ensured by means of suitable protective circuits.
- (3) Testing is carried out in air or oil to determine the intrinsic surge immunity of the isolation barrier.
- (4) Apparent charge is electrical discharge caused by a partial discharge (pd).
- (5) All pins on each side of the barrier are tied together, creating a two-pin device.

6.7 Safety-Related Certifications

VDE	UL
Certified according to DIN V VDE V 0884-10 (VDE V 0884-10): 2006-12, DIN EN 60950-1 (VDE 0805 Teil 1): 2014-08, and DIN EN 60065 (VDE 0860): 2005-11	Recognized under 1577 component recognition and CSA component acceptance NO 5 programs
Reinforced insulation	Single protection
Certificate number: 40040142	File number: E181974

6.8 Safety Limiting Values

Safety limiting intends to prevent potential damage to the isolation barrier upon failure of input or output (I/O) circuitry. A failure of the I/O may allow low resistance to ground or the supply and, without current limiting, dissipate sufficient power to overheat the die and damage the isolation barrier, potentially leading to secondary system failures.

PARAMETER	TEST CONDITIONS	MIN	TYP	MAX	UNIT
I _S Safety input, output, or supply current	$\theta_{JA} = 110.1^{\circ}\text{C/W}$, $V_I = 5.5\text{ V}$, $T_J = 150^{\circ}\text{C}$, $T_A = 25^{\circ}\text{C}$			206	mA
	$\theta_{JA} = 110.1^{\circ}\text{C/W}$, $V_I = 3.6\text{ V}$, $T_J = 150^{\circ}\text{C}$, $T_A = 25^{\circ}\text{C}$			315	
P _S Safety input, output, or total power	$\theta_{JA} = 110.1^{\circ}\text{C/W}$, $T_J = 150^{\circ}\text{C}$, $T_A = 25^{\circ}\text{C}$			1135 ⁽¹⁾	mW
T _S Maximum safety temperature				150	°C

(1) Input, output, or the sum of input and output power must not exceed this value.

The maximum safety temperature is the maximum junction temperature specified for the device. The power dissipation and junction-to-air thermal impedance of the device installed in the application hardware determines the junction temperature. The assumed junction-to-air thermal resistance in the [Thermal Information](#) table is that of a device installed on a high-K test board for leaded surface-mount packages. The power is the recommended maximum input voltage times the current. The junction temperature is then the ambient temperature plus the power times the junction-to-air thermal resistance.

6.9 Electrical Characteristics

Minimum and maximum specifications apply from $T_A = -40^{\circ}\text{C}$ to $+125^{\circ}\text{C}$, $V_{DD1} = 3.0\text{ V}$ to 5.5 V , $V_{DD2} = 3.0\text{ V}$ to 5.5 V , $V_{INP} = -250\text{ mV}$ to $+250\text{ mV}$, and $V_{INN} = 0\text{ V}$. Typical specifications are at $T_A = 25^{\circ}\text{C}$, $V_{DD1} = 5\text{ V}$, and $V_{DD2} = 3.3\text{ V}$ (unless otherwise noted).

PARAMETER	TEST CONDITIONS	MIN	TYP	MAX	UNIT
ANALOG INPUT					
V _{Clipping} Differential input voltage before clipping output	V _{INP} – V _{INN}		±302.7		mV
V _{FSR} Specified linear differential full-scale	V _{INP} – V _{INN}	–250		250	mV
V _{CM} Specified common-mode input voltage	(V _{INP} + V _{INN}) / 2 to GND1	–0.16	V _{DD1} – 2.1		V
	Absolute common-mode input voltage ⁽¹⁾	–2		V _{DD1}	V
V _{CMov} Common-mode overvoltage detection level		V _{DD1} – 2			V
V _{OS} Input offset voltage	Initial, at $T_A = 25^{\circ}\text{C}$, V _{INP} = V _{INN} = GND1	–200	±50	200	μV
TCV _{OS} Input offset drift		–3	±1	3	μV/°C
CMRR Common-mode rejection ratio	$f_{IN} = 0\text{ Hz}$, $V_{CM\ min} \leq V_{CM} \leq V_{CM\ max}$		–93		dB
	$f_{IN} = 10\text{ kHz}$, $V_{CM\ min} \leq V_{CM} \leq V_{CM\ max}$		–93		
C _{IND} Differential input capacitance			1		pF
R _{IN} Single-ended input resistance	V _{INN} = GND1		18		kΩ
R _{IND} Differential input resistance			22		kΩ
I _{IB} Input bias current	V _{INP} = V _{INN} = GND1	–82	–60	–48	μA
TCI _{IB} Input bias current drift			1		nA/°C
BW _{IN} Input bandwidth			1000		kHz

(1) Steady-state voltage supported by the device in case of a system failure. See specified common-mode input voltage V_{CM} for normal operation. Observe analog input voltage range as specified in [Absolute Maximum Ratings](#).

Electrical Characteristics (continued)

Minimum and maximum specifications apply from $T_A = -40^\circ\text{C}$ to $+125^\circ\text{C}$, $V_{DD1} = 3.0\text{ V}$ to 5.5 V , $V_{DD2} = 3.0\text{ V}$ to 5.5 V , $V_{INP} = -250\text{ mV}$ to $+250\text{ mV}$, and $V_{INN} = 0\text{ V}$. Typical specifications are at $T_A = 25^\circ\text{C}$, $V_{DD1} = 5\text{ V}$, and $V_{DD2} = 3.3\text{ V}$ (unless otherwise noted).

PARAMETER		TEST CONDITIONS	MIN	TYP	MAX	UNIT
ANALOG OUTPUT						
	Nominal gain			8.2		
E_G	Gain error	Initial, at $T_A = 25^\circ\text{C}$	-0.3%	$\pm 0.05\%$	0.3%	
TCE_G	Gain error drift		-50	± 15	50	ppm/ $^\circ\text{C}$
	Nonlinearity		-0.03%	$\pm 0.01\%$	0.03%	
	Nonlinearity drift			1		ppm/ $^\circ\text{C}$
THD	Total harmonic distortion	$f_{IN} = 10\text{ kHz}$		-87		dB
	Output noise	$V_{INP} = V_{INN} = \text{GND1}$, $f_{IN} = 0\text{ Hz}$, $BW = 100\text{ kHz}$		220		μV_{RMS}
SNR	Signal-to-noise ratio	$f_{IN} = 1\text{ kHz}$, $BW = 10\text{ kHz}$	80	84		dB
		$f_{IN} = 10\text{ kHz}$, $BW = 100\text{ kHz}$		71		
PSRR	Power-supply rejection ratio	vs V_{DD1} , at dc		-94		dB
		vs V_{DD1} , 100-mV and 10-kHz ripple		-90		
		vs V_{DD2} , at dc		-100		
		vs V_{DD2} , 100-mV and 10-kHz ripple		-94		
t_r	Rise time	See Figure 45		2.0		μs
t_f	Fall time	See Figure 45		2.0		μs
	V_{IN} to V_{OUT} signal delay (50% – 10%)	See Figure 46 , unfiltered output		0.7	2.0	μs
	V_{IN} to V_{OUT} signal delay (50% – 50%)	See Figure 46 , unfiltered output		1.6	2.6	μs
	V_{IN} to V_{OUT} signal delay (50% – 90%)	See Figure 46 , unfiltered output		2.5	3.0	μs
CMTI	Common-mode transient immunity	$ \text{GND1} - \text{GND2} = 1\text{ kV}$	15			kV/ μs
V_{CMout}	Common-mode output voltage		1.39	1.44	1.49	V
	Output short-circuit current			± 13		mA
R_{OUT}	Output resistance	on V_{OUTP} or V_{OUTN}		< 0.2		Ω
BW	Output bandwidth		190	210		kHz
V_{FAILSAFE}	Failsafe differential output voltage	$V_{\text{CM}} \geq V_{\text{CMov}}$, or V_{DD1} missing		-2.563	-2.545	V
POWER SUPPLY						
I_{DD1}	High-side supply current	$3.0\text{ V} \leq V_{\text{DD1}} \leq 3.6\text{ V}$		5.0	6.9	mA
		$4.5\text{ V} \leq V_{\text{DD1}} \leq 5.5\text{ V}$		5.9	8.3	
I_{DD2}	Low-side supply current	$3.0\text{ V} \leq V_{\text{DD2}} \leq 3.6\text{ V}$		4.4	5.6	mA
		$4.5\text{ V} \leq V_{\text{DD2}} \leq 5.5\text{ V}$		4.8	6.5	
P_{DD1}	High-side power dissipation	$3.0\text{ V} \leq V_{\text{DD1}} \leq 3.6\text{ V}$		16.5	24.84	mW
		$4.5\text{ V} \leq V_{\text{DD1}} \leq 5.5\text{ V}$		29.5	45.65	
P_{DD2}	Low-side power dissipation	$3.0\text{ V} \leq V_{\text{DD2}} \leq 3.6\text{ V}$		14.52	20.16	mW
		$4.5\text{ V} \leq V_{\text{DD2}} \leq 5.5\text{ V}$		24	35.75	

6.10 Insulation Characteristics Curves

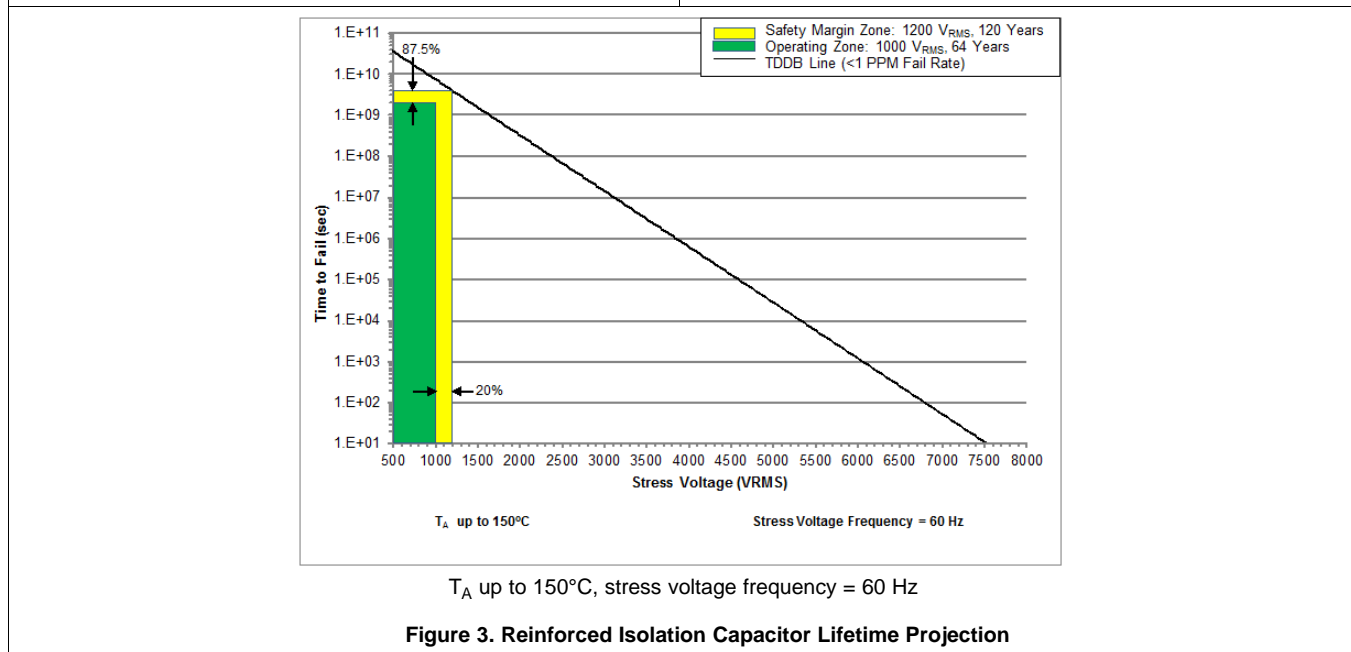
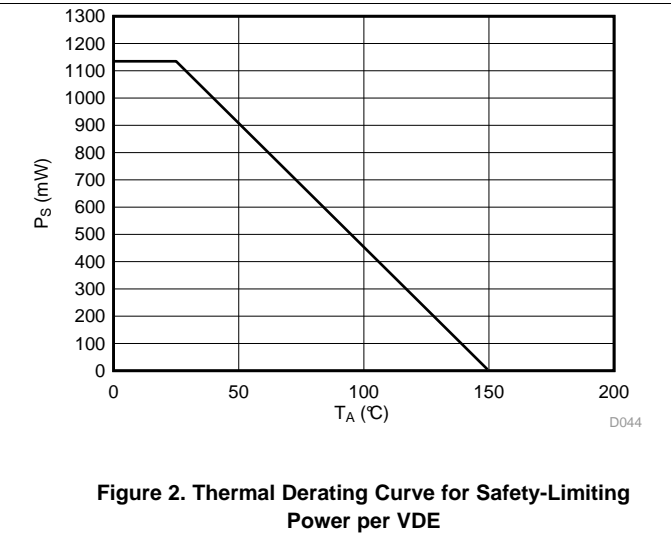
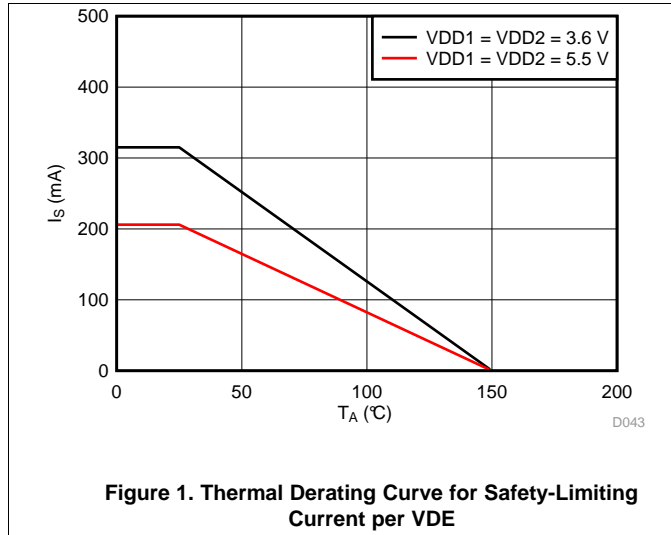

6.11 Typical Characteristics

at VDD1 = 5 V, VDD2 = 3.3 V, VINP = -250 mV to 250 mV, VINN = 0 V, and f_{IN} = 10 kHz (unless otherwise noted)

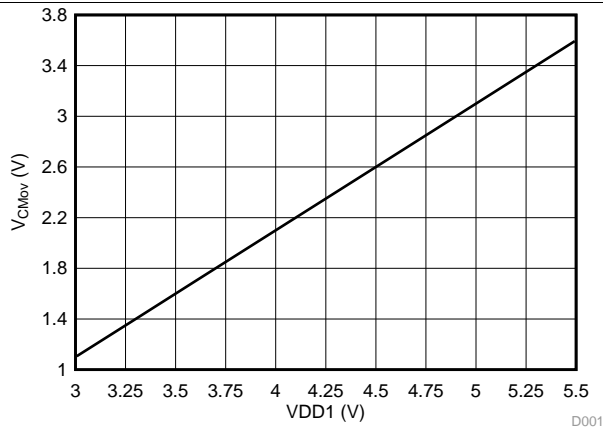

Figure 4. Common-Mode Overvoltage Detection Level vs High-Side Supply Voltage

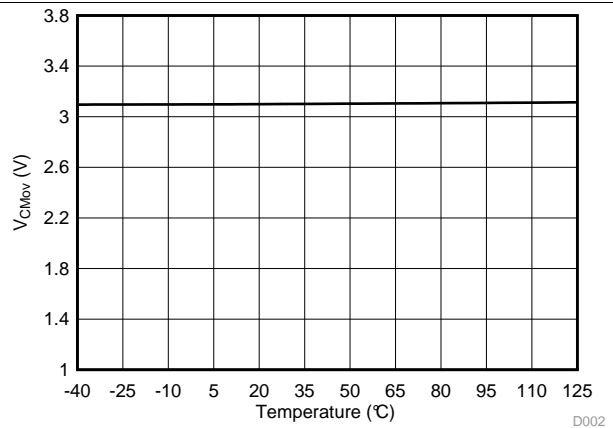
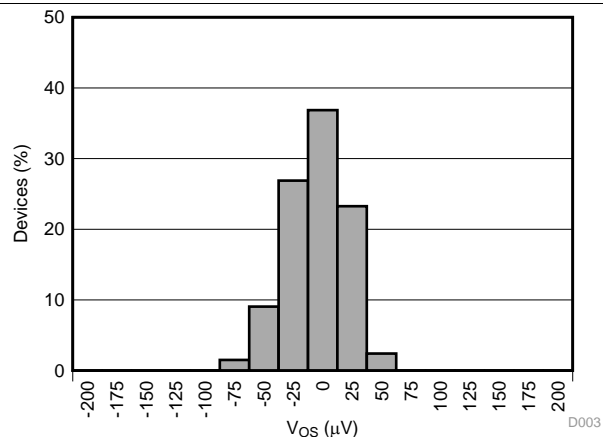
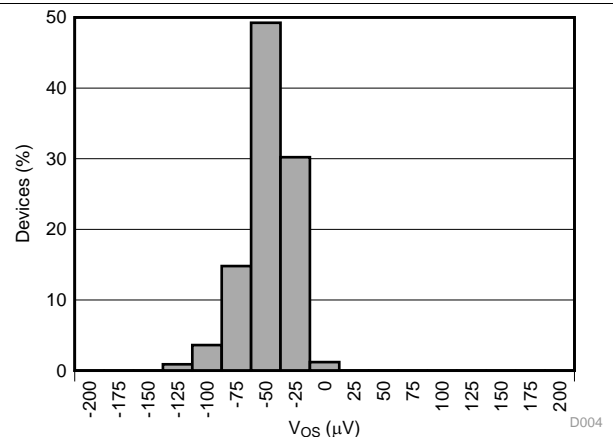

Figure 5. Common-Mode Overvoltage Detection Level vs Temperature



VDD1 = 3.3 V

Figure 6. Input Offset Voltage Histogram



VDD1 = 5 V

Figure 7. Input Offset Voltage Histogram

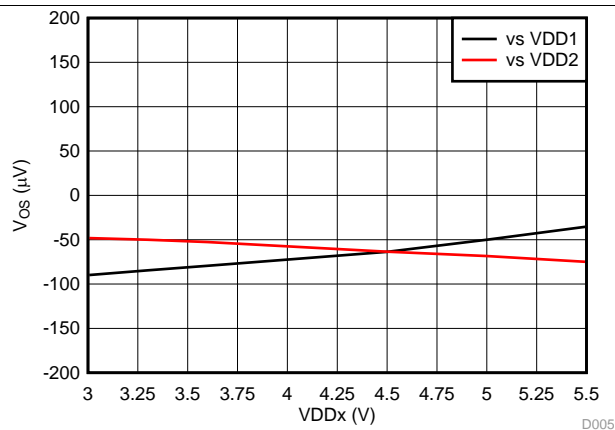

Figure 8. Input Offset Voltage vs Supply Voltage

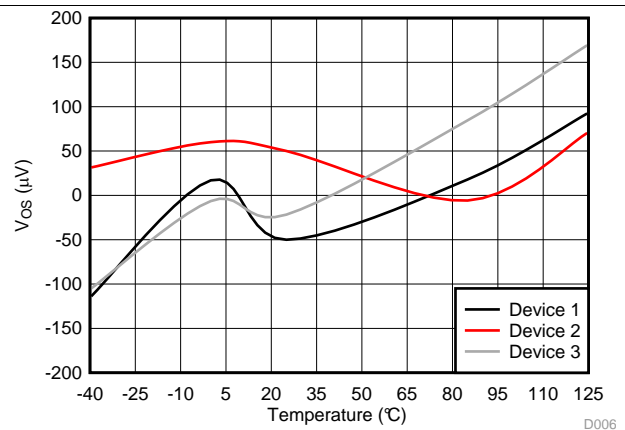
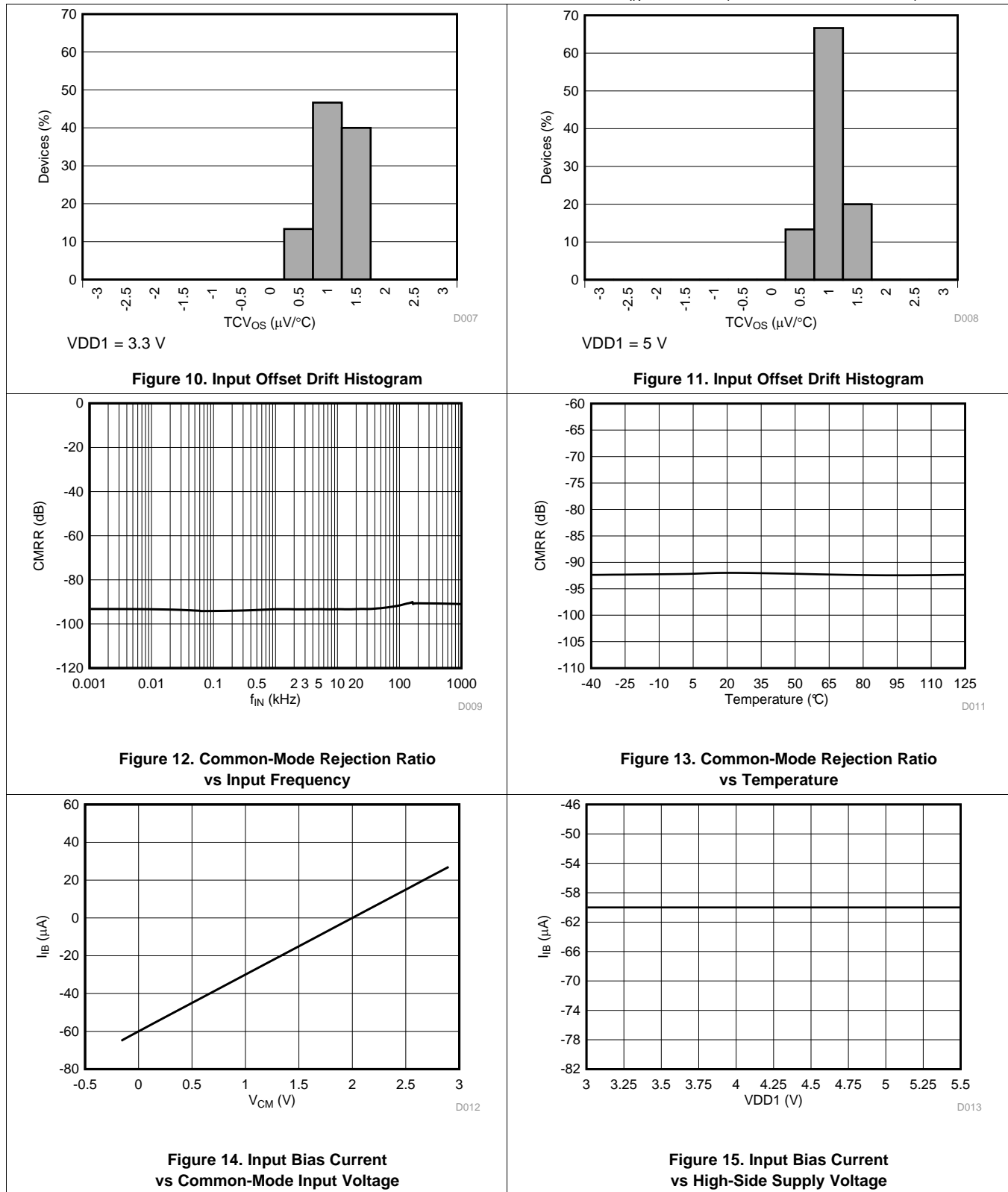

Figure 9. Input Offset Voltage vs Temperature

Typical Characteristics (continued)

at VDD1 = 5 V, VDD2 = 3.3 V, VINP = -250 mV to 250 mV, VINN = 0 V, and f_{IN} = 10 kHz (unless otherwise noted)



Typical Characteristics (continued)

at VDD1 = 5 V, VDD2 = 3.3 V, VINP = -250 mV to 250 mV, VINN = 0 V, and f_{IN} = 10 kHz (unless otherwise noted)

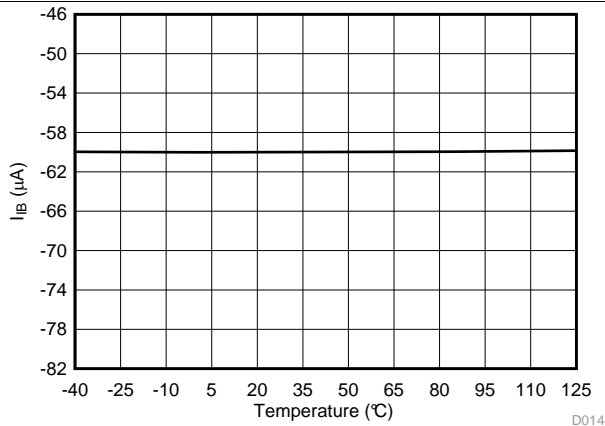

Figure 16. Input Bias Current vs Temperature

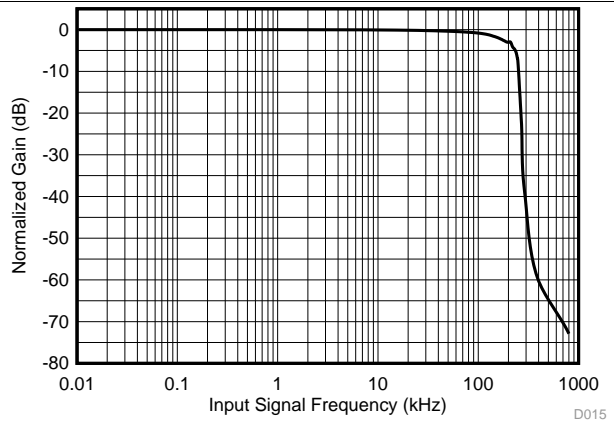

Figure 17. Normalized Gain vs Input Frequency

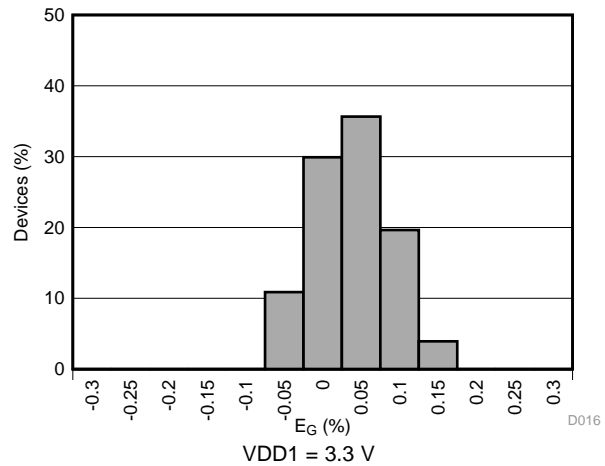

Figure 18. Gain Error Histogram

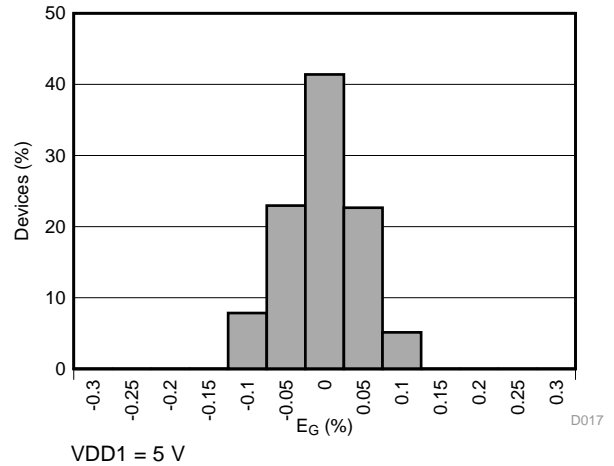

Figure 19. Gain Error Histogram

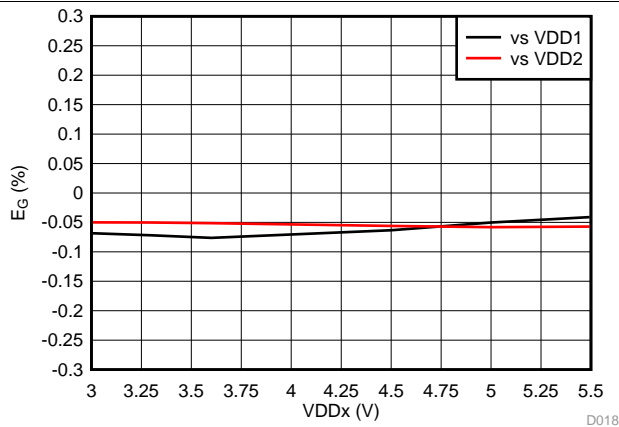

Figure 20. Gain Error vs Supply Voltage

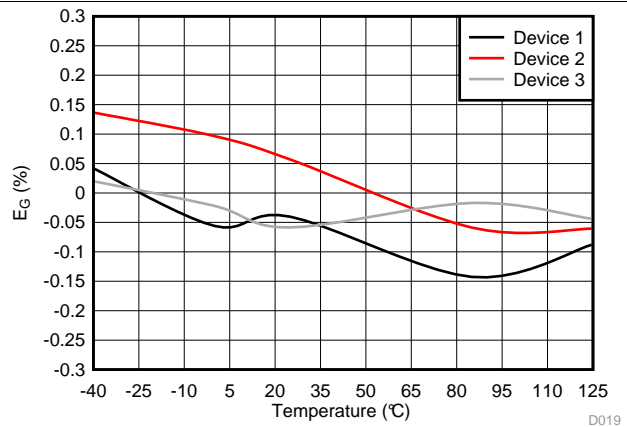
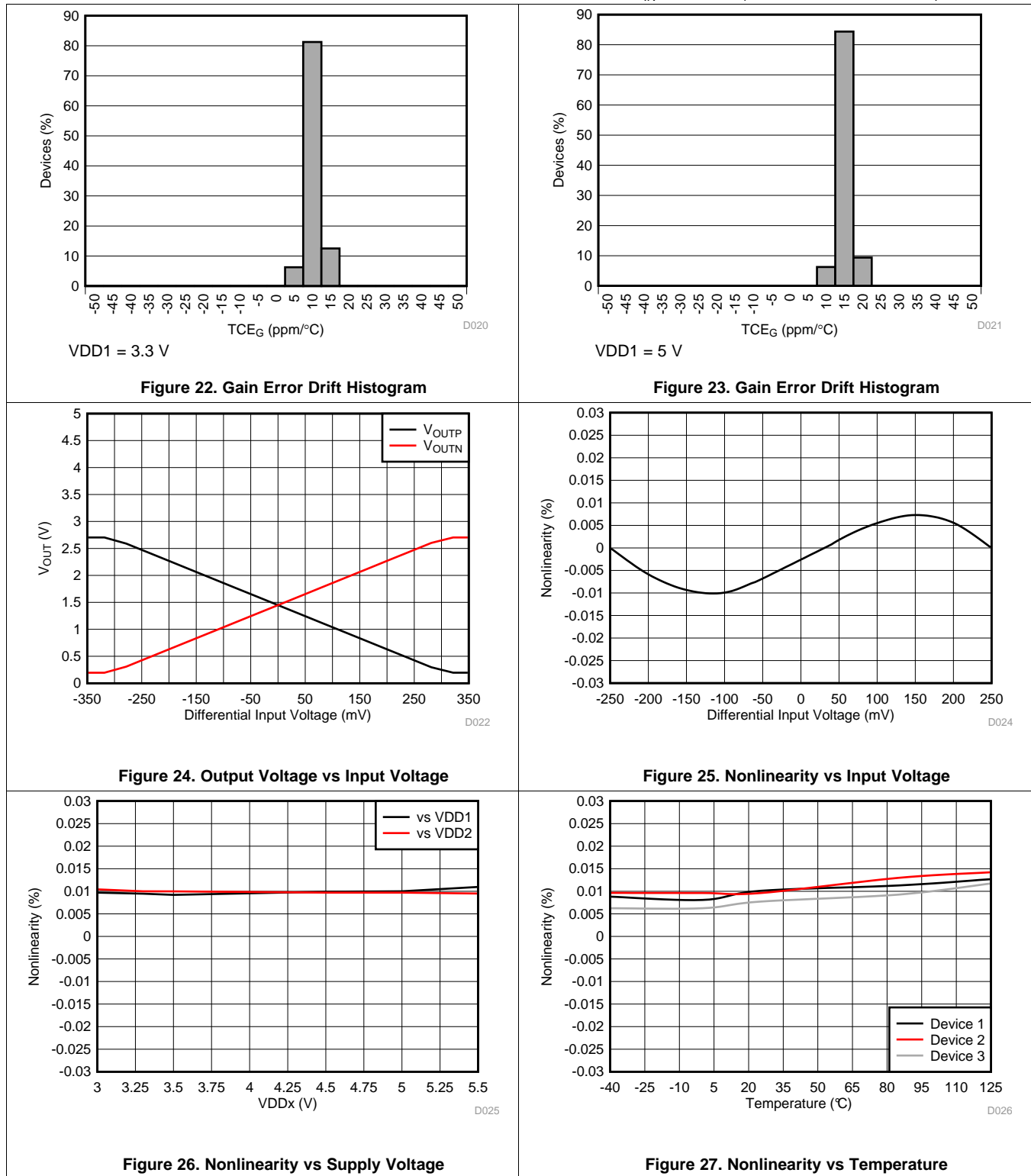

Figure 21. Gain Error vs Temperature

Typical Characteristics (continued)

at VDD1 = 5 V, VDD2 = 3.3 V, VINP = -250 mV to 250 mV, VINN = 0 V, and f_{IN} = 10 kHz (unless otherwise noted)



Typical Characteristics (continued)

at VDD1 = 5 V, VDD2 = 3.3 V, VINP = -250 mV to 250 mV, VINN = 0 V, and f_{IN} = 10 kHz (unless otherwise noted)

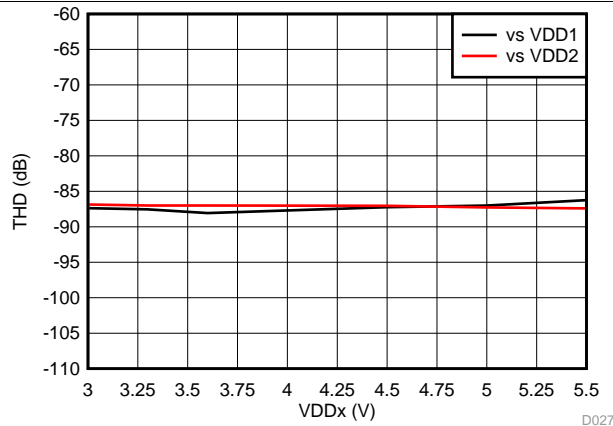

Figure 28. Total Harmonic Distortion vs Supply Voltage

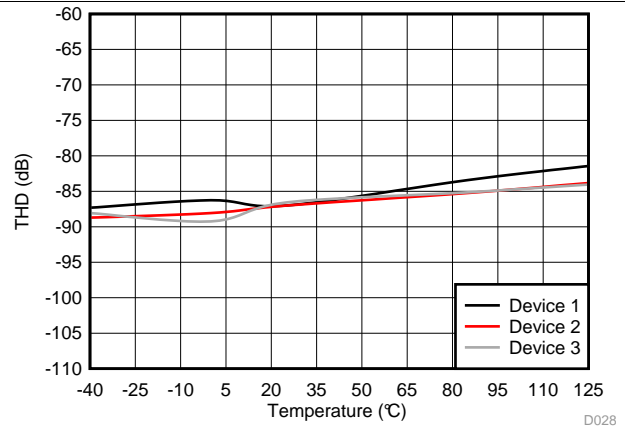

Figure 29. Total Harmonic Distortion vs Temperature

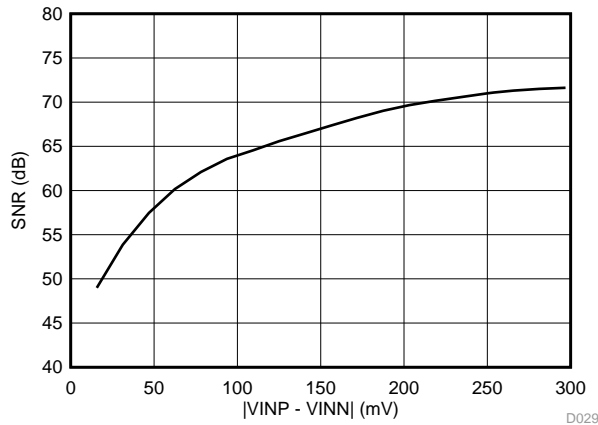

Figure 30. Signal-to-Noise Ratio vs Input Voltage

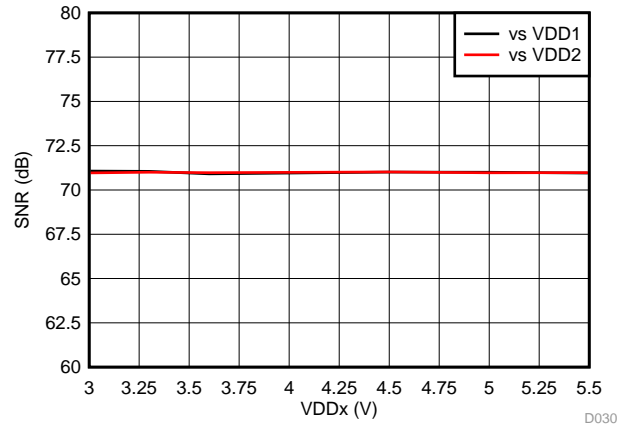

Figure 31. Signal-to-Noise Ratio vs Supply Voltage

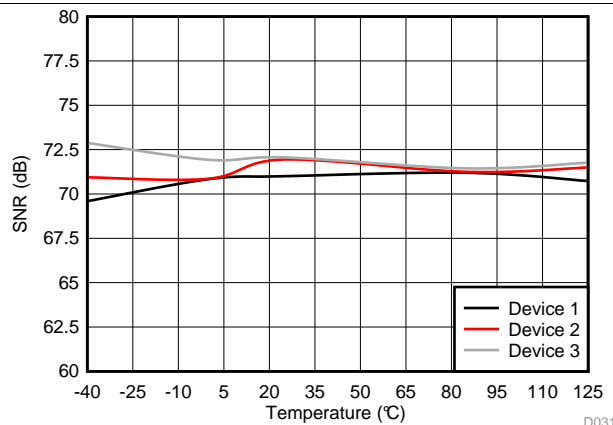

Figure 32. Signal-to-Noise Ratio vs Temperature

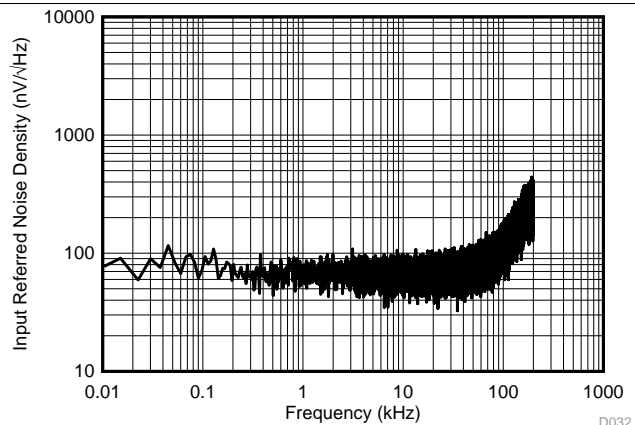
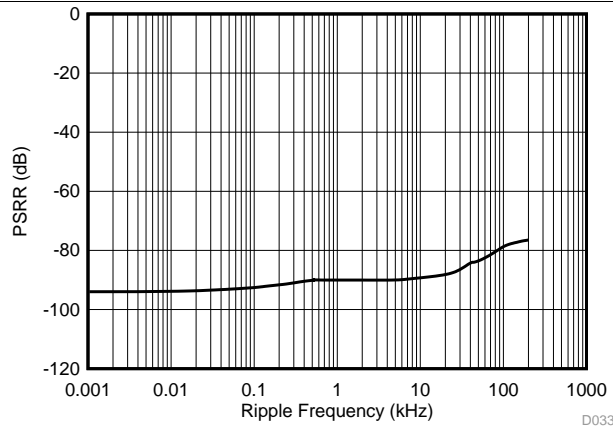

Figure 33. Input-Referred Noise Density vs Frequency

Typical Characteristics (continued)

at VDD1 = 5 V, VDD2 = 3.3 V, VINP = -250 mV to 250 mV, VINN = 0 V, and f_{IN} = 10 kHz (unless otherwise noted)



vs VDD1

Figure 34. Power-Supply Rejection Ratio vs Ripple Frequency

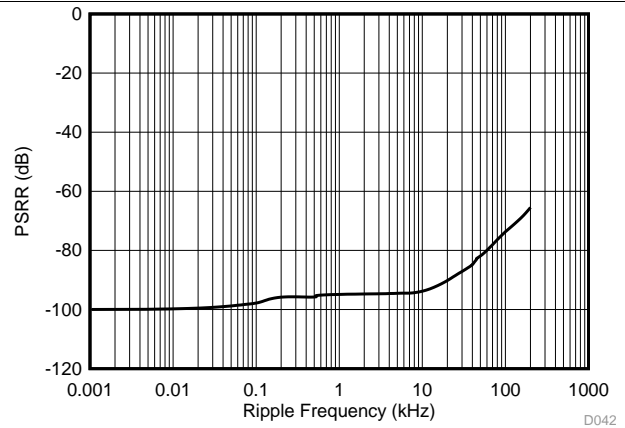

vs VDD2

Figure 35. Power-Supply Rejection Ratio vs Ripple Frequency

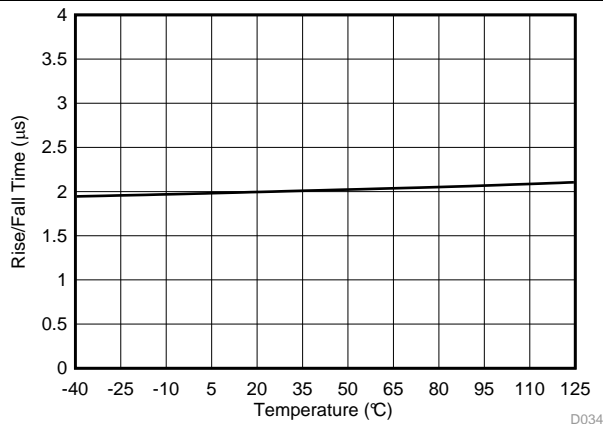

Figure 36. Output Rise and Fall Time vs Temperature

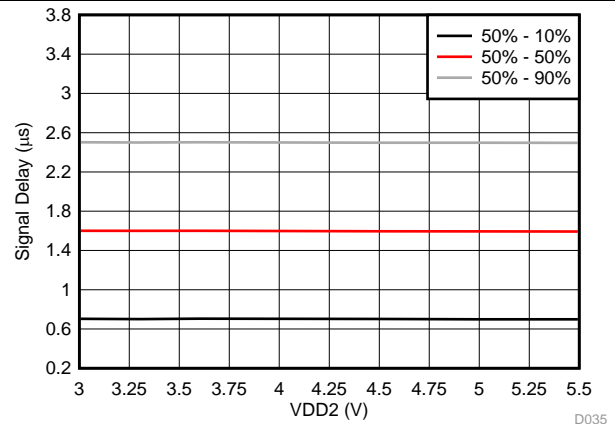

Figure 37. V_{IN} to V_{OUT} Signal Delay vs Low-Side Supply Voltage

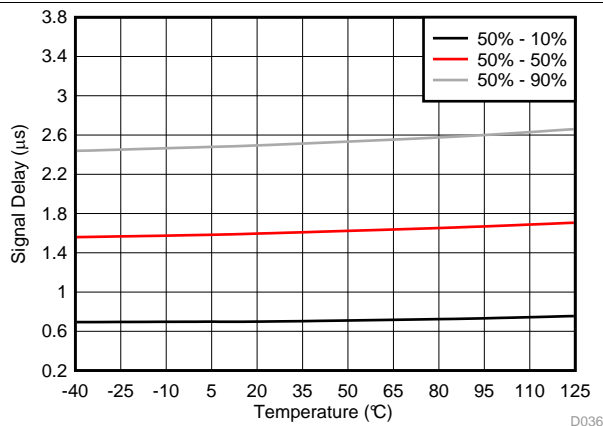

Figure 38. V_{IN} to V_{OUT} Signal Delay vs Temperature

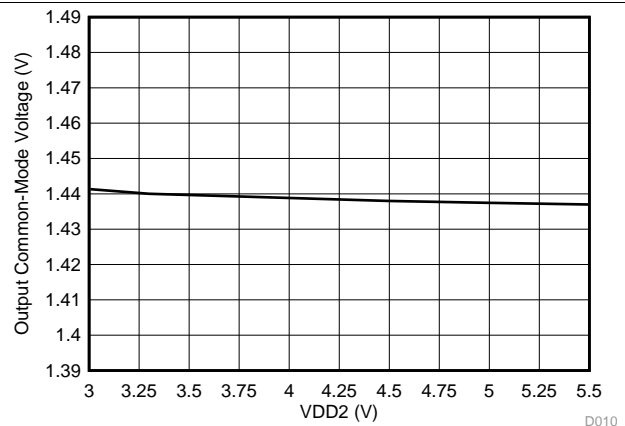

Figure 39. Output Common-Mode Voltage vs Low-Side Supply Voltage

Typical Characteristics (continued)

at VDD1 = 5 V, VDD2 = 3.3 V, VINP = -250 mV to 250 mV, VINN = 0 V, and f_{IN} = 10 kHz (unless otherwise noted)

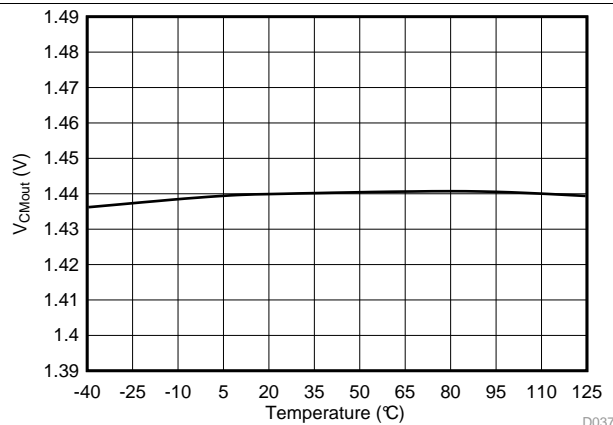

Figure 40. Output Common-Mode Voltage vs Temperature

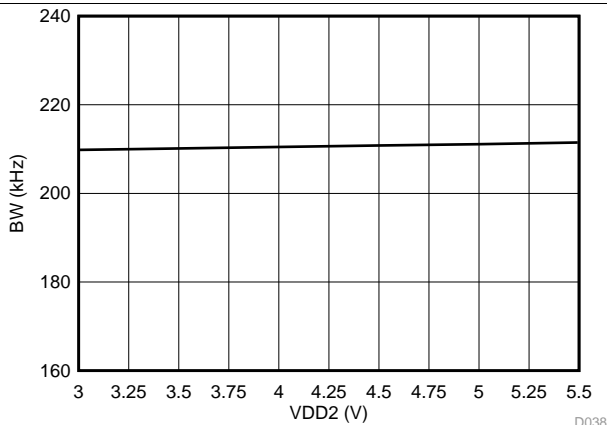

Figure 41. Output Bandwidth vs Low-Side Supply Voltage

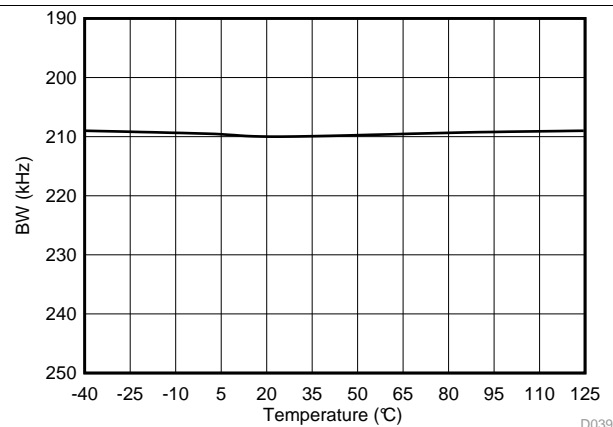

Figure 42. Output Bandwidth vs Temperature

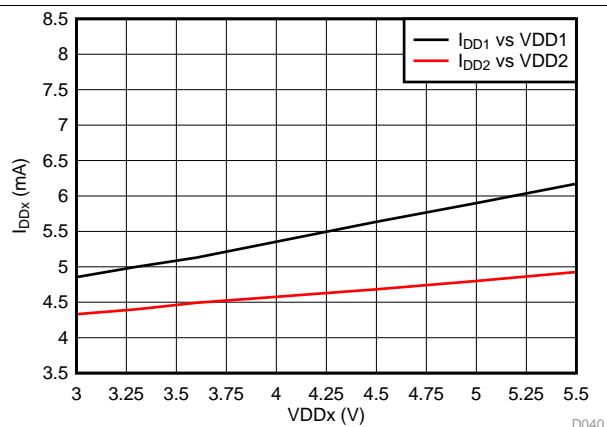

Figure 43. Supply Current vs Supply Voltage

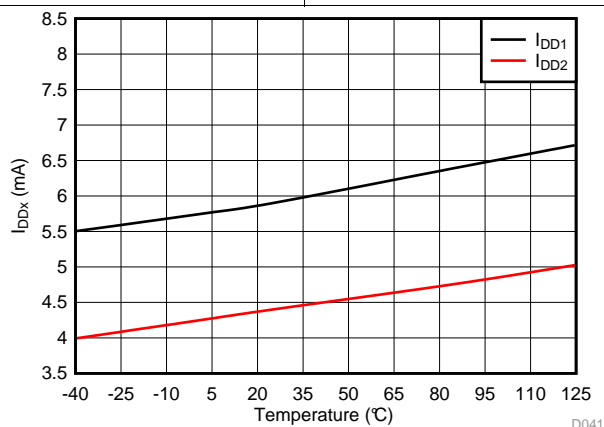

Figure 44. Supply Current vs Temperature

7 Parameter Measurement Information

7.1 Timing Diagrams

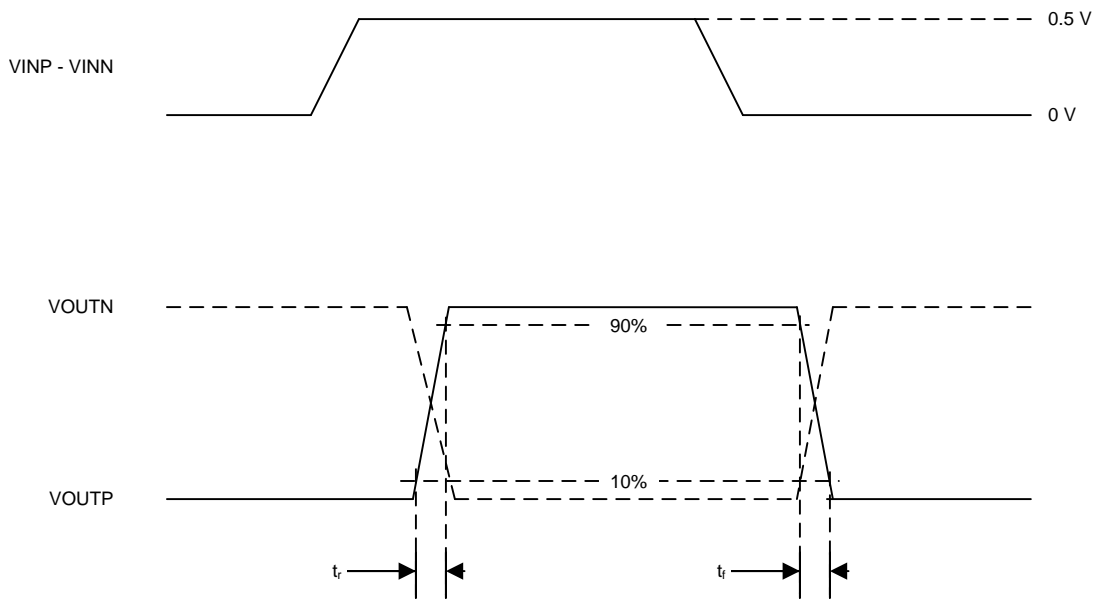

Figure 45. Rise and Fall Time Test Waveforms

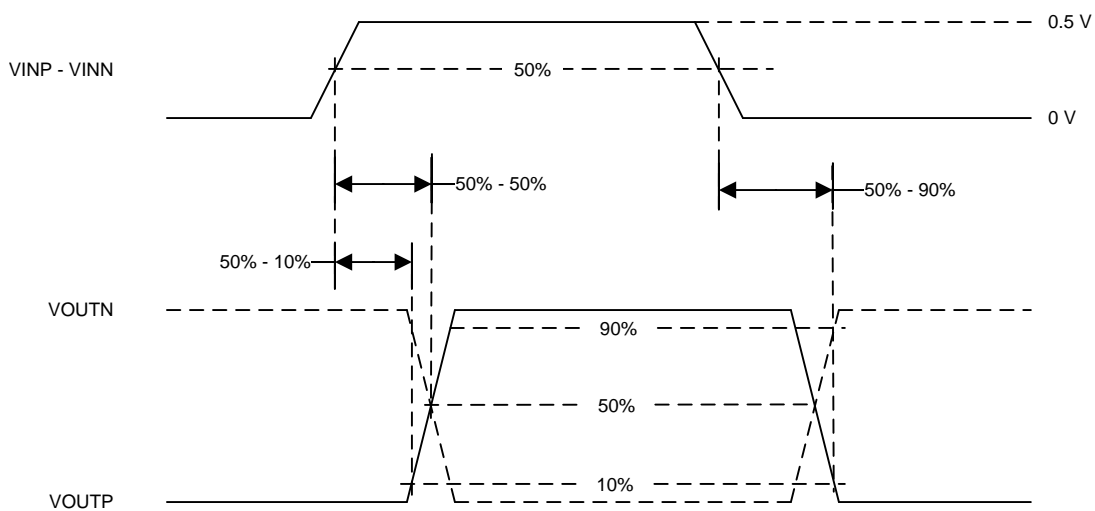

Figure 46. Delay Time Test Waveforms

8 Detailed Description

8.1 Overview

The AMC1301-Q1 device is a fully-differential, precision, isolated amplifier. The input stage of the device consists of a fully-differential amplifier that drives a second-order, delta-sigma ($\Delta\Sigma$) modulator. The modulator uses the internal voltage reference and clock generator to convert the analog input signal to a digital bitstream. The drivers (called TX in the [Functional Block Diagram](#)) transfer the output of the modulator across the isolation barrier that separates the high-side and low-side voltage domains. The received bitstream and clock are synchronized and processed by a fourth-order analog filter on the low-side and presented as a differential output of the device, as shown in the [Functional Block Diagram](#).

The SiO₂-based, double-capacitive isolation barrier supports a high level of magnetic field immunity, as described in [ISO72x Digital Isolator Magnetic-Field Immunity](#). The digital modulation used in the AMC1301-Q1 device and the isolation barrier characteristics result in high reliability and common-mode transient immunity.

8.2 Functional Block Diagram

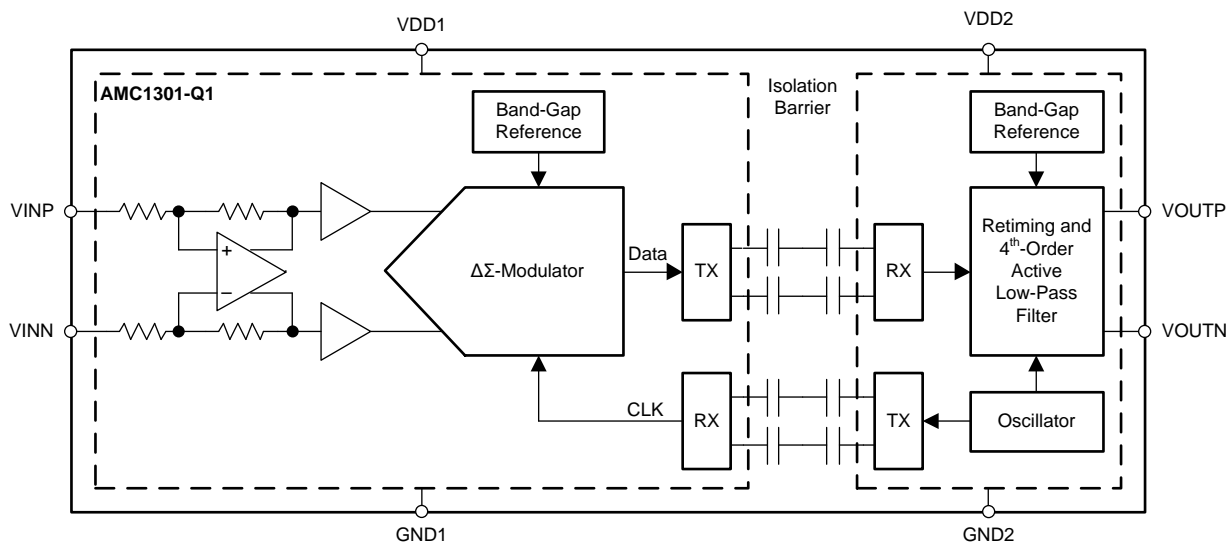

Copyright © 2016, Texas Instruments Incorporated

8.3 Feature Description

8.3.1 Analog Input

The AMC1301-Q1 device incorporates front-end circuitry that contains a fully-differential amplifier followed by a $\Delta\Sigma$ modulator sampling stage. The gain of the differential amplifier is set by internal precision resistors to a factor of 4 with a differential input impedance of 22 k Ω . Consider the input impedance of the AMC1301-Q1 device in designs with high-impedance signal sources that may cause degradation of gain and offset specifications. The importance of this effect, however, depends on the desired system performance.

Additionally, the input bias current caused by the internal common-mode voltage at the output of the differential amplifier causes an offset that is dependent on the actual amplitude of the input signal. See the [Isolated Voltage Sensing](#) section for more details on reducing this effect.

There are two restrictions on the analog input signals (VINP and VINN). First, if the input voltage exceeds the range GND1 – 6 V to VDD1 + 0.5 V, then the input current must be limited to 10 mA because the device input electrostatic discharge (ESD) protection turns on. In addition, the linearity and noise performance of the device are ensured only when the analog input voltage remains within the specified linear full-scale range (FSR) and within the specified common-mode input voltage range.

Feature Description (continued)

8.3.2 Fail-Safe Output

The AMC1301-Q1 device offers a fail-safe output that simplifies diagnostics on system level. The fail-safe output is active in two cases:

- When the high-side supply VDD1 of the AMC1301-Q1 device is missing, or
- When the common-mode input voltage, that is $V_{CM} = (VINP + VINN) / 2$, exceeds the minimum common-mode over-voltage detection level V_{CMov} of $VDD1 - 2\text{ V}$.

The fail-safe output of the AMC1301-Q1 device is a negative differential output voltage value that differs from the negative clipping output voltage, as shown in [Figure 47](#) and [Figure 48](#). As a reference value for the fail-safe detection on a system level, use the $V_{FAILSAFE}$ maximum value of -2.545 V .



Figure 47. Typical Negative Clipping Output of the AMC1301-Q1 Device

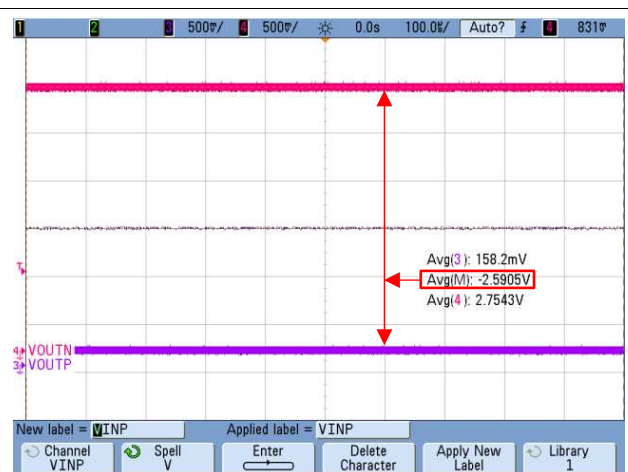

Figure 48. Typical Failsafe Output of the AMC1301-Q1 Device

8.4 Device Functional Modes

The AMC1301-Q1 device is operational when the power supplies VDD1 and VDD2 are applied, as specified in [Recommended Operating Conditions](#).

9 Application and Implementation

NOTE

Information in the following applications sections is not part of the TI component specification, and TI does not warrant its accuracy or completeness. TI's customers are responsible for determining suitability of components for their purposes. Customers should validate and test their design implementation to confirm system functionality.

9.1 Application Information

The AMC1301-Q1 device offers unique linearity, high input common-mode and power-supply rejection, low ac and dc errors, and low temperature drift. These features make the AMC1301-Q1 device a robust, high-performance, isolated amplifier for automotive applications where high voltage isolation is required.

9.2 Typical Applications

9.2.1 Traction Inverter Application

Figure 49 shows a typical operation of the AMC1301-Q1 device for current sensing in a traction inverter application. Phase current measurement is done through the shunt resistor, R_{SHUNT} (in this case, a two-pin shunt). The differential input and the high common-mode transient immunity of the AMC1301-Q1 device ensure reliable and accurate operation even in high-noise environments (such as the power stage of the traction inverter).

Additionally, the AMC1301-Q1 device may also be used for isolated voltage measurement of the dc-link, as described in [Isolated Voltage Sensing](#).

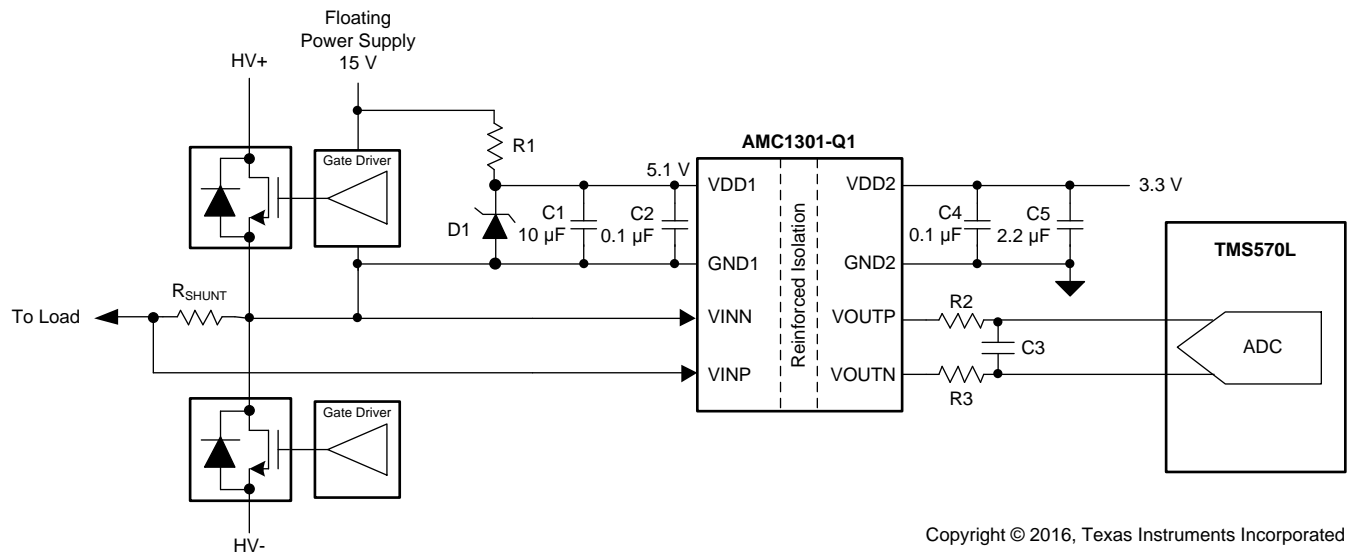

Copyright © 2016, Texas Instruments Incorporated

Figure 49. Using the AMC1301-Q1 Device for Current Sensing in Traction Inverters

Typical Applications (continued)

9.2.1.1 Design Requirements

Table 1 lists the parameters for the typical application in Figure 49.

Table 1. Design Requirements

PARAMETER	VALUE
High-side supply voltage	3.3 V or 5 V
Low-side supply voltage	3.3 V or 5 V
Voltage drop across the shunt for a linear response	± 250 mV (maximum)

9.2.1.2 Detailed Design Procedure

The high-side power supply (VDD1) for the AMC1301-Q1 device is derived from the power supply of the upper gate driver. Further details are provided in the [Power Supply Recommendations](#) section.

The floating ground reference (GND1) is derived from one of the ends of the shunt resistor that is connected to the negative input of the AMC1301-Q1 device (VINN). If a four-pin shunt is used, the inputs of the AMC1301-Q1 device are connected to the inner leads and GND1 is connected to one of the outer shunt leads.

Use Ohm's Law to calculate the voltage drop across the shunt resistor (V_{SHUNT}) for the desired measured current: $V_{SHUNT} = I \times R_{SHUNT}$.

Consider the following two restrictions to choose the proper value of the shunt resistor R_{SHUNT} :

- The voltage drop caused by the nominal current range must not exceed the recommended differential input voltage range: $V_{SHUNT} \leq \pm 250$ mV
- The voltage drop caused by the maximum allowed overcurrent must not exceed the input voltage that causes a clipping output: $V_{SHUNT} \leq V_{Clipping}$

For best performance, use an RC filter (components R_2 , R_3 , and C_3 in Figure 49) to minimize the noise of the differential output signal. Tailor the bandwidth of this RC filter to the bandwidth requirement of the system. TI recommends an NP0-type capacitor to be used for C_3 .

For more information on the general procedure to design the filtering and driving stages of SAR ADCs, consult the TI Precision Designs [18-Bit, 1MSPS Data Acquisition Block \(DAQ\) Optimized for Lowest Distortion and Noise](#) (SLAU515) and [18-Bit Data Acquisition Block \(DAQ\) Optimized for Lowest Power](#) (SLAU513), available for download at www.ti.com.

9.2.1.3 Application Curves

In traction inverter applications, the power switches must be protected in case of an overcurrent condition. To allow for fast powering off of the system, a low delay caused by the isolated amplifier is required. Figure 50 shows the typical full-scale step response of the AMC1301-Q1 device. Consider the delay of the required window comparator and the MCU to calculate the overall response time of the system.



Figure 50. Step Response of the AMC1301-Q1 Device

The high linearity and low temperature drift of offset and gain errors of the AMC1301-Q1 device, as shown in Figure 51, allows design of motor drives with low torque ripple.

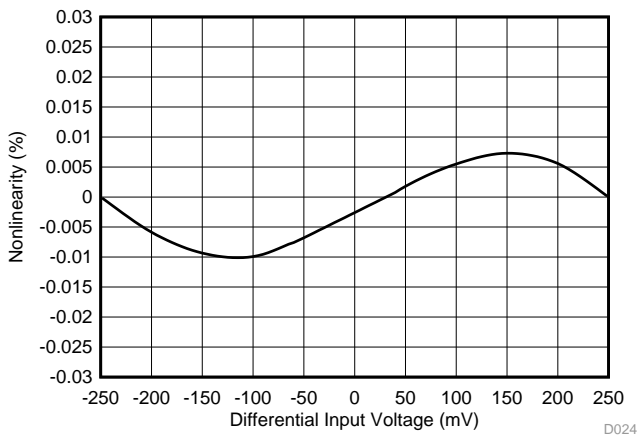
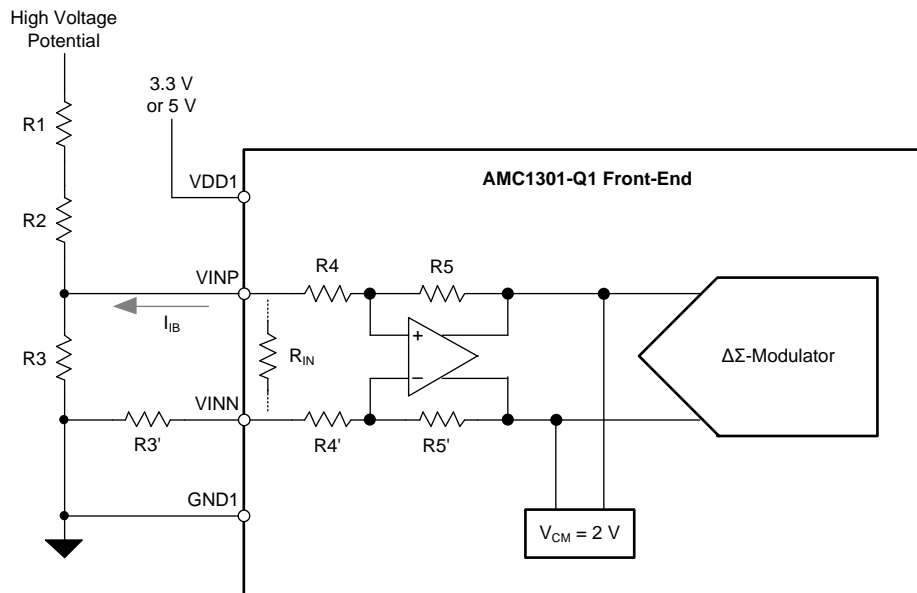

Figure 51. Typical Nonlinearity of the AMC1301-Q1 Device

9.2.2 Isolated Voltage Sensing

The AMC1301-Q1 device is optimized for usage in current-sensing applications using low-impedance shunts. However, the device may also be used in isolated voltage-sensing applications if the effect of the (usually higher) impedance of the resistor divider used in this case is considered.



Copyright © 2016, Texas Instruments Incorporated

Figure 52. Using the AMC1301-Q1 Device for Isolated Voltage Sensing

9.2.2.1 Design Requirements

Figure 52 shows a simplified circuit typically used in high-voltage sensing applications. The high-impedance resistors (R1 and R2) dominate the current value that flows through the resistive divider. The resistance of the sensing resistor R3 is chosen to meet the input voltage range of the AMC1301-Q1 device. This resistor and the input impedance of the device ($R_{IN} = 18\text{ k}\Omega$) also create a voltage divider that results in an additional gain error. With the assumption of R1 and R2 having a considerably higher value than R3 and omitting R3' for the moment, the resulting total gain error is estimated using Equation 1, with E_G being the initial gain error of the AMC1301-Q1 device.

$$|E_{G_{tot}}| = |E_G| + \frac{R_3}{R_{IN}} \quad (1)$$

This gain error may be easily minimized during the initial system-level gain calibration procedure.

9.2.2.2 Detailed Design Procedure

As indicated in Figure 52, the output of the integrated differential amplifier is internally biased to a common-mode voltage of 2 V. This voltage results in a bias current I_{IB} through the resistive network R4 and R5 (or R4' and R5') used for setting the gain of the amplifier. The value of this current is specified in the [Pin Configuration and Functions](#) section. This bias current generates additional offset and gain errors that depend on the value of the resistor R3. Because the value of this bias current depends on the actual common-mode amplitude of the input signal (as shown in Figure 53), the initial system offset calibration eliminates the offset but not the gain error component. Therefore, in systems with high accuracy requirements, a series resistor is recommended to be used at the negative input (VINN) of the AMC1301-Q1 device with a value equal to the shunt resistor R3 (that is, $R3' = R3$ in Figure 52) to eliminate the effect of the bias current.

This additional series resistor (R3') influences the gain error of the circuit. The effect is calculated using Equation 2 with $R4 = R4' = 12.5\text{ k}\Omega$. The effect of the internal resistors $R5 = R5'$ cancels in this calculation.

$$E_G(\%) = \left(1 - \frac{R4}{R4' + R3'} \right) * 100\% \quad (2)$$

9.2.2.3 Application Curve

Figure 53 shows the dependency of the input bias current on the common-mode voltage at the input of the AMC1301-Q1 device.

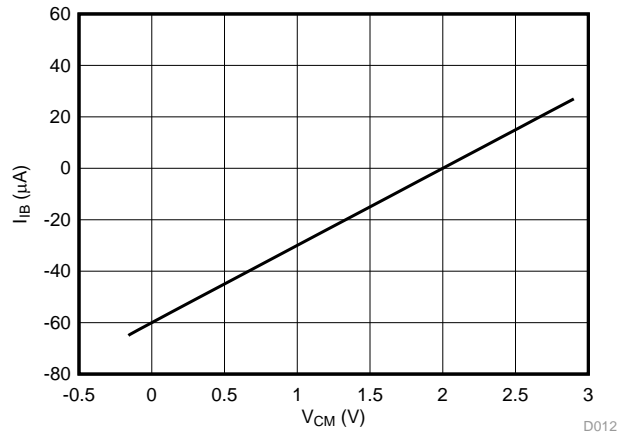

Figure 53. Input Current vs Input Common-Mode Voltage

9.3 Do's and Don'ts

Do not leave the inputs of the AMC1301-Q1 device unconnected (floating) when the device is powered up. If both device inputs are left floating, the input bias current drives them to the output common-mode of the analog front-end of approximately 2 V. If the high-side supply voltage VDD1 is below 4 V, the internal common-mode overvoltage detector turns on and the output functions as described in the *Fail-Safe Output* section, which may lead to an undesired reaction on the system level.

10 Power Supply Recommendations

In a typical traction inverter application, the high-side power supply (VDD1) for the device is derived from the floating power supply of the upper gate driver. For lowest cost, a Zener diode may be used to limit the voltage to 5 V (or 3.3 V, depending on the design) $\pm 10\%$. Alternatively a low-cost, low-dropout (LDO) regulator (for example, the [LP2951-XX-Q1](#)) may be used to minimize noise on the power supply. TI recommends a low-ESR decoupling capacitor of 0.1 μF to filter this power-supply path. Place this capacitor (C_2 in [Figure 54](#)) as close as possible to the VDD1 pin of the AMC1301-Q1 device for best performance. If better filtering is required, an additional 10- μF capacitor may be used. The floating ground reference (GND1) is derived from the end of the shunt resistor, which is connected to the negative input (VINN) of the device. If a four-pin shunt is used, the device inputs are connected to the inner leads, and GND1 is connected to one of the outer leads of the shunt.

To decouple the digital power supply on the controller side, use a 0.1- μF capacitor placed as close to the VDD2 pin of the AMC1301-Q1 device as possible, followed by an additional capacitor from 1 μF to 10 μF .

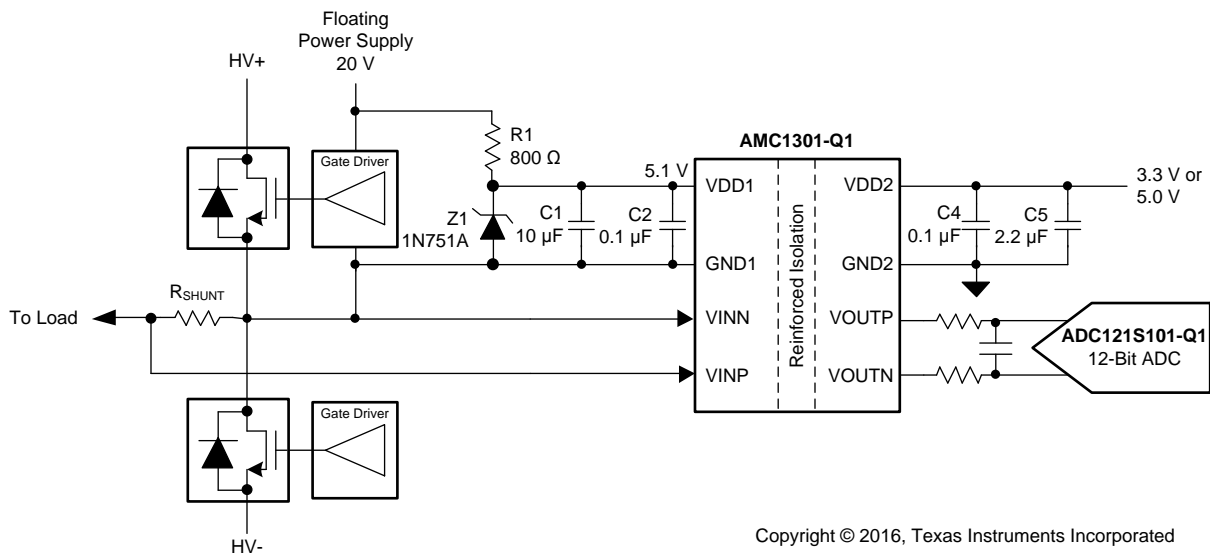

Figure 54. Zener-Diode-Based, High-Side Power Supply

11 Layout

11.1 Layout Guidelines

A layout recommendation showing the critical placement of the decoupling capacitors (as close as possible to the AMC1301-Q1 device) and placement of the other components required by the device is shown in Figure 55. For best performance, place the shunt resistor close to the VINP and VINN inputs of the AMC1301-Q1 device and keep the layout of both connections symmetrical.

11.2 Layout Example

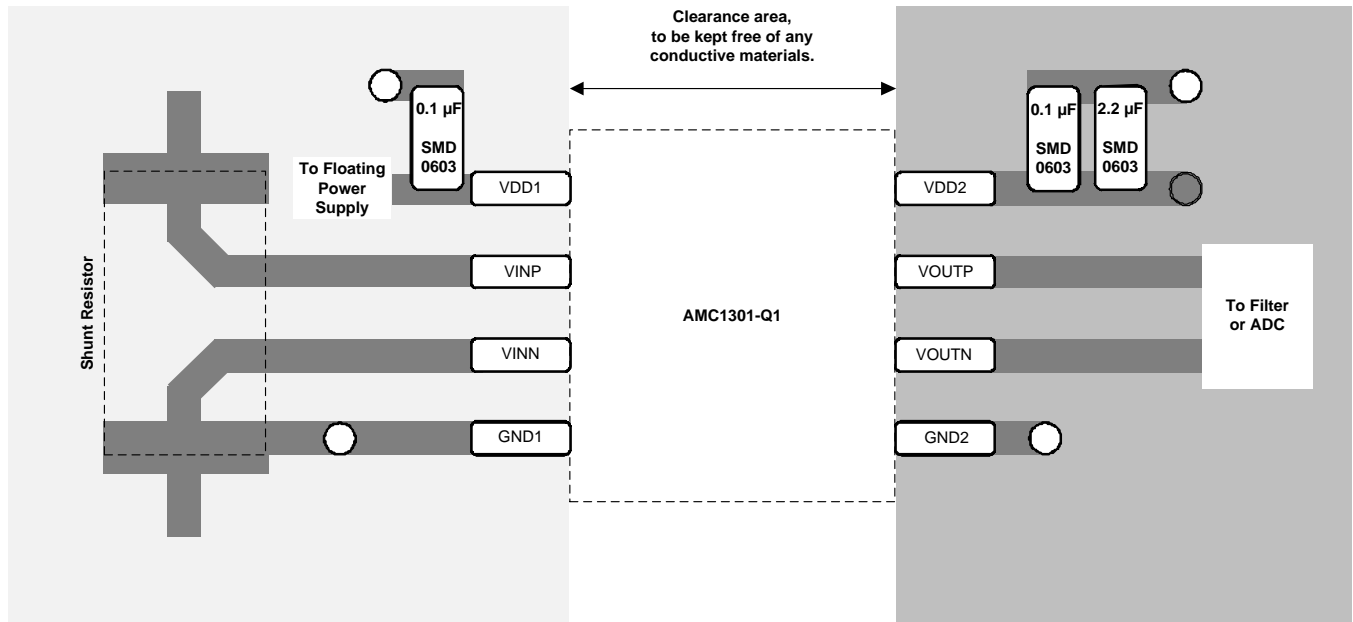

LEGEND

- Copper Pour and Traces
- High-Side Area
- Low-Side Area
- Via to Ground Plane
- Via to Supply Plane

Copyright © 2016, Texas Instruments Incorporated

Figure 55. Recommended Layout of the AMC1301-Q1 Device

12 Device and Documentation Support

12.1 Documentation Support

12.1.1 Related Documentation

For related documentation, see the following:

- [Isolation Glossary](#)
- [ADC121S101-Q1 Single-Channel, 0.5 to 1-Msps, 12-Bit Analog-to-Digital Converter](#)
- [LP2951-xx-Q1 Adjustable Micropower Voltage Regulators With Shutdown](#)
- [TMS570LS0232 16- and 32-Bit RISC Flash Microcontroller](#)
- [ISO72x Digital Isolator Magnetic-Field Immunity](#)
- [18-Bit, 1-MSPS Data Acquisition Block \(DAQ\) Optimized for Lowest Distortion and Noise](#)
- [18-Bit, 1-MSPS Data Acquisition Block \(DAQ\) Optimized for Lowest Power](#)

12.2 Receiving Notification of Documentation Updates

To receive notification of documentation updates, navigate to the device product folder on ti.com. In the upper right corner, click on *Alert me* to register and receive a weekly digest of any product information that has changed. For change details, review the revision history included in any revised document.

12.3 Community Resources

The following links connect to TI community resources. Linked contents are provided "AS IS" by the respective contributors. They do not constitute TI specifications and do not necessarily reflect TI's views; see TI's [Terms of Use](#).

TI E2E™ Online Community *TI's Engineer-to-Engineer (E2E) Community*. Created to foster collaboration among engineers. At e2e.ti.com, you can ask questions, share knowledge, explore ideas and help solve problems with fellow engineers.

Design Support *TI's Design Support* Quickly find helpful E2E forums along with design support tools and contact information for technical support.

12.4 Trademarks

E2E is a trademark of Texas Instruments.
All other trademarks are the property of their respective owners.

12.5 Electrostatic Discharge Caution



This integrated circuit can be damaged by ESD. Texas Instruments recommends that all integrated circuits be handled with appropriate precautions. Failure to observe proper handling and installation procedures can cause damage.

ESD damage can range from subtle performance degradation to complete device failure. Precision integrated circuits may be more susceptible to damage because very small parametric changes could cause the device not to meet its published specifications.

12.6 Glossary

[SLYZ022](#) — *TI Glossary*.

This glossary lists and explains terms, acronyms, and definitions.

13 Mechanical, Packaging, And Orderable Information

The following pages include mechanical, packaging, and orderable information. This information is the most current data available for the designated devices. This data is subject to change without notice and revision of this document. For browser-based versions of this data sheet, refer to the left-hand navigation.

PACKAGING INFORMATION

Orderable Device	Status (1)	Package Type	Package Drawing	Pins	Package Qty	Eco Plan (2)	Lead/Ball Finish (6)	MSL Peak Temp (3)	Op Temp (°C)	Device Marking (4/5)	Samples
AMC1301QDWVQ1	PREVIEW	SOIC	DWV	8	64	Green (RoHS & no Sb/Br)	CU NIPDAU	Level-3-260C-168 HR	-40 to 125	1301Q1	
AMC1301QDWVRQ1	PREVIEW	SOIC	DWV	8	1000	Green (RoHS & no Sb/Br)	CU NIPDAU	Level-3-260C-168 HR	-40 to 125	1301Q1	

(1) The marketing status values are defined as follows:

ACTIVE: Product device recommended for new designs.

LIFEBUY: TI has announced that the device will be discontinued, and a lifetime-buy period is in effect.

NRND: Not recommended for new designs. Device is in production to support existing customers, but TI does not recommend using this part in a new design.

PREVIEW: Device has been announced but is not in production. Samples may or may not be available.

OBsolete: TI has discontinued the production of the device.

(2) Eco Plan - The planned eco-friendly classification: Pb-Free (RoHS), Pb-Free (RoHS Exempt), or Green (RoHS & no Sb/Br) - please check <http://www.ti.com/productcontent> for the latest availability information and additional product content details.

TBD: The Pb-Free/Green conversion plan has not been defined.

Pb-Free (RoHS): TI's terms "Lead-Free" or "Pb-Free" mean semiconductor products that are compatible with the current RoHS requirements for all 6 substances, including the requirement that lead not exceed 0.1% by weight in homogeneous materials. Where designed to be soldered at high temperatures, TI Pb-Free products are suitable for use in specified lead-free processes.

Pb-Free (RoHS Exempt): This component has a RoHS exemption for either 1) lead-based flip-chip solder bumps used between the die and package, or 2) lead-based die adhesive used between the die and leadframe. The component is otherwise considered Pb-Free (RoHS compatible) as defined above.

Green (RoHS & no Sb/Br): TI defines "Green" to mean Pb-Free (RoHS compatible), and free of Bromine (Br) and Antimony (Sb) based flame retardants (Br or Sb do not exceed 0.1% by weight in homogeneous material)

(3) MSL, Peak Temp. - The Moisture Sensitivity Level rating according to the JEDEC industry standard classifications, and peak solder temperature.

(4) There may be additional marking, which relates to the logo, the lot trace code information, or the environmental category on the device.

(5) Multiple Device Markings will be inside parentheses. Only one Device Marking contained in parentheses and separated by a "~" will appear on a device. If a line is indented then it is a continuation of the previous line and the two combined represent the entire Device Marking for that device.

(6) Lead/Ball Finish - Orderable Devices may have multiple material finish options. Finish options are separated by a vertical ruled line. Lead/Ball Finish values may wrap to two lines if the finish value exceeds the maximum column width.

Important Information and Disclaimer: The information provided on this page represents TI's knowledge and belief as of the date that it is provided. TI bases its knowledge and belief on information provided by third parties, and makes no representation or warranty as to the accuracy of such information. Efforts are underway to better integrate information from third parties. TI has taken and continues to take reasonable steps to provide representative and accurate information but may not have conducted destructive testing or chemical analysis on incoming materials and chemicals. TI and TI suppliers consider certain information to be proprietary, and thus CAS numbers and other limited information may not be available for release.

In no event shall TI's liability arising out of such information exceed the total purchase price of the TI part(s) at issue in this document sold by TI to Customer on an annual basis.

OTHER QUALIFIED VERSIONS OF AMC1301-Q1 :

- Catalog: [AMC1301](#)

NOTE: Qualified Version Definitions:

- Catalog - TI's standard catalog product

TAPE AND REEL INFORMATION



QUADRANT ASSIGNMENTS FOR PIN 1 ORIENTATION IN TAPE



*All dimensions are nominal

Device	Package Type	Package Drawing	Pins	SPQ	Reel Diameter (mm)	Reel Width W1 (mm)	A0 (mm)	B0 (mm)	K0 (mm)	P1 (mm)	W (mm)	Pin1 Quadrant
AMC1301QDWVRQ1	SOIC	DWV	8	1000	330.0	16.4	12.05	6.15	3.3	16.0	16.0	Q1

TAPE AND REEL BOX DIMENSIONS



*All dimensions are nominal

Device	Package Type	Package Drawing	Pins	SPQ	Length (mm)	Width (mm)	Height (mm)
AMC1301QDWVRQ1	SOIC	DWV	8	1000	367.0	367.0	38.0

PACKAGE OUTLINE

DWV0008A



SOIC - 2.8 mm max height

SOIC

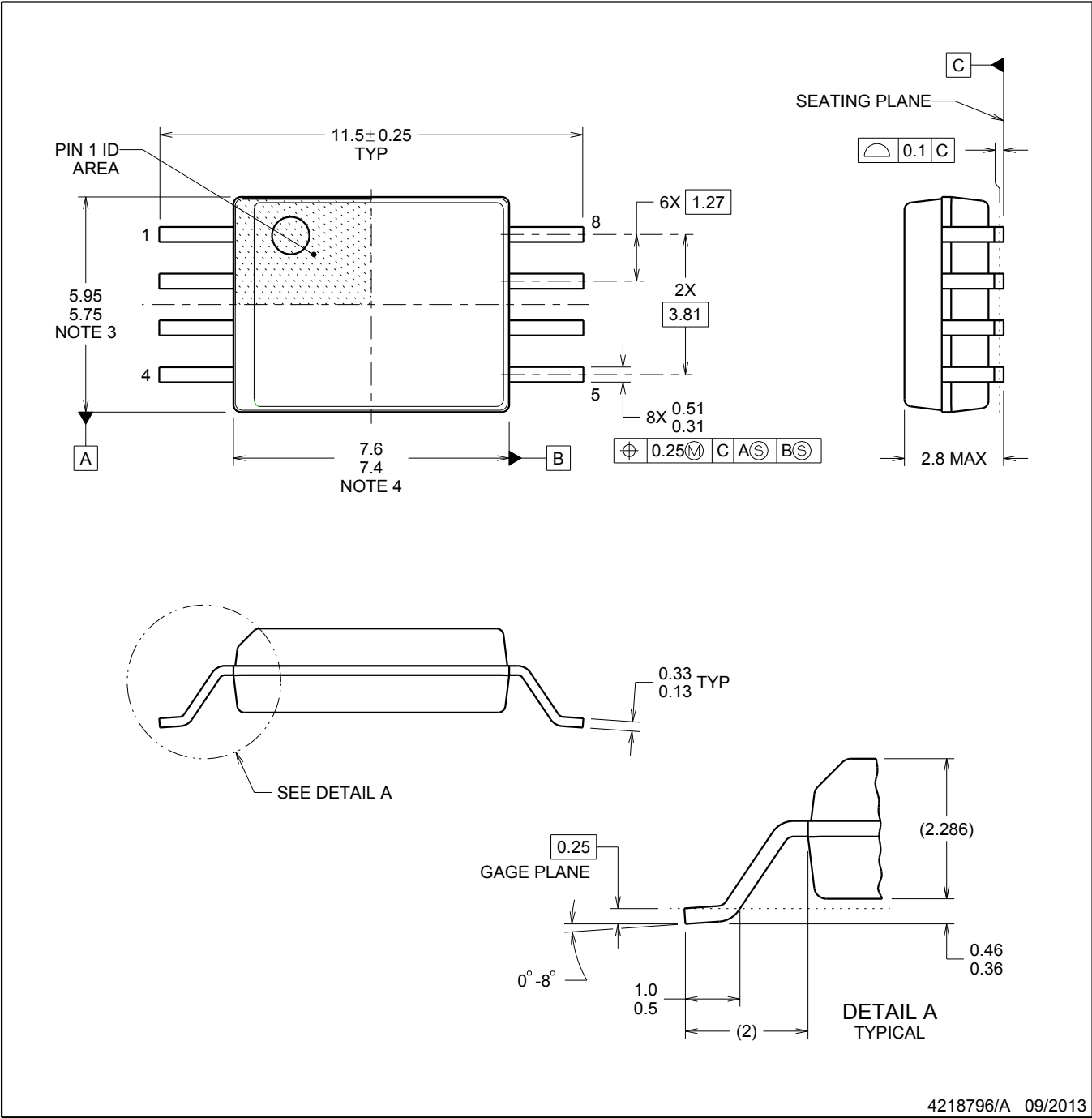

NOTES:

1. All linear dimensions are in millimeters. Dimensions in parenthesis are for reference only. Dimensioning and tolerancing per ASME Y14.5M.
2. This drawing is subject to change without notice.
3. This dimension does not include mold flash, protrusions, or gate burrs. Mold flash, protrusions, or gate burrs shall not exceed 0.15 mm, per side.
4. This dimension does not include interlead flash. Interlead flash shall not exceed 0.25 mm, per side.



LAND PATTERN EXAMPLE
 9.1 mm NOMINAL CLEARANCE/CREEPAGE
 SCALE:6X

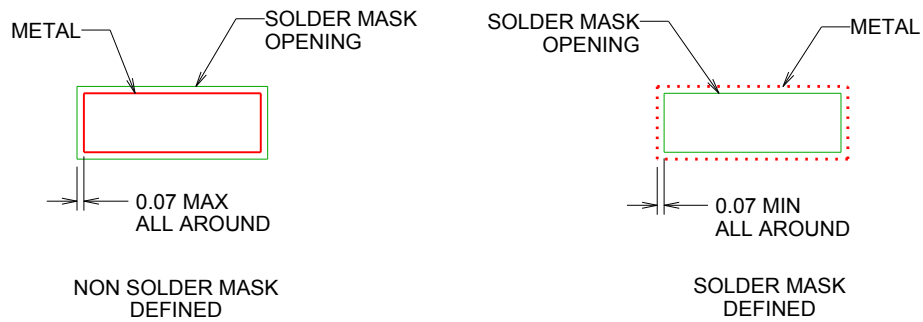

SOLDER MASK DETAILS

4218796/A 09/2013

NOTES: (continued)

- 5. Publication IPC-7351 may have alternate designs.
- 6. Solder mask tolerances between and around signal pads can vary based on board fabrication site.

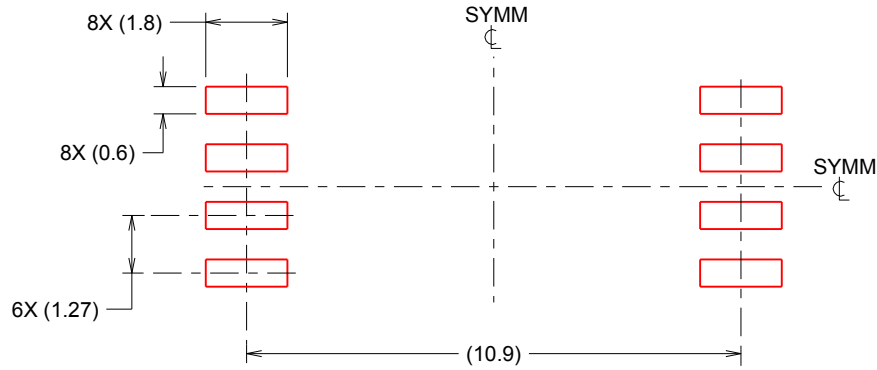

SOLDER PASTE EXAMPLE
 BASED ON 0.125 mm THICK STENCIL
 SCALE:6X

4218796/A 09/2013

NOTES: (continued)

- 7. Laser cutting apertures with trapezoidal walls and rounded corners may offer better paste release. IPC-7525 may have alternate design recommendations.
- 8. Board assembly site may have different recommendations for stencil design.

IMPORTANT NOTICE

Texas Instruments Incorporated (TI) reserves the right to make corrections, enhancements, improvements and other changes to its semiconductor products and services per JESD46, latest issue, and to discontinue any product or service per JESD48, latest issue. Buyers should obtain the latest relevant information before placing orders and should verify that such information is current and complete.

TI's published terms of sale for semiconductor products (<http://www.ti.com/sc/docs/stdterms.htm>) apply to the sale of packaged integrated circuit products that TI has qualified and released to market. Additional terms may apply to the use or sale of other types of TI products and services.

Reproduction of significant portions of TI information in TI data sheets is permissible only if reproduction is without alteration and is accompanied by all associated warranties, conditions, limitations, and notices. TI is not responsible or liable for such reproduced documentation. Information of third parties may be subject to additional restrictions. Resale of TI products or services with statements different from or beyond the parameters stated by TI for that product or service voids all express and any implied warranties for the associated TI product or service and is an unfair and deceptive business practice. TI is not responsible or liable for any such statements.

Buyers and others who are developing systems that incorporate TI products (collectively, "Designers") understand and agree that Designers remain responsible for using their independent analysis, evaluation and judgment in designing their applications and that Designers have full and exclusive responsibility to assure the safety of Designers' applications and compliance of their applications (and of all TI products used in or for Designers' applications) with all applicable regulations, laws and other applicable requirements. Designer represents that, with respect to their applications, Designer has all the necessary expertise to create and implement safeguards that (1) anticipate dangerous consequences of failures, (2) monitor failures and their consequences, and (3) lessen the likelihood of failures that might cause harm and take appropriate actions. Designer agrees that prior to using or distributing any applications that include TI products, Designer will thoroughly test such applications and the functionality of such TI products as used in such applications.

TI's provision of technical, application or other design advice, quality characterization, reliability data or other services or information, including, but not limited to, reference designs and materials relating to evaluation modules, (collectively, "TI Resources") are intended to assist designers who are developing applications that incorporate TI products; by downloading, accessing or using TI Resources in any way, Designer (individually or, if Designer is acting on behalf of a company, Designer's company) agrees to use any particular TI Resource solely for this purpose and subject to the terms of this Notice.

TI's provision of TI Resources does not expand or otherwise alter TI's applicable published warranties or warranty disclaimers for TI products, and no additional obligations or liabilities arise from TI providing such TI Resources. TI reserves the right to make corrections, enhancements, improvements and other changes to its TI Resources. TI has not conducted any testing other than that specifically described in the published documentation for a particular TI Resource.

Designer is authorized to use, copy and modify any individual TI Resource only in connection with the development of applications that include the TI product(s) identified in such TI Resource. NO OTHER LICENSE, EXPRESS OR IMPLIED, BY ESTOPPEL OR OTHERWISE TO ANY OTHER TI INTELLECTUAL PROPERTY RIGHT, AND NO LICENSE TO ANY TECHNOLOGY OR INTELLECTUAL PROPERTY RIGHT OF TI OR ANY THIRD PARTY IS GRANTED HEREIN, including but not limited to any patent right, copyright, mask work right, or other intellectual property right relating to any combination, machine, or process in which TI products or services are used. Information regarding or referencing third-party products or services does not constitute a license to use such products or services, or a warranty or endorsement thereof. Use of TI Resources may require a license from a third party under the patents or other intellectual property of the third party, or a license from TI under the patents or other intellectual property of TI.

TI RESOURCES ARE PROVIDED "AS IS" AND WITH ALL FAULTS. TI DISCLAIMS ALL OTHER WARRANTIES OR REPRESENTATIONS, EXPRESS OR IMPLIED, REGARDING RESOURCES OR USE THEREOF, INCLUDING BUT NOT LIMITED TO ACCURACY OR COMPLETENESS, TITLE, ANY EPIDEMIC FAILURE WARRANTY AND ANY IMPLIED WARRANTIES OF MERCHANTABILITY, FITNESS FOR A PARTICULAR PURPOSE, AND NON-INFRINGEMENT OF ANY THIRD PARTY INTELLECTUAL PROPERTY RIGHTS. TI SHALL NOT BE LIABLE FOR AND SHALL NOT DEFEND OR INDEMNIFY DESIGNER AGAINST ANY CLAIM, INCLUDING BUT NOT LIMITED TO ANY INFRINGEMENT CLAIM THAT RELATES TO OR IS BASED ON ANY COMBINATION OF PRODUCTS EVEN IF DESCRIBED IN TI RESOURCES OR OTHERWISE. IN NO EVENT SHALL TI BE LIABLE FOR ANY ACTUAL, DIRECT, SPECIAL, COLLATERAL, INDIRECT, PUNITIVE, INCIDENTAL, CONSEQUENTIAL OR EXEMPLARY DAMAGES IN CONNECTION WITH OR ARISING OUT OF TI RESOURCES OR USE THEREOF, AND REGARDLESS OF WHETHER TI HAS BEEN ADVISED OF THE POSSIBILITY OF SUCH DAMAGES.

Unless TI has explicitly designated an individual product as meeting the requirements of a particular industry standard (e.g., ISO/TS 16949 and ISO 26262), TI is not responsible for any failure to meet such industry standard requirements.

Where TI specifically promotes products as facilitating functional safety or as compliant with industry functional safety standards, such products are intended to help enable customers to design and create their own applications that meet applicable functional safety standards and requirements. Using products in an application does not by itself establish any safety features in the application. Designers must ensure compliance with safety-related requirements and standards applicable to their applications. Designer may not use any TI products in life-critical medical equipment unless authorized officers of the parties have executed a special contract specifically governing such use. Life-critical medical equipment is medical equipment where failure of such equipment would cause serious bodily injury or death (e.g., life support, pacemakers, defibrillators, heart pumps, neurostimulators, and implantables). Such equipment includes, without limitation, all medical devices identified by the U.S. Food and Drug Administration as Class III devices and equivalent classifications outside the U.S.

TI may expressly designate certain products as completing a particular qualification (e.g., Q100, Military Grade, or Enhanced Product). Designers agree that it has the necessary expertise to select the product with the appropriate qualification designation for their applications and that proper product selection is at Designers' own risk. Designers are solely responsible for compliance with all legal and regulatory requirements in connection with such selection.

Designer will fully indemnify TI and its representatives against any damages, costs, losses, and/or liabilities arising out of Designer's non-compliance with the terms and provisions of this Notice.