

FEATURES

- Nonreflective 50 Ω design**
- Low insertion loss: 0.8 dB at 8 GHz**
- High isolation: 45 dB at 8 GHz**
- High input linearity**
 - P1dB: 39 dBm**
 - IP3: 60 dBm typical**
- High power handling**
 - 35 dBm insertion loss path**
 - 27 dBm hot switching**
- ESD rating: 2 kV (Class 2) HBM**
- No low frequency spurious**
- 0.05 dB RF settling time: 375 ns**
- 0.1 dB RF settling time: 300 ns**
- 16-lead, 3 mm \times 3 mm LFCSP**
- Pin-compatible with [HMC1118](#), low frequency cutoff version**

APPLICATIONS

- Test instrumentation**
- Microwave radios and very small aperture terminals (VSATs)**
- Military radios, radars, and electronic counter measures (ECMs)**
- Fiber optics and broadband telecommunications**

GENERAL DESCRIPTION

The ADRF5019 is a nonreflective, single pole, double throw (SPDT) RF switch manufactured in a silicon process.

The ADRF5019 operates from 100 MHz to 13 GHz with better than 0.8 dB insertion loss and 45 dB of isolation at 8 GHz. The ADRF5019 has a nonreflective design, and the RF ports are internally terminated to 50 Ω .

The ADRF5019 switch requires a dual supply voltage of +3.3 V and -2.5 V and positive control voltage inputs. This switch employs complementary metal-oxide semiconductor (CMOS)-compatible and low voltage transistor transistor logic (LVTTL)-compatible controls.

FUNCTIONAL BLOCK DIAGRAM

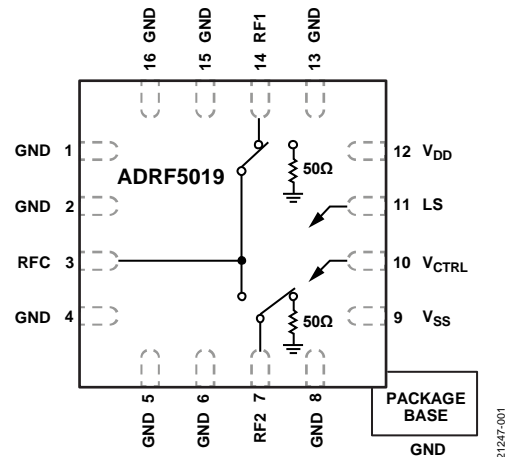

Figure 1.

The ADRF5019 can also operate with a single positive supply voltage (V_{DD}) applied. The negative supply voltage (V_{SS}) is tied to ground. Even in single-supply operation mode, the ADRF5019 can cover the 100 MHz to 13 GHz operating frequency and maintain good power handling performance. See the Applications Information section for more details.

The ADRF5019 is pin-compatible with the [HMC1118](#), the low frequency cutoff version, which operates from 9 kHz to 13.0 GHz.

The ADRF5019 comes in a 16-lead, lead frame chip scale package (LFCSP) and operates from -40°C to +105°C.

TABLE OF CONTENTS

Features	1	Typical Performance Characteristics	7
Applications.....	1	Insertion Loss, Return Loss, and Isolation	7
Functional Block Diagram	1	Input Compression and Input Third-Order Intercept	8
General Description	1	Theory of Operation	10
Revision History	2	RF Input and Output	10
Specifications.....	3	Power Supply.....	10
Electrical Specifications.....	3	Applications Information	11
Absolute Maximum Ratings.....	5	Layout Considerations.....	11
Thermal Resistance	5	Board Layout.....	11
Power Derating Curves.....	5	RF and Digital Controls	11
ESD Caution.....	5	Outline Dimensions	12
Pin Configuration and Function Descriptions.....	6	Ordering Guide	12
Interface Schematics.....	6		

REVISION HISTORY

8/2019—Revision 0: Initial Version

SPECIFICATIONS

ELECTRICAL SPECIFICATIONS

$V_{DD} = 3.3\text{ V}$, $V_{SS} = -2.5\text{ V}$, $LS = 3.3\text{ V}$, $V_{CTRL} = 0\text{ V}$ or 3.3 V , and $T_{CASE} = 25^\circ\text{C}$ in a $50\ \Omega$ system, unless otherwise noted.

Table 1.

Parameter	Symbol	Test Conditions/Comments	Min	Typ	Max	Unit
FREQUENCY RANGE	f		100		13,000	MHz
INSERTION LOSS	IL					
Between RFC and RF1 or RFC and RF2 (On)		100 MHz to 3 GHz		0.6		dB
		100 MHz to 8 GHz		0.8		dB
		100 MHz to 10 GHz		1.0		dB
		100 MHz to 13 GHz		1.5		dB
RETURN LOSS	RL					
Between RFC and RF1 or RFC and RF2 (On)		100 MHz to 3 GHz		26		dB
		100 MHz to 8 GHz		22		dB
		100 MHz to 13 GHz		9		dB
RF1 or RF2 (Off)		100 MHz to 3 GHz		26		dB
		100 MHz to 8 GHz		14		dB
		100 MHz to 13 GHz		5		dB
ISOLATION						
Between RFC and RF1 or RCF and RF2 (Off)		100 MHz to 3 GHz		50		dB
		100 MHz to 8 GHz		45		dB
		100 MHz to 10 GHz		35		dB
		100 MHz to 13 GHz		25		dB
SWITCHING CHARACTERISTICS						
Dual Supply		$V_{DD} = 3.3\text{ V}$, $V_{SS} = -2.5\text{ V}$				
Rise Time and Fall Time	t_{RISE} , t_{FALL}	10% to 90% of RF output		35		ns
On Time and Off Time	t_{ON} , t_{OFF}	50% of triggered digital control input voltage (V_{CTL}) to 90% of RF output		150		ns
RF Settling Time						
0.1 dB		50% of triggered V_{CTL} to 0.1 dB of final RF output		300		ns
0.05 dB		50% of triggered V_{CTL} to 0.05 dB of final RF output		375		ns
Single Supply		$V_{DD} = 3.3\text{ V}$, $V_{SS} = 0\text{ V}$				
Rise Time and Fall Time	t_{RISE} , t_{FALL}	10% to 90% of RF output		180		ns
On Time and Off Time	t_{ON} , t_{OFF}	50% of triggered V_{CTL} to 90% of RF output		285		ns
INPUT LINEARITY ¹						
Dual Supply		$V_{DD} = 3.3\text{ V}$, $V_{SS} = -2.5\text{ V}$				
Input Compression						
0.1 dB	P0.1dB			38		dBm
1 dB	P1dB			39		dBm
Intermodulation Distortion						
Input Third-Order Intercept	IIP3	Two tone input power = 12 dBm each tone, $\Delta f = 1\text{ MHz}$		60		dBm
Single Supply		$V_{DD} = 3.3\text{ V}$, $V_{SS} = 0\text{ V}$				
Input Compression						
0.1 dB	P0.1dB			25		dBm
1 dB	P1dB			28		dBm
Intermodulation Distortion						
Input Third-Order Intercept	IIP3	Two tone input power = 12 dBm each tone, $\Delta f = 1\text{ MHz}$		55		dBm
SUPPLY CURRENT		V_{DD} pin and V_{SS} pin				
Positive Supply Current	I_{DD}			20		μA
Negative Supply Current	I_{SS}			0.5		μA

Parameter	Symbol	Test Conditions/Comments	Min	Typ	Max	Unit
DIGITAL CONTROL INPUTS						
Voltage						
Low	V_{INL}	V_{CTRL} pin and LS pin	0		0.8	V
High	V_{INH}		2		3.3	V
Current						
Low and High Current	I_{INL}, I_{INH}			<1		μ A
RECOMMENDED OPERATING CONDITONS						
Supply Voltage						
Positive	V_{DD}		3.0		3.6	V
Negative	V_{SS}		-2.75		-2.25	V
Digital Control Input Voltage	V_{CTL}		0		V_{DD}	V
RF Input Power, Dual Supply ²	P_{IN}	$V_{DD} = 3.3$ V, $V_{SS} = -2.5$ V, $f = 2$ GHz, $T_{CASE} = 85^{\circ}$ C ³ RF signal is applied to RFC or through connected RF1 or RF2			35	dBm
Insertion Loss Path						
Isolation Path					27	
Hot Switching		RF signal is applied to the terminated RF1 or RF2 between RF1 and RF2			27	dBm
RF Input Power, Single Supply ²	P_{IN}	$V_{DD} = 3.3$ V, $V_{SS} = 0$ V, $f = 2$ GHz, $T_{CASE} = 85^{\circ}$ C ³ RF signal is applied to RFC or through connected RF1 or RF2			27	dBm
Insertion Loss Path						
Isolation Path					22	
Hot Switching		RF signal is applied to the terminated RF1 or RF2 between RF1 and RF2			22	dBm
Case Temperature	T_{CASE}		-40		+105	$^{\circ}$ C

¹ For input linearity performance vs. frequency, see Figure 13 to Figure 20.

² For power derating vs. frequency, see Figure 2 and Figure 3. Power derating is applicable for insertion loss path, terminated path, and hot switching power specifications.

³ For operation at 105 $^{\circ}$ C, the power handling degrades from the $T_{CASE} = 85^{\circ}$ C specification by 3 dB.

ABSOLUTE MAXIMUM RATINGS

Table 2.

Parameter	Rating
Positive Supply Voltage	-0.3 V to +3.7 V
Negative Supply Voltage	-2.8 V to +0.3 V
Digital Control Inputs	
Voltage	-0.3 V to $V_{DD} + 0.3$ V
Current	3 mA
RF Input Power, Dual Supply ¹ ($V_{DD} = 3.3$ V, $V_{SS} = -2.5$ V, $f = 2$ GHz at $T_{CASE} = 85^{\circ}C^2$)	
Insertion Loss Path	37 dBm
Isolation Path	28 dBm
Hot Switching	30 dBm
RF Input Power, Dual Supply ¹ ($V_{DD} = 3.3$ V, $V_{SS} = 0$ V, $f = 2$ GHz at $T_{CASE} = 85^{\circ}C^2$)	
Insertion Loss Path	28 dBm
Isolation Path	23 dBm
Hot Switching	23 dBm
RF Input Power Under Unbiased Condition ($V_{DD}, V_{SS} = 0$ V)	23 dBm
Temperature	
Junction, T_J	135°C
Storage Range	-65°C to +150°C
Reflow	260°C
Electrostatic Discharge (ESD) Sensitivity	
Human Body Model (HBM)	2 kV (Class 2)

¹ For power derating vs. frequency, see Figure 2 and Figure 3. Power derating is applicable for insertion loss path, terminated path, and hot switching power specifications.

² For operation at 105°C, the power handling degrades from the $T_{CASE} = 85^{\circ}C$ specification by 3 dB.

Stresses at or above those listed under Absolute Maximum Ratings may cause permanent damage to the product. This is a stress rating only; functional operation of the product at these or any other conditions above those indicated in the operational section of this specification is not implied. Operation beyond the maximum operating conditions for extended periods may affect product reliability.

THERMAL RESISTANCE

Thermal resistance is directly linked to printed circuit board (PCB) design and operating environment. Careful attention to PCB thermal design is required.

θ_{JC} is the junction to case bottom (channel to package bottom) thermal resistance.

Table 3. Thermal Resistance

Package Type	θ_{JC}	Unit
CP-16-38		
Through Path	106	°C/W
Terminated Path	100	°C/W

POWER DERATING CURVES

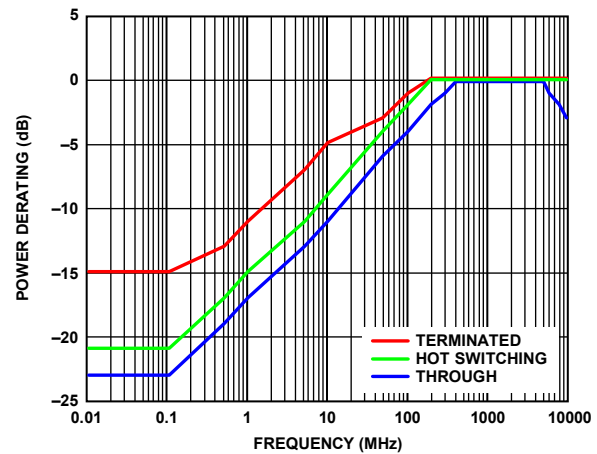

Figure 2. Power Derating vs. Frequency, Low Frequency Detail, $T_{CASE} = 85^{\circ}C$

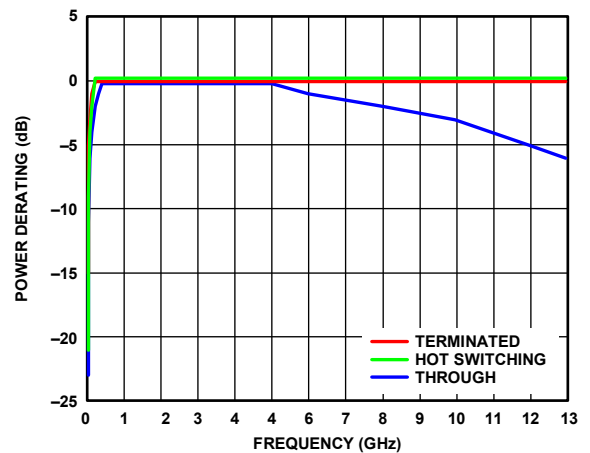

Figure 3. Power Derating vs. Frequency, High Frequency Detail, $T_{CASE} = 85^{\circ}C$

ESD CAUTION



ESD (electrostatic discharge) sensitive device. Charged devices and circuit boards can discharge without detection. Although this product features patented or proprietary protection circuitry, damage may occur on devices subjected to high energy ESD. Therefore, proper ESD precautions should be taken to avoid performance degradation or loss of functionality.

PIN CONFIGURATION AND FUNCTION DESCRIPTIONS

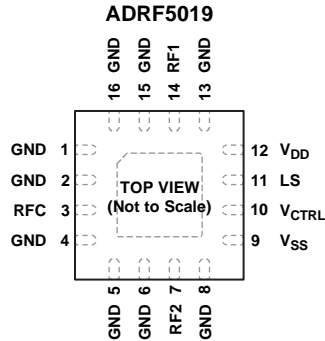

NOTES
 1. EXPOSED PAD. THE EXPOSED PAD MUST BE CONNECTED TO THE RF AND DC GROUND OF THE PCB.

Figure 4. Pin Configuration (Top View)

Table 4. Pin Function Descriptions

Pin No.	Mnemonic	Description
1, 2, 4 to 6, 8, 13, 15, 16	GND	Ground. These pins must be connected to the RF and dc ground of the PCB.
3	RFC	RF Common Port. This pin is dc-coupled to 0 V and ac matched to 50 Ω. No dc blocking capacitor is required when the RF line potential is equal to 0 V dc. See Figure 5 for the interface schematic.
7	RF2	RF Throw Port 2. This pin is dc-coupled to 0 V and ac matched to 50 Ω. No dc blocking capacitor is required when the RF line potential is equal to 0 V dc. See Figure 5 for the interface schematic.
9	V _{SS}	Negative Supply Voltage Pin. See Figure 8 for the interface schematic.
10	V _{CTRL}	Control Input Pin. See Figure 6 for interface schematic. See Table 5 for the truth table.
11	LS	Logic Select Input Pin. See Figure 6 for the interface schematic. See Table 5 for the truth table.
12	V _{DD}	Positive Supply Voltage Pin. See Figure 7 for the interface schematic.
14	RF1	RF Throw Port 1. This pin is dc-coupled to 0 V and ac matched to 50 Ω. No dc blocking capacitor is required when the RF line potential is equal to 0 V dc. See Figure 5 for the interface schematic.
	EPAD	Exposed Pad. The exposed pad must be connected to the RF and dc ground of the PCB.

INTERFACE SCHEMATICS

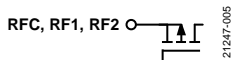

Figure 5. RFC, RF1, and RF2 Pin Interface Schematic

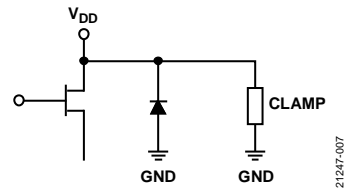

Figure 7. V_{DD} Pin Interface Schematic

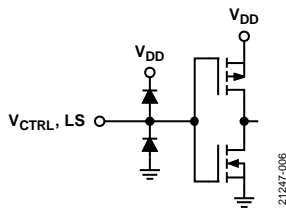

Figure 6. Digital Pins Interface Schematic

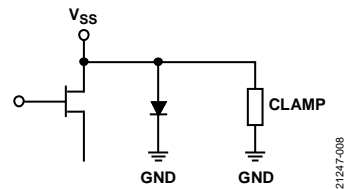

Figure 8. V_{SS} Pin Interface Schematic

TYPICAL PERFORMANCE CHARACTERICS

INSERTION LOSS, RETURN LOSS, AND ISOLATION

$V_{DD} = 3.3\text{ V}$, $V_{SS} = -2.5\text{ V}$, V_{CTRL} and $LS = 0\text{ V}$ or V_{DD} , and $T_{CASE} = 25^\circ\text{C}$ in a $50\ \Omega$ system, unless otherwise noted.

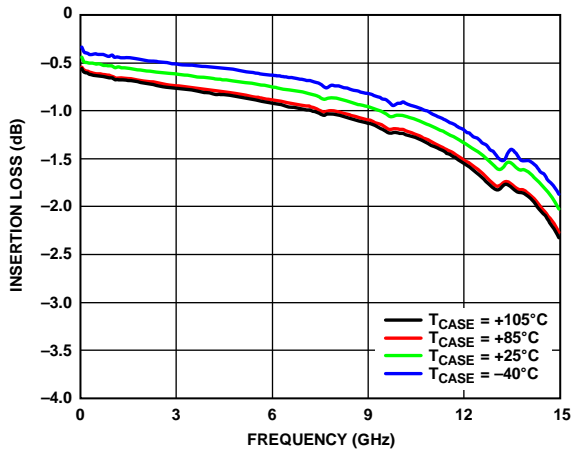

Figure 9. Insertion Loss vs. Frequency over Temperature

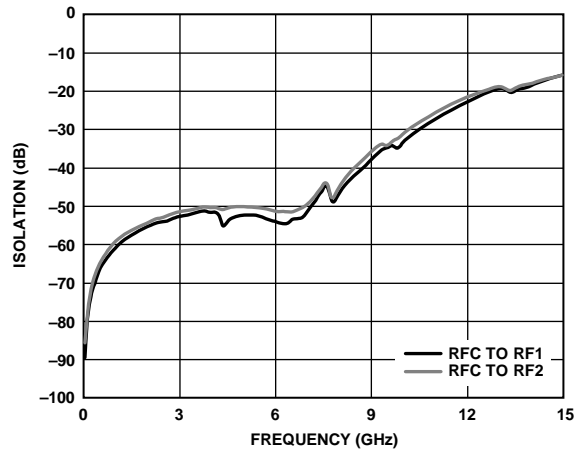

Figure 11. Isolation Between RFC and RFx Ports vs. Frequency

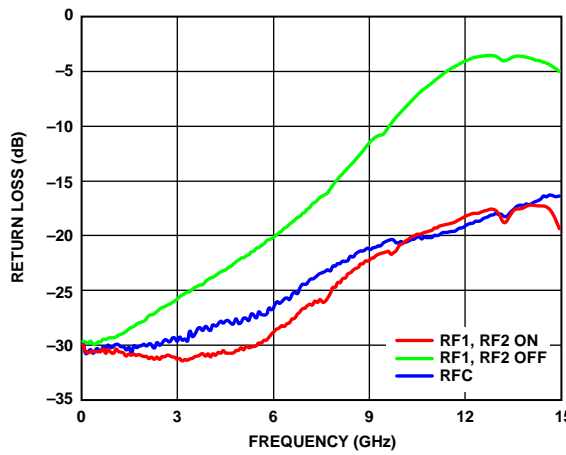

Figure 10. Return Loss vs. Frequency

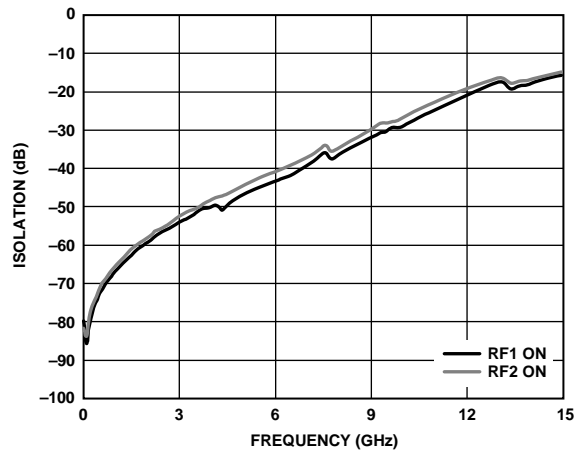

Figure 12. Isolation Between RF1 and RF2 Ports vs. Frequency

INPUT COMPRESSION AND INPUT THIRD-ORDER INTERCEPT

$V_{DD} = 3.3\text{ V}$, V_{CTRL} and $LS = 0\text{ V}$ or V_{DD} , and $T_{CASE} = 25^\circ\text{C}$ in a $50\ \Omega$ system, unless otherwise noted. All of the large signal performance parameters are measured on the [ADRF5019-EVALZ](#) evaluation board.

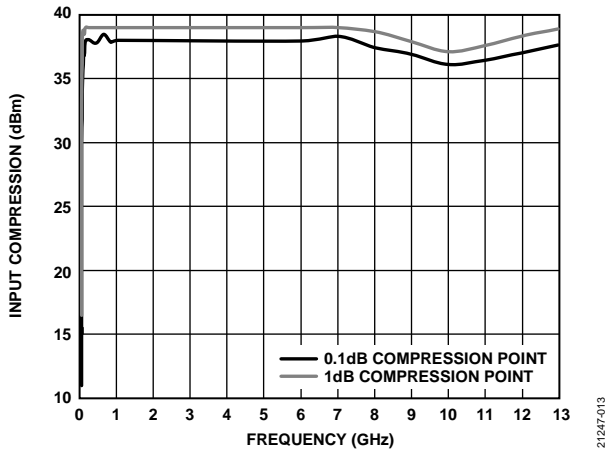

Figure 13. P0.1dB and P1dB Input Compression vs. Frequency, $V_{SS} = -2.5\text{ V}$

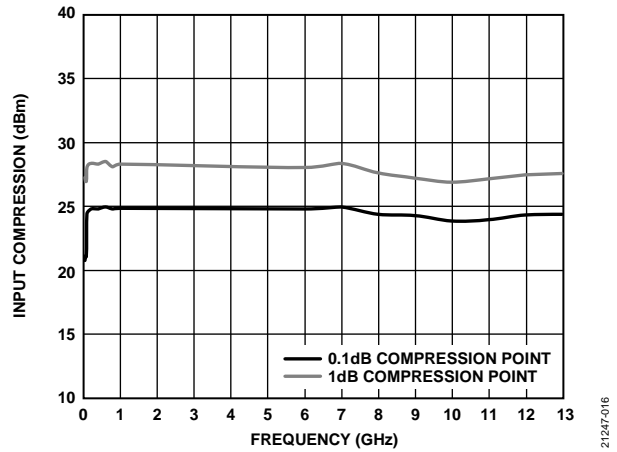

Figure 16. P0.1dB and P1dB Input Compression vs. Frequency, $V_{SS} = 0\text{ V}$

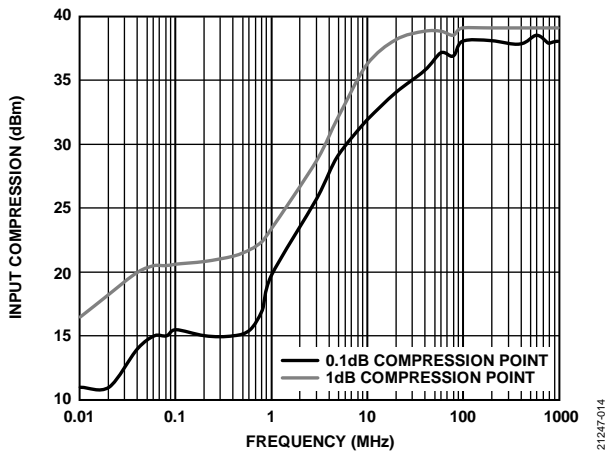

Figure 14. P0.1dB and P1dB Input Compression vs. Frequency (Low Frequency Detail), $V_{SS} = -2.5\text{ V}$

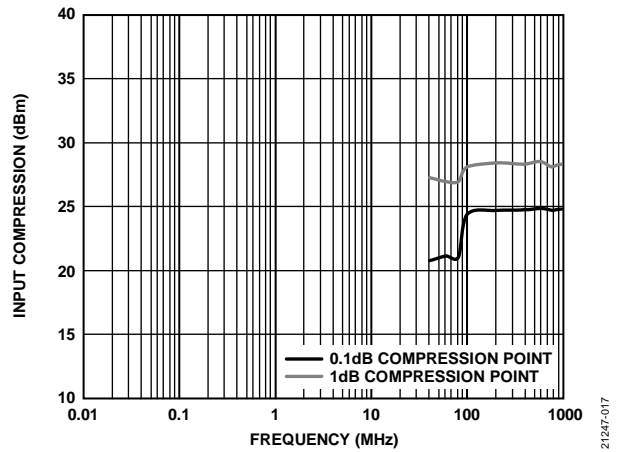

Figure 17. P0.1dB and P1dB Input Compression vs. Frequency (Low Frequency Detail), $V_{SS} = 0\text{ V}$

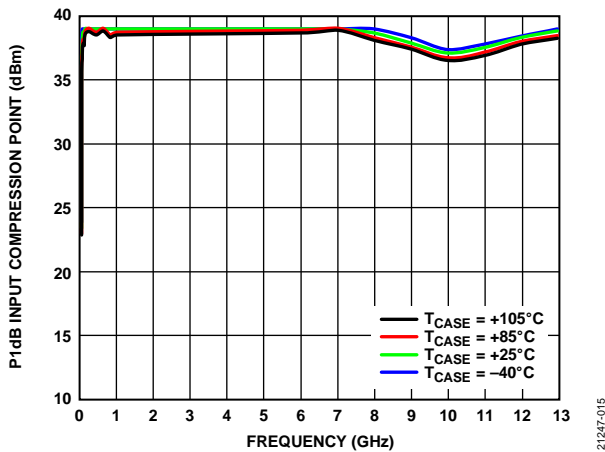

Figure 15. P1dB Input Compression Point vs. Frequency over Temperature, $V_{SS} = -2.5\text{ V}$

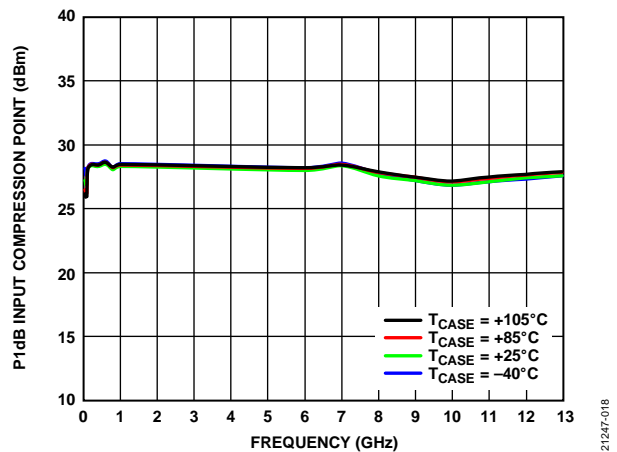

Figure 18. P1dB Input Compression Point vs. Frequency over Temperature (Low Frequency Detail), $V_{SS} = 0\text{ V}$

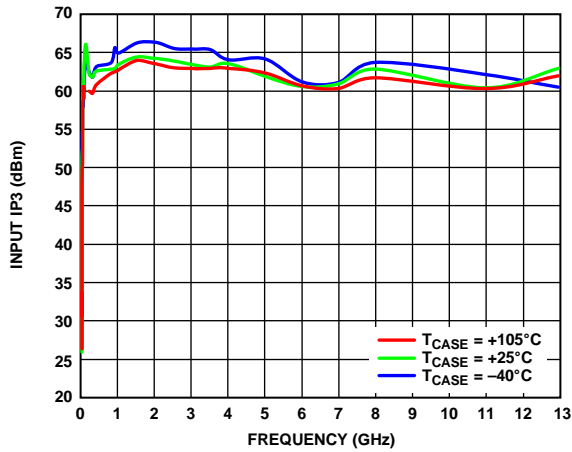

Figure 19. Input IP3 vs. Frequency over Temperature, $V_{SS} = -2.5 V$

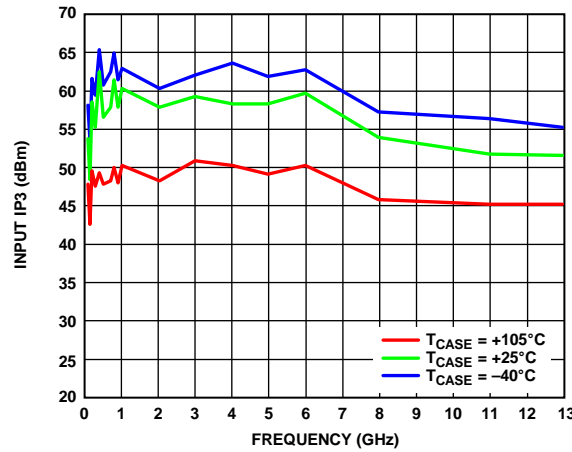

Figure 21. Input IP3 vs. Frequency over Temperature, $V_{SS} = 0 V$

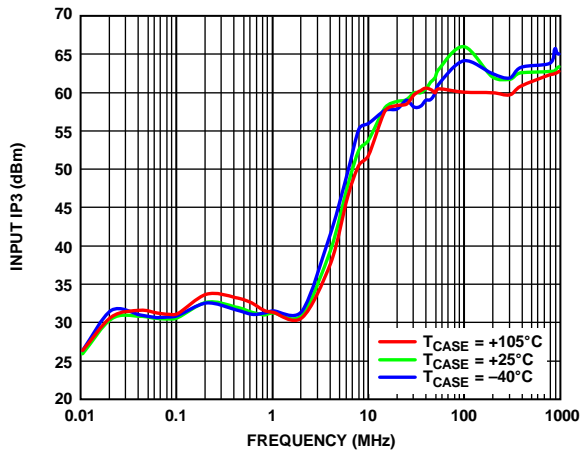

Figure 20. Input IP3 vs. Frequency over Temperature (Low Frequency Detail), $V_{SS} = -2.5 V$

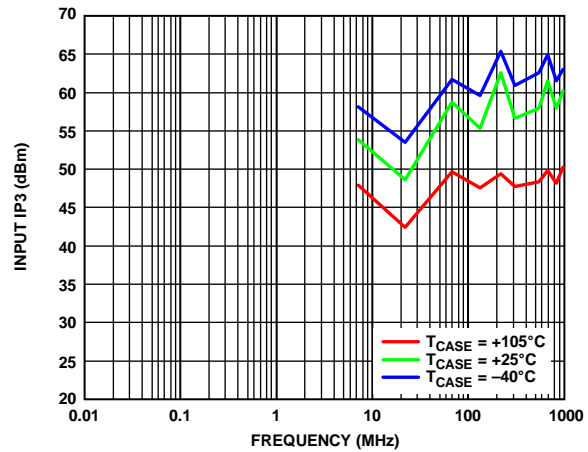

Figure 22. Input IP3 vs. Frequency over Temperature (Low Frequency Detail), $V_{SS} = 0 V$

THEORY OF OPERATION

The ADRF5019 integrates a driver to perform logic functions internally and to provide the user with the advantage of a simplified positive voltage control interface. The driver features two digital control input pins (V_{CTRL} and LS) that control the state of the RF paths, determining which RF port is in the insertion loss state and which path is in the isolation state (see Table 5).

RF INPUT AND OUTPUT

The RF ports (RFC, RF1, and RF2) are dc-coupled to 0 V, and no dc blocking is required at the RF ports when the RF line potential is equal to 0 V.

The RF ports are internally matched to 50 Ω . Therefore, external matching networks are not required.

The ADRF5019 is bidirectional with equal power handling capabilities. An RF input signal (RF_{IN}) can be applied to the RFC port or to the RF1 port or the RF2 port.

The insertion loss path conducts the RF signal between the selected RF throw port and the RF common port. The isolation path provides high loss between the insertion loss path and the unselected RF throw port, which is nonreflective, by using an internal 50 Ω termination resistor.

POWER SUPPLY

The ADRF5019 requires a positive supply voltage applied to the V_{DD} pin and a negative supply voltage applied to the V_{SS} pin. Bypassing capacitors are recommended on the supply lines to filter high frequency noise.

The ideal power-up sequence is as follows:

1. Connect to GND.
2. Power up the V_{DD} and V_{SS} voltages. Power up V_{SS} after V_{DD} to avoid current transients on V_{DD} during ramp up.
3. Power up the digital control inputs. The order of the digital control inputs is not important. However, powering the digital control inputs before the V_{DD} voltage supply can inadvertently forward bias and damage the internal ESD protection structures. To avoid this damage, use a series 1 k Ω resistor to limit the current flowing into the control pin. Use pull-up or pull-down resistors if the controller output is in a high impedance state after the V_{DD} voltage is powered up and the control pins are not driven to a valid logic state.
4. Apply an RF input signal to RFC, RF1, or RF2.

The ideal power-down sequence is the reverse order of the power-up sequence.

Single-Supply Operation

The ADRF5019 can operate with a single positive supply voltage applied to the V_{DD} pin and V_{SS} pin connected to ground. However, some performance degradations can occur in the input compression and input third-order intercept.

Table 5. Control Voltage Truth Table

Digital Control Inputs		RF Paths	
LS	V_{CTRL}	RF1 to RFC	RF2 to RFC
High	Low	Insertion loss (on)	Isolation (off)
High	High	Isolation (off)	Insertion loss (on)
Low	Low	Isolation (off)	Insertion loss (on)
Low	High	Insertion loss (on)	Isolation (off)

APPLICATIONS INFORMATION

LAYOUT CONSIDERATIONS

All measurements in this data sheet are measured on the [ADRF5019-EVALZ](#) evaluation board. The design of the [ADRF5019-EVALZ](#) board serves as a layout recommendation for ADRF5019 application.

See the [ADRF5019-EVALZ](#) user guide for more information on using the evaluation board.

BOARD LAYOUT

The [ADRF5019-EVALZ](#) is a 4-layer board. The outer copper (Cu) layers are 0.7 mil to 2.2 mil plated and are separated by dielectric materials. Figure 23 shows the [ADRF5019-EVALZ](#) board stack up.

The board layout and stackup shown in Figure 23 are used to make the measurements included in this data sheet.

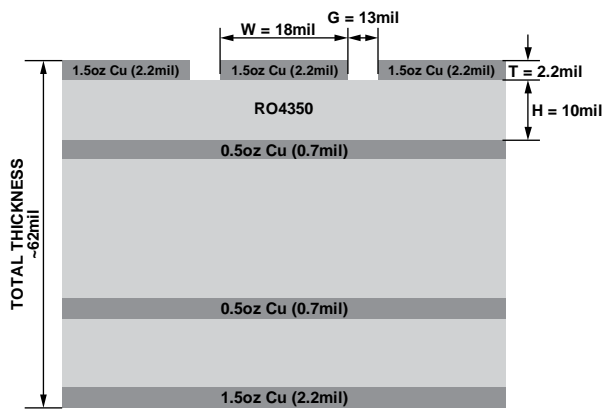

Figure 23. [ADRF5019-EVALZ](#) Stack Up

All RF and dc traces are routed on the top copper layer. The inner and bottom layers are ground planes that provide a solid ground for the RF transmission lines. The top dielectric material (H) is 10 mil Rogers RO4350, which allows optimal RF performance. The middle and bottom dielectric layers provide mechanical strength. The overall evaluation board thickness is approximately 62 mil, which allows Subminiature Version A (SMA) connectors to be connected at the board edges.

RF AND DIGITAL CONTROLS

The RF transmission lines use a coplanar waveguide (CPWG) model with a width of 18 mil and a ground spacing (G) of 13 mil and have a characteristic impedance of 50 Ω. For optimal RF and thermal grounding, as many plated through vias as possible are arranged around the transmission lines and under the exposed pad of the package.

The RF input and output ports (RFC, RF1, and RF2) are connected through 50 Ω transmission lines to the SMA launchers. On the V_{DD} and V_{SS} supply traces, a 100 pF bypass capacitor filters high frequency noise.

Figure 24 shows the simplified application circuit for the ADRF5019.

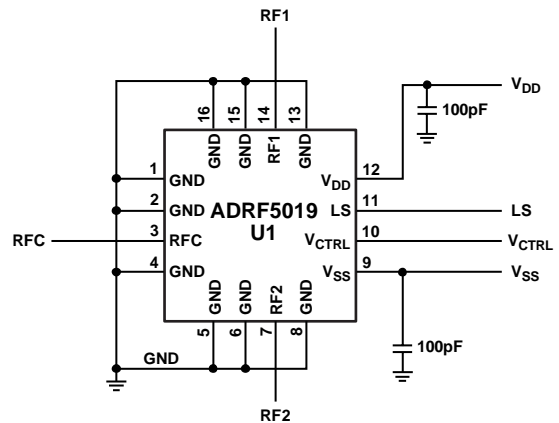
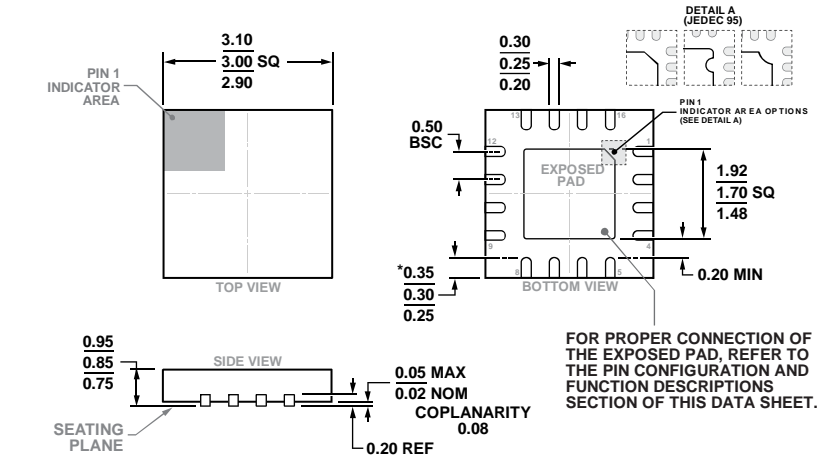

Figure 24. Simplified Application Circuit

OUTLINE DIMENSIONS



*COMPLIANT WITH JEDEC STANDARDS MO-220-VEED-4 WITH THE EXCEPTION OF PACKAGE EDGE TO LEAD EDGE.

Figure 25. 16-Lead Lead Frame Chip Scale Package [LFCSP]
 3 mm x 3 mm Body and 0.85 mm Package Height
 (CP-16-38)
 Dimensions shown in millimeters

ORDERING GUIDE

Model ¹	Temperature Range	Package Description	Package Option	Marking Code
ADRF5019BCPZN	-40°C to +105°C	16-Lead Lead Frame Chip Scale Package [LFCSP]	CP-16-38	S4Z
ADRF5019BCPZN-R7	-40°C to +105°C	16-Lead Lead Frame Chip Scale Package [LFCSP]	CP-16-38	S4Z
ADRF5019-EVALZ		Evaluation Board		

¹ Z = RoHS Compliant Part.