

FEATURES

- Low power: 180 μ A typical**
- Very low input bias currents: 0.5 pA typical**
- Low noise: 16 nV/ $\sqrt{\text{Hz}}$ typical**
- 3.6 MHz bandwidth**
- Offset voltage: 500 μ V typical**
- Low offset voltage drift: 4 μ V/ $^{\circ}$ C maximum**
- Low distortion: 0.003% THD + N**
- 2.7 V to 5 V single supply or ± 1.35 V to ± 2.5 V dual supply**
- Available in very small 2 mm \times 2 mm LFCSP packages**

APPLICATIONS

- Photodiode amplifiers**
- Sensor amplifiers**
- Portable medical and instrumentation**
- Portable audio: MP3s, PDAs, and smartphones**
- Communications**
- Low-side current sense**
- ADC drivers**
- Active filters**
- Sample-and-hold**

GENERAL DESCRIPTION

The ADA4691-2/ADA4692-2 are dual and the ADA4691-4/ADA4692-4 are the quad rail-to-rail output, single-supply amplifiers featuring low power, wide bandwidth, and low noise. The ADA4691-2 has two independent shutdown pins, allowing further reduction in supply current. The ADA4691-4 is a quad with dual shutdown pins each controlling a pair of amplifiers and is available in the 16-lead LFCSP. The ADA4692-4 is a quad version without shutdown.

These amplifiers are ideal for a wide variety of applications. Audio, filters, photodiode amplifiers, and charge amplifiers, all benefit from this combination of performance and features. Additional applications for these amplifiers include portable consumer audio players with low noise and low distortion that provide high gain and slew rate response over the audio band at low power. Industrial applications with high impedance sensors, such as piezoelectric and IR sensors, benefit from the high impedance and low 0.5 pA input bias, low offset drift, and enough bandwidth and response for low gain applications.

Table 1.

| | Micropower | Low Power | Low Power with Shutdown | Standard Op Amp With Shutdown | High Bandwidth |
|--------|------------|-----------|-------------------------|-------------------------------|----------------|
| Single | AD8613 | | | AD8591 | AD8691 |
| Dual | AD8617 | ADA4692-2 | ADA4691-2 | AD8592 | AD8692 |
| Quad | AD8619 | ADA4692-4 | ADA4691-4 | | AD8694 |

The ADA4691/ADA4692 family is fully specified over the extended industrial temperature range (-40°C to $+125^{\circ}\text{C}$). The ADA4691-2 is available in a 10-lead LFCSP and a 9-ball WLCSP. The ADA4692-2 is available in an 8-lead SOIC and 8-lead LFCSP. The ADA4691-4 is available in a 16-lead LFCSP. The ADA4692-4 is available in a 14-lead TSSOP. For pin configurations, see the Pin Configurations section.

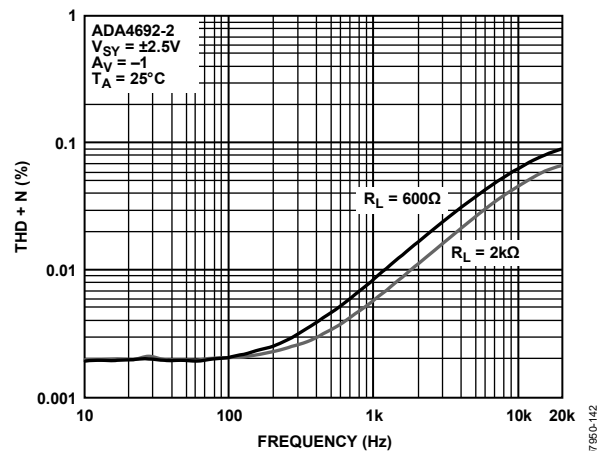

Figure 1. THD + Noise vs. Frequency

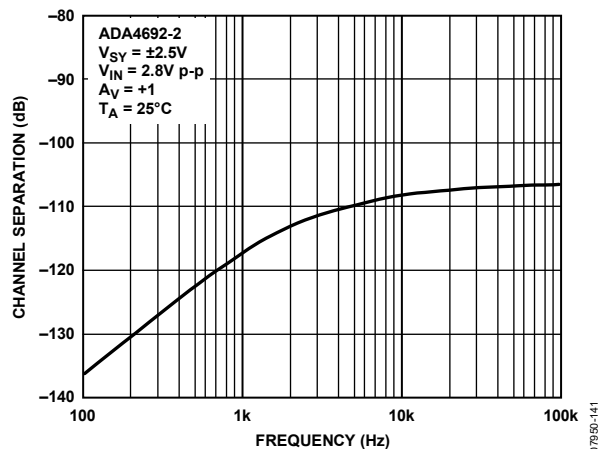

Figure 2. Channel Separation vs. Frequency

Rev. E

[Document Feedback](#)

Information furnished by Analog Devices is believed to be accurate and reliable. However, no responsibility is assumed by Analog Devices for its use, nor for any infringements of patents or other rights of third parties that may result from its use. Specifications subject to change without notice. No license is granted by implication or otherwise under any patent or patent rights of Analog Devices. Trademarks and registered trademarks are the property of their respective owners.

One Technology Way, P.O. Box 9106, Norwood, MA 02062-9106, U.S.A.
 Tel: 781.329.4700 ©2009–2019 Analog Devices, Inc. All rights reserved.
[Technical Support](#) www.analog.com

TABLE OF CONTENTS

| | | | |
|--|---|---|----|
| Features | 1 | ESD Caution..... | 6 |
| Applications..... | 1 | Pin Configurations..... | 7 |
| General Description | 1 | Typical Performance Characteristics | 8 |
| Revision History | 2 | Shutdown Operation..... | 16 |
| Specifications..... | 3 | Input Pin Characteristics..... | 16 |
| Electrical Characteristics—2.7 V Operation | 3 | Input Threshold..... | 16 |
| Electrical Characteristics—5 V Operation..... | 4 | Outline Dimensions | 17 |
| Absolute Maximum Ratings..... | 6 | Ordering Guide | 19 |
| Thermal Resistance | 6 | | |

REVISION HISTORY

12/2019—Rev. D to Rev. E

| | |
|----------------------------------|----|
| Changes to Table 1..... | 1 |
| Changes to Table 2..... | 3 |
| Changes to Table 3..... | 5 |
| Updated Outline Dimensions | 17 |
| Changes to Ordering Guide | 19 |

11/2010—Rev. C to Rev. D

| | |
|---|---|
| Changed 5 V to 6 V in Endnote 2, Table 4..... | 6 |
|---|---|

12/2009—Rev. B to Rev. C

| | |
|---|------------|
| Added ADA4691-4, 16-Lead LFCSP | Throughout |
| Added Figure 1, Figure 2, and Table 1; Renumbered Sequentially | 1 |
| Changes to Applications Section and General Description Section..... | 1 |
| Changes to Table 1..... | 3 |
| Changes to Table 2..... | 4 |
| Changes to Table 4..... | 6 |
| Updated Outline Dimensions | 17 |
| Changes to Ordering Guide | 20 |

9/2009—Rev. A to Rev. B

| | |
|--|------------|
| Added ADA4691-2, 9-Ball WLCSP; ADA4692-2, 8-Lead LFCSP; and ADA4692-4, 14-Lead TSSOP..... | Throughout |
| Changes to General Description | 1 |
| Updated Outline Dimensions..... | 16 |
| Changes to Ordering Guide | 17 |

6/2009—Rev. 0 to Rev. A

| | |
|---|------------|
| Added ADA4691-2, 10 Lead LFCSP..... | Throughout |
| Changes to Table 1..... | 3 |
| Changes to Table 2..... | 4 |
| Changes to Captions for Figure 40, Figure 41, Figure 43, and Figure 44 | 13 |
| Added Shutdown Operations Section | 15 |
| Updated Outline Dimensions..... | 16 |
| Changes to Ordering Guide | 16 |

3/2009—Revision 0: Initial Version

SPECIFICATIONS

ELECTRICAL CHARACTERISTICS—2.7 V OPERATION

Supply voltage (V_{SY}) = 2.7 V, common-mode voltage (V_{CM}) = $V_{SY}/2$, $T_A = 25^\circ\text{C}$, unless otherwise specified.

Table 2.

| Parameter | Symbol | Test Conditions/Comments | Min | Typ | Max | Unit |
|--------------------------------|--------------------------|---|------|----------|------|------------------------------|
| INPUT CHARACTERISTICS | | | | | | |
| Offset Voltage | V_{OS} | $V_{CM} = -0.3\text{ V to }+1.6\text{ V}$ | | 0.5 | 2.5 | mV |
| Dual (ADA469x-2) | | $V_{CM} = -0.1\text{ V to }+1.6\text{ V}; -40^\circ\text{C} < T_A < +125^\circ\text{C}$ | | | 3.5 | mV |
| Quad (ADA469x-4) | | $V_{CM} = -0.1\text{ V to }+1.6\text{ V}; -40^\circ\text{C} < T_A < +125^\circ\text{C}$ | | | 4.0 | mV |
| Offset Voltage Drift | $\Delta V_{OS}/\Delta T$ | $-40^\circ\text{C} < T_A < +125^\circ\text{C}$ | | 1 | 4 | $\mu\text{V}/^\circ\text{C}$ |
| Input Bias Current | I_B | $-40^\circ\text{C} < T_A < +125^\circ\text{C}$ | | 0.5 | 5 | pA |
| Input Offset Current | I_{OS} | $-40^\circ\text{C} < T_A < +125^\circ\text{C}$ | | 1 | 8 | pA |
| Input Voltage Range | | $-40^\circ\text{C} < T_A < +125^\circ\text{C}$ | -0.3 | | +1.6 | V |
| Common-Mode Rejection Ratio | CMRR | $V_{CM} = -0.3\text{ V to }+1.6\text{ V}$ | 70 | 90 | | dB |
| | | $V_{CM} = -0.1\text{ V to }+1.6\text{ V}; -40^\circ\text{C} < T_A < +125^\circ\text{C}$ | 62 | | | dB |
| Large Signal Voltage Gain | A_{VO} | Load resistance (R_L) = 2 k Ω , output voltage (V_{OUT}) = 0.5 V to 2.2 V | 90 | 100 | | dB |
| | | $-40^\circ\text{C} < T_A < +85^\circ\text{C}$ | 80 | | | dB |
| | | $-40^\circ\text{C} < T_A < +125^\circ\text{C}$ | 63 | | | dB |
| | | $R_L = 600\ \Omega, V_{OUT} = 0.5\text{ V to }2.2\text{ V}$ | 85 | 95 | | dB |
| Input Capacitance | C_{IN} | | | | | |
| Differential Mode | C_{INDM} | | | 2.5 | | pF |
| Common Mode | C_{INCM} | | | 7 | | pF |
| Logic High Voltage (Enabled) | V_{IH} | $-40^\circ\text{C} < T_A < +125^\circ\text{C}$ | 1.6 | | | V |
| Logic Low Voltage (Power-Down) | V_{IL} | $-40^\circ\text{C} < T_A < +125^\circ\text{C}$ | | | 0.5 | V |
| Logic Input Current (Per Pin) | I_{IN} | $-40^\circ\text{C} < T_A < +125^\circ\text{C}, 0\text{ V} \leq \text{shutdown voltage } (V_{SD}) \leq 2.7\text{ V}$ | | | 1 | μA |
| OUTPUT CHARACTERISTICS | | | | | | |
| Output Voltage High | V_{OH} | $R_L = 2\text{ k}\Omega \text{ to } V_{CM}$ | 2.65 | 2.67 | | V |
| | | $-40^\circ\text{C} < T_A < +125^\circ\text{C}$ | 2.6 | | | V |
| | | $R_L = 600\ \Omega \text{ to } V_{CM}$ | 2.55 | 2.59 | | V |
| | | $-40^\circ\text{C} < T_A < +125^\circ\text{C}$ | 2.5 | | | V |
| Output Voltage Low | V_{OL} | $R_L = 2\text{ k}\Omega \text{ to } V_{CM}$ | | 24 | 33 | mV |
| | | $-40^\circ\text{C} < T_A < +125^\circ\text{C}$ | | | 43 | mV |
| | | $R_L = 600\ \Omega \text{ to } V_{CM}$ | | 78 | 103 | mV |
| | | $-40^\circ\text{C} < T_A < +125^\circ\text{C}$ | | | 138 | mV |
| Short-Circuit Current | I_{SC} | $V_{OUT} = V_{SY} \text{ or GND}$ | | ± 15 | | mA |
| Closed-Loop Output Impedance | Z_{OUT} | Frequency (f) = 1 MHz, voltage gain (A_v) = -100 | | 372 | | Ω |
| Output Pin Leakage Current | | $-40^\circ\text{C} < T_A < +125^\circ\text{C}, \text{shutdown active}, V_{SD} = \text{negative supply voltage } (V_{SS})$ | | 10 | | nA |
| POWER SUPPLY | | | | | | |
| Power Supply Rejection Ratio | PSRR | $V_{SY} = 2.7\text{ V to }5.5\text{ V}$ | 80 | 90 | | dB |
| | | $-40^\circ\text{C} < T_A < +125^\circ\text{C}$ | 75 | | | dB |
| Supply Current Per Amplifier | I_{SY} | $V_{OUT} = V_{SY}/2$ | | 165 | 200 | μA |
| | | $-40^\circ\text{C} < T_A < +125^\circ\text{C}$ | | | 240 | μA |
| Supply Current Shutdown Mode | I_{SD} | All amplifiers shut down, $V_{SD} = V_{SS}$ | | 10 | | nA |
| | | $-40^\circ\text{C} < T_A < +125^\circ\text{C}$ | | | 2 | μA |

| Parameter | Symbol | Test Conditions/Comments | Min | Typ | Max | Unit |
|----------------------------|-----------|--|-----|-------|-----|------------------------|
| DYNAMIC PERFORMANCE | | | | | | |
| Slew Rate | SR | $R_L = 600\ \Omega$, load capacitance (C_L) = 20 pF, $A_v = +1$ | | 1.1 | | V/ μ s |
| | | $R_L = 2\ \text{k}\Omega$, $C_L = 20\ \text{pF}$, $A_v = +1$ | | 1.4 | | V/ μ s |
| Settling Time to 0.1% | t_s | Step = 0.5 V, $R_L = 2\ \text{k}\Omega$, 600 Ω | | 1 | | μ s |
| Gain Bandwidth Product | GBP | $R_L = 1\ \text{M}\Omega$, $C_L = 35\ \text{pF}$, $A_v = +1$ | | 3.6 | | MHz |
| Phase Margin | Φ_M | $R_L = 1\ \text{M}\Omega$, $C_L = 35\ \text{pF}$, $A_v = +1$ | | 49 | | Degrees |
| Turn-On/Turn-Off Time | | $R_L = 600\ \Omega$ | | 1 | | μ s |
| NOISE PERFORMANCE | | | | | | |
| Distortion | THD + N | $A_v = -1$, $R_L = 2\ \text{k}\Omega$, $f = 1\ \text{kHz}$, input voltage (V_{IN}) rms = 0.15 V rms | | 0.009 | | % |
| | | $A_v = -1$, $R_L = 600\ \Omega$, $f = 1\ \text{kHz}$, V_{IN} rms = 0.15 V rms | | 0.01 | | % |
| | | $A_v = +1$, $R_L = 2\ \text{k}\Omega$, $f = 1\ \text{kHz}$, V_{IN} rms = 0.15 V rms | | 0.006 | | % |
| | | $A_v = +1$, $R_L = 600\ \Omega$, $f = 1\ \text{kHz}$, V_{IN} rms = 0.15 V rms | | 0.009 | | % |
| Voltage Noise | e_n p-p | $f = 0.1\ \text{Hz}$ to 10 Hz | | 3.1 | | μ V p-p |
| Voltage Noise Density | e_n | $f = 1\ \text{kHz}$ | | 16 | | nV/ $\sqrt{\text{Hz}}$ |
| | | $f = 10\ \text{kHz}$ | | 13 | | nV/ $\sqrt{\text{Hz}}$ |

ELECTRICAL CHARACTERISTICS—5 V OPERATION

$V_{SY} = 5\ \text{V}$, $V_{CM} = V_{SY}/2$, $T_A = 25^\circ\text{C}$, unless otherwise specified.

Table 3.

| Parameter | Symbol | Test Conditions/Comments | Min | Typ | Max | Unit |
|--------------------------------|--------------------------|---|------|-----|------|------------------------------|
| INPUT CHARACTERISTICS | | | | | | |
| Offset Voltage | V_{OS} | $V_{CM} = -0.3\ \text{V}$ to $+3.9\ \text{V}$ | | 0.5 | 2.5 | mV |
| Dual (ADA469x-2) | | $V_{CM} = -0.1\ \text{V}$ to $+3.9\ \text{V}$; $-40^\circ\text{C} < T_A < +125^\circ\text{C}$ | | | 3.5 | mV |
| Quad (ADA469x-4) | | $V_{CM} = -0.1\ \text{V}$ to $+3.9\ \text{V}$; $-40^\circ\text{C} < T_A < +125^\circ\text{C}$ | | | 4.0 | mV |
| Offset Voltage Drift | $\Delta V_{OS}/\Delta T$ | $-40^\circ\text{C} < T_A < +125^\circ\text{C}$ | | 1 | 4 | $\mu\text{V}/^\circ\text{C}$ |
| Input Bias Current | I_B | $-40^\circ\text{C} < T_A < +125^\circ\text{C}$ | | 0.5 | 5 | pA |
| | | | | | 360 | pA |
| Input Offset Current | I_{OS} | $-40^\circ\text{C} < T_A < +125^\circ\text{C}$ | | 1 | 8 | pA |
| | | | | | 260 | pA |
| Input Voltage Range | | $-40^\circ\text{C} < T_A < +125^\circ\text{C}$ | -0.3 | | +3.9 | V |
| Common-Mode Rejection Ratio | CMRR | $V_{CM} = -0.3\ \text{V}$ to $+3.9\ \text{V}$ | 75 | 98 | | dB |
| | | $V_{CM} = -0.1\ \text{V}$ to $+3.9\ \text{V}$; $-40^\circ\text{C} < T_A < +125^\circ\text{C}$ | 68 | | | dB |
| Large Signal Voltage Gain | A_{VO} | $R_L = 2\ \text{k}\Omega$, $V_{OUT} = 0.5\ \text{V}$ to $4.5\ \text{V}$, $V_{CM} = 0\ \text{V}$ | 95 | 110 | | dB |
| | | $-40^\circ\text{C} < T_A < +85^\circ\text{C}$ | 80 | | | dB |
| | | $-40^\circ\text{C} < T_A < +125^\circ\text{C}$ | 70 | | | dB |
| | | $R_L = 600\ \Omega$, $V_{OUT} = 0.5\ \text{V}$ to $4.5\ \text{V}$, $V_{CM} = 0\ \text{V}$ | 90 | 100 | | dB |
| Input Capacitance | | | | | | |
| Differential Mode | C_{INDM} | | | 2.5 | | pF |
| Common Mode | C_{INCM} | | | 7 | | pF |
| Logic High Voltage (Enabled) | V_{IH} | $-40^\circ\text{C} < T_A < +125^\circ\text{C}$ | 2.0 | | | V |
| Logic Low Voltage (Power-Down) | V_{IL} | $-40^\circ\text{C} < T_A < +125^\circ\text{C}$ | | | 0.8 | V |
| Logic Input Current (Per Pin) | I_{IN} | $-40^\circ\text{C} < T_A < +125^\circ\text{C}$, $0\ \text{V} \leq V_{SD} \leq 2.7\ \text{V}$ | | | 1 | μA |

| Parameter | Symbol | Test Conditions/Comments | Min | Typ | Max | Unit |
|-------------------------------|-----------|---|------|----------|-----|------------------------|
| OUTPUT CHARACTERISTICS | | | | | | |
| Output Voltage High | V_{OH} | $R_L = 2\text{ k}\Omega$ to V_{CM} | 4.95 | 4.97 | | V |
| | | $-40^\circ\text{C} \leq T_A \leq +125^\circ\text{C}$ | 4.90 | | | V |
| | | $R_L = 600\ \Omega$ to V_{CM} | 4.85 | 4.88 | | V |
| | | $-40^\circ\text{C} \leq T_A \leq +125^\circ\text{C}$ | 4.80 | | | V |
| Output Voltage Low | V_{OL} | $R_L = 2\text{ k}\Omega$ to V_{CM} | | 30 | 40 | mV |
| | | $-40^\circ\text{C} \leq T_A \leq +125^\circ\text{C}$ | | | 55 | mV |
| | | $R_L = 600\ \Omega$ to V_{CM} | | 100 | 128 | mV |
| | | $-40^\circ\text{C} \leq T_A \leq +125^\circ\text{C}$ | | | 173 | mV |
| Short-Circuit Limit | I_{SC} | $V_{OUT} = V_{SY}$ or GND | | ± 55 | | mA |
| Closed-Loop Output Impedance | Z_{OUT} | ADA4691-2, $f = 1\text{ MHz}$, $A_V = -100$ | | 364 | | Ω |
| | | ADA4691-2, $f = 1\text{ MHz}$, $A_V = -100$ | | 246 | | Ω |
| Output Pin Leakage Current | | $-40^\circ\text{C} < T_A < +125^\circ\text{C}$, shutdown active, $V_{SD} = V_{SS}$ | | 10 | | nA |
| POWER SUPPLY | | | | | | |
| Power Supply Rejection Ratio | PSRR | $V_{SY} = 2.7\text{ V}$ to 5.5 V | 80 | 90 | | dB |
| | | $-40^\circ\text{C} \leq T_A \leq +125^\circ\text{C}$ | 75 | | | dB |
| Supply Current Per Amplifier | I_{SY} | $V_{OUT} = V_{SY}/2$ | | 180 | 225 | μA |
| Supply Current Shutdown Mode | I_{SD} | $-40^\circ\text{C} \leq T_A \leq +125^\circ\text{C}$ | | | 275 | μA |
| | | All amplifiers shut down, $V_{SD} = V_{SS}$ | | 10 | | nA |
| | | $-40^\circ\text{C} \leq T_A \leq +125^\circ\text{C}$ | | | 2 | μA |
| DYNAMIC PERFORMANCE | | | | | | |
| Slew Rate | SR | $R_L = 2\text{ k}\Omega$, $600\ \Omega$, $C_L = 20\text{ pF}$, $A_V = +1$ | | 1.3 | | V/ μs |
| Settling Time to 0.1% | t_s | $V_{IN} = 2\text{ V}$ step, $R_L = 2\text{ k}\Omega$ or $600\ \Omega$ | | 1.5 | | μs |
| Gain Bandwidth Product | GBP | $R_L = 1\text{ M}\Omega$, $C_L = 35\text{ pF}$, $A_V = +1$ | | 3.6 | | MHz |
| Phase Margin | Φ_M | $R_L = 1\text{ M}\Omega$, $C_L = 35\text{ pF}$, $A_V = +1$ | | 52 | | Degrees |
| Turn-On/Turn-Off Time | | $R_L = 600\ \Omega$ | | 1 | | μs |
| NOISE PERFORMANCE | | | | | | |
| Distortion | THD + N | $A_V = -1$, $R_L = 2\text{ k}\Omega$, $f = 1\text{ kHz}$, $V_{IN\text{ rms}} = 0.8\text{ V rms}$ | | 0.006 | | % |
| | | $A_V = -1$, $R_L = 600\ \Omega$, $f = 1\text{ kHz}$, $V_{IN\text{ rms}} = 0.8\text{ V rms}$ | | 0.008 | | % |
| | | $A_V = +1$, $R_L = 2\text{ k}\Omega$, $f = 1\text{ kHz}$, $V_{IN\text{ rms}} = 0.8\text{ V rms}$ | | 0.001 | | % |
| | | $A_V = +1$, $R_L = 600\ \Omega$, $f = 1\text{ kHz}$, $V_{IN\text{ rms}} = 0.8\text{ V rms}$ | | 0.003 | | % |
| Voltage Noise | e_n p-p | $f = 0.1\text{ Hz}$ to 10 Hz | | 3.2 | | $\mu\text{V p-p}$ |
| Voltage Noise Density | e_n | $f = 1\text{ kHz}$ | | 16 | | nV/ $\sqrt{\text{Hz}}$ |
| | | $f = 10\text{ kHz}$ | | 13 | | nV/ $\sqrt{\text{Hz}}$ |

ABSOLUTE MAXIMUM RATINGS

Table 4.

| Parameter | Rating |
|---|--|
| Supply Voltage | 6 V |
| Input Voltage | $V_{SS} - 0.3 \text{ V}$ to $V_{DD} + 0.3 \text{ V}$ |
| Input Current ¹ | $\pm 10 \text{ mA}$ |
| Shutdown Pin Rise/Fall Times | 50 μs maximum |
| Differential Input Voltage ² | $\pm V_{SY}$ |
| Output Short-Circuit Duration to GND | Indefinite |
| Temperature | |
| Storage Temperature Range | -65°C to $+150^\circ\text{C}$ |
| Operating Temperature Range | -40°C to $+125^\circ\text{C}$ |
| Junction Temperature Range | -65°C to $+150^\circ\text{C}$ |
| Lead Temperature (Soldering, 60 sec) | 300°C |

¹ Input pins have clamp diodes to the supply pins. Limit the input current to 10 mA or less whenever the input signal exceeds the power supply rail by 0.3 V.

² Differential input voltage is limited to 6 V or the supply voltage, whichever is less.

Stresses at or above those listed under Absolute Maximum Ratings may cause permanent damage to the product. This is a stress rating only; functional operation of the product at these or any other conditions above those indicated in the operational section of this specification is not implied. Operation beyond the maximum operating conditions for extended periods may affect product reliability.

THERMAL RESISTANCE

θ_{JA} is specified for the worst-case conditions, that is, a device soldered in a circuit board for surface-mount packages and measured using a standard 4-layer board, unless otherwise specified.

Table 5. Thermal Resistance

| Package Type | θ_{JA} | θ_{JC} | Unit |
|--------------------------|---------------|------------------|---------------------------|
| 8-Lead SOIC_N (R-8) | 120 | 45 | $^\circ\text{C}/\text{W}$ |
| 8-Lead LFCSP (CP-8-6) | 125 | 40 | $^\circ\text{C}/\text{W}$ |
| 9-Ball WLCSP (CB-9-3) | 77 | N/A ¹ | $^\circ\text{C}/\text{W}$ |
| 10-Lead LFCSP (CP-10-11) | 115 | 40 | $^\circ\text{C}/\text{W}$ |
| 16-Lead LFCSP (CP-16-22) | 75 | 12 | $^\circ\text{C}/\text{W}$ |
| 14-Lead TSSOP (RU-14) | 112 | 35 | $^\circ\text{C}/\text{W}$ |

¹ N/A = not applicable.

ESD CAUTION



ESD (electrostatic discharge) sensitive device. Charged devices and circuit boards can discharge without detection. Although this product features patented or proprietary protection circuitry, damage may occur on devices subjected to high energy ESD. Therefore, proper ESD precautions should be taken to avoid performance degradation or loss of functionality.

PIN CONFIGURATIONS

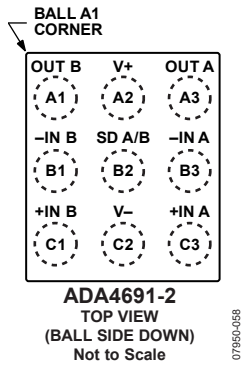

Figure 3. 9-Ball Wafer Level Chip Scale WLCSP (CB-9-3)

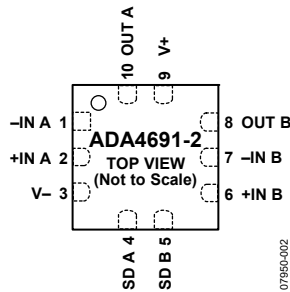
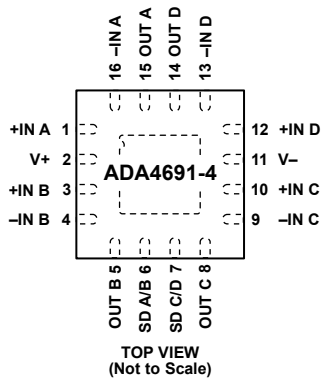

Figure 4. 10-Lead, 2 mm x 2 mm LFCSP (CP-10-11)



NOTES
1. IT IS RECOMMENDED THAT THE EXPOSED PAD BE CONNECTED TO V-.

Figure 5. 16-Lead, 3 mm x 3 mm LFCSP (CP-16-22)

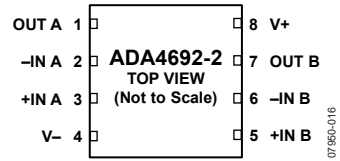

Figure 6. 8-Lead, 2 mm x 2 mm LFCSP (CP-8-6)

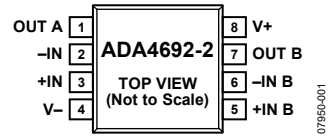

Figure 7. 8-Lead SOIC_N (R-8)

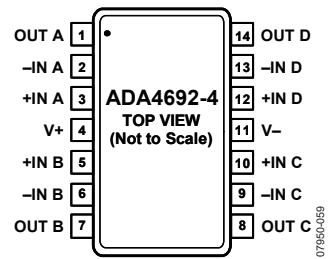

Figure 8. 14-Lead TSSOP (RU-14)

TYPICAL PERFORMANCE CHARACTERISTICS

T_A = 25°C, unless otherwise noted.

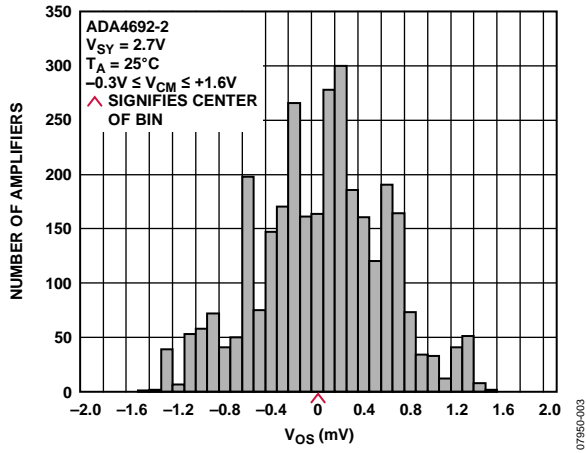

Figure 9. Input Offset Voltage Distribution

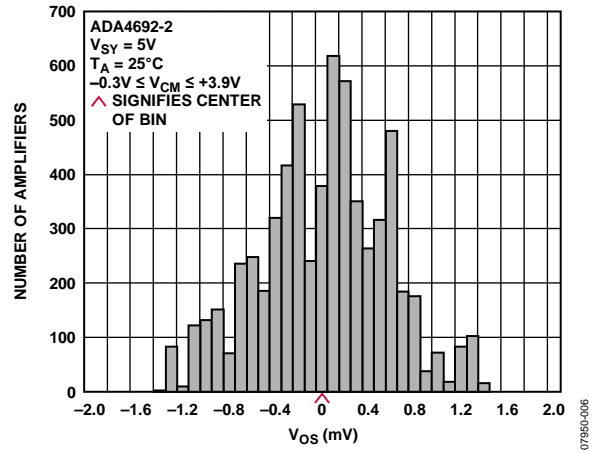

Figure 12. Input Offset Voltage Distribution

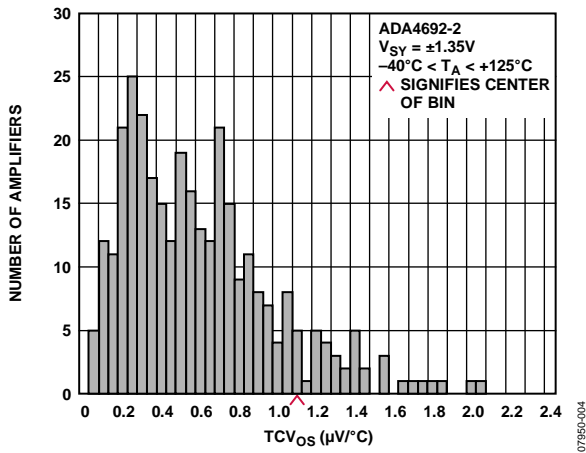

Figure 10. Input Offset Voltage Drift Distribution

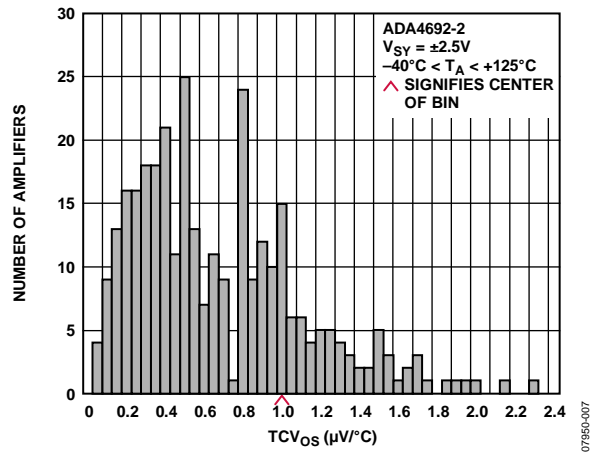

Figure 13. Input Offset Voltage Drift Distribution

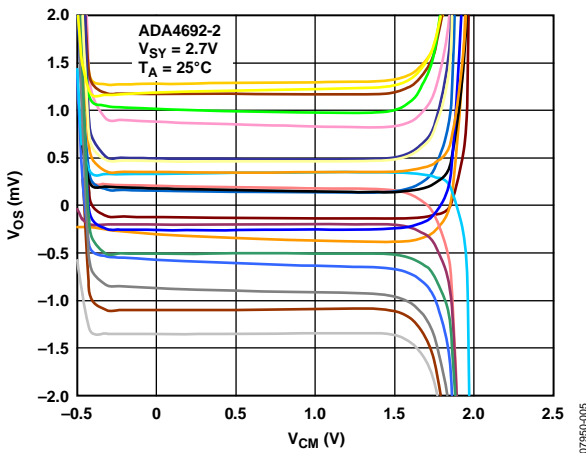

Figure 11. Input Offset Voltage vs. Common-Mode Voltage

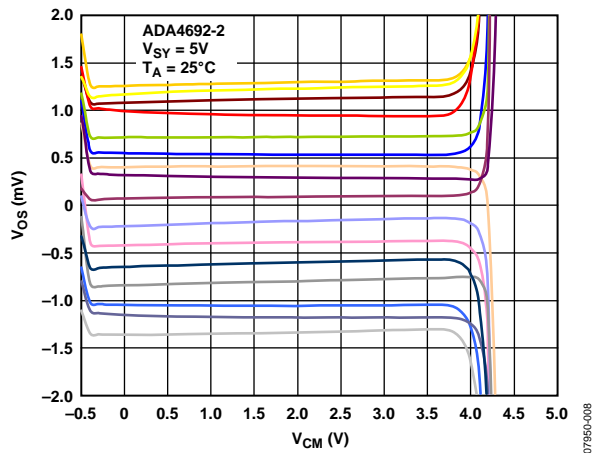

Figure 14. Input Offset Voltage vs. Common-Mode Voltage

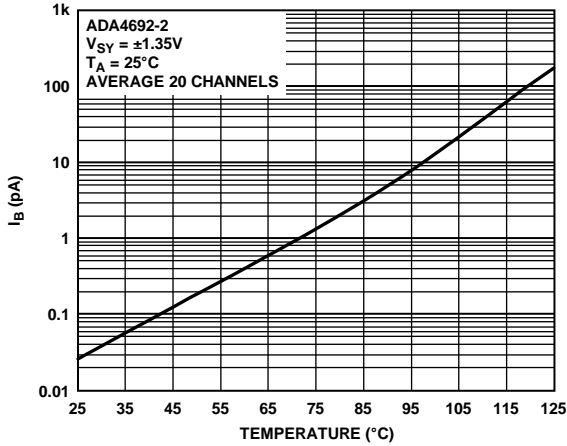

Figure 15. Input Bias Current vs. Temperature

07950-009

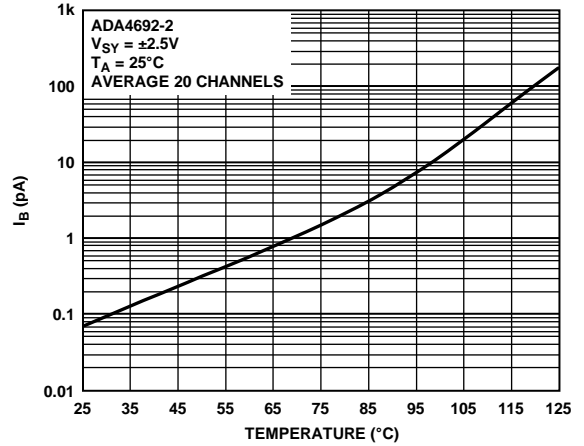

Figure 18. Input Bias Current vs. Temperature

07950-012

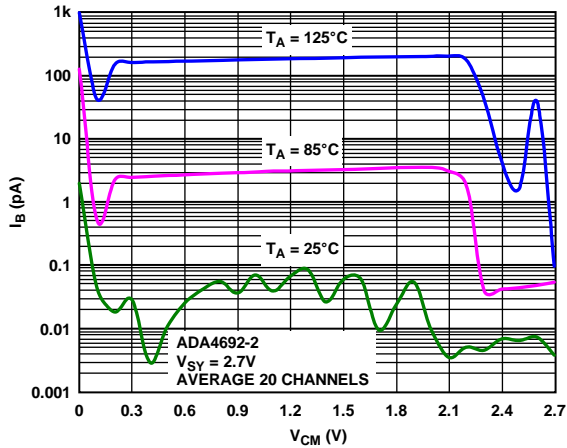

Figure 16. Input Bias Current vs. Common-Mode Voltage

07950-010

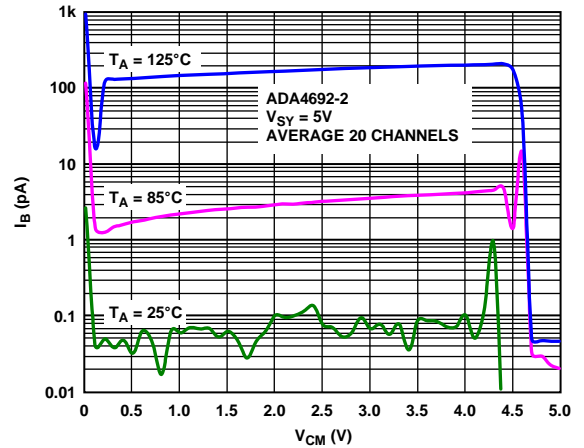

Figure 19. Input Bias Current vs. Common-Mode Voltage

07950-013

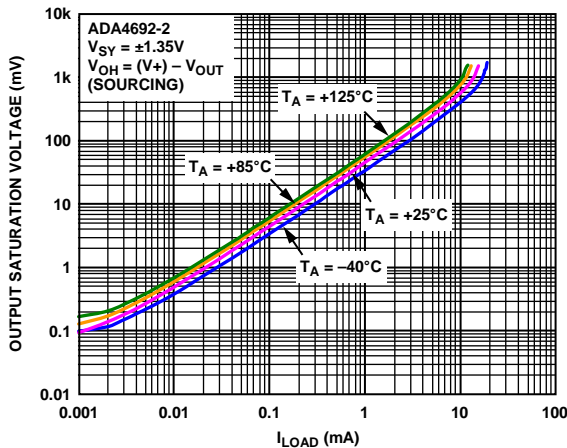

Figure 17. Output Voltage (V_{OH}) to Supply Rail vs. Load Current

07950-011

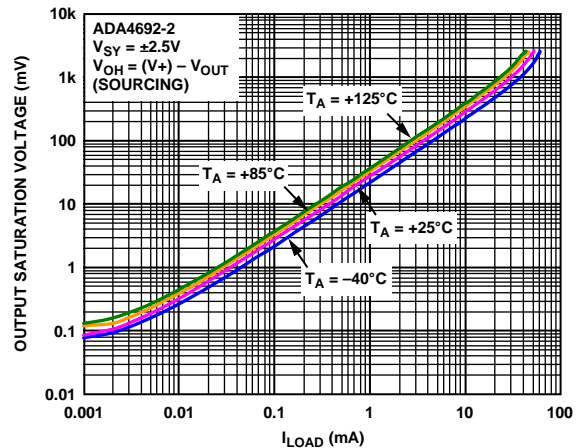

Figure 20. Output Voltage (V_{OH}) to Supply Rail vs. Load Current

07950-014

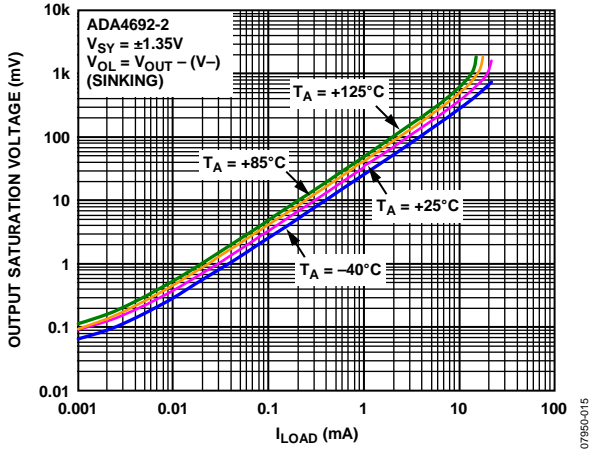

Figure 21. Output Voltage (V_{OL}) to Supply Rail vs. Load Current

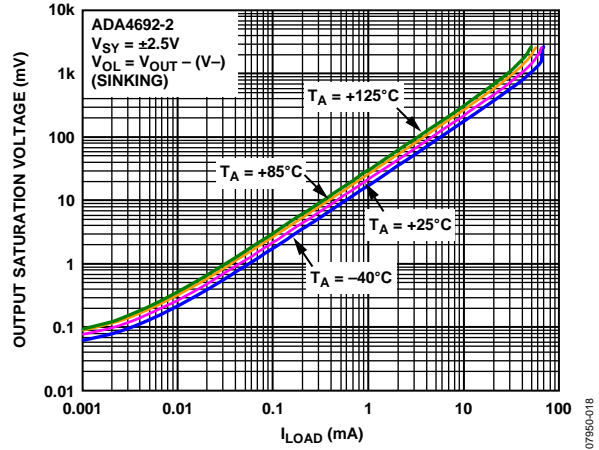

Figure 24. Output Voltage (V_{OL}) to Supply Rail vs. Load Current

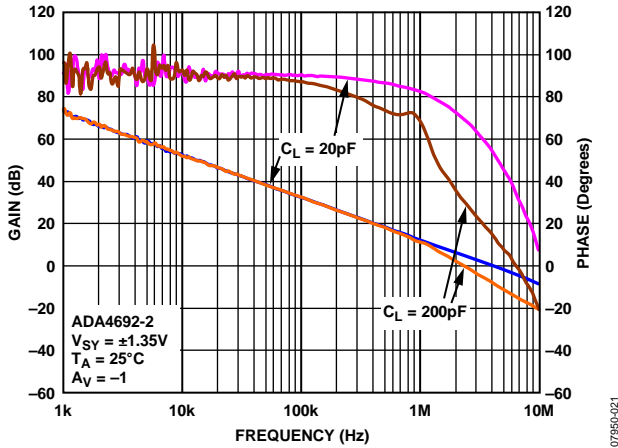

Figure 22. Open-Loop Gain and Phase vs. Frequency

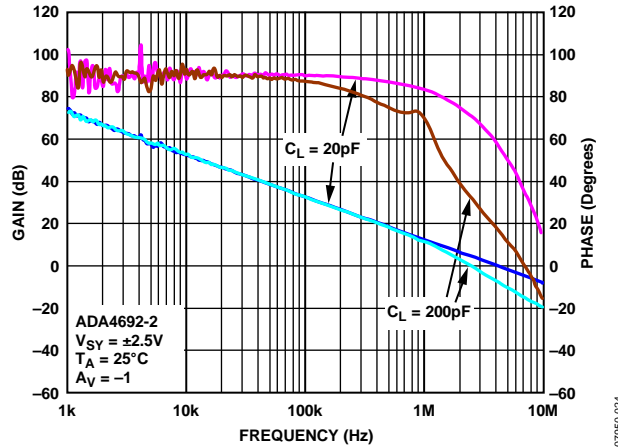

Figure 25. Open-Loop Gain and Phase vs. Frequency

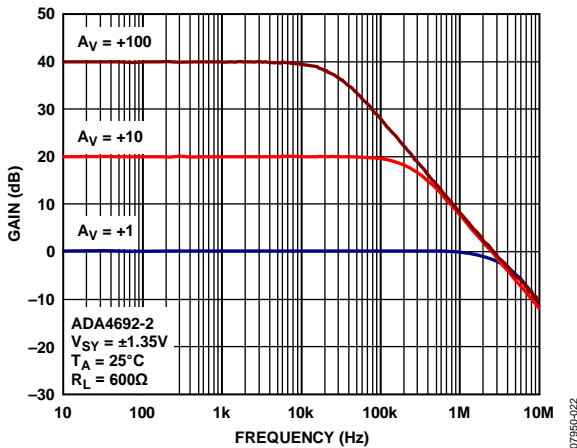

Figure 23. Closed-Loop Gain vs. Frequency

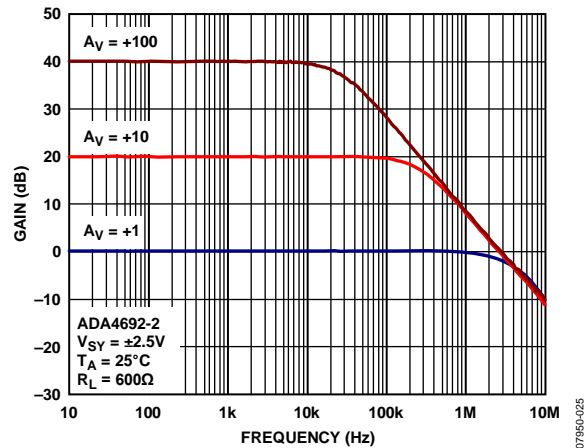

Figure 26. Closed-Loop Gain vs. Frequency

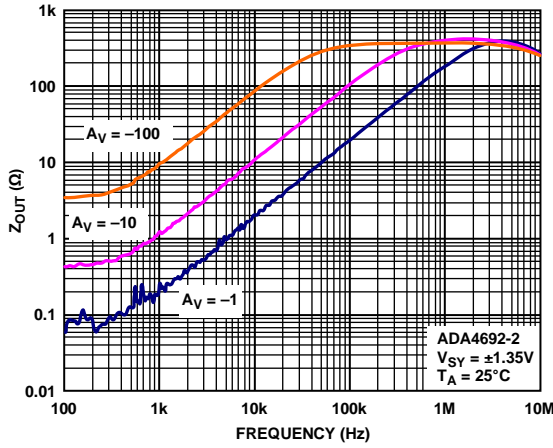

Figure 27. Output Impedance vs. Frequency

07950-023

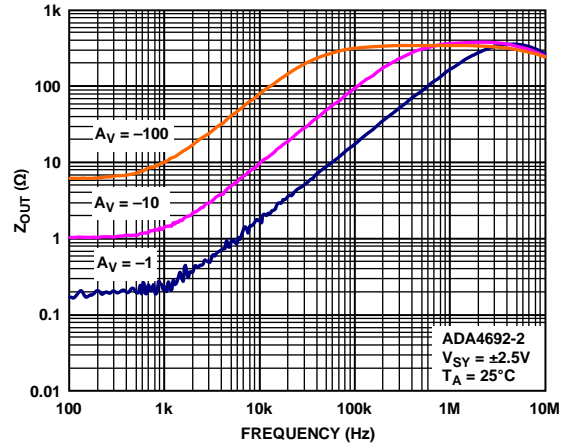

Figure 30. Output Impedance vs. Frequency

07950-026

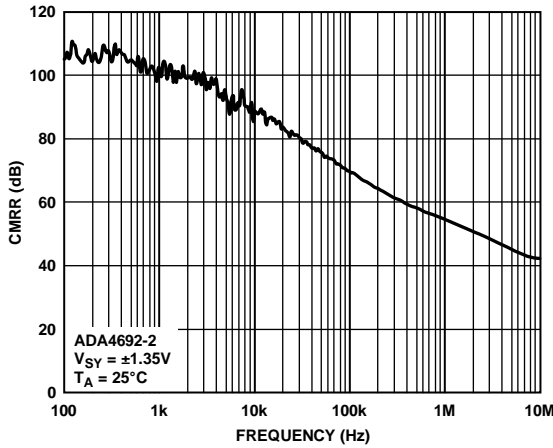

Figure 28. CMRR vs. Frequency

07950-027

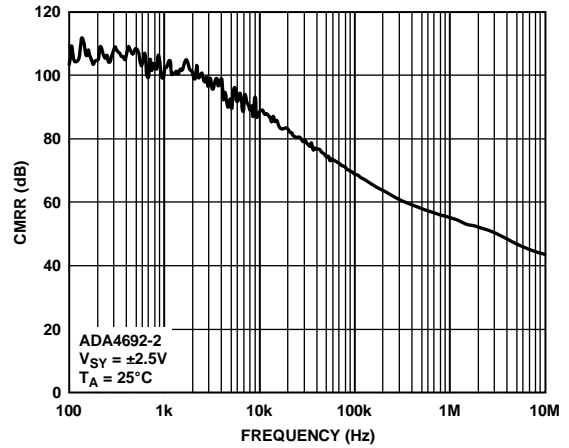

Figure 31. CMRR vs. Frequency

07950-030

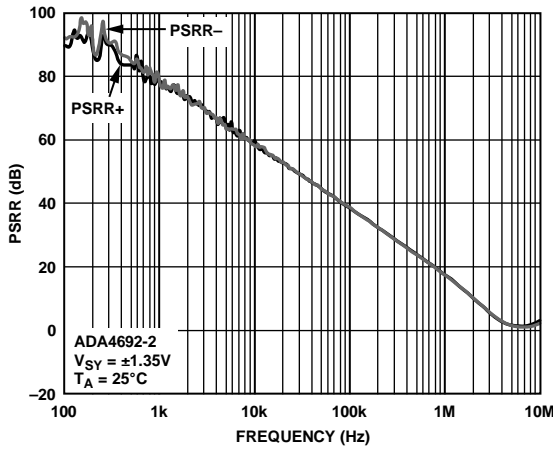

Figure 29. PSRR vs. Frequency

07950-028

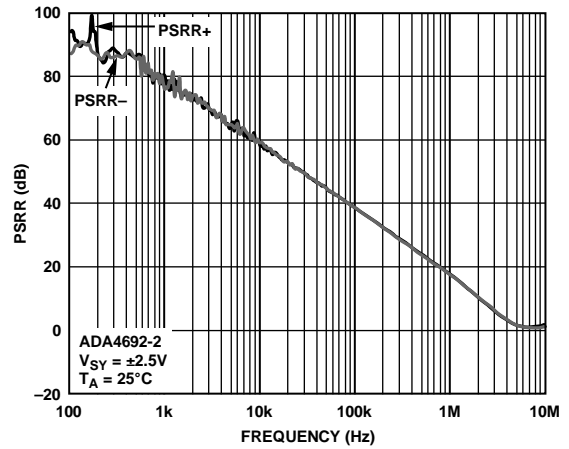

Figure 32. PSRR vs. Frequency

07950-031

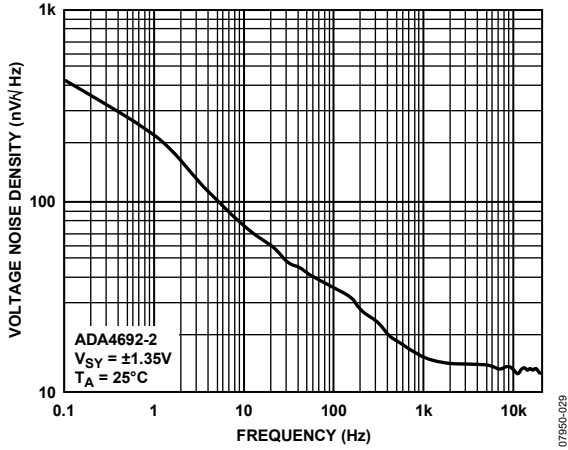

Figure 33. Voltage Noise Density vs. Frequency

07950-029

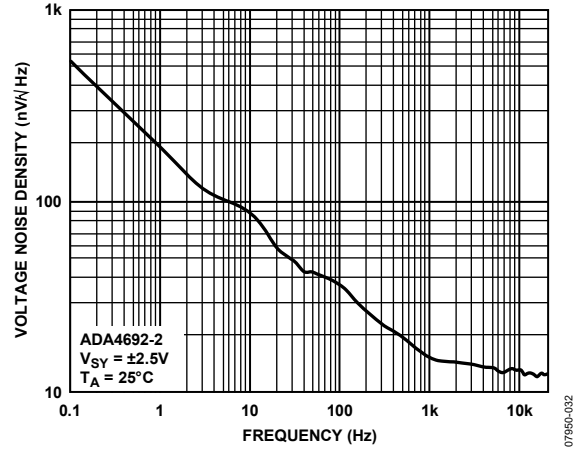

Figure 36. Voltage Noise Density vs. Frequency

07950-032

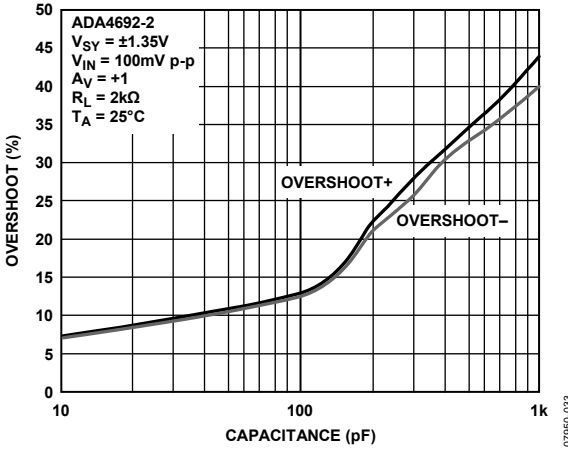

Figure 34. Small Signal Overshoot vs. Load Capacitance

07950-033

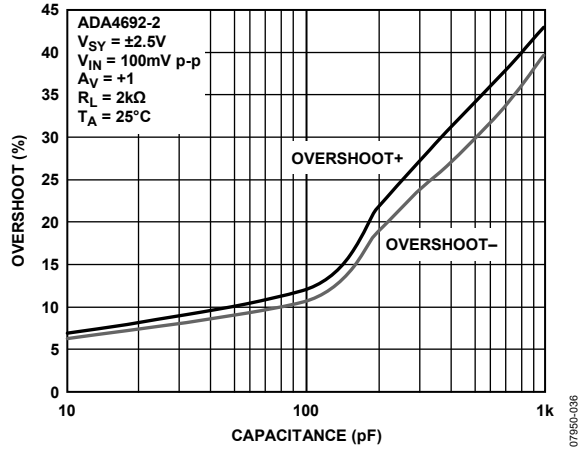

Figure 37. Small Signal Overshoot vs. Load Capacitance

07950-036

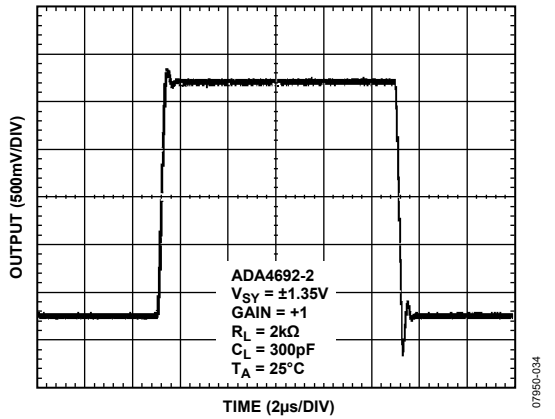

Figure 35. Large Signal Transient Response

07950-034

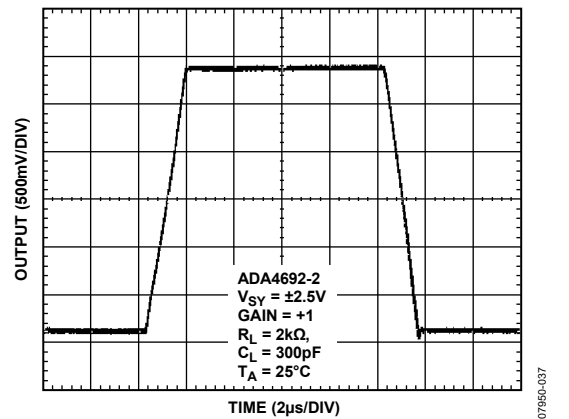

Figure 38. Large Signal Transient Response

07950-037

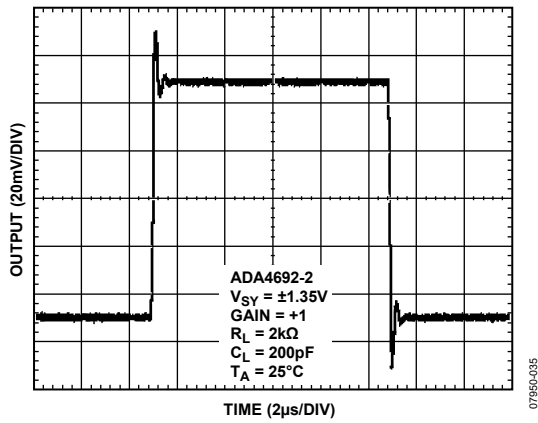

Figure 39. Small Signal Transient Response

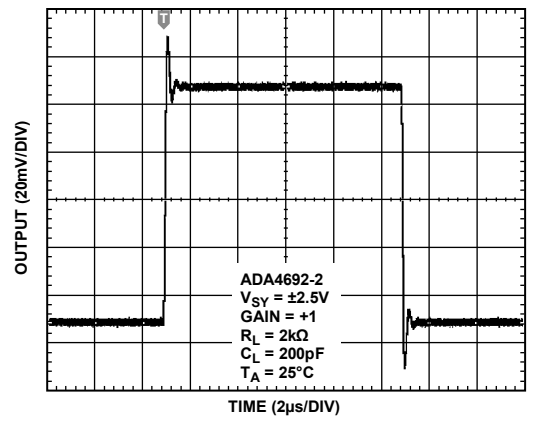

Figure 42. Small Signal Transient Response

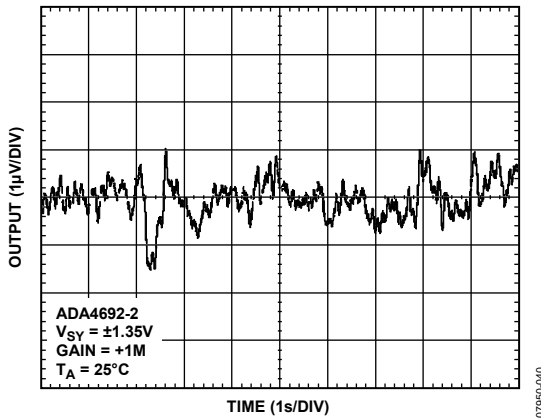

Figure 40. 0.1 Hz to 10 Hz Noise

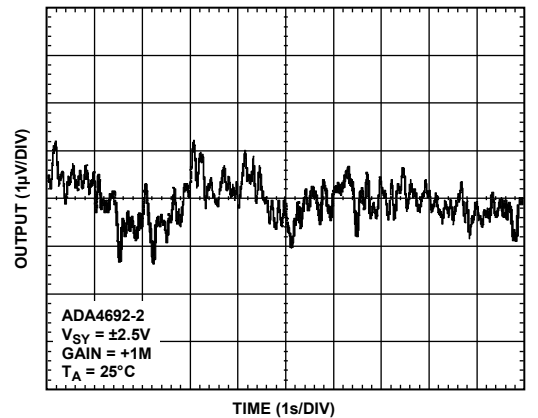

Figure 43. 0.1 Hz to 10 Hz Noise

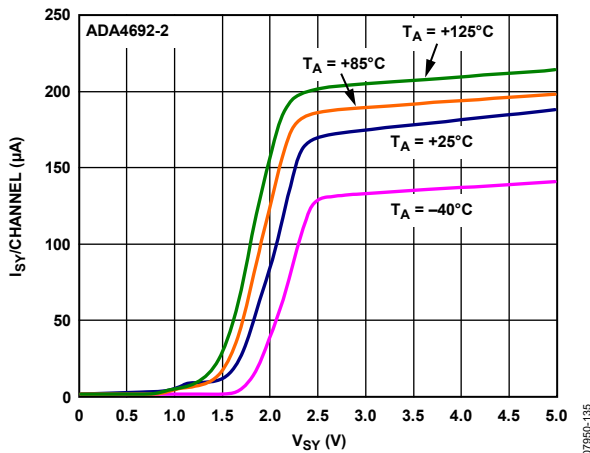

Figure 41. Supply Current per Amplifier vs. Supply Voltage

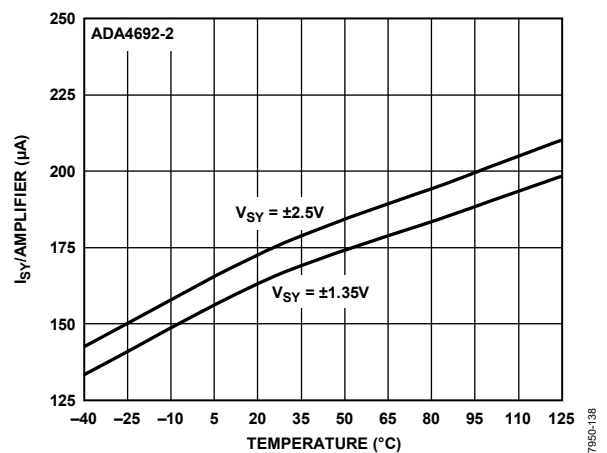

Figure 44. Supply Current per Channel vs. Temperature

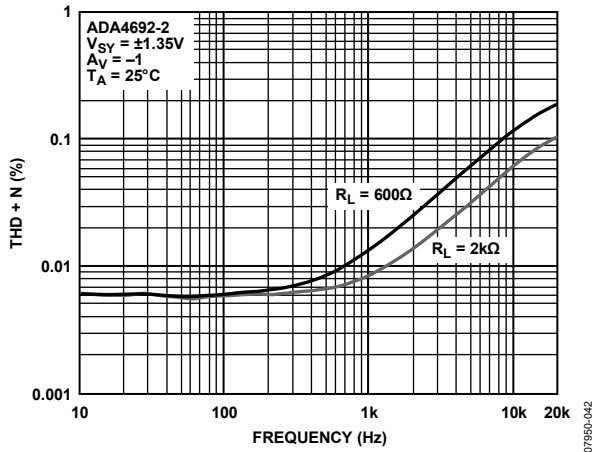

Figure 45. THD + Noise vs. Frequency

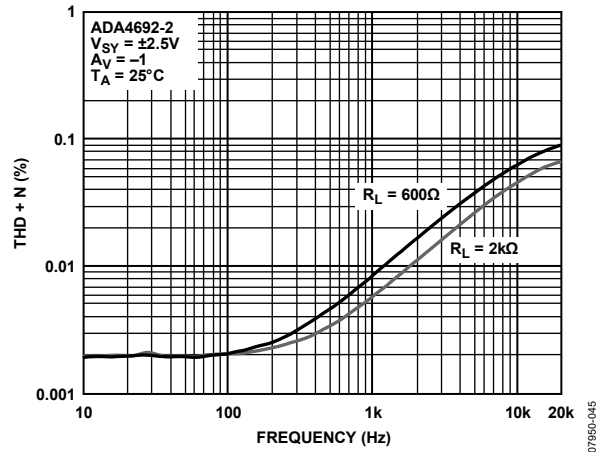

Figure 48. THD + Noise vs. Frequency

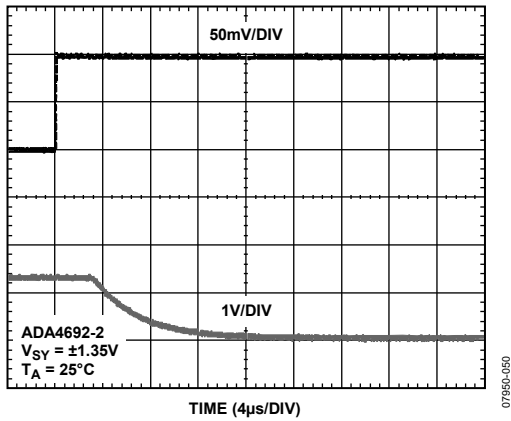

Figure 46. Positive Overload Recovery

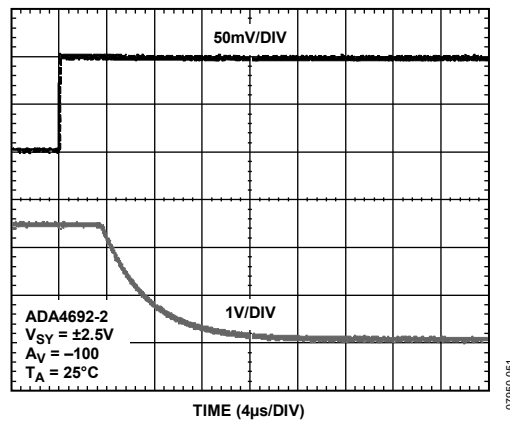

Figure 49. Positive Overload Recovery

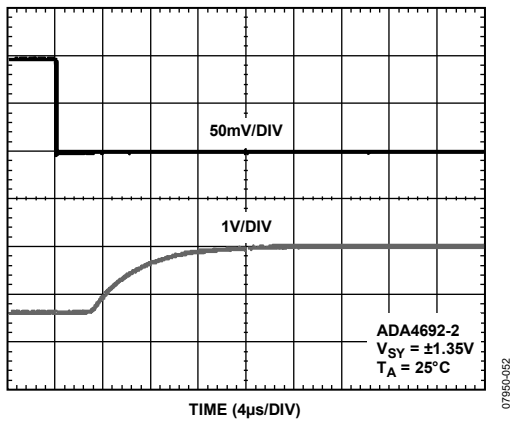

Figure 47. Negative Overload Recovery

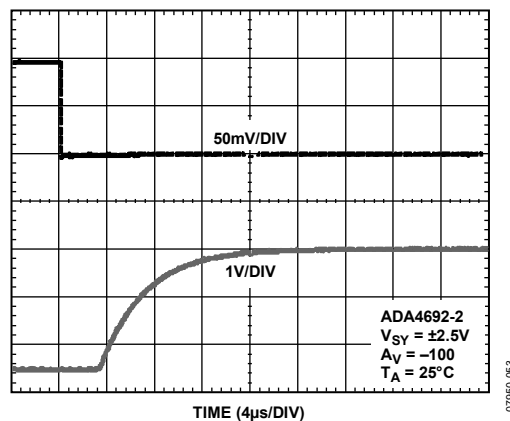

Figure 50. Negative Overload Recovery

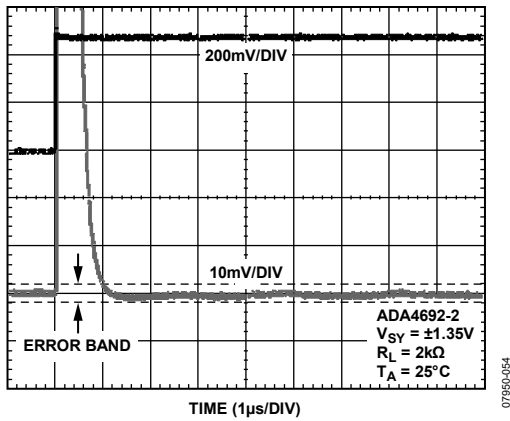

Figure 51. Positive Settling Time to 0.1%

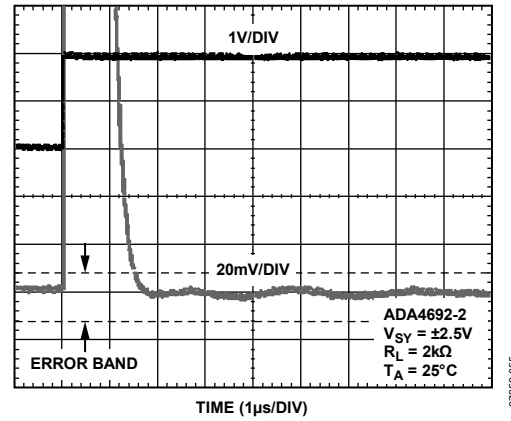

Figure 54. Positive Settling Time to 0.1%

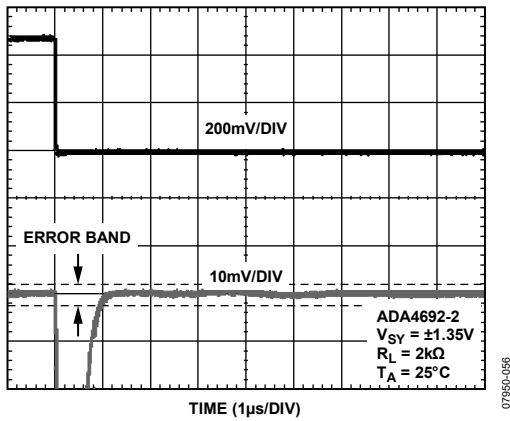

Figure 52. Negative Settling Time to 0.1%

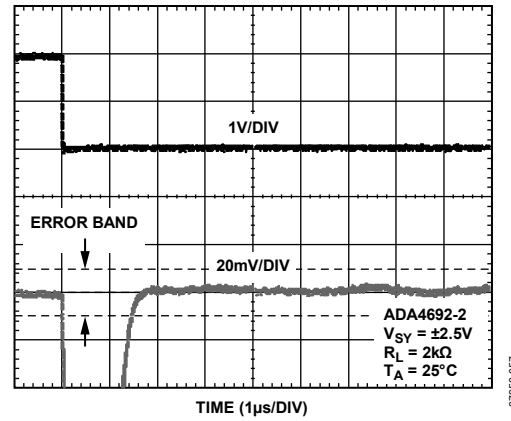

Figure 55. Negative Settling Time to 0.1%

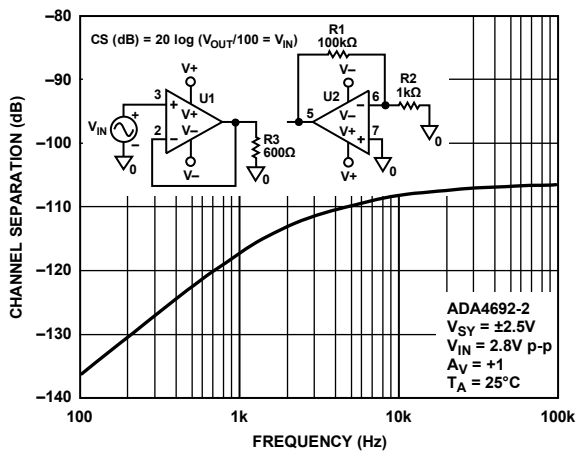

Figure 53. Channel Separation (CS) vs. Frequency

SHUTDOWN OPERATION

INPUT PIN CHARACTERISTICS

The ADA4691-2 has a classic CMOS logic inverter input for each shutdown pin, as shown in Figure 56.

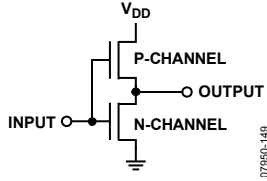

Figure 56. CMOS Inverter

With slowly changing inputs, the top transistor and bottom transistor may be slightly on at the same time, increasing the supply current. This can be avoided by driving the input with a digital logic output having fast rise and fall times. Figure 57 through Figure 59 show the supply current for both sections switching simultaneously with rise times of 1 μ s, 10 μ s, and 1 ms. Clearly, the rise and fall times should be faster than 10 μ s. Using an RC time constant to enable/disable shutdown is not recommended.

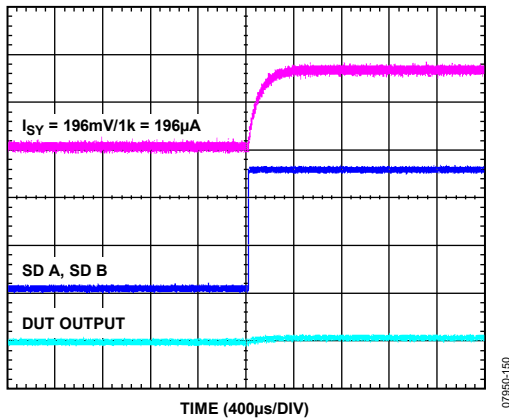

Figure 57. Shutdown Pin Rise Time = 1 μ s

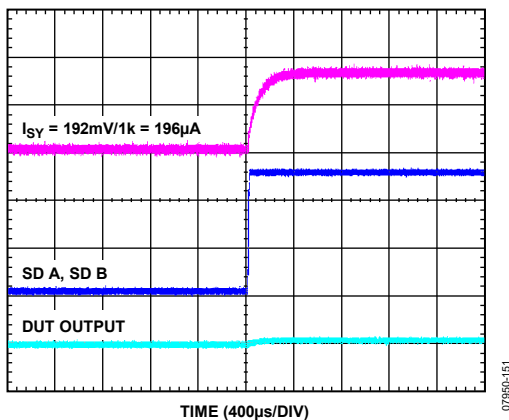

Figure 58. Shutdown Pin Rise Time = 10 μ s

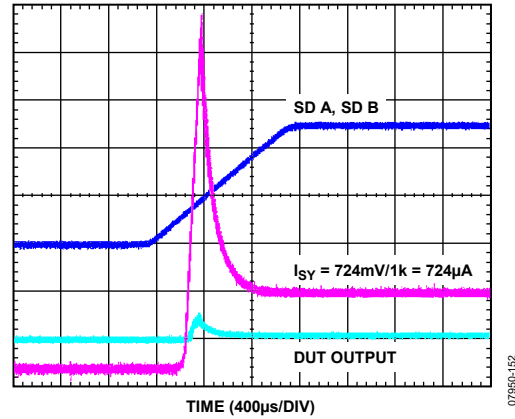

Figure 59. Shutdown Pin Rise Time = 1 ms

INPUT THRESHOLD

The input threshold is approximately 1.2 V above the V- pin when operating on ground and 5 V and 0.9 V when operating on 2.7 V (see Figure 60 and Figure 61). The threshold is relatively stable over temperature. For operation on split supplies, the logic swing may have to be level shifted.

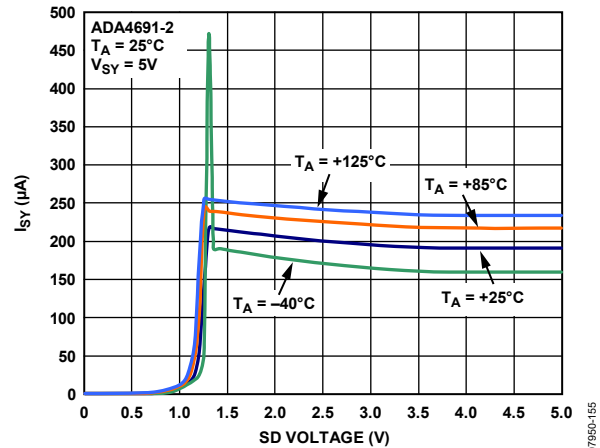

Figure 60. Supply Current vs. Temperature, $V_{SY} = 5V$

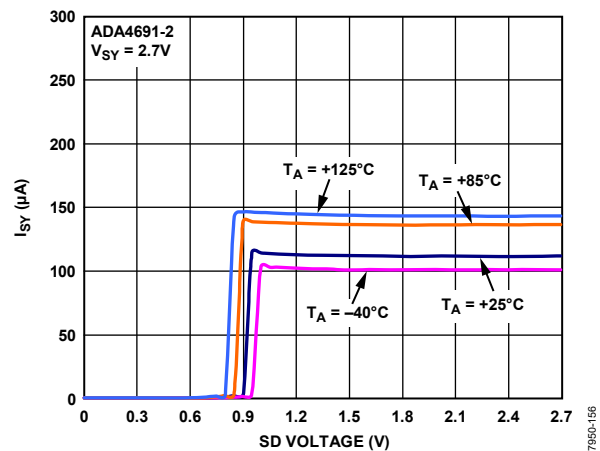
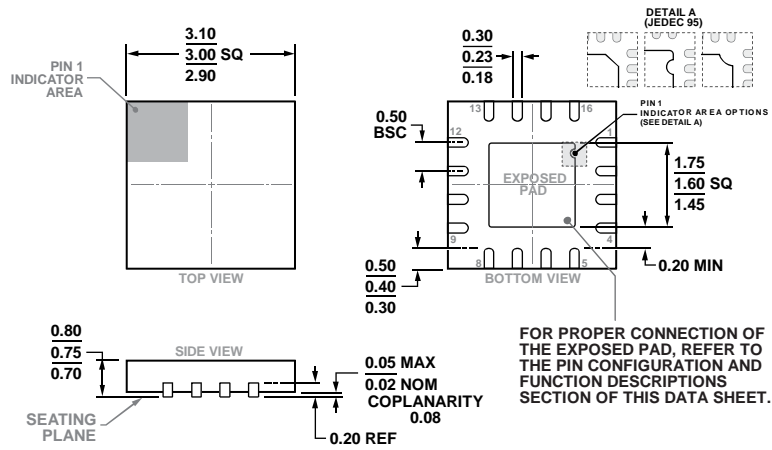

Figure 61. Supply Current vs. Temperature, $V_{SY} = 2.7V$

OUTLINE DIMENSIONS



COMPLIANT TO JEDEC STANDARDS MO-220-WEED-6

Figure 62. 16-Lead Lead Frame Chip Scale Package [LFCSP]
3 mm x 3 mm Body and 0.75 mm Package Height
(CP-16-22)

Dimensions shown in millimeters

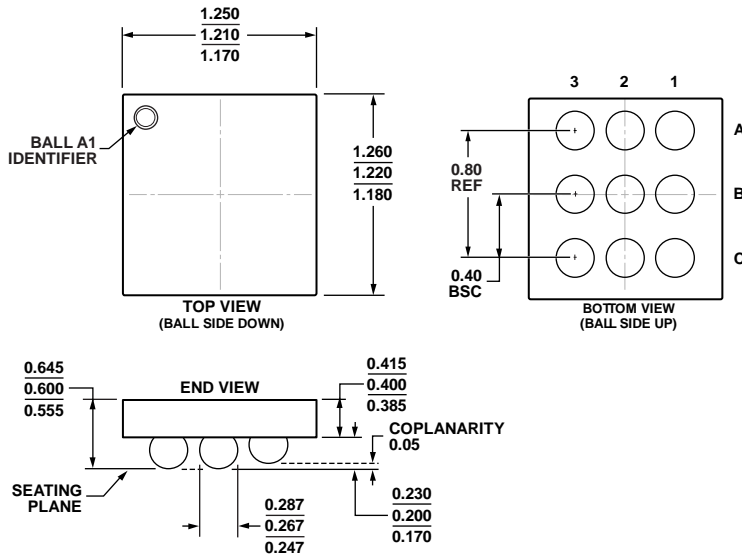

Figure 63. 9-Ball Wafer Level Chip Scale Package [WLCSF]
(CB-9-3)

Dimensions shown in millimeters

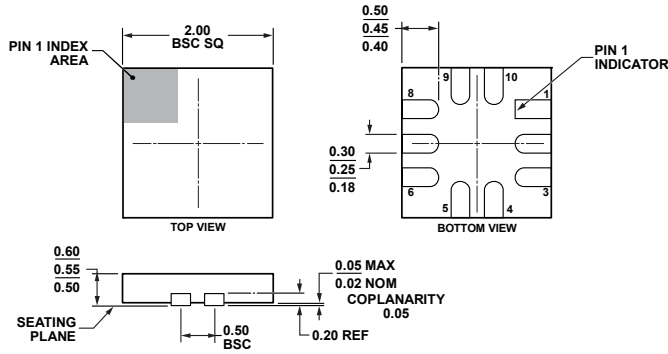

Figure 64. 10-Lead Lead Frame Chip Scale Package [LFCSP]
 2 mm × 2 mm Body and 0.55 mm Package Height
 (CP-10-11)
 Dimensions shown in millimeters

081308-D

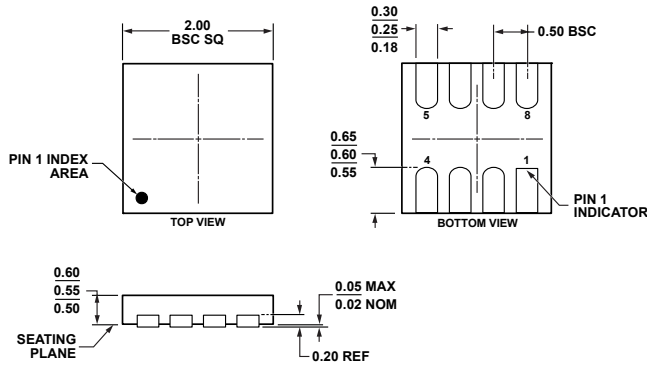
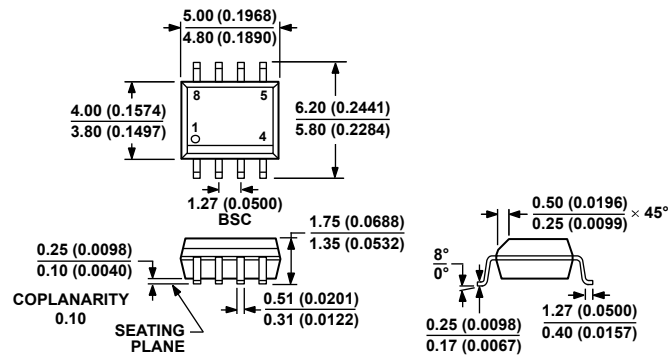

Figure 65. 8-Lead Lead Frame Chip Scale Package [LFCSP]
 2 mm × 2 mm Body and 0.55 mm Package Height
 (CP-8-6)
 Dimensions shown in millimeters

082409-A



COMPLIANT TO JEDEC STANDARDS MS-012-AA
 CONTROLLING DIMENSIONS ARE IN MILLIMETERS; INCH DIMENSIONS
 (IN PARENTHESES) ARE ROUNDED-OFF MILLIMETER EQUIVALENTS FOR
 REFERENCE ONLY AND ARE NOT APPROPRIATE FOR USE IN DESIGN.

Figure 66. 8-Lead Standard Small Outline Package [SOIC_N]
 Narrow Body
 (R-8)
 Dimensions shown in millimeters and (inches)

012407-A

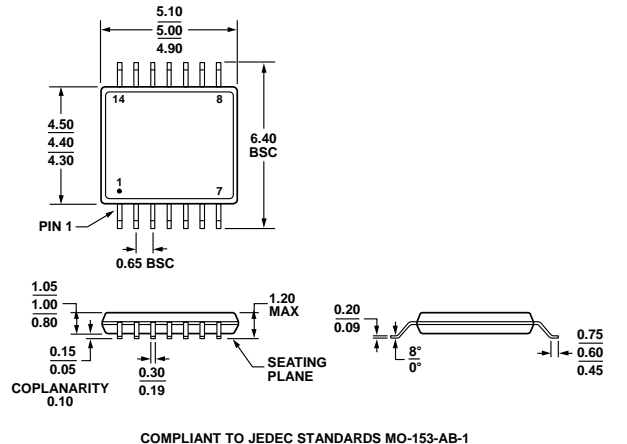

COMPLIANT TO JEDEC STANDARDS MO-153-AB-1
 Figure 67. 14-Lead Thin Shrink Small Outline Package [TSSOP]
 (RU-14)
 Dimensions shown in millimeters

ORDERING GUIDE

| Model ¹ | Temperature Range | Package Description | Package Option | Marking Code |
|--------------------|-------------------|---------------------|----------------|--------------|
| ADA4691-2ACBZ-R7 | -40°C to +125°C | 9-Ball WLCSP | CB-9-3 | A2C |
| ADA4691-2ACPZ-R7 | -40°C to +125°C | 10-Lead LFCSP | CP-10-11 | A2 |
| ADA4691-4ACPZ-R2 | -40°C to +125°C | 16-Lead LFCSP | CP-16-22 | A2P |
| ADA4691-4ACPZ-R7 | -40°C to +125°C | 16-Lead LFCSP | CP-16-22 | A2P |
| ADA4691-4ACPZ-RL | -40°C to +125°C | 16-Lead LFCSP | CP-16-22 | A2P |
| ADA4692-2ACPZ-R7 | -40°C to +125°C | 8-Lead LFCSP | CP-8-6 | A3 |
| ADA4692-2ARZ | -40°C to +125°C | 8-Lead SOIC_N | R-8 | |
| ADA4692-2ARZ-R7 | -40°C to +125°C | 8-Lead SOIC_N | R-8 | |
| ADA4692-2ARZ-RL | -40°C to +125°C | 8-Lead SOIC_N | R-8 | |
| ADA4692-4ARUZ | -40°C to +125°C | 14-Lead TSSOP | RU-14 | |
| ADA4692-4ARUZ-RL | -40°C to +125°C | 14-Lead TSSOP | RU-14 | |

¹ Z = RoHS Compliant Part.