



FEATURES

- Supports GR-1244 Stratum 3 stability in holdover mode
- Supports smooth reference switchover with virtually no disturbance on output phase
- Supports Telcordia GR-253 jitter generation, transfer, and tolerance for SONET/SDH up to OC-192 systems
- Supports ITU-T G.8262 synchronous Ethernet slave clocks
- Supports ITU-T G.823, G.824, G.825, and G.8261
- Auto/manual holdover and reference switchover
- 4 reference inputs (single-ended or differential)
- Input reference frequencies: 2 kHz to 1250 MHz
- Reference validation and frequency monitoring (1 ppm)
- Programmable input reference switchover priority
- 20-bit programmable input reference divider
- 6 pairs of clock output pins with each pair configurable as a single differential LVDS/HSTL output or as 2 single-ended CMOS outputs
- Output frequencies: 352 Hz to 1250 MHz
- Programmable 17-bit integer and 23-bit fractional feedback divider in digital PLL
- Programmable digital loop filter covering loop bandwidths from 0.1 Hz to 5 kHz (2 kHz maximum for <0.1 dB of peaking)
- Low noise system clock multiplier
- Frame sync support
- Adaptive clocking
- Optional crystal resonator for system clock input
- On-chip EEPROM to store multiple power-up profiles

- Pin program function for easy frequency translation configuration
- Software controlled power-down
- 64-lead, 9 mm × 9 mm, LFCSP package

APPLICATIONS

- Network synchronization, including synchronous Ethernet and SDH to OTN mapping/demapping
- Cleanup of reference clock jitter
- SONET/SDH/OTN clocks up to 100 Gbps, including FEC
- Stratum 3 holdover, jitter cleanup, and phase transient control
- Wireless base station controllers
- Cable infrastructure
- Data communications

GENERAL DESCRIPTION

The AD9558 is a low loop bandwidth clock multiplier that provides jitter cleanup and synchronization for many systems, including synchronous optical networks (OTN/SONET/SDH). The AD9558 generates an output clock synchronized to up to four external input references. The digital phase-locked loop (PLL) allows reduction of input time jitter or phase noise associated with the external references. The digitally controlled loop and holdover circuitry of the AD9558 continuously generates a low jitter output clock even when all reference inputs have failed.

The AD9558 operates over an industrial temperature range of -40°C to +85°C. If a smaller package is required, refer to the AD9557 for the two-input/two-output version of the same device.

FUNCTIONAL BLOCK DIAGRAM

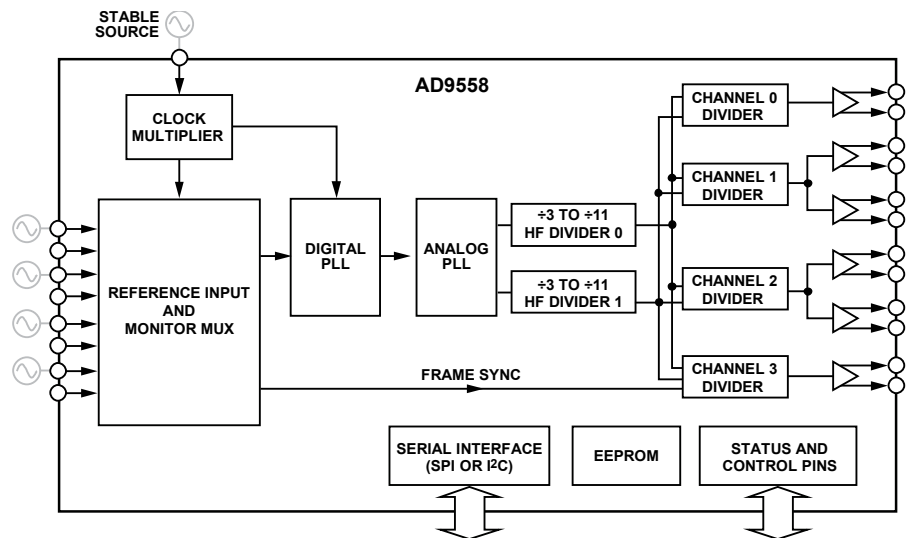

Figure 1.

Rev. C

[Document Feedback](#)

Information furnished by Analog Devices is believed to be accurate and reliable. However, no responsibility is assumed by Analog Devices for its use, nor for any infringements of patents or other rights of third parties that may result from its use. Specifications subject to change without notice. No license is granted by implication or otherwise under any patent or patent rights of Analog Devices. Trademarks and registered trademarks are the property of their respective owners.

One Technology Way, P.O. Box 9106, Norwood, MA 02062-9106, U.S.A.
 Tel: 781.329.4700 ©2011–2016 Analog Devices, Inc. All rights reserved.
[Technical Support](#) www.analog.com

TABLE OF CONTENTS

Features	1	Loop Control State Machine	36
Applications	1	System Clock (SYSCLK)	37
General Description	1	System Clock Inputs	37
Functional Block Diagram	1	System Clock Multiplier	37
Revision History	3	Output PLL (APLL)	39
Specifications	5	Clock Distribution	40
Supply Voltage	5	RF Dividers (RF Divider 2 and RF Divider 1)	40
Supply Current	5	Channel Dividers	40
Power Dissipation	6	Output Power-Down	40
Logic Inputs ($\overline{\text{SYNC}}$, $\overline{\text{RESET}}$, PINCONTROL, M7 to M0)	6	Output Enable	40
Logic Outputs (M7 to M0, IRQ)	7	Output Mode	40
System Clock Inputs (XOA, XOB)	7	Clock Distribution Synchronization	41
Reference Inputs	8	Frame Synchronization	42
Reference Monitors	9	Reference Configuration in Frame Synchronization Mode	42
Reference Switchover Specifications	9	Clock Outputs in Frame Synchronization Mode	42
Distribution Clock Outputs	10	Control Registers for Frame Synchronization Mode	42
Time Duration of Digital Functions	11	Level Sensitive Mode and One-Shot Mode	42
Digital PLL	12	M3b Divider/OUT5 Programming in Frame Synchronization Mode	43
Digital PLL Lock Detection	12	Status and Control	44
Holdover Specifications	12	Multifunction Pins (M7 to M0)	44
Serial Port Specifications—SPI Mode	13	Watchdog Timer	45
Serial Port Specifications—I ² C Mode	14	EEPROM	45
Jitter Generation	14	Serial Control Port	51
Absolute Maximum Ratings	17	SPI/I ² C Port Selection	51
ESD Caution	17	SPI Serial Port Operation	51
Pin Configuration and Function Descriptions	18	I ² C Serial Port Operation	55
Typical Performance Characteristics	21	Programming the I/O Registers	58
Input/Output Termination Recommendations	26	Buffered/Active Registers	58
Getting Started	27	Autoclear Registers	58
Chip Power Monitor and Startup	27	Register Access Restrictions	58
Multifunction Pins at Reset/Power-Up	27	Thermal Performance	59
Device Register Programming Using a Register Setup File	27	Power Supply Partitions	60
Register Programming Overview	28	Recommended Configuration for 3.3 V Switching Supply	60
Theory of Operation	31	Configuration for 1.8 V Supply	60
Overview	31	Pin Program Function Description	61
Reference Clock Inputs	32	Overview of On-Chip ROM Features	61
Reference Monitors	32	Hard Pin Programming Mode	62
Reference Profiles	32	Soft Pin Programming Overview	63
Reference Switchover	32	Register Map	64
Digital PLL (DPLL) Core	33		

Register Map Bit Descriptions.....	73	Reference Inputs (Register 0x0500 to Register 0x0507)	86
Serial Port Configuration (Register 0x0000 to Register 0x0005)	73	Frame Synchronization (Register 0x0640 to Register 0x0641)	87
Silicon Revision (Register 0x000A)	73	DPLL Profile Registers (Register 0x0700 to Register 0x07E6)	88
Clock Part Serial ID (Register 0x000C to Register 0x000D)	73	Operational Controls (Register 0x0A00 to Register 0x0A10)	90
System Clock (Register 0x0100 to Register 0x0108)	74	Quick In/Out Frequency Soft Pin Configuration (Register 0x0C00 to Register 0x0C08)	93
General Configuration (Register 0x0200 to Register 0x0214)	75	Status Readback (Register 0x0D00 to Register 0x0D14)	95
IRQ Mask (Register 0x020A to Register 0x020F)	76	EEPROM Control (Register 0x0E00 to Register 0x0E03)	98
DPLL Configuration (Register 0x0300 to Register 0x032E)	77	EEPROM Storage Sequence (Register 0x0E10 to Register 0x0E3C)	99
Output PLL Configuration (Register 0x0400 to Register 0x0408)	80	Outline Dimensions.....	105
Output Clock Distribution (Register 0x0500 to Register 0x0515)	82	Ordering Guide	105

REVISION HISTORY

7/2016—Rev. B to Rev. C

Changes to Features Section, Applications Section, and General Description Section.....	1
Changes to Table 20	18
Changes to M0 to M6 Pin Description.....	20
Changes to Figure 33	26
Changes to Device Register Programming Using a Register Setup File Section	27
Added Figure 35 and Figure 36; Renumbered Sequentially.....	27
Added Figure 37	28
Changes to DPLL Overview Section and Figure 39	33
Changes to System Clock Details Section.....	37
Added RF Dividers (RF Divider 2 and RF Divider 1) Section.....	40
Changes to Control Registers for Frame Synchronization Mode Section.....	42
Changes to Manual EEPROM Download Section and Automatic EEPROM Download Section	47
Changes to Power Supply Partitions Section and Use of Ferrite Beads on 1.8 V Supplies Section.....	60
Added Use of Ferrite Beads on 3.3 V Supplies Section.....	60
Changes to Table 35	64
Changes to Read Buffer Register Description, Table 37	73
Changes to IRQ Pin Driver Type Description, Table 47	75
Changes to Table 64	80
Changes to Table 66	81
Changes to Table 86 and Table 87	89
Changes to Status Readback (Register 0x0D00 to Register 0x0D14) Section and Table 102	95
Changes to Table 110	97
Changes to Table 113	98

6/2013—Rev. A to Rev. B

Changes to Multifunction Pins (M7 to M0) Section.....	42
---	----

Change to Address 0x0101, Table 35.....	62
Changes to Bit 4, Table 43	73
Updated Outline Dimensions.....	104

4/2012—Rev 0 to Rev. A

Changed 3 Hz to 352 kHz in Output Frequencies List Item, Features Section.....	1
Change to Output Frequency Range Parameter, Min; and System Clock Input Doubler Duty Cycle Parameter Description, Table 6...6	6
Changes to Test Conditions/Comments Column, Table 9	8
Changes to Output Frequency Parameters, Min, Table 10	9
Changes to Pin 4 and Pin 42, Table 20	17
Changes to Device Register Programming When Using a Register Setup File and Register Programming Overview Sections.....	26
Changed APLL VCO Lower Frequency and OUT5 Frequency Range, Figure 35; Changed 225 MHz to 200 MHz and 3.45 GHz to 3.35 GHz in Overview Section	29
Changes to Reference Profiles Section	30
Changes to Programmable Digital Loop Filter Section	32
Changes to System Clock Inputs Section.....	35
Changes to Output PLL (APLL) Section; Changes to Figure 39.....	37
Changes to Figure 40; Changed 1024 to 1023 in Clock Dividers Section; Changes to Clock Distribution Synchronization Section	38
Changes to Multifunction Pins (M7 to M0) and IRQ Pin Sections.....	42
Changes to Figure 44	43
Changes to EEPROM Conditional Processing Section and Figure 45.....	46
Added Programming the EEPROM to Configure an M Pin to Control Synchronization of Clock Distribution Section	48
Changes to the Power Supply Partitions Section	58
Changed 89.5° to 88.5° in DPLL Phase Margin Section	59

Changes to Address 0x0006, Address 0x0007, and Address 0x000A, Table 35 62

Changes to Address 0x0304, Table 35..... 63

Changes to Address 0x0405, Table 35..... 64

Changes to Address 0x071A and Address 0x071D, Table 35 ... 65

Changes to Address 0x0780, Address 0x0785 to Address 0x078A, Address 0x079A, Address 0x079D, Table 35... 67

Changes to Address 0x07C0, Address 0x07DA, and Address 0x07DD, Table 35 68

Change to Address 0x0A01, Bit 7, Table 35 69

Added Address 0x0E3D to Address 0x0E45, Table 35 71

Change to Table 38; Added Table 40, Renumbered Sequentially; Changes to Table 41..... 72

Change to Bit 0, Address 0x0101, Table 43 73

Changes to Address 0x0304, Table 55..... 76

Deleted Address 0x0305, Table 55..... 76

Changes to Table Title, Table 63; Changes to Address 0x0400 and Address 0x0403, Table 64 79

Changes to Address 0x0405, Table 64..... 80

Changes to Descriptions, Address 0x0500, Table 67 81

Changes to Bit 0, Address 0x0501, Table 68..... 82

Changes to Bits[6:4], Address 0x0505 and Changes to Address 0x0506, Table 70 83

Changes to Bits[6:4] and Bit 0, Address 0x050F, Table 73 84

Change to Address 0x0704, Table 78; Changes to Bits[3:0] in Address 0x0707 and Address 070A, Table 79; and Changes to Address 0x070E, Table 82 87

Changes to Address 0x0710, Table 83; and Changes to Bits[3:0], Address 0x0714, Table 84 88

Changes to Bits[1:0], Address 0x0A01, Table 90..... 89

Changes to Descriptions, Address 0x0A0B, Table 99..... 91

Changes to Bit 4, Address 0x0C06, Table 100..... 93

Changes to Bit 6 and Bit 1, Address 0x0D01, Table 102..... 94

Changes to Table Summary, Table 114..... 98

Added Table 128 101

Changes to Table 129 102

Changes to Table 130 103

10/2011—Revision 0: Initial Version

SPECIFICATIONS

Minimum (min) and maximum (max) values apply for the full range of supply voltage and operating temperature variations. Typical (typ) values apply for AVDD3 = DVDD_I/O = 3.3 V; AVDD = DVDD = 1.8 V; T_A = 25°C, unless otherwise noted.

SUPPLY VOLTAGE

Table 1.

Parameter	Min	Typ	Max	Unit	Test Conditions/Comments
SUPPLY VOLTAGE					
DVDD3	3.135	3.30	3.465	V	
DVDD	1.71	1.80	1.89	V	
AVDD3	3.135	3.30	3.465	V	
AVDD	1.71	1.80	1.89	V	

SUPPLY CURRENT

The test conditions for the maximum (max) supply current are the same as the test conditions for the All Blocks Running parameter of Table 3. The test conditions for the typical (typ) supply current are the same as the test conditions for the Typical Configuration parameter of Table 3.

Table 2.

Parameter	Min	Typ	Max	Unit	Test Conditions/Comments
SUPPLY CURRENT FOR TYPICAL CONFIGURATION					
I _{DVDD3}	12	19	26	mA	Pin 45, Pin 46, Pin 51, Pin 52, Pin 64
I _{DVDD}	12	20	28	mA	Pin 6, Pin 55, Pin 56
I _{AVDD3}	50	70	92	mA	Pin 25, Pin 26, Pin 31
I _{AVDD}	152	230	305	mA	Pin 7, Pin 10, Pin 12, Pin 17, Pin 22, Pin 29, Pin 30, Pin 35, Pin 37, Pin 38
SUPPLY CURRENT FOR THE ALL BLOCKS RUNNING CONFIGURATION					
I _{DVDD3}	23	34	46	mA	Pin 45, Pin 46, Pin 51, Pin 52, Pin 64
I _{DVDD}	11	22	32	mA	Pin 6, Pin 55, Pin 56
I _{AVDD3}	73	108	143	mA	Pin 25, Pin 26, Pin 31
I _{AVDD}	168	250	331	mA	Pin 7, Pin 10, Pin 12, Pin 17, Pin 22, Pin 29, Pin 30, Pin 35, Pin 37, Pin 38

POWER DISSIPATION

Table 3.

Parameter	Min	Typ	Max	Unit	Test Conditions/Comments
POWER DISSIPATION					
Typical Configuration	0.47	0.74	1.02	W	System clock: 49.152 MHz crystal; DPLL active; both 19.44 MHz input references in differential mode; one HSTL driver at 644.53125 MHz; one 3.3 V CMOS driver at 161.1328125 MHz and 80 pF capacitive load on CMOS output
All Blocks Running	0.6	1.0	1.32	W	System clock: 49.152 MHz crystal; DPLL active; both input references in differential mode; four HSTL drivers at 750 MHz; four 3.3 V CMOS drivers at 250 MHz and 80 pF capacitive load on CMOS outputs
Full Power-Down		44	125	mW	Typical configuration with no external pull-up or pull-down resistors; approximately 2/3 of this power is on AVDD3
Incremental Power Dissipation					
Input Reference On/Off					
Differential Without Divide-by-2	20	25	32	mW	Additional current draw is in the DVDD3 domain only
Differential With Divide-by-2	26	32	40	mW	Additional current draw is in the DVDD3 domain only
Single-Ended (Without Divide-by-2)	5	7	9	mW	Additional current draw is in the DVDD3 domain only
Output Distribution Driver On/Off					
LVDS (at 750 MHz)	12	17	22	mW	Additional current draw is in the AVDD domain only
HSTL (at 750 MHz)	14	21	28	mW	Additional current draw is in the AVDD domain only
1.8 V CMOS (at 250 MHz)	14	21	28	mW	A single 1.8 V CMOS output with an 80 pF load
3.3 V CMOS (at 250 MHz)	18	27	36	mW	A single 3.3 V CMOS output with an 80 pF load
Other Blocks On/Off					
Second RF Divider	36	51	64	mW	Additional current draw is in the AVDD domain only
Channel Divider Bypassed	10	17	23	mW	Additional current draw is in the AVDD domain only

LOGIC INPUTS (SYNC, RESET, PINCONTROL, M7 TO M0)

Table 4.

Parameter	Min	Typ	Max	Unit	Test Conditions/Comments
LOGIC INPUTS (SYNC, RESET, PINCONTROL)					
Input High Voltage (V_{IH})	2.1			V	
Input Low Voltage (V_{IL})			0.8	V	
Input Current (I_{INH} , I_{INL})		±50	±100	µA	
Input Capacitance (C_{IN})		3		pF	
LOGIC INPUTS (M7 to M0)					
Input High Voltage (V_{IH})	2.5			V	
Input ½ Level Voltage (V_{IM})	1.0		2.2	V	
Input Low Voltage (V_{IL})			0.6	V	
Input Current (I_{INH} , I_{INL})		±60	±100	µA	
Input Capacitance (C_{IN})		3		pF	

LOGIC OUTPUTS (M7 TO M0, IRQ)

Table 5.

Parameter	Min	Typ	Max	Unit	Test Conditions/Comments
LOGIC OUTPUTS (M7 to M0, IRQ)					
Output High Voltage (V_{OH})	DVDD3 – 0.4			V	$I_{OH} = 1\text{ mA}$
Output Low Voltage (V_{OL})			0.4	V	$I_{OL} = 1\text{ mA}$
IRQ Leakage Current					Open-drain mode
Active Low Output Mode			–200	μA	$V_{OH} = 3.3\text{ V}$
Active High Output Mode			100	μA	$V_{OL} = 0\text{ V}$

SYSTEM CLOCK INPUTS (XOA, XOB)

Table 6.

Parameter	Min	Typ	Max	Unit	Test Conditions/Comments
SYSTEM CLOCK MULTIPLIER					
Output Frequency Range	750		805	MHz	The VCO range may place limitations on nonstandard system clock input frequencies
Phase Frequency Detector (PFD) Rate			150	MHz	
Frequency Multiplication Range	2		255		Assumes valid system clock and PFD rates
SYSTEM CLOCK REFERENCE INPUT PATH					
Input Frequency Range	10		600	MHz	
Minimum Input Slew Rate	20			V/ μs	Minimum limit imposed for jitter performance
Common-Mode Voltage	1.05	1.16	1.25	V	Internally generated
Differential Input Voltage Sensitivity	250			mV p-p	Minimum voltage across pins required to ensure switching between logic states; the instantaneous voltage on either pin must not exceed the supply rails; can accommodate single-ended input by ac grounding of complementary input; 1 V p-p recommended for optimal jitter performance
System Clock Input Doubler Duty Cycle					This is the amount of duty cycle variation that can be tolerated on the system clock input to use the doubler
System Clock Input = 50 MHz	45	50	55	%	
System Clock Input = 20 MHz	46	50	54	%	
System Clock Input = 16 MHz to 20 MHz	47	50	53	%	
Input Capacitance		3		pF	Single-ended, each pin
Input Resistance		4.2		k Ω	
CRYSTAL RESONATOR PATH					
Crystal Resonator Frequency Range	10		50	MHz	Fundamental mode, AT cut crystal
Maximum Crystal Motional Resistance			100	Ω	

REFERENCE INPUTS

Table 7.

Parameter	Min	Typ	Max	Unit	Test Conditions/Comments
DIFFERENTIAL OPERATION					
Frequency Range					
Sinusoidal Input	10		750	MHz	
LVPECL Input	0.002		1250	MHz	The reference input divide-by-2 block must be engaged for $f_{IN} > 705$ MHz
LVDS Input	0.002		750	MHz	The reference input divide-by-2 block must be engaged for $f_{IN} > 705$ MHz
Minimum Input Slew Rate	40			V/ μ s	Minimum limit imposed for jitter performance
Common-Mode Input Voltage					
AC-Coupled	1.9	2	2.2	V	Internally generated
DC-Coupled	1.0		2.4	V	
Differential Input Voltage Sensitivity				mV	Minimum differential voltage across pins is required to ensure switching between logic levels; instantaneous voltage on either pin must not exceed the supply rails
$f_{IN} < 800$ MHz	240			mV	
$f_{IN} = 800$ to 1050 MHz	320			mV	
$f_{IN} = 1050$ to 1250 MHz	400			mV	
Differential Input Voltage Hysteresis		58	100	mV	
Input Resistance		21		k Ω	
Input Capacitance		3		pF	
Minimum Pulse Width High					
LVPECL	390			ps	
LVDS	640			ps	
Minimum Pulse Width Low					
LVPECL	390			ps	
LVDS	640			ps	
SINGLE-ENDED OPERATION					
Frequency Range (CMOS)	0.002		300	MHz	
Minimum Input Slew Rate	40			V/ μ s	Minimum limit imposed for jitter performance
Input Voltage High (V_{IH})					
1.2 V to 1.5 V Threshold Setting	1.0			V	
1.8 V to 2.5 V Threshold Setting	1.4			V	
3.0 V to 3.3 V Threshold Setting	2.0			V	
Input Voltage Low (V_{IL})					
1.2 V to 1.5 V Threshold Setting			0.35	V	
1.8 V to 2.5 V Threshold Setting			0.5	V	
3.0 V to 3.3 V Threshold Setting			1.0	V	
Input Resistance		47		k Ω	
Input Capacitance		3		pF	
Minimum Pulse Width High	1.5			ns	
Minimum Pulse Width Low	1.5			ns	

REFERENCE MONITORS

Table 8.

Parameter	Min	Typ	Max	Unit	Test Conditions/Comments
REFERENCE MONITORS					
Reference Monitor					
Loss of Reference Detection Time			1.1	DPLL PFD period	Nominal phase detector period = R/f_{REF}^1
Frequency Out-of-Range Limits	<2		10^5	$\Delta f/f_{REF}$ (ppm)	Programmable (lower bound is subject to quality of the system clock (SYSCLK)); SYSCLK accuracy must be better than the lower bound
Validation Timer	0.001		65.535	sec	Programmable in 1 ms increments

¹ f_{REF} is the frequency of the active reference; R is the frequency division factor determined by the R-divider.

REFERENCE SWITCHOVER SPECIFICATIONS

Table 9.

Parameter	Min	Typ	Max	Unit	Test Conditions/Comments
REFERENCE SWITCHOVER SPECIFICATIONS					
Maximum Output Phase Perturbation (Phase Build-Out Switchover)					Assumes a jitter-free reference; satisfies Telcordia GR-1244-CORE requirements; select high PM base loop filter bit (Register 0x070E, Bit 0) is set to 1 for all active references
50 Hz DPLL Loop Bandwidth					Valid for automatic and manual reference switching
Peak		0	± 100	ps	
Steady State		0	± 100	ps	
2 kHz DPLL Loop Bandwidth					Valid for automatic and manual reference switching
Peak		0	± 250	ps	
Steady State		0	± 100	ps	
Time Required to Switch to a New Reference					
Phase Build-Out Switchover			1.1	DPLL PFD period	Calculated using the nominal phase detector period ($NPDP = R/f_{REF}$); the total time required is equal to the time plus the reference validation time and the time required to lock to the new reference

DISTRIBUTION CLOCK OUTPUTS

Table 10.

Parameter	Min	Typ	Max	Unit	Test Conditions/Comments
HSTL MODE					
Output Frequency	0.000352		1250	MHz	OUT5 only; OUT0 to OUT4 minimum output frequency is 360 kHz
Rise/Fall Time (20% to 80%) ¹		140	250	ps	100 Ω termination across output pins
Duty Cycle					
Up to $f_{OUT} = 700$ MHz	45	48	52	%	
Up to $f_{OUT} = 750$ MHz	42	48	53	%	
Up to $f_{OUT} = 1250$ MHz		43		%	
Differential Output Voltage Swing	700	950	1200	mV	Magnitude of voltage across pins; output driver static
Common-Mode Output Voltage	700	870	960	mV	Output driver static
LVDS MODE					
Output Frequency	0.000352		1250	MHz	OUT5 only; OUT0 to OUT4 minimum output frequency is 360 kHz
Rise/Fall Time (20% to 80%) ¹		185	280	ps	100 Ω termination across the output pair
Duty Cycle					
Up to $f_{OUT} = 750$ MHz	44	48	53	%	
Up to $f_{OUT} = 800$ MHz	43	47	53	%	
Up to $f_{OUT} = 1250$ MHz		43		%	
Differential Output Voltage Swing					
Balanced, V_{OD}	247		454	mV	Voltage swing between output pins; output driver static
Unbalanced, ΔV_{OD}			50	mV	Absolute difference between voltage swing of normal pin and inverted pin; output driver static
Offset Voltage					
Common-Mode, V_{OS}	1.125	1.26	1.375	V	Output driver static
Common-Mode Difference, ΔV_{OS}			50	mV	Voltage difference between pins; output driver static
Short-Circuit Output Current		13	24	mA	Output driver static
CMOS MODE					
Output Frequency					
1.8 V Supply	0.000352		150	MHz	OUT5 only; OUT0 to OUT4 minimum output frequency is 360 kHz
3.3 V Supply (OUT0 and OUT5)					10 pF load
Strong Drive Strength Setting	0.000352		250	MHz	10 pF load
Weak Drive Strength Setting	0.000352		25	MHz	10 pF load
Rise/Fall Time (20% to 80%) ¹					
1.8 V Supply		1.5	3	ns	10 pF load
3.3 V Supply					
Strong Drive Strength Setting		0.4	0.6	ns	10 pF load
Weak Drive Strength Setting		8		ns	10 pF load
Duty Cycle					
1.8 V Mode		50		%	10 pF load
3.3 V Strong Mode		47		%	10 pF load
3.3 V Weak Mode		51		%	10 pF load
Output Voltage High (V_{OH})					
AVDD3 = 3.3 V, $I_{OH} = 10$ mA	AVDD3 – 0.3			V	Output driver static; strong drive strength
AVDD3 = 3.3 V, $I_{OH} = 1$ mA	AVDD3 – 0.1			V	
AVDD3 = 1.8 V, $I_{OH} = 1$ mA	AVDD – 0.2			V	
Output Voltage Low (V_{OL})					
AVDD3 = 3.3 V, $I_{OL} = 10$ mA			0.3	V	Output driver static; strong drive strength
AVDD3 = 3.3 V, $I_{OL} = 1$ mA			0.1	V	
AVDD3 = 1.8 V, $I_{OL} = 1$ mA			0.1	V	

Parameter	Min	Typ	Max	Unit	Test Conditions/Comments
OUTPUT TIMING SKEW					10 pF load
Between OUT0 and OUT1		10	70	ps	HSTL mode on both drivers; rising edge only; any divide value
Between OUT0 and OUT3		105	222	ps	HSTL mode on both drivers; rising edge only; any divide value
Between OUT0 and OUT5		1.39	1.76	ns	HSTL mode on both drivers; rising edge only; any divide value
Between OUT1 and OUT2 (OUT1 and OUT2 Share the Same Divider)		1	12	ps	HSTL mode on both drivers; rising edge only; any divide value
Between OUT3 and OUT4 (OUT3 and OUT4 Share the Same Divider)		1	24	ps	HSTL mode on both drivers; rising edge only; any divide value
Across All OUT0 to OUT4 HSTL		105	235	ps	HSTL mode on all drivers; rising edge only; any divide value
Across All OUT0 to OUT4 LVDS		100	235	ps	LVDS mode on all drivers; rising edge only; any divide value
Additional Delay on One Driver by Changing Its Logic Type					
HSTL to LVDS	-5	+1	+5	ps	Positive value indicates that the LVDS edge is delayed relative to HSTL
HSTL to 1.8 V CMOS	-5	0	+5	ps	Positive value indicates that the CMOS edge is delayed relative to HSTL
HSTL to 3.3 V CMOS, Strong Mode					The CMOS edge is delayed relative to HSTL
OUT0 CMOS to OUT1 HSTL		3.53	3.59	ns	
OUT0 CMOS to OUT3 HSTL		3.55	3.65	ns	
OUT0 CMOS to OUT4 HSTL		3.56	3.68	ns	
OUT0 CMOS to OUT5 HSTL		4.84	5.1	ns	

¹ The listed values are for the slower edge (rise or fall).

TIME DURATION OF DIGITAL FUNCTIONS

Table 11.

Parameter	Min	Typ	Max	Unit	Test Conditions/Comments
TIME DURATION OF DIGITAL FUNCTIONS					
EEPROM-to-Register Download Time		13	20	ms	Using default EEPROM storage sequence (see Register 0x0E10 to Register 0x0E3F)
Register-to-EEPROM Upload Time		138	145	ms	Using default EEPROM storage sequence (see Register 0x0E10 to Register 0x0E3F)
Minimum Power-Down Exit Time		1		ms	Time from power-down exit to system clock lock detect

DIGITAL PLL

Table 12.

Parameter	Min	Typ	Max	Unit	Test Conditions/Comments
DIGITAL PLL					
Phase-Frequency Detector (PFD) Input Frequency Range	2		100	kHz	
Loop Bandwidth	0.1		2000	Hz	Programmable design parameter
Phase Margin	30		89	Degrees	Programmable design parameter
Closed-Loop Peaking	<0.1			dB	Programmable design parameter; device can be programmed for <0.1 dB peaking in accordance with Telcordia GR-253 jitter transfer
Reference Input (R) Division Factor	1		2 ²⁰		1, 2, ..., 1,048,576
Integer Feedback (N1) Division Factor	180		2 ¹⁷		180, 181, ..., 131,072
Fractional Feedback Divide Ratio	0		0.999		Maximum value: 16,777,215/16,777,216

DIGITAL PLL LOCK DETECTION

Table 13.

Parameter	Min	Typ	Max	Unit	Test Conditions/Comments
PHASE LOCK DETECTOR					
Threshold Programming Range	0.001		65.5	ns	
Threshold Resolution		1		ps	
FREQUENCY LOCK DETECTOR					
Threshold Programming Range	0.001		16,700	ns	Reference to feedback period difference
Threshold Resolution		1		ps	

HOLDOVER SPECIFICATIONS

Table 14.

Parameter	Min	Typ	Max	Unit	Test Conditions/Comments
HOLDOVER SPECIFICATIONS					
Initial Frequency Accuracy		<0.01		ppm	Excludes frequency drift of SYSCLK source; excludes frequency drift of input reference prior to entering holdover; compliant with GR-1244 Stratum 3

SERIAL PORT SPECIFICATIONS—SPI MODE

Table 15.

Parameter	Min	Typ	Max	Unit	Test Conditions/Comments
$\overline{\text{CS}}$					
Input Logic 1 Voltage		2.0		V	
Input Logic 0 Voltage		0.8		V	
Input Logic 1 Current		60		μA	
Input Logic 0 Current		100		μA	
Input Capacitance		2		pF	
SCLK					Internal 30 k Ω pull-down resistor
Input Logic 1 Voltage		2.0		V	
Input Logic 0 Voltage		0.8		V	
Input Logic 1 Current		200		μA	
Input Logic 0 Current		1		μA	
Input Capacitance		2		pF	
SDIO					
As an Input					
Input Logic 1 Voltage		2.0		V	
Input Logic 0 Voltage		0.8		V	
Input Logic 1 Current		1		μA	
Input Logic 0 Current		1		μA	
Input Capacitance		2		pF	
As an Output					
Output Logic 1 Voltage	DVDD3 – 0.6			V	1 mA load current
Output Logic 0 Voltage			0.4	V	1 mA load current
SDO					
Output Logic 1 Voltage	DVDD3 – 0.6			V	1 mA load current
Output Logic 0 Voltage			0.4	V	1 mA load current
TIMING					
SCLK					
Clock Rate, $1/t_{\text{CLK}}$			40	MHz	
Pulse Width High (t_{HIGH})	10			ns	
Pulse Width Low (t_{LOW})	13			ns	
SDIO to SCLK Setup (t_{DS})	3			ns	
SCLK to SDIO Hold (t_{DH})	6			ns	
SCLK to Valid SDIO and SDO (t_{DV})			10	ns	
$\overline{\text{CS}}$ to SCLK Setup (t_{S})	10			ns	
$\overline{\text{CS}}$ to SCLK Hold (t_{c})	0			ns	
$\overline{\text{CS}}$ Minimum Pulse Width High	6			ns	

SERIAL PORT SPECIFICATIONS—I²C MODE

Table 16.

Parameter	Min	Typ	Max	Unit	Test Conditions/Comments
SDA, SCL (AS INPUT)					
Input Logic 1 Voltage	0.7 × DVDD3			V	
Input Logic 0 Voltage			0.3 × DVDD3	V	
Input Current	-10		+10	μA	For V _{IN} = 10% to 90% DVDD3
Hysteresis of Schmitt Trigger Inputs	0.015 × DVDD3				
Pulse Width of Spikes That Must Be Suppressed by the Input Filter (t _{SP})			50	ns	
SDA (AS OUTPUT)					
Output Logic 0 Voltage			0.4	V	I _O = 3 mA
Output Fall Time from V _{IHmin} to V _{ILmax}	20 + 0.1 × C _b ¹		250	ns	10 pF ≤ C _b ≤ 400 pF
TIMING					
SCL Clock Rate			400	kHz	
Bus-Free Time Between a Stop and Start Condition (t _{BUF})	1.3			μs	
Repeated Start Condition Setup Time (t _{SU,STA})	0.6			μs	
Repeated Hold Time Start Condition (t _{HD,STA})	0.6			μs	After this period, the first clock pulse is generated
Stop Condition Setup Time (t _{SU,STO})	0.6			μs	
Low Period of the SCL Clock (t _{LOW})	1.3			μs	
High Period of the SCL Clock (t _{HIGH})	0.6			μs	
SCL/SDA Rise Time (t _r)	20 + 0.1 × C _b ¹		300	ns	
SCL/SDA Fall Time (t _f)	20 + 0.1 × C _b ¹		300	ns	
Data Setup Time (t _{SU,DAT})	100			ns	
Data Hold Time (t _{HD,DAT})	100			ns	
Capacitive Load for Each Bus Line (C _b) ¹			400	pF	

¹ C_b is the capacitance (pF) of a single bus line.

JITTER GENERATION

Jitter generation (random jitter) uses 49.152 MHz crystal for system clock input.

Table 17.

Parameter	Min	Typ	Max	Unit	Test Conditions/Comments
JITTER GENERATION					System clock doubler enabled; high phase margin mode enabled; Register 0x0405 = 0x20; Register 0x0403 = 0x07; Register 0x0400 = 0x81; in cases where multiple driver types are listed, both driver types were tested at those conditions, and the one with higher jitter is quoted, although there is usually not a significant jitter difference between the driver types
f _{REF} = 19.44 MHz; f _{OUT} = 622.08 MHz; f _{LOOP} = 50 Hz; HSTL Driver					
Bandwidth: 5 kHz to 20 MHz		304		fs rms	
Bandwidth: 12 kHz to 20 MHz		296		fs rms	
Bandwidth: 20 kHz to 80 MHz		300		fs rms	
Bandwidth: 50 kHz to 80 MHz		266		fs rms	
Bandwidth: 16 MHz to 320 MHz		185		fs rms	

Parameter	Min	Typ	Max	Unit	Test Conditions/Comments
$f_{REF} = 19.44 \text{ MHz}$; $f_{OUT} = 644.53 \text{ MHz}$; $f_{LOOP} = 50 \text{ Hz}$; HSTL and/or LVDS Driver					
Bandwidth: 5 kHz to 20 MHz		334		fs rms	
Bandwidth: 12 kHz to 20 MHz		321		fs rms	
Bandwidth: 20 kHz to 80 MHz		319		fs rms	
Bandwidth: 50 kHz to 80 MHz		277		fs rms	
Bandwidth: 16 MHz to 320 MHz		185		fs rms	
$f_{REF} = 19.44 \text{ MHz}$; $f_{OUT} = 693.48 \text{ MHz}$; $f_{LOOP} = 50 \text{ Hz}$; HSTL Driver					
Bandwidth: 5 kHz to 20 MHz		298		fs rms	
Bandwidth: 12 kHz to 20 MHz		285		fs rms	
Bandwidth: 20 kHz to 80 MHz		286		fs rms	
Bandwidth: 50 kHz to 80 MHz		252		fs rms	
Bandwidth: 16 MHz to 320 MHz		183		fs rms	
$f_{REF} = 19.44 \text{ MHz}$; $f_{OUT} = 174.703 \text{ MHz}$; $f_{LOOP} = 1 \text{ kHz}$; HSTL Driver					
Bandwidth: 5 kHz to 20 MHz		354		fs rms	
Bandwidth: 12 kHz to 20 MHz		301		fs rms	
Bandwidth: 20 kHz to 80 MHz		321		fs rms	
Bandwidth: 50 kHz to 80 MHz		290		fs rms	
Bandwidth: 4 MHz to 80 MHz		177		fs rms	
$f_{REF} = 19.44 \text{ MHz}$; $f_{OUT} = 174.703 \text{ MHz}$; $f_{LOOP} = 100 \text{ Hz}$; LVDS and/or 3.3 V CMOS Driver					
Bandwidth: 5 kHz to 20 MHz		306		fs rms	
Bandwidth: 12 kHz to 20 MHz		293		fs rms	
Bandwidth: 20 kHz to 80 MHz		313		fs rms	
Bandwidth: 50 kHz to 80 MHz		283		fs rms	
Bandwidth: 4 MHz to 80 MHz		166		fs rms	
$f_{REF} = 25 \text{ MHz}$; $f_{OUT} = 161.1328 \text{ MHz}$; $f_{LOOP} = 100 \text{ Hz}$; HSTL Driver					
Bandwidth: 5 kHz to 20 MHz		316		fs rms	
Bandwidth: 12 kHz to 20 MHz		302		fs rms	
Bandwidth: 20 kHz to 80 MHz		324		fs rms	
Bandwidth: 50 kHz to 80 MHz		292		fs rms	
Bandwidth: 4 MHz to 80 MHz		171		fs rms	
$f_{REF} = 2 \text{ kHz}$; $f_{OUT} = 70.656 \text{ MHz}$; $f_{LOOP} = 100 \text{ Hz}$; HSTL and/or 3.3 V CMOS Driver					
Bandwidth: 10 Hz to 30 MHz		3.22		ps rms	
Bandwidth: 5 kHz to 20 MHz		338		fs rms	
Bandwidth: 12 kHz to 20 MHz		324		fs rms	
Bandwidth: 10 kHz to 400 kHz		278		fs rms	
Bandwidth: 100 kHz to 10 MHz		210		fs rms	
$f_{REF} = 25 \text{ MHz}$; $f_{OUT} = 1 \text{ GHz}$; $f_{LOOP} = 500 \text{ Hz}$; HSTL Driver					
Bandwidth: 100 Hz to 500 MHz (Broadband)		1.71		ps rms	
Bandwidth: 12 kHz to 20 MHz		343		fs rms	
Bandwidth: 20 kHz to 80 MHz		338		fs rms	

Jitter generation (random jitter) uses 19.2 MHz TCXO for system clock input.

Table 18.

Parameter	Min	Typ	Max	Unit	Test Conditions/Comments
JITTER GENERATION					System clock doubler enabled; high phase margin mode enabled; Register 0x0405 = 0x20; Register 0x0403 = 0x07; Register 0x0400 = 0x81; in cases where multiple driver types are listed, both driver types were tested at those conditions, and the one with higher jitter is quoted, although there is usually not a significant jitter difference between the driver types
$f_{REF} = 19.44 \text{ MHz}; f_{OUT} = 644.53 \text{ MHz}; f_{LOOP} = 0.1 \text{ Hz};$ HSTL Driver					
Bandwidth: 5 kHz to 20 MHz		402		fs rms	
Bandwidth: 12 kHz to 20 MHz		393		fs rms	
Bandwidth: 20 kHz to 80 MHz		391		fs rms	
Bandwidth: 50 kHz to 80 MHz		347		fs rms	
Bandwidth: 16 MHz to 320 MHz		179		fs rms	
$f_{REF} = 19.44 \text{ MHz}; f_{OUT} = 693.48 \text{ MHz}; f_{LOOP} = 0.1 \text{ Hz};$ HSTL Driver					
Bandwidth: 5 kHz to 20 MHz		379		fs rms	
Bandwidth: 12 kHz to 20 MHz		371		fs rms	
Bandwidth: 20 kHz to 80 MHz		371		fs rms	
Bandwidth: 50 kHz to 80 MHz		335		fs rms	
Bandwidth: 16 MHz to 320 MHz		175		fs rms	
$f_{REF} = 19.44 \text{ MHz}; f_{OUT} = 312.5 \text{ MHz}; f_{LOOP} = 0.1 \text{ Hz};$ HSTL Driver					
Bandwidth: 5 kHz to 20 MHz		413		fs rms	
Bandwidth: 12 kHz to 20 MHz		404		fs rms	
Bandwidth: 20 kHz to 80 MHz		407		fs rms	
Bandwidth: 50 kHz to 80 MHz		358		fs rms	
Bandwidth: 4 MHz to 80 MHz		142		fs rms	
$f_{REF} = 25 \text{ MHz}; f_{OUT} = 161.1328 \text{ MHz}; f_{LOOP} = 0.1 \text{ Hz};$ HSTL Driver					
Bandwidth: 5 kHz to 20 MHz		399		fs rms	
Bandwidth: 12 kHz to 20 MHz		391		fs rms	
Bandwidth: 20 kHz to 80 MHz		414		fs rms	
Bandwidth: 50 kHz to 80 MHz		376		fs rms	
Bandwidth: 4 MHz to 80 MHz		190		fs rms	
$f_{REF} = 2 \text{ kHz}; f_{OUT} = 70.656 \text{ MHz}; f_{LOOP} = 0.1 \text{ Hz};$ HSTL and/or 3.3 V CMOS Driver					
Bandwidth: 10 Hz to 30 MHz		970		fs rms	
Bandwidth: 12 kHz to 20 MHz		404		fs rms	
Bandwidth: 10 kHz to 400 kHz		374		fs rms	
Bandwidth: 100 kHz to 10 MHz		281		fs rms	

ABSOLUTE MAXIMUM RATINGS

Table 19.

Parameter	Rating
Analog Supply Voltage (AVDD)	2 V
Digital Supply Voltage (DVDD)	2 V
Digital I/O Supply Voltage (DVDD3)	3.6 V
Analog Supply Voltage (AVDD3)	3.6 V
Maximum Digital Input Voltage	-0.5 V to DVDD3 + 0.5 V
Storage Temperature Range	-65°C to +150°C
Operating Temperature Range	-40°C to +85°C
Lead Temperature (Soldering 10 sec)	300°C
Maximum Junction Temperature	150°C

Stresses at or above those listed under Absolute Maximum Ratings may cause permanent damage to the product. This is a stress rating only; functional operation of the product at these or any other conditions above those indicated in the operational section of this specification is not implied. Operation beyond the maximum operating conditions for extended periods may affect product reliability.

ESD CAUTION



ESD (electrostatic discharge) sensitive device. Charged devices and circuit boards can discharge without detection. Although this product features patented or proprietary protection circuitry, damage may occur on devices subjected to high energy ESD. Therefore, proper ESD precautions should be taken to avoid performance degradation or loss of functionality.

PIN CONFIGURATION AND FUNCTION DESCRIPTIONS

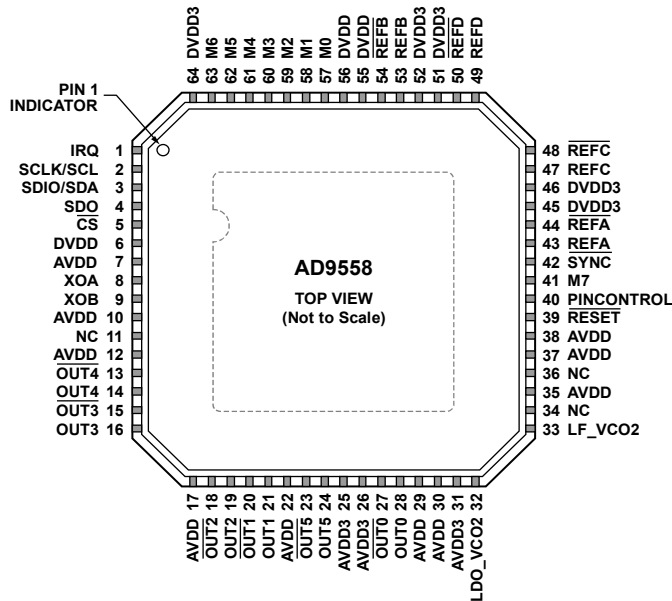

- NOTES
 1. NC = NO CONNECT. DO NOT CONNECT TO THIS PIN.
 2. THE EXPOSED PAD MUST BE CONNECTED TO GROUND (VSS).

Figure 2. Pin Configuration

09758-002

Table 20. Pin Function Descriptions

Pin No.	Mnemonic	Input/Output	Pin Type	Description
1	IRQ	O	3.3 V CMOS	Interrupt Request Line.
2	SCLK/SCL	I	3.3 V CMOS	Serial Programming Clock (SCLK) in SPI Mode. Data clock for serial programming. Open-Collector Serial Clock Pin (SCL) in I ² C Mode. Requires a pull-up resistor, usually 2.2 k Ω ; the resistor size depends on the number of I ² C devices on the bus.
3	SDIO/SDA	I/O	3.3 V CMOS	Serial Data Input/Output (SDIO) in SPI Mode. When the device is in 4-wire SPI mode, data is written via this pin. In 3-wire SPI mode, both data reads and writes occur on this pin. There is no internal pull-up/pull-down resistor on this pin. Open-Collector Serial Data Pin (SDA) in I ² C Mode. Requires a pull-up resistor, usually 2.2 k Ω ; the resistor size depends on the number of I ² C devices on the bus.
4	SDO	O	3.3 V CMOS	Serial Data Output. Use this pin to read data in 4-wire mode. There is no internal pull-up/pull-down resistor on this pin. This pin is high impedance in the default 3-wire mode.
5	\overline{CS}	I	3.3 V CMOS	Chip Select (SPI), Active Low. When programming a device, this pin must be held low. In systems where more than one AD9558 is present, this pin enables individual programming of each AD9558. This pin has an internal 10 k Ω pull-up resistor.
6, 55, 56	DVDD	I	Power	1.8 V Digital Supply.
7	AVDD	I	Power	1.8 V Analog (SYSCLK) Power Supply.
8	XOA	I	Differential input	System Clock Input. XOA contains internal dc biasing. It is recommended to ac couple XOA with a 0.01 μ F capacitor, except when using a crystal. If a crystal is used, connect the crystal across XOA and XOB. Single-ended 1.8 V CMOS is also an option but can introduce a spur if the duty cycle is not 50%. When using XOA as a single-ended input, connect a 0.01 μ F capacitor from XOB to ground.
9	XOB	I	Differential input	Complementary System Clock Input. Complementary signal to XOA. XOB contains internal dc biasing. It is recommended to ac couple XOB with a 0.01 μ F capacitor, except when using a crystal. If a crystal is used, connect the crystal across XOA and XOB.
10	AVDD	I	Power	1.8 V Analog (VCO) Power Supply.
11	NC	I		No Connection. Do not connect to this pin.
12, 17, 22, 29	AVDD	I	Power	1.8 V Analog (Output Driver) Power Supply.

Pin No.	Mnemonic	Input/ Output	Pin Type	Description
13	OUT4	O	HSTL, LVDS, or 1.8 V CMOS	Complementary Output 4. This output can be configured as HSTL, LVDS, or single-ended 1.8 V CMOS.
14	OUT4	O	HSTL, LVDS, or 1.8 V CMOS	Output 4. This output can be configured as HSTL, LVDS, or single-ended 1.8 V CMOS. LVPECL levels can be achieved by ac coupling and using the Thevenin-equivalent termination as described in the Input/Output Termination Recommendations section.
15	$\overline{\text{OUT3}}$	O	HSTL, LVDS, or 1.8 V CMOS	Complementary Output 3. This output can be configured as HSTL, LVDS, or single-ended 1.8 V CMOS.
16	OUT3	O	HSTL, LVDS, or 1.8 V CMOS	Output 3. This output can be configured as HSTL, LVDS, or single-ended 1.8 V CMOS. LVPECL levels can be achieved by ac coupling and using the Thevenin-equivalent termination as described in the Input/Output Termination Recommendations section.
18	$\overline{\text{OUT2}}$	O	HSTL, LVDS, or 1.8 V CMOS	Complementary Output 2. This output can be configured as HSTL, LVDS, or single-ended 1.8 V CMOS.
19	OUT2	O	HSTL, LVDS, or 1.8 V CMOS	Output 2. This output can be HSTL, LVDS, or single-ended 1.8 V CMOS. LVPECL levels can be achieved by ac coupling and using the Thevenin-equivalent termination as described in the Input/Output Termination Recommendations section.
20	$\overline{\text{OUT1}}$	O	HSTL, LVDS, or 1.8 V CMOS	Complementary Output 1. This output can be configured as HSTL, LVDS, or single-ended 1.8 V CMOS.
21	OUT1	O	HSTL, LVDS, or 1.8 V CMOS	Output 1. This output can be configured as HSTL, LVDS, or single-ended 1.8 V CMOS. LVPECL levels can be achieved by ac coupling and using the Thevenin-equivalent termination as described in the Input/Output Termination Recommendations section.
23	$\overline{\text{OUT5}}$	O	HSTL, LVDS, 1.8 V CMOS, 3.3 V CMOS	Complementary Output 5. This output can be configured as HSTL, LVDS, or single-ended 1.8 V or 3.3 V CMOS.
24	OUT5	O	HSTL, LVDS, 1.8 V CMOS, 3.3 V CMOS	Output 5. This output can be configured as HSTL, LVDS, or single-ended 1.8 V or 3.3 V CMOS. LVPECL levels can be achieved by ac coupling and by using the Thevenin-equivalent termination as described in the Input/Output Termination Recommendations section.
25, 26	AVDD3	I	Power	3.3 V Analog (Output Driver) Power Supply.
27	$\overline{\text{OUT0}}$	O	HSTL, LVDS, 1.8 V CMOS, 3.3 V CMOS	Complementary Output 0. This output can be configured as HSTL, LVDS, or single-ended 1.8 V or 3.3 V CMOS.
28	OUT0	O	HSTL, LVDS, 1.8 V CMOS, 3.3 V CMOS	Output 0. This output can be configured as HSTL, LVDS, or single-ended 1.8 V or 3.3 V CMOS. LVPECL levels can be achieved by ac coupling and by using the Thevenin-equivalent termination as described in the Input/Output Termination Recommendations section.
30	AVDD	I	Power	1.8 V Analog (RF Divider) Power Supply.
31	AVDD3	I	Power	3.3 V Analog (VCO 2) Power Supply.
32	LDO_VCO2	I	LDO bypass	Output PLL Loop Filter Voltage Regulator. Connect a 0.47 μF capacitor from this pin to ground. This pin is also the ac ground reference for the integrated output PLL external loop filter.
33	LF_VCO2	I/O	Loop filter	Loop Filter Node for the Output PLL. Connect an external 6.8 nF capacitor from this pin to Pin 32 (LDO_VCO2).
34, 36	NC			No Connect. There is no internal connection for this pin.
35	AVDD	I	Power	1.8 V Analog (APLL) Power Supply.
37, 38	AVDD	I	Power	1.8 V Analog (DCO and TDC) Power Supplies.
39	$\overline{\text{RESET}}$	I	3.3 V CMOS	Chip Reset. When this active low pin is asserted, the chip goes into reset. This pin has an internal 50 k Ω pull-up resistor.
40	PINCONTROL	I	3.3 V CMOS	Pin Program Mode Enable Pin. When pulled high during startup, this pin enables pin programming of the AD9558 configuration during startup. If this pin is low during startup, the user must program the device via the serial port, or use values that are stored in the EEPROM.
41	M7	I/O	3.3 V CMOS	Configurable I/O Pin. Along with pins M6 through M0, this pin is configured through the AD9558 register space.
42	$\overline{\text{SYNC}}$	I	3.3 V CMOS	Clock Distribution Synchronization Pin. When this pin is activated, output drivers are held static and then synchronized on a low-to-high transition of this pin. This pin is used to arm the frame sync function when frame sync mode is enabled. This pin has an internal 60 k Ω pull-up resistor.

Pin No.	Mnemonic	Input/ Output	Pin Type	Description
43	REFA	I	Differential input	Reference A Input. This internally biased input is typically ac-coupled and, when configured as such, can accept any differential signal with single-ended swing up to 3.3 V. If dc-coupled, the input can be LVPECL, LVDS, or single-ended CMOS.
44	$\overline{\text{REFA}}$	I	Differential input	Complementary Reference A Input. This pin is the complementary input to Pin 43.
45, 46, 51, 52	DVDD3	I	Power	3.3 V Digital (Reference Input) Power Supply.
47	REFC	I	Differential input	Reference C Input. This internally biased input is typically ac-coupled and, when configured as such, can accept any differential signal with single-ended swing up to 3.3 V. If dc-coupled, the input can be LVPECL, LVDS, or single-ended CMOS.
48	$\overline{\text{REFC}}$	I	Differential input	Complementary Reference C Input. This pin is the complementary input to Pin 47.
49	REFD	I	Differential input	Reference D Input. This internally biased input is typically ac-coupled and, when configured as such, can accept any differential signal with single-ended swing up to 3.3 V. If dc-coupled, the input can be LVPECL, LVDS, or single-ended CMOS.
50	$\overline{\text{REFD}}$	I	Differential input	Complementary Reference D Input. This pin is the complementary input to Pin 49.
53	REFB	I	Differential input	Reference B Input. This internally biased input is typically ac-coupled and, when configured as such, can accept any differential signal with single-ended swing up to 3.3 V. If dc-coupled, the input can be LVPECL, LVDS, or single-ended CMOS.
54	$\overline{\text{REFB}}$	I	Differential input	Complementary Reference B Input. This pin is the complementary input to Pin 53.
57, 58, 59, 60, 61, 62, 63	M0, M1, M2, M3, M4, M5, M6	I/O	3.3 V CMOS	Configurable I/O Pins. These pins are configured through the AD9558 register space. The M7 pin (Pin 41) is the last pin of this group.
64	DVDD3 EP	I O	Power Exposed pad	3.3 V Digital Supply. The exposed pad must be connected to ground (VSS).

TYPICAL PERFORMANCE CHARACTERISTICS

f_R = input reference clock frequency; f_{OUT} = output clock frequency; f_{SYS} = SYSCLK input frequency; f_S = internal system clock frequency; LF = SYSCLK PLL internal loop filter used. AVDD, AVDD3, and DVDD at nominal supply voltage; f_S = 786.432 MHz, unless otherwise noted.

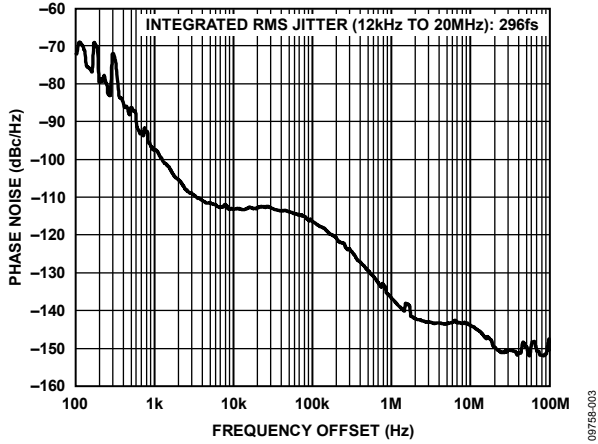

Figure 3. Absolute Phase Noise (Output Driver = HSTL),
 $f_R = 19.44$ MHz, $f_{OUT} = 622.08$ MHz,
 DPLL Loop BW = 50 Hz, $f_{SYS} = 49.152$ MHz Crystal

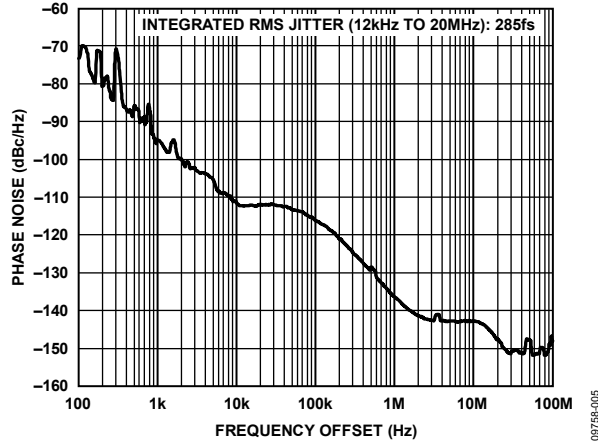

Figure 5. Absolute Phase Noise (Output Driver = HSTL),
 $f_R = 19.44$ MHz, $f_{OUT} = 693.482991$ MHz,
 DPLL Loop BW = 50 Hz, $f_{SYS} = 49.152$ MHz Crystal

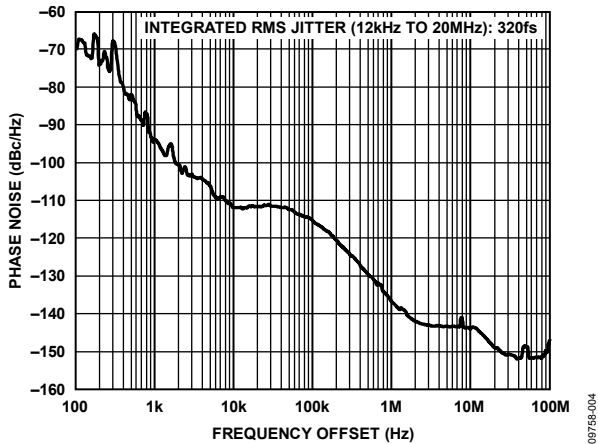

Figure 4. Absolute Phase Noise (Output Driver = HSTL),
 $f_R = 19.44$ MHz, $f_{OUT} = 644.53125$ MHz,
 DPLL Loop BW = 50 Hz, $f_{SYS} = 49.152$ MHz Crystal

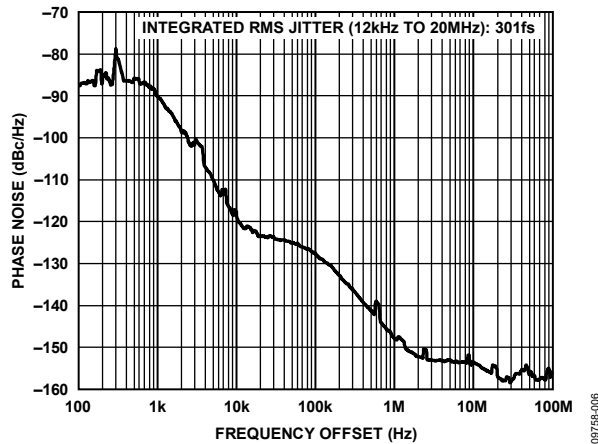
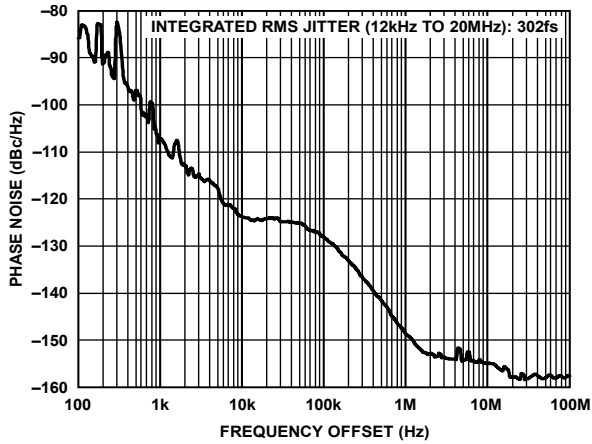
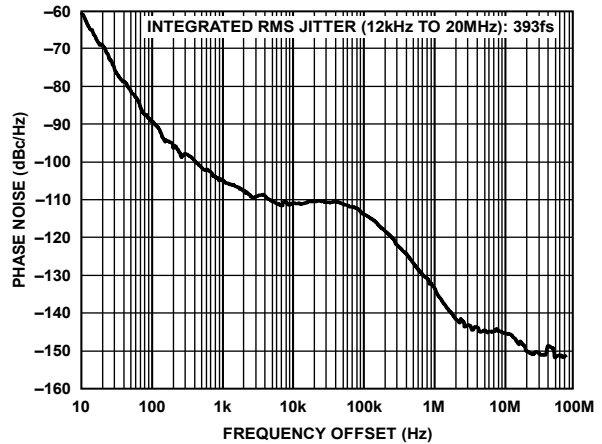

Figure 6. Absolute Phase Noise (Output Driver = HSTL),
 $f_R = 19.44$ MHz, $f_{OUT} = 174.703$ MHz,
 DPLL Loop BW = 1 kHz, $f_{SYS} = 49.152$ MHz Crystal



09758-007

Figure 7. Absolute Phase Noise (Output Driver = 3.3V CMOS),
 $f_R = 19.44$ MHz, $f_{OUT} = 161.1328125$ MHz,
 DPLL Loop BW = 100 Hz, $f_{SYS} = 49.152$ MHz Crystal



09758-010

Figure 10. Absolute Phase Noise (Output Driver = HSTL),
 $f_R = 19.44$ MHz, $f_{OUT} = 644.53$ MHz,
 DPLL Loop BW = 0.1 Hz, $f_{SYS} = 19.2$ MHz TCXO

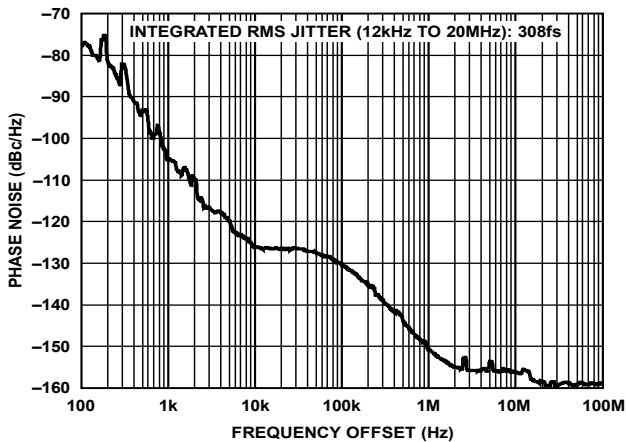

09758-008

Figure 8. Absolute Phase Noise (Output Driver = HSTL),
 $f_R = 2$ kHz, $f_{OUT} = 125$ MHz,
 DPLL Loop BW = 100 Hz, $f_{SYS} = 49.152$ MHz Crystal

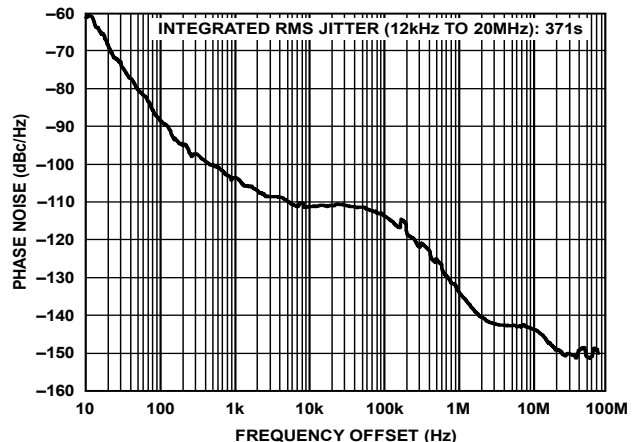

09758-011

Figure 11. Absolute Phase Noise (Output Driver = HSTL),
 $f_R = 19.44$ MHz, $f_{OUT} = 693.482991$ MHz,
 DPLL Loop BW = 0.1 Hz, $f_{SYS} = 19.2$ MHz TCXO

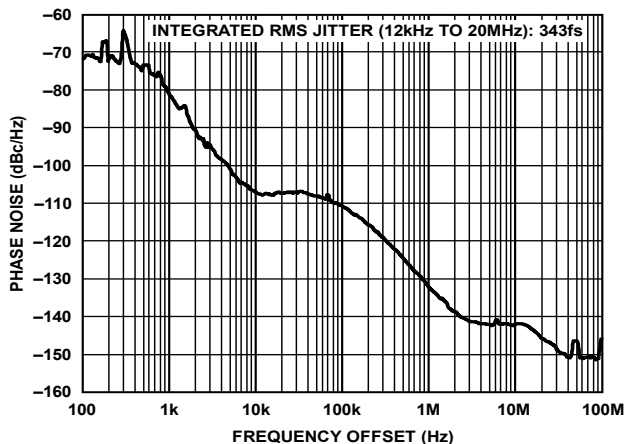

09758-009

Figure 9. Absolute Phase Noise (Output Driver = HSTL),
 $f_R = 25$ MHz, $f_{OUT} = 1$ GHz,
 DPLL Loop BW = 500 Hz, $f_{SYS} = 49.152$ MHz Crystal

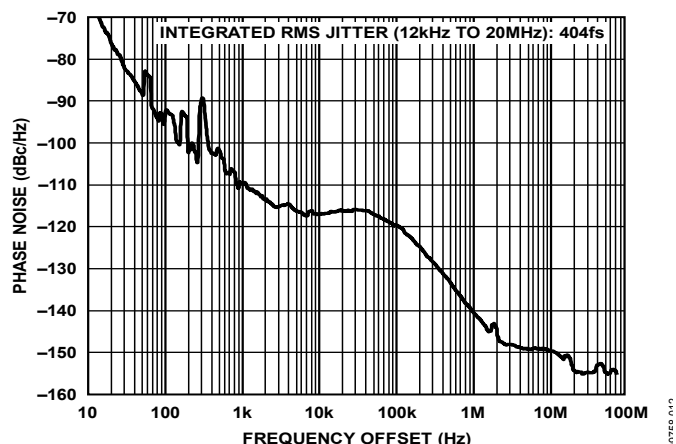

09758-012

Figure 12. Absolute Phase Noise (Output Driver = HSTL),
 $f_R = 19.44$ MHz, $f_{OUT} = 312.5$ MHz,
 DPLL Loop BW = 0.1 Hz, $f_{SYS} = 19.2$ MHz TCXO

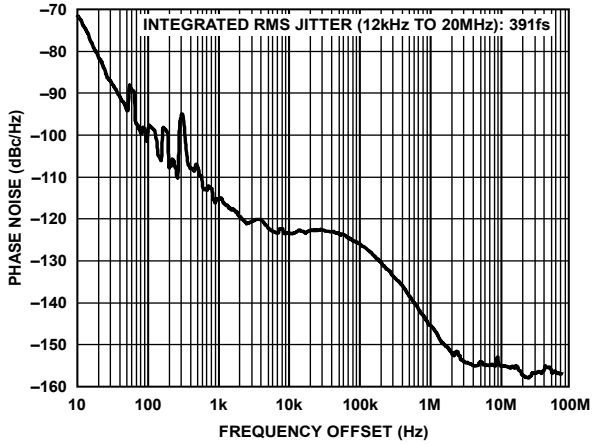

09758-013

Figure 13. Absolute Phase Noise (Output Driver = 3.3 V CMOS), $f_R = 19.44$ MHz, $f_{OUT} = 161.1328125$ MHz, DPLL Loop BW = 0.1 Hz, $f_{SYS} = 19.2$ MHz TCXO

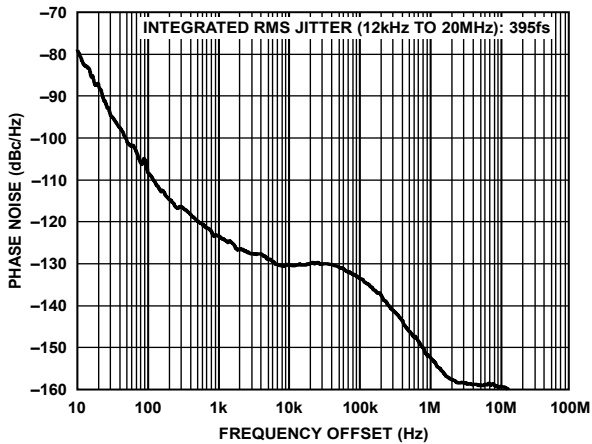

09758-014

Figure 14. Absolute Phase Noise (Output Driver = 1.8 V CMOS), $f_R = 2$ kHz, $f_{OUT} = 70.656$ MHz, DPLL Loop BW = 0.1 Hz, $f_{SYS} = 19.2$ MHz TCXO

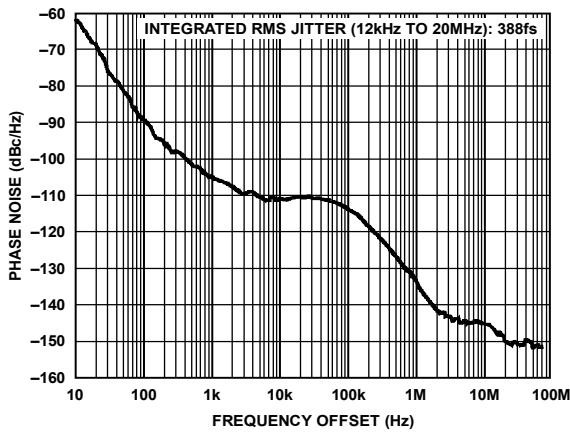

09758-016

Figure 15. Absolute Phase Noise (Output Driver = HSTL), $f_R = 19.44$ MHz, $f_{OUT} = 644.53$ MHz, $f_{SYS} = 19.2$ MHz TCXO Holdover Mode

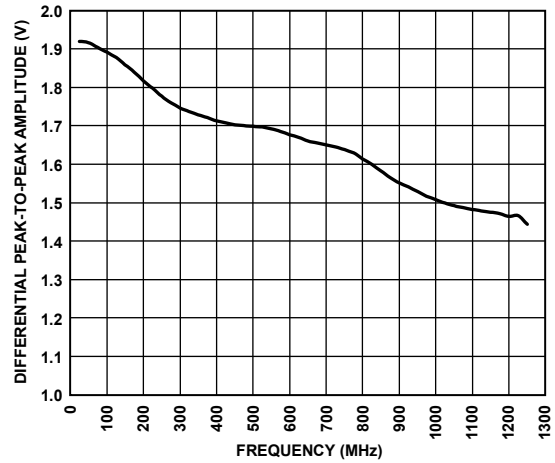

09758-116

Figure 16. Amplitude vs. Toggle Rate, HSTL Mode (LVPECL-Compatible Mode)

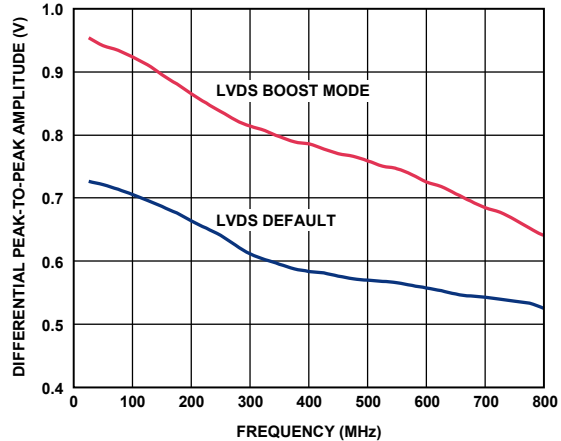

09758-117

Figure 17. Amplitude vs. Toggle Rate, LVDS

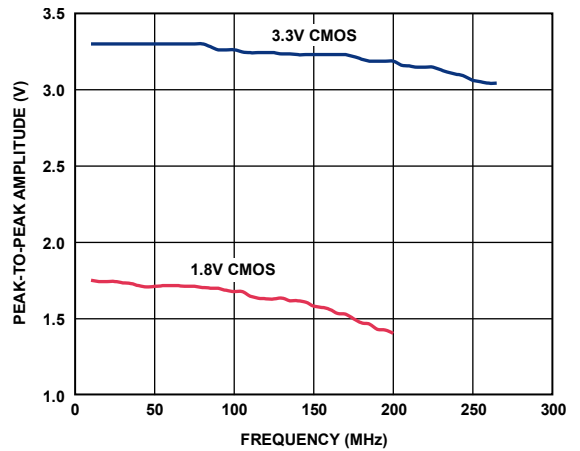

09758-118

Figure 18. Amplitude vs. Toggle Rate with 10 pF Load, 3.3 V (Strong Mode) and 1.8 V CMOS

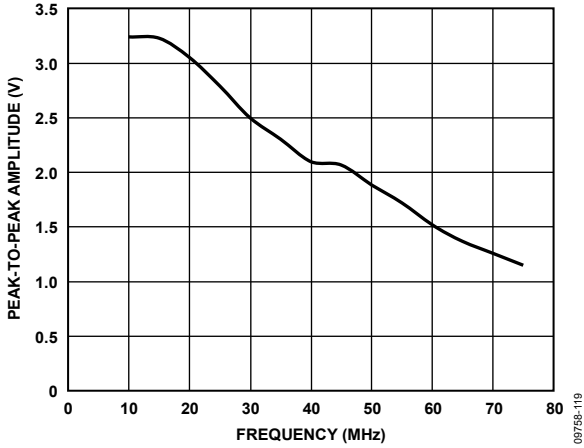

Figure 19. Amplitude vs. Toggle Rate with 10 pF Load, 3.3 V (Weak Mode) CMOS

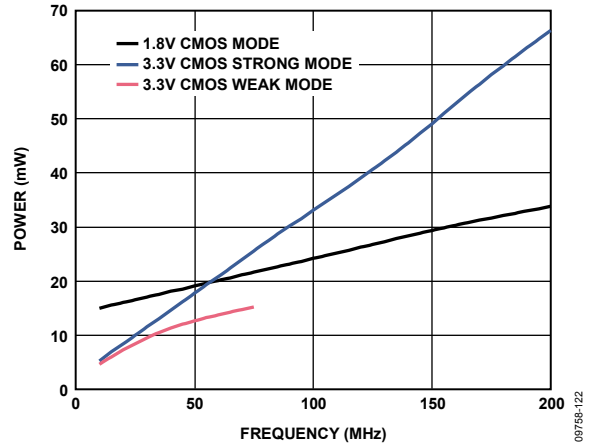

Figure 22. Power Consumption vs. Frequency, One CMOS Driver on Output Driver Power Supply Only (Pin 12, Pin 17, Pin 22, and Pin 29) for 1.8 V CMOS Mode, or on Pin 25 and Pin 26 for 3.3 V CMOS Mode

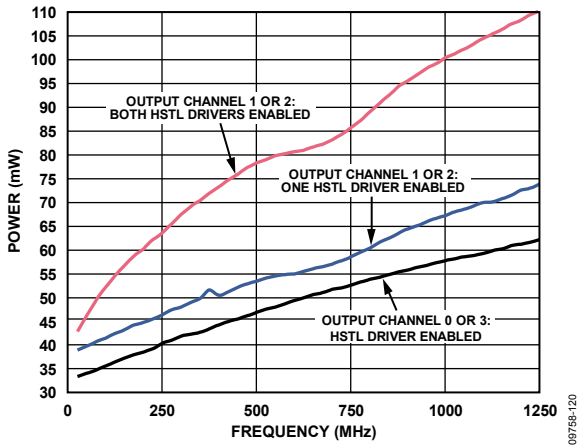

Figure 20. Power Consumption vs. Frequency, HSTL Mode (Single Channel) on 1.8 V Output Driver Power Supply Only (Pin 12, Pin 17, Pin 22, and Pin 29)

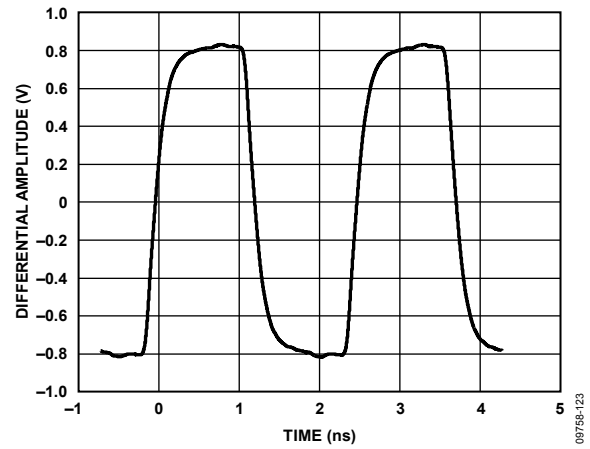

Figure 23. Output Waveform, HSTL (400 MHz)

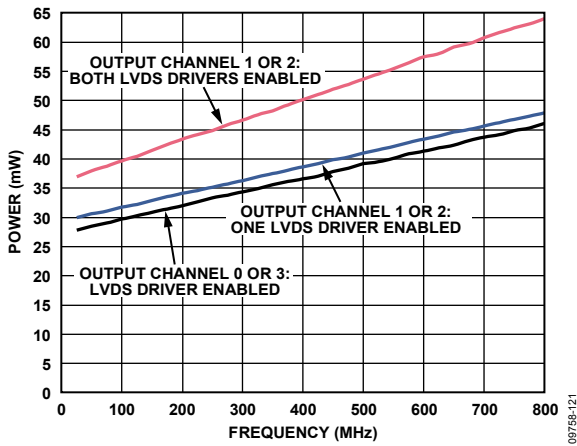

Figure 21. LVDS Power Consumption vs. Frequency on 1.8 V Output Driver Power Supply Only (Pin 12, Pin 17, Pin 22, and Pin 29)

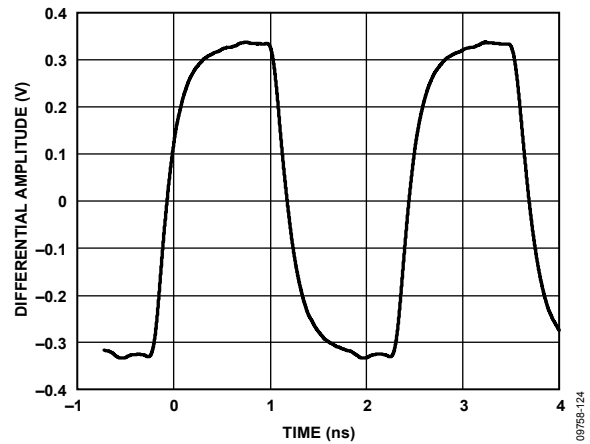

Figure 24. Output Waveform, LVDS (400 MHz)

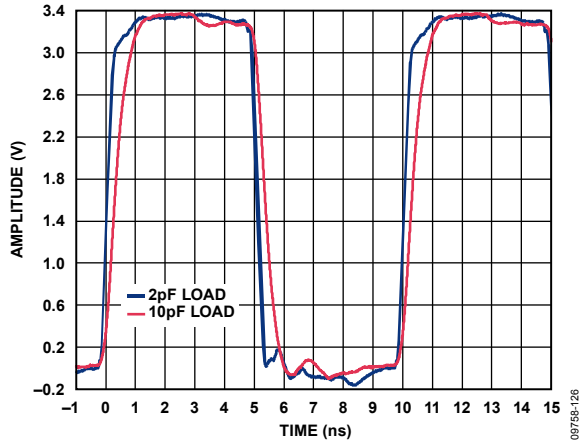

Figure 25. Output Waveform, 3.3 V CMOS (100 MHz, Strong Mode)

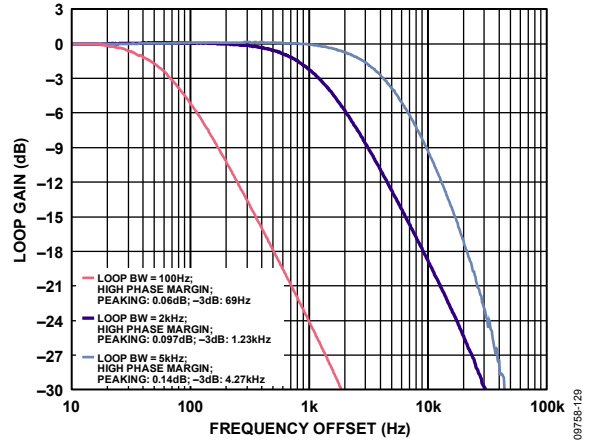

Figure 28. Closed-Loop Transfer Function for 100 Hz, 2 kHz, and 5 kHz Loop Bandwidth Settings; High Phase Margin Loop Filter Setting (Compliant with Telcordia GR-253 Jitter Transfer Test for Loop Bandwidths < 2 kHz)

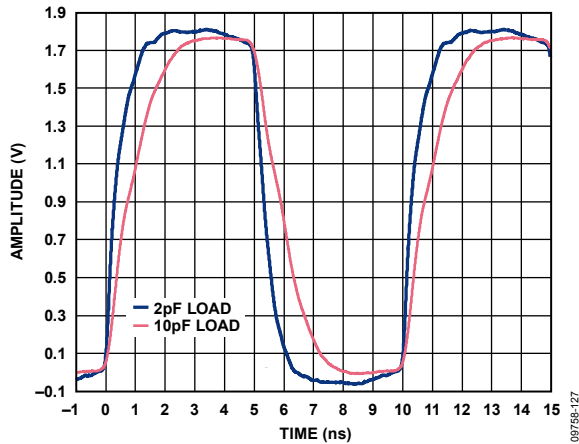

Figure 26. Output Waveform, 1.8 V CMOS (100 MHz)

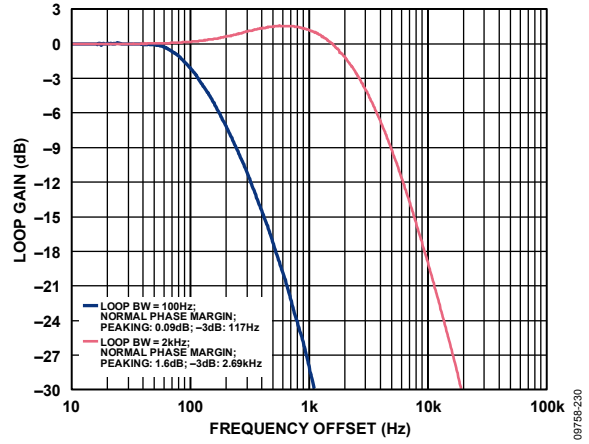

Figure 29. Closed-Loop Transfer Function for 100 Hz and 2 kHz Loop Bandwidth Settings; Normal Phase Margin Loop Filter Setting

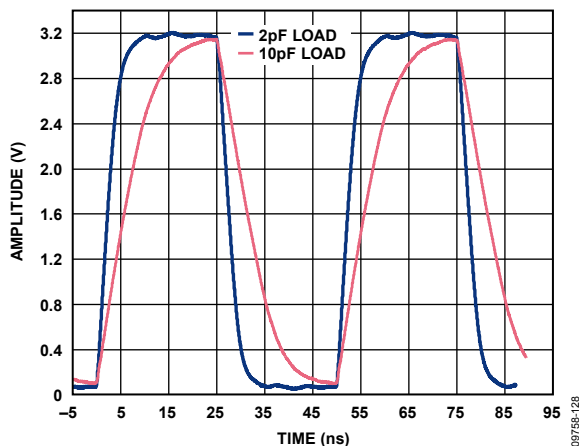

Figure 27. Output Waveform, 3.3 V CMOS (20 MHz, Weak Mode)

INPUT/OUTPUT TERMINATION RECOMMENDATIONS

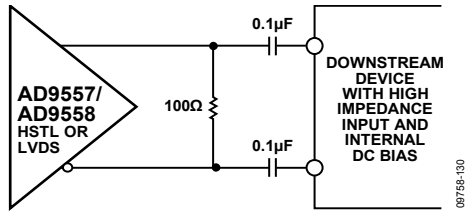

Figure 30. AC-Coupled LVDS or HSTL Output Driver
(100 Ω Resistor Can be Placed on Either Side of Decoupling Capacitors and Must be as Close as Possible to the Destination Receiver)

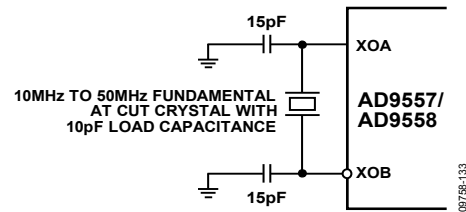

Figure 33. System Clock Input (XOA, XOB) in Crystal Mode
(Recommended $C_{LOAD} = 10\text{ pF}$ is Shown; Values of 15 pF Shunt Capacitors Shown Here Must Equal $2 \times (C_{LOAD} - C_{STRAY})$, Where C_{STRAY} is Typically 2 pF to 5 pF)

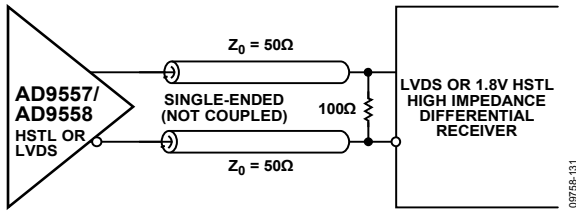

Figure 31. DC-Coupled LVDS or HSTL Output Driver

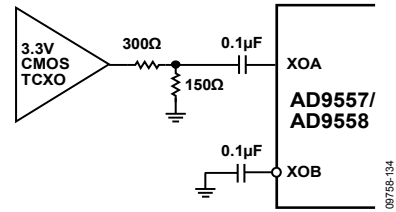

Figure 34. System Clock Input (XOA, XOB) when Using a TCXO/OCXO with 3.3 V CMOS Output

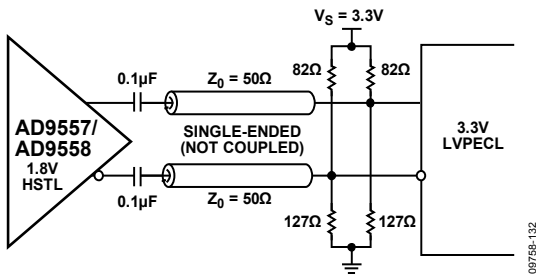

Figure 32. Interfacing the HSTL Driver to a 3.3 V LVPECL Input
(This Method Incorporates Impedance Matching and DC Biasing for Bipolar LVPECL Receivers; if the Receiver is Self-Biased, the Termination Scheme Shown in Figure 30 is Recommended)

GETTING STARTED

CHIP POWER MONITOR AND STARTUP

The AD9558 monitors the voltage on the power supplies at power-up. When DVDD3 is greater than $2.35\text{ V} \pm 0.1\text{ V}$ and DVDD and AVDD are greater than $1.4\text{ V} \pm 0.05\text{ V}$, the device generates a 20 ms reset pulse. The power-up reset pulse is internal and independent of the RESET pin. This internal power-up reset sequence eliminates the need for the user to provide external power supply sequencing. Within 45 ns after the leading edge of the internal reset pulse, the M7 to M0 multifunction pins behave as high impedance digital inputs and continue to do so until programmed otherwise. The delay on the M7 to M0 pin function change is 45 ns for pin reset or soft reset.

During a device reset (either via the power-up reset pulse or the RESET pin), the multifunction pins (M7 to M0) behave as high impedance inputs; however, upon removal of the reset condition, level-sensitive latches capture the logic pattern present on the multifunction pins.

MULTIFUNCTION PINS AT RESET/POWER-UP

The AD9558 requires the user to supply the desired logic state to the PINCONTROL pin, as well as to the M7 to M0 pins. If PINCONTROL is high, the device is in hard pin programming mode. See the Pin Program Function Description section for details on hard pin programming.

At startup, there are three choices for the M7 to M0 pins: pull-up, pull-down, and floating. If the PINCONTROL pin is low, the M7 to M0 pins determine the following configurations:

- Following a reset, the M1 and M0 pins determine whether the serial port interface behaves according to the SPI or I²C protocol. Specifically, M0 = M1 = low selects the SPI interface, and any other value selects the I²C port. The 3-level logic of M1 and M0 allows the user to select eight possible I²C addresses (see Table 24).
- The M3 and M2 pins select which of the eight possible EEPROM profiles are loaded, or if the EEPROM loading is bypassed. Leaving M3 and M2 floating at startup bypasses the EEPROM loading, and the factory defaults are used instead (see Table 22).

DEVICE REGISTER PROGRAMMING USING A REGISTER SETUP FILE

The evaluation software contains a programming wizard and a convenient graphical user interface that assists the user in determining the optimal configuration for the DPLLs, APLLs, and SYSCLK based on the desired input and output frequencies. It generates a register setup file with a .STP extension that is easily readable using a text editor.

After using the evaluation software to create the setup file, see Figure 35, Figure 36, and Figure 37 for the correct sequence to program the AD9558.

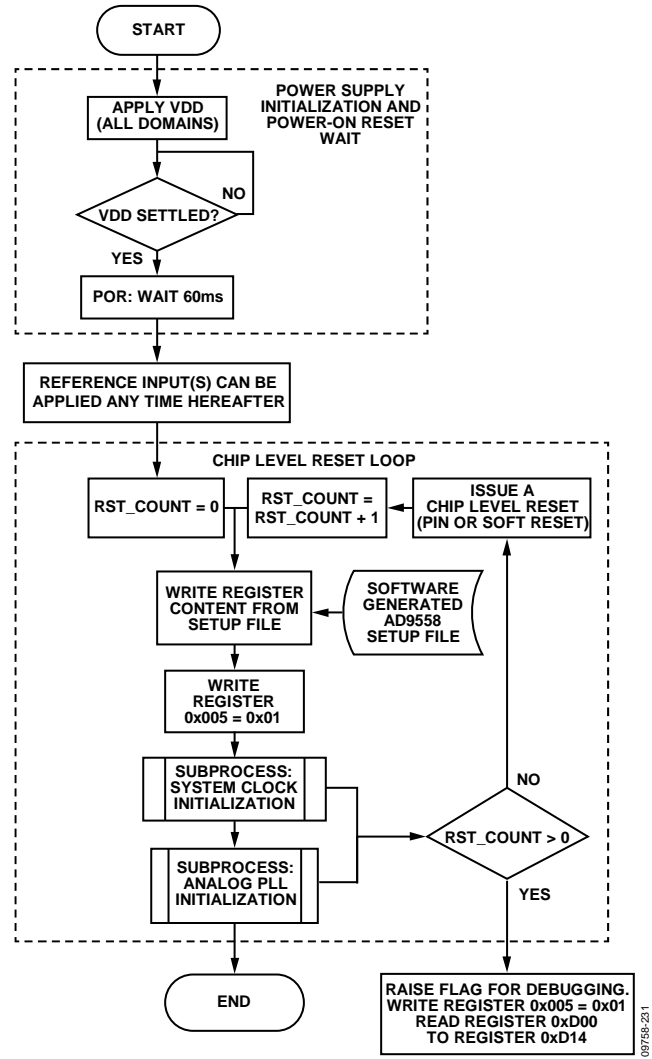
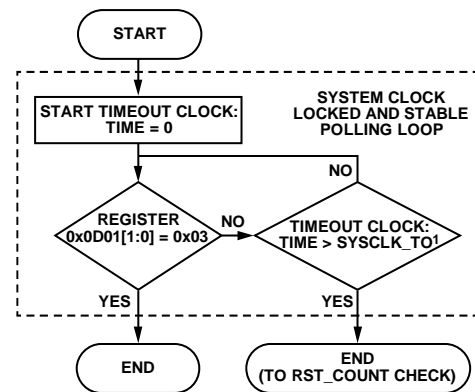

Figure 35. AD9558 Initialization Flowchart



¹SYSCLK_TO IS A CALCULATED VALUE TIMEOUT VALUE. IT IS 100ms + SYSTEM CLOCK VALIDATION TIME (REGISTER 0x0106 TO REGISTER 0x0108: DEFAULT = 50ms).

Figure 36. AD9558 System Clock Initialization Subprocess Flowchart

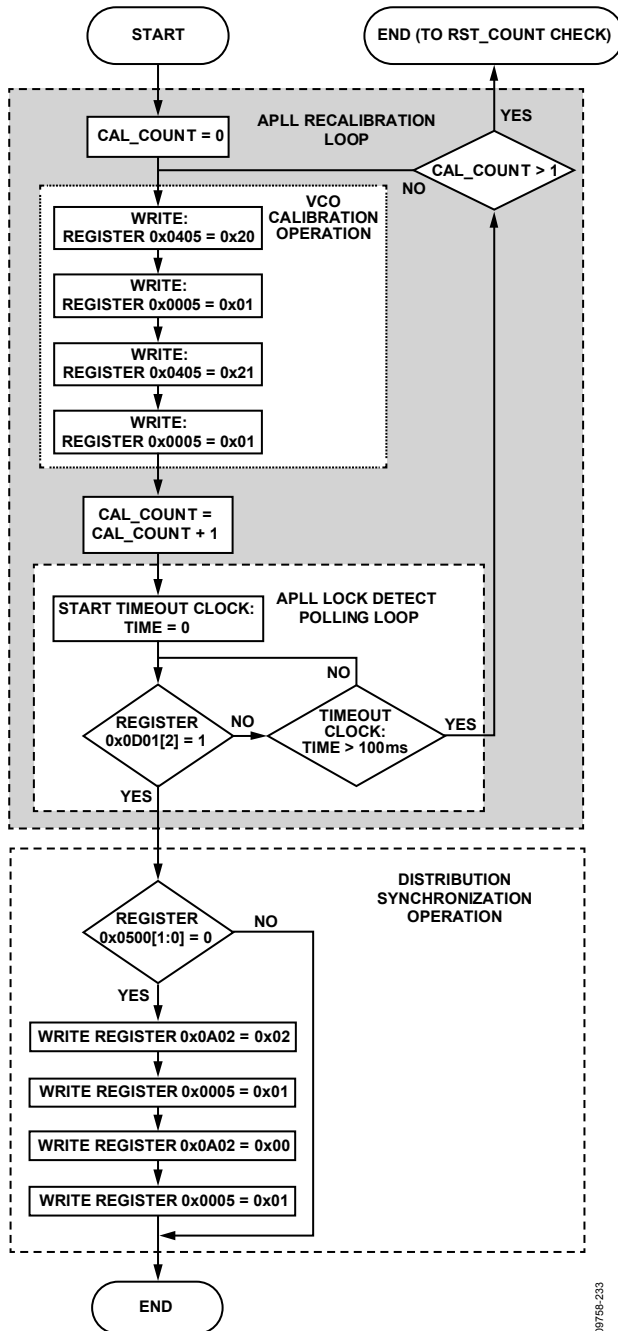

Figure 37. AD9558 APLL Initialization Subprocess Flowchart

REGISTER PROGRAMMING OVERVIEW

This section provides an overview of the register blocks in the AD9558 and describes their functions and importance.

Registers Differing from Defaults for Optimal Performance

Ensure that the following registers are programmed to the listed values for optimal performance:

- Register 0x0405, Bits[7:4] = 0x2
- Register 0x0403 = 0x07
- Register 0x0400 = 0x81

If the silicon revision (Register 0x000A) equals 0x21 or higher, the values listed here are already the default values.

Program the System Clock and Free Run Tuning Word

The system clock multiplier (SYCLK) parameters are at Register 0x0100 to Register 0x0108, and the free run tuning word is at Register 0x0300 to Register 0x0303. Use the following steps for optimal performance:

1. Set the system clock PLL input type and divider values.
2. Set the system clock period.
It is essential to program the system clock period because many of the AD9558 subsystems rely on this value.
3. Set the system clock stability timer.
It is highly recommended that the system clock stability timer be programmed. This is especially important when using the system clock multiplier and also applies when using an external system clock source, especially if the external source is not expected to be completely stable when power is applied to the AD9558. The system clock stability timer specifies the amount of time that the system clock PLL must be locked before the device declares that the system clock is stable. The default value is 50 ms.
4. Program the free run tuning word.
The free run frequency of the digital PLL (DPLL) determines the frequency appearing at the APLL input when free run mode is selected. The free run tuning word is at Register 0x0300 to Register 0x0303. The correct free run frequency is required for the APLL to calibrate and lock correctly.
5. Set user free run mode (Register 0x0A01, Bit 5 = 1b).

009758-233

Initialize and Calibrate the Output PLL (APLL)

The registers controlling the APLL are at Register 0x0400 to Register 0x0408. This low noise, integer-N PLL multiplies the DPLL output (which is usually 175 MHz to 200 MHz) to a frequency in the 3.35 GHz to 4.05 GHz range. After the system clock is configured and the free run tuning word is set in Register 0x0300 to Register 0x0303, the user can set the manual APLL VCO calibration bit (Register 0x0405, Bit 0) and issue an I/O update (Register 0x0005, Bit 0). This process performs the APLL VCO calibration. VCO calibration ensures that, at the time of calibration, the dc control voltage of the APLL VCO is centered in the middle of its operating range. It is important to remember the following points when calibrating the APLL VCO:

- The system clock must be stable.
- The APLL VCO must have the correct frequency from the 30-bit digitally controlled oscillator (DCO) during calibration.
- The APLL VCO must be recalibrated any time the APLL frequency changes.
- APLL VCO calibration occurs on the low-to-high transition of the manual APLL VCO calibration bit, and this bit is not autoclearing. Therefore, this bit must be cleared (and an I/O update issued) before another APLL calibration is started.
- The best way to monitor successful APLL calibration is to monitor Bit 2 in Register 0x0D01 (APLL lock).

Program the Clock Distribution Outputs

The APLL output goes to the clock distribution block. The clock distribution parameters reside in Register 0x0500 to Register 0x0515. They include the following:

- Output power-down control
- Output enable (disabled by default)
- Output synchronization
- Output mode control
- Output divider functionality

See the Clock Distribution section for more information.

Generate the Output Clock

If Register 0x0500, Bits[1:0] is programmed for automatic clock distribution synchronization via the DPLL phase or frequency lock, the synthesized output signal appears at the clock distribution outputs. Otherwise, set and then clear the soft sync clock distribution bit (Register 0x0A02, Bit 1), or use a multifunction pin input (if programmed for use) to generate a clock distribution sync pulse, which causes the synthesized output signal to appear at the clock distribution outputs.

Program the Multifunction Pins (Optional)

This step is required only if the user intends to use any of the multifunction pins for status or control. The multifunction pin parameters are in Register 0x0200 to Register 0x0208.

Program the IRQ Functionality (Optional)

This step is required only if the user intends to use the IRQ feature. The IRQ monitor registers are in Register 0x0D02 to Register 0x0D09. If the desired bits in the IRQ mask registers at Register 0x020A to Register 0x020F are set high, the appropriate IRQ monitor bit at Register 0x0D02 to Register 0x0D07 is set high when the indicated event occurs.

Individual IRQ events are cleared by using the IRQ clearing the registers at Register 0x0A04 to Register 0x0A09, or by setting the clear all IRQs bit (Register 0x0A03, Bit 1) to 1b.

The default values of the IRQ mask registers are such that interrupts are not generated. The IRQ pin mode default is open-drain NMOS.

Program the Watchdog Timer (Optional)

This step is required only if the user intends to use the watchdog timer. The watchdog timer control is in Register 0x0210 and Register 0x0211 and is disabled by default.

The watchdog timer is useful for generating an IRQ after a fixed amount of time. The timer is reset by setting the clear watchdog timer bit (Register 0x0A03, Bit 0) to 1b.

Program the Digital Phase-Locked Loop (DPLL)

The DPLL parameters reside in Register 0x0300 to Register 0x032E. They include the following:

- Free run frequency
- DPLL pull-in range limits
- DPLL closed-loop phase offset
- Phase slew control (for hitless reference switching)
- Tuning word history control (for holdover operation)

Program the Reference Inputs

The reference input parameters reside in Register 0x0600 to Register 0x0602. See the Reference Clock Input section for details on programming these functions. They include the following:

- Reference power-down
- Reference logic family
- Reference priority

Program the Reference Profiles

The reference profile parameters reside in Register 0x0700 to Register 0x07E6. The [AD9558](#) evaluation software contains a wizard that calculates these values based on the user input frequency. See the Reference Profiles section for details on programming these functions. They include the following:

- Reference period
- Reference period tolerance
- Reference validation timer
- Selection of high phase margin loop filter coefficients
- DPLL loop bandwidth
- Reference prescaler (R divider)
- Feedback dividers (N1, N2, N3, FRAC1, and MOD1)
- Phase and frequency lock detector controls

Generate the Reference Acquisition

After the registers are programmed, the user can clear the user free run bit (Register 0x0A01, Bit 5) and issue an I/O update, using Register 0x0005, Bit 0, to invoke all of the register settings that are programmed up to this point.

After the registers are programmed, the DPLL locks to the first available valid reference that has the highest priority.

THEORY OF OPERATION

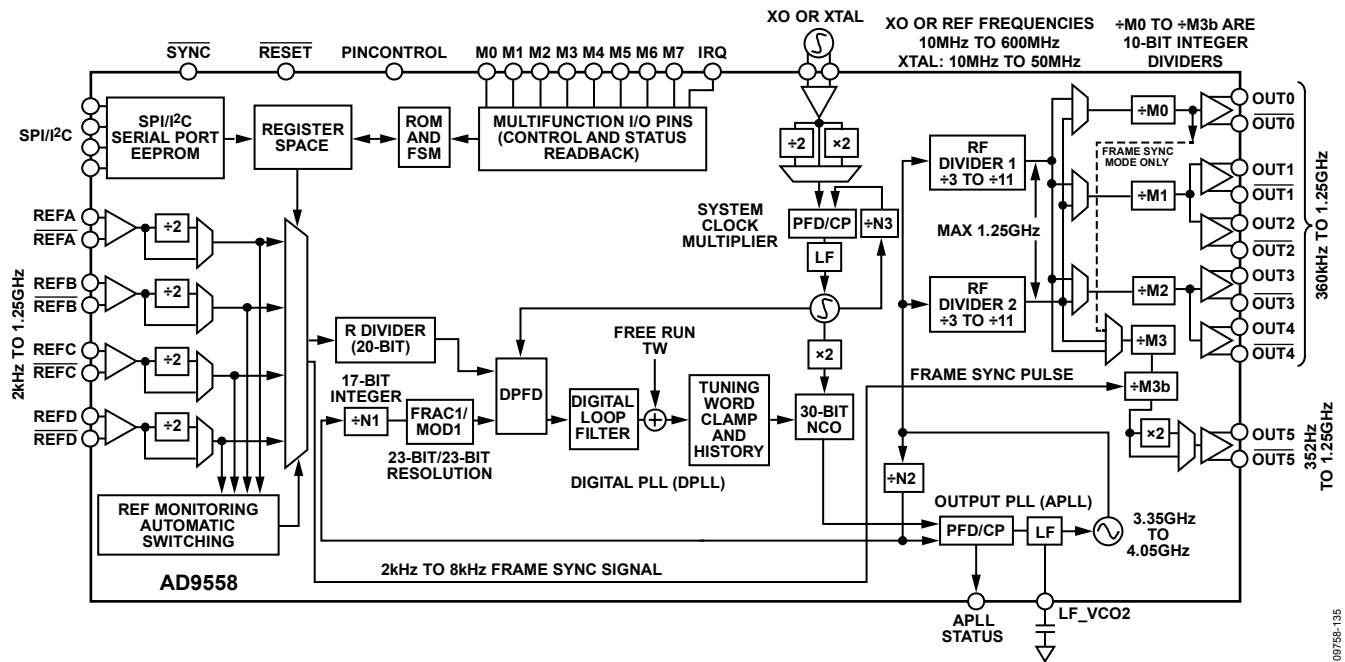

Figure 38. Detailed Block Diagram

OVERVIEW

The [AD9558](#) provides clocking outputs that are directly related in phase and frequency to the selected (active) reference, but with jitter characteristics that are governed by the system clock, the DCO, and the analog integer-N PLL (APLL). The [AD9558](#) supports up to four reference inputs and input frequencies ranging from 2 kHz to 1250 MHz. The core of this product is a digital phase-locked loop (DPLL). The DPLL has a programmable digital loop filter that greatly reduces jitter that is transferred from the active reference to the output. The [AD9558](#) supports both manual and automatic holdover. While in holdover, the [AD9558](#) continues to provide an output as long as the system clock is present. The holdover output frequency is a time average of the output frequency history just prior to the transition to the holdover condition. The device offers manual and automatic reference switchover capability if the active reference is degraded or fails completely. The [AD9558](#) also has adaptive clocking capability that allows the DPLL divider ratios to be changed while the DPLL is locked.

The [AD9558](#) has a system clock multiplier, a DPLL, and an APLL. The input signal goes first to the DPLL, which performs the jitter cleaning and most of the frequency translation. The DPLL features a 30-bit digitally controlled oscillator (DCO) output that generates a signal in the 175 MHz to 200 MHz range. The DPLL output goes to an APLL, which multiplies the signal up to the 3.35 GHz to 4.05 GHz range. That signal is then sent to the clock distribution section, which has two divide-by-3 to divide-by-11 RF dividers that are cascaded with 10-bit integer (divide-by-1 to divide-by-1024) channel dividers.

The XOA and XOB pins provide the input for the system clock. These pins accept a reference clock in the 10 MHz to 600 MHz range, or a 10 MHz to 50 MHz crystal connected directly across the XOA and XOB pins. The system clock provides the clocks to the frequency monitors, the DPLL, and internal switching logic.

The [AD9558](#) has six output drivers, arranged into four channels. Each channel has a dedicated 10-bit programmable post divider. Channel 0 and Channel 3 have one driver each, and Channel 1 and Channel 2 have two drivers each. Each driver is programmable either as a single differential or dual single-ended CMOS output. The clock distribution section operates at up to 1250 MHz.

In differential mode, the output drivers run on a 1.8 V power supply to offer very high performance with minimal power consumption. There are two differential modes: LVDS and 1.8 V HSTL. In 1.8 V HSTL mode, the voltage swing is compatible with LVPECL. If LVPECL signal levels are required, the designer can ac couple the [AD9558](#) output and use Thevenin-equivalent termination at the destination to drive the LVPECL inputs.

In single-ended mode, each differential output driver can operate as two single-ended CMOS outputs. OUT0 and OUT5 support either 1.8 V or 3.3 V CMOS operation. OUT1 through OUT4 support only 1.8 V operation.

Note that the APLL is also referred to as the output PLL elsewhere in this data sheet.

REFERENCE CLOCK INPUTS

Four pairs of pins provide access to the reference clock receivers. To accommodate input signals with slow rising and falling edges, both the differential and single-ended input receivers employ hysteresis. Hysteresis also ensures that a disconnected or floating input does not cause the receiver to oscillate.

When configured for differential operation, the input receivers accommodate either ac- or dc-coupled input signals. The input receivers are capable of accepting dc-coupled LVDS and 2.5 V and 3.3 V LVPECL signals. The receiver is internally dc biased to handle ac-coupled operation, but there is no internal 50 Ω or 100 Ω termination.

When configured for single-ended operation, the input receivers exhibit a pull-down load of 45 k Ω (typical). Three user-programmable threshold voltage ranges are available for each single-ended receiver.

REFERENCE MONITORS

The accuracy of the input reference monitors depends on a known and accurate system clock period. Therefore, the functioning of the reference monitors is not operable until the system clock is stable.

Reference Period Monitor

Each reference input has a dedicated monitor that repeatedly measures the reference period. The AD9558 uses the reference period measurements to determine the validity of the reference based on a set of user-provided parameters in the profile register area of the register map.

The monitor works by comparing the measured period of a particular reference input with the parameters stored in the profile register assigned to that same reference input. The parameters include the reference period, an inner tolerance, and an outer tolerance. A 40-bit number defines the reference period in units of femtoseconds (fs). The 40-bit range allows a reference period entry of up to 1.1 ms. A 20-bit number defines the inner and outer tolerances. The value stored in the register is the reciprocal of the tolerance specification. For example, a tolerance specification of 50 ppm yields a register value of $1/(50 \text{ ppm}) = 1/0.000050 = 20,000$ (0x04E20).

The use of two tolerance values provides hysteresis for the monitor decision logic. The inner tolerance applies to a previously faulted reference and specifies the largest period tolerance that a previously faulted reference can exhibit before it qualifies as nonfaulted. The outer tolerance applies to an already nonfaulted reference. It specifies the largest period tolerance that a nonfaulted reference can exhibit before being faulted.

To produce decision hysteresis, the inner tolerance must be less than the outer tolerance. That is, a faulted reference must meet tighter requirements to become nonfaulted than a nonfaulted reference must meet to become faulted.

Reference Validation Timer

Each reference input has a dedicated validation timer. The validation timer establishes the amount of time that a previously faulted reference must remain unfaulted before the AD9558 declares it valid. The timeout period of the validation timer is programmable via a 16-bit register. The 16-bit number stored in the validation register represents units of milliseconds (ms), which yields a maximum timeout period of 65,535 ms.

It is possible to disable the validation timer by programming the validation timer to 0b. With the validation timer disabled, the user must validate a reference manually via the manual reference validation override controls register (Address 0x0A0B).

Reference Validation Override Control

The user also has the ability to override the reference validation logic and can either force an invalid reference to be treated as valid, or force a valid reference to be treated as an invalid reference. These controls are in Register 0x0A0B to Register 0x0A0D.

REFERENCE PROFILES

The AD9558 has an independent profile for each reference input. A profile consists of a set of device parameters such as the R divider and N divider, among others. The profiles allow the user to prescribe the specific device functionality that takes effect when one of the input references becomes the active reference.

The AD9558 evaluation software includes a frequency planning wizard that can configure the profile parameters, given the input and output frequencies.

Do not change a profile that is currently in use because unpredictable behavior may result. The user can either select free run or holdover mode or invalidate the reference input prior to changing it.

REFERENCE SWITCHOVER

An attractive feature of the AD9558 is its versatile reference switchover capability. The flexibility of the reference switchover functionality resides in a sophisticated prioritization algorithm that is coupled with register-based controls. This scheme provides the user with maximum control over the state machine that handles reference switchover.

The main reference switchover control resides in the loop mode register (Address 0x0A01). The REF switchover mode bits (Register 0x0A01, Bits[4:2]) allow the user to select one of the five operating modes of the reference switchover state machine, as follows:

- Automatic revertive mode
- Automatic nonrevertive mode
- Manual with automatic fallback mode
- Manual with holdover mode
- Full manual mode (without automatic holdover)

In the automatic modes, a fully automatic priority-based algorithm selects which reference is the active reference. When programmed for an automatic mode, the device chooses the highest priority valid reference. When both references have the same priority, REFA gets preference over REFB. However, the reference position is used only as a tie-breaker and does not initiate a reference switch.

The following list gives an overview of the five operating modes:

- Automatic revertive mode. The device selects the highest priority valid reference and switches to a higher priority reference if it becomes available, even if the reference in use is still valid. In this mode, the user reference is ignored.
- Automatic non-revertive mode. The device stays with the currently selected reference as long as it is valid, even if a higher priority reference becomes available. The user reference is ignored in this mode.
- Manual with automatic fallback mode. The device uses the user reference for as long as it is valid. If it becomes invalid, the reference input with the highest priority is chosen in accordance with the priority-based algorithm.
- Manual with holdover mode. The user reference is the active reference until it becomes invalid. At that point, the device automatically goes into holdover.
- Manual mode without holdover. The user reference is the active reference, regardless of whether or not it is valid.

The user also has the option to force the device directly into holdover or free run operation via the user holdover and user free run bits. In free run mode, the free run frequency tuning word register defines the free run output frequency. In holdover mode, the output frequency depends on the holdover control settings (see the Holdover section).

Phase Build-Out Reference Switching

The AD9558 supports phase build-out reference switching, which is the term given to a reference switchover that completely masks any phase difference between the previous reference and the new reference. That is, there is virtually no phase change detectable at the output when a phase build-out switchover occurs.

DIGITAL PLL (DPLL) CORE

DPLL Overview

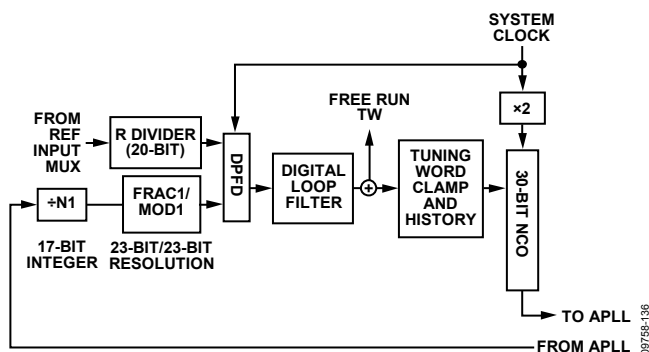

Figure 39. Digital PLL Core

A diagram of the DPLL core of the AD9558 appears in Figure 39. The phase/frequency detector, feedback path, lock detectors, phase offset, and phase slew rate limiting that comprise this second generation DPLL are all digital implementations.

The start of the DPLL signal chain is the reference signal, f_R , which is the frequency of the reference input. A reference prescaler reduces the frequency of this signal by an integer factor, $R + 1$, where R is the 20-bit value stored in the appropriate profile register and $0 \leq R \leq 1,048,575$. Therefore, the frequency at the output of the R -divider (or the input to the time-to-digital converter (TDC)) is

$$f_{TDC} = \frac{f_R}{R + 1}$$

A TDC samples the output of the R -divider. The TDC/PFD produces a time series of digital words and delivers them to the digital loop filter. The digital loop filter offers the following advantages:

- Determination of the filter response by numeric coefficients rather than by discrete component values
- The absence of analog components ($R/L/C$), which eliminates tolerance variations due to aging
- The absence of thermal noise associated with analog components
- The absence of control node leakage current associated with analog components (a source of reference feed-through spurs in the output spectrum of a traditional analog PLL)

The digital loop filter produces a time series of digital words at its output and delivers them to the frequency tuning input of a Σ - Δ modulator (SDM). The digital words from the loop filter steer the DCO frequency toward frequency and phase lock with the input signal (f_{TDC}).

The DPLL includes a feedback divider that causes the digital loop to operate at an integer-plus-fractional multiple. The output of the DPLL is

$$f_{OUT_DPLL} = f_{TDC} \times \left[(NI + 1) + \frac{FRAC1}{MOD1} \right]$$

where:

NI is the 17-bit value stored in the appropriate profile registers (Register 0x0715 to Register 0x0717 for REFA). $FRAC1$ and $MOD1$ are the 23-bit numerators and denominators of the fractional feedback divider block.

The fractional portion of the feedback divider can be bypassed by setting $FRAC1$ to 0, but $MOD1$ must never be 0.

The DPLL output frequency is usually 175 MHz to 200 MHz for optimal performance.

TDC/PFD

The phase-frequency detector (PFD) is an all-digital block. It compares the digital output from the TDC (which relates to the active reference edge) with the digital word from the feedback block. It uses a digital code pump and digital integrator (rather than a conventional charge pump and capacitor) to generate the error signal that steers the DCO frequency toward phase lock.

Programmable Digital Loop Filter

The AD9558 loop filter is a third-order digital IIR filter that is analogous to the third-order analog loop shown in Figure 40.

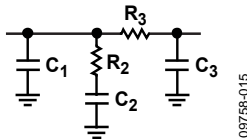

Figure 40. Third-Order Analog Loop Filter

The AD9558 loop filter block features a simplified architecture in which the user enters the desired loop characteristics directly into the profile registers. This architecture makes the calculation of individual coefficients unnecessary in most cases, while still offering complete flexibility.

The AD9558 has two preset digital loop filters: high (88.5°) phase margin and normal (70°) phase margin. The loop filter coefficients are stored in Register 0x0317 to Register 0x0322 for high phase margin and Register 0x0323 to Register 0x032E for normal phase margin. The high phase margin loop filter is intended for applications in which the closed-loop transfer function must not have greater than 0.1 dB of peaking.

Bit 0 of the following registers selects which filter is used for each profile: Register 0x070E for Profile A, Register 0x074E for Profile B, Register 0x078E for Profile C, and Register 0x07CE for Profile D.

The loop bandwidth for each profile is set in the following registers: Register 0x070F to Register 0x0711 for Profile A, Register 0x074F to Register 0x0751 for Profile B, Register 0x078F to Register 0x0791 for Profile C, and Register 0x07CF to Register 0x07D1 for Profile D.

The two preset conditions cover all of the intended applications for the AD9558. For special cases where these conditions must be modified, the tools for calculating these coefficients are available by contacting Analog Devices directly.

DPLL Digitally Controlled Oscillator Free Run Frequency

The AD9558 uses an SDM as a DCO. The DCO free run frequency can be calculated from the following equation:

$$f_{DCO_FREERUN} = f_{SYS} \times \frac{2}{8 + \frac{FTW0}{2^{30}}}$$

where:

$FTW0$ is the value in Register 0x0300 to Register 0x0303.

f_{SYS} is the system clock frequency.

See the System Clock section for information on calculating the system clock frequency.

Adaptive Clocking

The AD9558 can support adaptive clocking applications such as asynchronous mapping and demapping. In these applications, the output frequency can be dynamically adjusted by up to ± 100 ppm from the nominal output frequency without manually breaking the DPLL loop and reprogramming the device. This function is supported for REFA only, not REF B.

The following registers are used in this function:

- Register 0x0715 to Register 0x0717 (DPLL N1 divider)
- Register 0x0718 to Register 0x071A (DPLL FRAC1 divider)
- Register 0x071B to Register 0x071D (DPLL MOD1 divider)

Writing to these registers requires an I/O update by writing 0x01 to Register 0x0005 before the new values take effect.

To make small adjustments to the output frequency, the user can vary the FRAC1 and issue an I/O update. The advantage to using only FRAC1 to adjust the output frequency is that the DPLL does not briefly enter holdover. Therefore, the FRAC1 bit can be updated as fast as the phase detector frequency of the DPLL.

Writing to the N1 and MOD1 dividers allows larger changes to the output frequency. When the AD9558 detects that the N1 or MOD1 values have changed, it automatically enters and exits holdover for a brief instant without any disturbance in the output frequency. This limits how quickly the output frequency can be adapted.

It is important to realize that the amount of frequency adjustment is limited to ± 100 ppm before the output PLL (APLL) needs a recalibration. Variations that are larger than ± 100 ppm are possible; however, the ability of the AD9558 to maintain lock over temperature extremes may be compromised.

It is also important to remember that the rate of change in output frequency depends on the DPLL loop bandwidth.

DPLL Phase Lock Detector

The DPLL contains an all-digital phase lock detector. The user controls the threshold sensitivity and hysteresis of the phase detector via the profile registers.

The phase lock detector behaves in a manner analogous to water in a tub (see Figure 41). The total capacity of the tub is 4096 units with -2048 denoting empty, 0 denoting the 50% point, and $+2048$ denoting full. The tub also has a safeguard to prevent overflow. Furthermore, the tub has a low water mark at -1024 and a high water mark at $+1024$. To change the water level, the user adds water with a fill bucket or removes water with a drain bucket. The user specifies the size of the fill and drain buckets via the 8-bit fill rate and drain rate values in the profile registers.

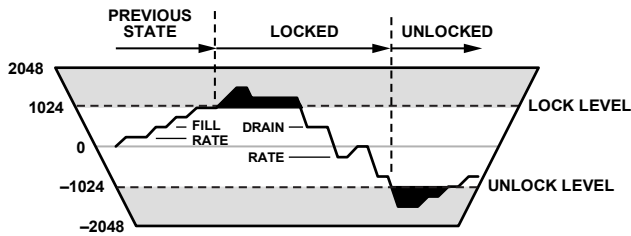

Figure 41. Lock Detector Diagram

The water level in the tub is what the lock detector uses to determine the lock and unlock conditions. When the water level is below the low water mark (-1024), the detector indicates an unlock condition. Conversely, when the water level is above the high water mark ($+1024$), the detector indicates a lock condition. When the water level is between the marks, the detector simply holds its last condition. This concept appears graphically in Figure 41, with an overlay of an example of the instantaneous water level (vertical) vs. time (horizontal) and the resulting lock/unlock states.

During any given PFD cycle, the detector either adds water with the fill bucket or removes water with the drain bucket (one or the other but not both). The decision of whether to add or remove water depends on the threshold level specified by the user. The phase lock threshold value is a 16-bit number stored in the profile registers and is expressed in picoseconds (ps). Thus, the phase lock threshold extends from 0 ns to ± 65.535 ns and represents the magnitude of the phase error at the output of the PFD.

The phase lock detector compares each phase error sample at the output of the PFD to the programmed phase threshold value. If the absolute value of the phase error sample is less than or equal to the programmed phase threshold value, the detector control logic dumps one fill bucket into the tub. Otherwise,

it removes one drain bucket from the tub. Note that it is not the polarity of the phase error sample, but its magnitude relative to the phase threshold value, that determines whether to fill or drain. If more filling is taking place than draining, the water level in the tub eventually rises above the high water mark ($+1024$), which causes the phase lock detector to indicate lock. If more draining is taking place than filling, the water level in the tub eventually falls below the low water mark (-1024), which causes the phase lock detector to indicate unlock. The ability to specify the threshold level, fill rate, and drain rate enables the user to tailor the operation of the phase lock detector to the statistics of the timing jitter associated with the input reference signal.

Note that when the AD9558 enters the free run or holdover mode, the DPLL phase lock detector indicates an unlocked state. However, when the AD9558 performs a reference switch, the lock detector state prior to the switch is preserved during the transition period.

DPLL Frequency Lock Detector

The operation of the frequency lock detector is identical to that of the phase lock detector. The only difference is that the fill or drain decision is based on the period deviation between the reference and feedback signals of the DPLL instead of the phase error at the output of the PFD.

The frequency lock detector uses a 24-bit frequency threshold register specified in units of picoseconds (ps). Therefore, the frequency threshold value extends from 0 μ s to ± 16.777215 μ s. It represents the magnitude of the difference in period between the reference and feedback signals at the input to the DPLL. For example, if the reference signal is 1.25 MHz and the feedback signal is 1.38 MHz, the period difference is approximately 75.36 ns ($|1/1,250,000 - 1/1,380,000| \approx 75.36$ ns).

Frequency Clamp

The AD9558 DPLL features a digital tuning word clamp that ensures that the DPLL output frequency stays within a defined range. This feature is very useful to eliminate undesirable behavior in cases where the reference input clocks may be unpredictable. The tuning word clamp is also useful to guarantee that the APLL never loses lock by ensuring that the APLL VCO frequency stays within its tuning range.

Frequency Tuning Word History

The AD9558 has the ability to track the history of the tuning word samples generated by the DPLL digital loop filter output. It does so by periodically computing the average tuning word value over a user-specified interval. This average tuning word is used during holdover mode to maintain the average frequency when no input references are present.

LOOP CONTROL STATE MACHINE

Switchover

Switchover occurs when the loop controller switches directly from one input reference to another. The AD9558 handles a reference switchover by briefly entering holdover mode, loading the new DPLL parameters, and then immediately recovering. During the switchover event, however, the AD9558 preserves the status of the lock detectors to avoid phantom unlock indications.

Holdover

The holdover state of the DPLL is typically used when none of the input references are present, although the user can also manually engage holdover mode. In holdover mode, the output

frequency remains constant. The accuracy of the AD9558 in holdover mode is dependent on the device programming and availability of tuning word history.

Recovery from Holdover

When the AD9558 is in holdover mode and a valid reference becomes available, the device exits holdover operation. The loop state machine restores the DPLL to closed-loop operation, locks to the selected reference, and sequences the recovery of all the loop parameters based on the profile settings for the active reference.

Note that, if the user holdover bit is set, the device does not automatically exit holdover when a valid reference is available. However, automatic recovery can occur after clearing the user holdover bit (Bit 6 in Register 0x0A01).

SYSTEM CLOCK (SYSCLK)

SYSTEM CLOCK INPUTS

Functional Description

The SYSCLK circuit provides a low jitter, stable, high frequency clock for use by the rest of the chip. The XOA and XOB pins connect to the internal SYSCLK multiplier. The SYSCLK multiplier can synthesize the system clock by connecting a crystal resonator across the XOA and XOB input pins or by connecting a low frequency clock source. The optimal signal for the system clock input is either a crystal in the 50 MHz range or an ac-coupled square wave with a 1 V p-p amplitude.

System Clock Period

For the AD9558 to accurately measure the frequency of incoming reference signals, the user must enter the system clock period into the nominal system clock period registers (Register 0x0103 to Register 0x0105). The SYSCLK period is entered in units of nanoseconds (ns).

System Clock Details

There are two internal paths for the SYSCLK input signal: low frequency non-xtal (LF) and crystal resonator (XTAL).

Using a TCXO for the system clock is a common use for the LF path. Applications requiring DPLL loop bandwidths of less than 50 Hz or high stability in holdover require a TCXO. As an alternative to the 49.152 MHz crystal for these applications, the AD9558 reference design uses a 19.2 MHz TCXO, which offers excellent holdover stability and a good combination of low jitter and low spurious content.

The 1.8 V differential receiver connected to the XOA and XOB pins is self-biased to a dc level of approximately 1 V, and ac coupling is strongly recommended. When a 3.3 V CMOS oscillator is in use, it is important to use a voltage divider to reduce the input high voltage to a maximum of 1.8 V. See Figure 34 for details on connecting a 3.3 V CMOS TCXO to the system clock input.

The non-xtal input path permits the user to provide an LVPECL, LVDS, 1.8 V CMOS, or sinusoidal low frequency clock for multiplication by the integrated SYSCLK PLL. The LF path handles input frequencies from 3.5 MHz up to 100 MHz. However, when using a sinusoidal input signal, it is best to use a frequency that is in excess of 20 MHz. Otherwise, the resulting low slew rate can lead to substandard noise performance. Note that the non-XTAL path includes an optional 2× frequency multiplier to double the rate at the input to the SYSCLK PLL and potentially reduce the PLL in-band noise. However, to avoid exceeding the maximum PFD rate of 150 MHz, the 2× frequency multiplier is only for input frequencies that are below 75 MHz.

The non-XTAL path also includes an input divider (M) that is programmable for divide-by-1, -2, -4, or -8. The purpose of the divider is to limit the frequency at the input to the PLL to less than 150 MHz (the maximum PFD rate).

The XTAL path enables the connection of a crystal resonator (typically 10 MHz to 50 MHz) across the XOA and XOB input

pins. An internal amplifier provides the negative resistance required to induce oscillation. The internal amplifier expects an AT cut, fundamental mode crystal with a maximum motional resistance of 100 Ω. The following crystals, listed in alphabetical order, may meet these criteria. Analog Devices, Inc., does not guarantee their operation with the AD9558 nor does Analog Devices endorse one crystal supplier over another. The AD9558 reference design uses a 49.152 MHz crystal, which is high performance, low spurious content, and readily available.

- AVX/Kyocera CX3225SB
- ECS ECX-32
- Epson/Toyocom TSX-3225
- Fox FX3225BS
- NDK NX3225SA
- Siward SX-3225
- Suntu SCM10B48-49.152 MHz

The AD9558 reference design also has a place to mount a 5 mm × 7 mm TCXO. A TCXO with a CMOS output is strongly recommended instead of a clipped sine wave output. The following TCXOs, listed in alphabetical order, may meet this criteria. Analog Devices does not guarantee their does Analog Devices endorse one TCXO supplier over another.operation with the AD9558 nor

- AVX/Kyocera KT7050A
- Vectron TX-700
- Rakon RPT7050J

SYSTEM CLOCK MULTIPLIER

The SYSCLK PLL multiplier is an integer-N design with an integrated VCO. It provides a means to convert a low frequency clock input to the desired system clock frequency, f_{SYS} (750 MHz to 805 MHz). The SYSCLK PLL multiplier accepts input signals of between 3.5 MHz and 600 MHz; however, frequencies that are in excess of 150 MHz require the system clock P divider to ensure compliance with the maximum PFD rate (150 MHz). The PLL contains a feedback divider (N) that is programmable for divide values between 4 and 255.

$$f_{\text{SYS}} = f_{\text{OSC}} \times \frac{\text{sysclk_Ndiv}}{\text{sysclk_Pdiv}}$$

where:

f_{OSC} is the frequency at the XOA and XOB pins.

sysclk_Ndiv is the value stored in Register 0x0100.

sysclk_Pdiv is the system clock P divider that is determined by the setting of Register 0x0101, Bits[2:1].

If the system clock doubler is used, the value of sysclk_Ndiv must be half of its original value.

The system clock multiplier features a simple lock detector that compares the time difference between the reference and feedback edges. The most common cause of the SYSCLK multiplier not locking is a non-50% duty cycle at the SYSCLK input while the system clock doubler is enabled.

System Clock Stability Timer

Because the reference monitors depend on the system clock being at a known frequency, it is important that the system clock be stable before activating the monitors. At initial power-up, the system clock status is not known, and, therefore, it is reported as being unstable. After the device has been programmed, the system clock PLL (if enabled) eventually locks. When a

stable operating condition is detected, a timer is run for the duration that is stored in the system clock stability period registers. If at any time during this waiting period, the condition is violated, the timer is reset and halted until a stable condition is reestablished. After the specified period elapses, the [AD9558](#) reports the system clock as stable.

OUTPUT PLL (APLL)

A diagram of the output PLL (APLL) is shown in Figure 42.

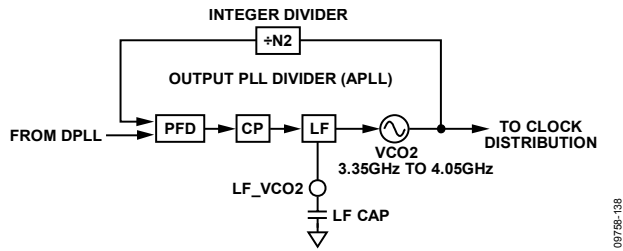

Figure 42. Output PLL Block Diagram

The APLL provides the frequency upconversion from the DPLL output to the 3.35 GHz to 4.05 GHz range, while also providing noise filtering on the DPLL output. The APLL reference input is the output of the DPLL. The feedback divider is an integer divider. The loop filter is partially integrated with the one external 6.8 nF capacitor. The nominal loop bandwidth for this PLL is 250 kHz, with 68° of phase margin.

The frequency wizard that is included in the evaluation software configures the APLL, and the user does not need to make changes to the APLL settings. However, there may be special cases where the user may want to adjust the APLL loop bandwidth to meet a specific phase noise requirement. The easiest way to change the APLL loop bandwidth is to adjust the APLL charge pump current in Register 0x0400. There is sufficient stability (68° of phase margin) in the APLL default settings to permit a broad range of adjustment without causing the APLL to be unstable. Contact Analog Devices directly if more detail is needed.

Calibration of the APLL must be performed at startup and when the nominal input frequency to the APLL changes by more than ± 100 ppm, although the APLL maintains lock over voltage and temperature extremes without recalibration. Calibration centers the dc operating voltage at the input to the APLL VCO.

APLL calibration at startup can be accomplished during initial register loading by following the instructions in the Device Register Programming Using a Register Setup File section of this data sheet.

To recalibrate the APLL VCO after the chip has been running, the user must first input the new settings (if any). Ensure that the system clock is still locked and stable, and that the DPLL is in free run mode with the free run tuning word set to the same output frequency that is used when the DPLL is locked.

Take the following steps to calibrate the APLL VCO:

1. Ensure that the system clock is locked and stable.
2. Ensure that the DPLL is in user free run mode (Register 0x0A01[5] = 1b), and that the free run tuning word is set.
3. Write Register 0x0405 = 0x20.
4. Write Register 0x0005 = 0x01.
5. Write Register 0x0405 = 0x21.
6. Write Register 0x0005 = 0x01.

Monitor the APLL status using Bit 2 in Register 0x0D01.

CLOCK DISTRIBUTION

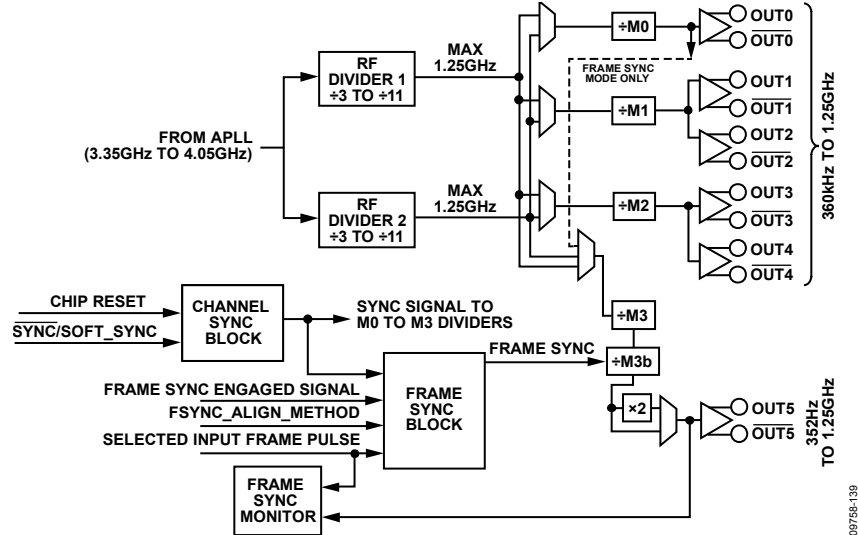

Figure 43. Clock Distribution Block Diagram

RF DIVIDERS (RF DIVIDER 2 AND RF DIVIDER 1)

The first block in each clock distribution section is the RF divider. The RF dividers divide the VCO output frequency down to a maximum frequency of ≤ 1.25 GHz and has special circuitry to maintain a 50% duty cycle for any divide ratio.

The following register addresses contain the RF divider settings:

- RF Divider 1: Register 0x0407, Bits[3:0]
- RF Divider 2: Register 0x0407, Bits[7:4]

In normal operation, the RF dividers do not need to be reset because the APLL VCO calibration (which normally occurs after programming the RF divider) automatically performs an RF divider reset.

However, in cases where the user wants to change either of the RF dividers, but not recalibrate the corresponding APLL VCO afterward, the user must first reset that RF divider by writing 0x0F to the appropriate RF divider register and then issuing an I/O update by writing Register 0x0005 = 0x01. At this point, the user can program the new RF divider value, and issue another I/O update.

CHANNEL DIVIDERS

The channel divider blocks, M0, M1, M2, M3, and M3b, are 10-bit integer dividers with a divide range of 1 to 1023. The channel divider block contains duty cycle correction that guarantees 50% duty cycle for both even and odd divide ratios.

OUTPUT POWER-DOWN

The output drivers can be individually powered down.

OUTPUT ENABLE

Each of the output channels offers independent control of enable/disable functionality via the distribution enable register. The distribution outputs use synchronization logic to control enable/disable activity to avoid the production of runt pulses and to ensure that outputs with the same divide ratios become active/inactive in unison.

OUTPUT MODE

The user has independent control of the operating mode of each of the four output channels via the output clock distribution registers (Address 0x0500 to Address 0x0515). The operating mode control includes

- Logic family and pin functionality
- Output drive strength
- Output polarity
- Divide ratio
- Phase of each output channel

Channel 0 and Channel 3 provide 3.3 V CMOS and 1.8 V CMOS modes. Channel 1 and Channel 2 have 1.8 V CMOS, LVDS, and HSTL modes.

All CMOS drivers feature a CMOS drive strength that allows the user to choose between a strong, high performance CMOS driver or a lower power setting with less EMI and crosstalk. The best setting is application dependent.

For applications where LVPECL levels are required, the user must choose the HSTL mode and ac couple the output signal. See the Input/Output Termination Recommendations section for recommended termination schemes.

CLOCK DISTRIBUTION SYNCHRONIZATION

Divider Synchronization

The dividers in the clock distribution channels can be synchronized with each other.

At power-up, the clock dividers are held static until a sync signal is initiated by the channel sync block. The following are possible sources of a sync signal, and these settings are found in Register 0x0500:

- Direct sync via Bit 2 of Register 0x0500
- Direct sync via a sync op code (0xA1) in the EEPROM storage sequence during EEPROM loading
- DPLL phase or frequency lock
- A rising edge of the selected reference input
- The SYNC pin
- A multifunction pin configured for the sync signal

The APLL lock detect signal gates the sync signal from the channel sync block shown in Figure 43. The channel dividers

receive a sync signal from the channel sync block only if the APLL is calibrated and locked, unless the APLL locked controlled sync disable bit (Register 0x0405, Bit 3) is set.

A channel can be programmed to ignore the sync function by setting the mask channel sync bits in Register 0x0500, Bits[7:4]. When programmed to ignore the sync, the channel ignores both the user initiated sync signal and the zero delay initiated sync signals, and the channel divider starts toggling, provided that the APLL is calibrated and locked, or if the APLL locked controlled sync disable bit (Register 0x0405, Bit 3) is set.

If the output sync function is to be controlled using an M pin, take the following steps:

1. Enable the M pins by writing Register 0x0200 = 0x01.
2. Issue an I/O update (Register 0x0005 = 0x01).
3. Set the appropriate M pin function.

If this process is not followed, a sync pulse is issued automatically.

FRAME SYNCHRONIZATION

The AD9558 provides frame synchronization function/mode. With this function, the AD9558 can take a pair of signals consisting of a reference clock and a 2 kHz or 8 kHz frame pulse as input signals and generate a pair of signals consisting of a synchronized output clock and an output frame pulse, while the output frame pulse is also synchronized with the input frame pulse. The reference clock is used to synthesize the output clock and output frame pulse through the DPLL, output PLL, or distribution and the input frame pulse is used to control the phase of the output frame pulse.

Frame synchronization is not supported in the soft or hard pin control mode.

REFERENCE CONFIGURATION IN FRAME SYNCHRONIZATION MODE

In frame synchronization mode, four AD9558 reference inputs (REFA, REFB, REFC, and REFD) are arranged into two pairs of signals: REFA and REFC form a pair of input clock/input frame pulses, with REFA as the input clock and REFC as the frame pulse. REFB and REFD form the second pair of input clock/input frame pulses with REFB as the input clock and REFD is the frame pulse. During reference switchover, only two input clocks, REFA and REFB, are assigned with a priority index. The two frame pulses, REFC and REFD, are not assigned with the priority index (the priority register bits in the profiles associated with input frame pulse are ignored). Each pair of input clock/ frame pulses participates in the reference selection as a group, and the valid state and priority of the pair are used in determining the reference selection. The priority of the pair is indicated by the priority index of the input clock in the pair.

Users have the option to either include or exclude the valid state of the input frame pulse in the reference selection by programming the validate FSYNC reference bit (Register 0x0641, Bit 3). When Register 0x0641, Bit 3 is programmed to 1b, the valid state of the input frame pulse and the valid state of the paired input clock are logically AND'ed, and the result is used to indicate the valid state of the pair. When the validate FSYNC reference bit is programmed to 0b, the valid state of the input frame pulse is excluded in reference selection and only the valid state of the input clock in the pair is used to indicate the valid state of the pair. The valid pair with the higher priority index is selected as the DPLL reference and input frame pulse to control the phase of the output frame pulse. If no pair is valid, the selection does not change, and the DPLL is switched to either holdover or free run mode, and the phase of the output frame pulse is not controlled by any of the input frame pulses. The five reference switchover modes for frame synchronization mode is the same as for normal mode.

CLOCK OUTPUTS IN FRAME SYNCHRONIZATION MODE

The AD9558 has six outputs (OUT0 to OUT5). In frame sync mode, OUT0 and OUT5 form the pair of output clock (OUT0) and output frame (OUT5) pulses. The frequency of OUT0 is required to have the integer relation with the frequency of the OUT5 ($f_{OUT0} = M \times f_{OUT5}$). The rest of the outputs (OUT1 to OUT4) do not participate in frame synchronization mode and are programmed and synchronized with each other, the same as in normal mode (except for the SYNC function). However, OUT1 to OUT4 must not be synchronized with the OUT0/OUT5.

CONTROL REGISTERS FOR FRAME SYNCHRONIZATION MODE

The frame synchronization function is enabled by setting Register 0x0640, Bit 0 to 1b. When Register 0x0640, Bit 0 = 1b, the following occurs:

- The frame synchronization control bits (Register 0x0641, Bits[3:0]) are enabled.
- The SYNC pin switches from the SYNC function to frame SYNC function. In frame synchronization mode, SYNC cannot be used as clock distribution synchronization function as it is in normal mode. Instead it is used as the frame synchronization arm function.

When the AD9558 is in frame synchronization mode, the frame synchronization function can be armed by either the SYNC pin or the arm soft FSYNC bit (Register 0x0641, Bit 0), which is selected by the FSYNC arm method bit (Register 0x0641, Bit 1). A value of 0b (which is the default) selects the SYNC pin as the arm method. If SYNC is selected as the arm method, SYNC = low arms OUT5; if the register is selected as the arm method, Register 0x0641, Bit 0 = 1b arms OUT5. Once armed, the output frame pulse on OUT5 is edge aligned with the paired output clock edge after the rising edge of the input frame pulse.

LEVEL SENSITIVE MODE AND ONE-SHOT MODE

The frame synchronization function can operate in level sensitive or one-shot mode as determined by the FSYNC one shot bit (Register 0x0641, Bit 2). When in level sensitive mode (Register 0x0641, Bit 2 = 0b) and the frame sync arm signal is high, each rising edge of the selected input frame pulse signal is used to control the phase of the output frame pulse. When in one-shot mode, after the frame sync arm signal is high, only the immediate next rising edge of the selected input frame pulse signal is used to control the phase of the output frame pulse (one time phase alignment). After that, the phase of the output frame pulse is not controlled by the selected input frame pulse. Instead, it follows the phase of the input clock of M3 divider. In either alignment control mode, the resolution of the phase realignment between the input frame pulse and the output frame pulse is one clock cycle of the paired clock output.

M3b DIVIDER/OUT5 PROGRAMMING IN FRAME SYNCHRONIZATION MODE

In frame synchronization mode, the clock distribution signal path for OUT5 is changed as follows: the OUT5 signal goes from the RF divider to the M0 divider, and then to the M3 and M3b dividers.

This means that in frame synchronization mode, the total divide ratio between the RF divider and OUT5 is $M0 \times M3 \times M3b$.

The other important change is that the sync signal for the M3b divider is no longer the standard clock distribution sync. It is controlled by a signal derived from the input frame pulse.

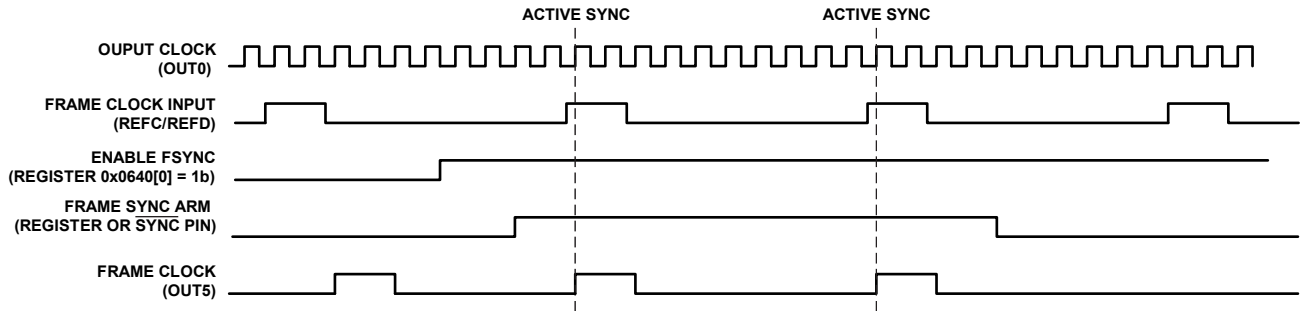

- NOTES
1. AFTER THE FRAME SYNC IS ARMED, THE FRAME CLOCK OUTPUT IS SYNCHRONIZED TO THE FRAME CLOCK INPUT. THE SKEW BETWEEN THE FRAME CLOCK INPUT AND FRAME CLOCK OUTPUT IS 15ns (NOMINAL) PLUS A DELAY OF 0.5 TO 1.5 OUTPUT CLOCK CYCLES.

Figure 44. Frame Synchronization in Level Sensitive Mode

09758-141

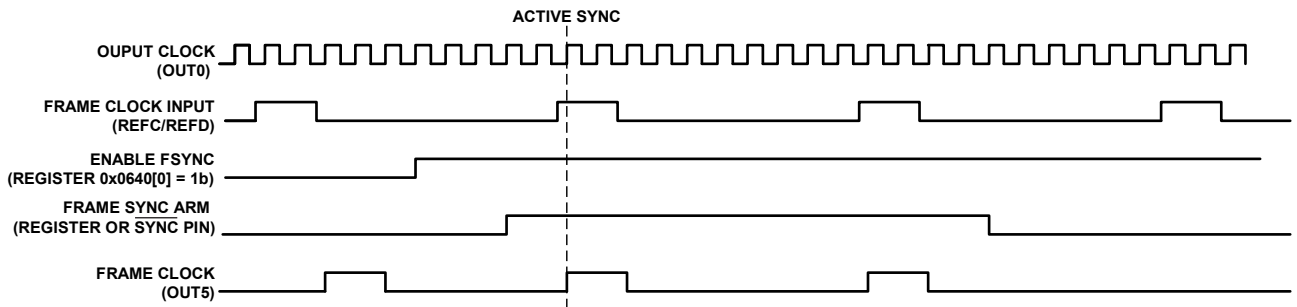

- NOTES
1. AFTER THE FRAME SYNC IS ARMED, THE FRAME CLOCK OUTPUT IS SYNCHRONIZED TO THE FRAME CLOCK INPUT. THE SKEW BETWEEN THE FRAME CLOCK INPUT AND FRAME CLOCK OUTPUT IS 15ns (NOMINAL) PLUS 0.5 TO 1.5 OUTPUT CLOCK CYCLES.

Figure 45. Frame Synchronization in One-Shot Mode

09758-142

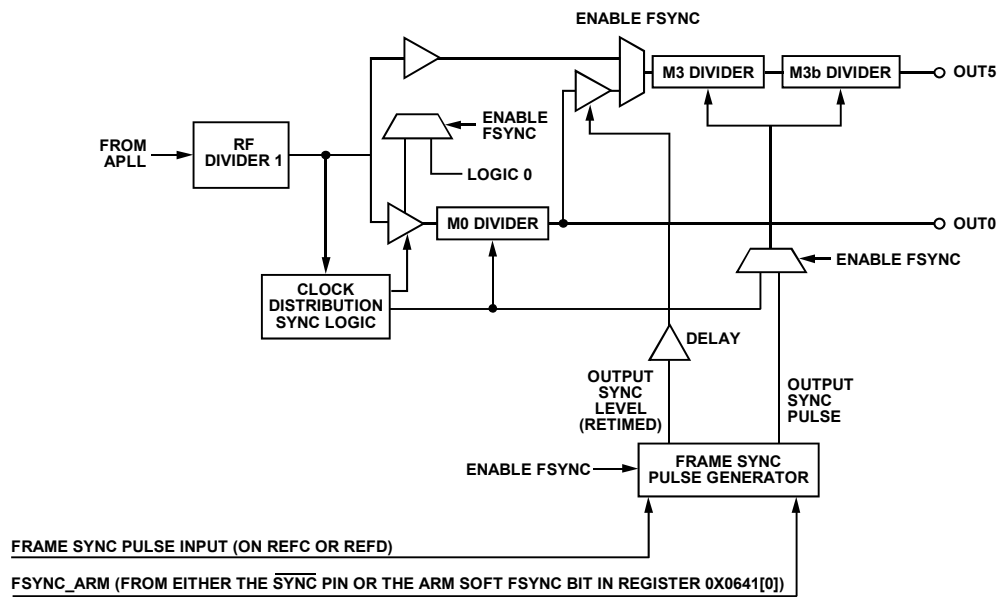

- NOTES
1. THE ENABLE FSYNC FUNCTION IN THE DIAGRAM IS CONTROLLED BY REGISTER 0X0640[0].

Figure 46. Frame Synchronization Implementation

09758-143

STATUS AND CONTROL

MULTIFUNCTION PINS (M7 TO M0)

The AD9558 has eight digital CMOS I/O pins (M7 to M0) that are configurable for a variety of uses. To use these functions, the user must enable them by writing a 0x01 to Register 0x0200. The function of these pins is programmable via the register map. Each pin can control or monitor an assortment of internal functions based on the contents of Register 0x0201 to Register 0x0208.

To monitor an internal function with a multifunction pin, write a Logic 1 to the most significant bit of the register associated with the desired multifunction pin. The value of the seven least significant bits of the register defines the control function, as shown in Table 129.

To control an internal function with a multifunction pin, write a Logic 0 to the most significant bit of the register associated with the desired multifunction pin. The monitored function depends on the value of the seven least significant bits of the register, as shown in Table 130.

If more than one multifunction pin operates on the same control signal, then internal priority logic ensures that only one multifunction pin serves as the signal source. The selected pin is the one with the lowest numeric suffix. For example, if both M0 and M3 operate on the same control signal, then M0 is used as the signal source and the redundant pins are ignored.

At power-up, the multifunction pins can be used to force the device into certain configurations as defined in the initial pin programming section. This functionality, however, is valid only during power-up or following a reset, after which the pins can be reconfigured via the serial programming port or via the EEPROM.

If the output SYNC function is to be controlled using an M pin,

1. Enable the M pins by writing Register 0x0200 = 0x01.
2. Issue an I/O update (Register 0x0005 = 0x01).
3. Set the appropriate M pin function.

If this process is not followed, a sync pulse is issued automatically.

IRQ Pin

The AD9558 has a dedicated interrupt request (IRQ) pin. Bits[1:0] of the IRQ pin output mode register (Register 0x0209) control how the IRQ pin asserts an interrupt based on the value of the two bits, as follows:

- 00: the IRQ pin is high impedance when deasserted and active low when asserted and requires an external pull-up resistor.
- 01: the IRQ pin is high impedance when deasserted and active high when asserted and requires an external pull-down resistor.
- 10: the IRQ pin is Logic 0 when deasserted and Logic 1 when asserted.
- 11: the IRQ pin is Logic 1 when deasserted and Logic 0 when asserted. (This is the default operating mode.)

The AD9558 asserts the IRQ pin when any bit in the IRQ monitor register (Address 0x0D02 to Address 0x0D07) is a Logic 1. Each bit in this register is associated with an internal function that is capable of producing an interrupt. Furthermore, each bit of the IRQ monitor register is the result of a logical AND of the associated internal interrupt signal and the corresponding bit in the IRQ mask register (Address 0x020A to Address 0x020E). That is, the bits in the IRQ mask register have a one-to-one correspondence with the bits in the IRQ monitor register. When an internal function produces an interrupt signal and the associated IRQ mask bit is set, the corresponding bit in the IRQ monitor register is set. The user must be aware that clearing a bit in the IRQ mask register removes only the mask associated with the internal interrupt signal. It does not clear the corresponding bit in the IRQ monitor register.

Note that the IRQ function detects a state change in the function that is being monitored. However, if IRQs are cleared (or if they are enabled for the first time), they do not generate for a pre-existing condition. The state must change after the IRQs are enabled. For example, if REFA is already invalid before the REFA invalid IRQ is enabled, the IRQ does not generate.

The IRQ pin is the result of a logical OR of all the IRQ monitor register bits. Thus, the AD9558 asserts the IRQ pin as long as any IRQ monitor register bit is a Logic 1. Note that it is possible to have multiple bits set in the IRQ monitor register. Therefore, when the AD9558 asserts the IRQ pin, it may indicate an interrupt from several different internal functions. The IRQ monitor register provides the user with a means to interrogate the AD9558 to determine which internal function produced the interrupt.

Typically, when the IRQ pin is asserted, the user interrogates the IRQ monitor register to identify the source of the interrupt request. After servicing an indicated interrupt, the user must clear the associated IRQ monitor register bit via the IRQ clearing register (Address 0x0A04 to Address 0x0A09). The bits in the IRQ clearing register have a one-to-one correspondence with the bits in the IRQ monitor register. Note that the IRQ clearing register is autoclearing. The IRQ pin remains asserted until the user clears all of the bits in the IRQ monitor register that indicate an interrupt.

It is also possible to collectively clear all of the IRQ monitor register bits by setting the clear all IRQs bit in the reset function register (Register 0x0A03, Bit 1). Note that this is an autoclearing bit. Setting this bit results in deassertion of the IRQ pin. Alternatively, the user can program any of the multifunction pins to clear all IRQs. This allows the user to clear all IRQs by means of a hardware pin rather than by using a serial I/O port operation.

WATCHDOG TIMER

The watchdog timer is a general purpose programmable timer. To set the timeout period, the user writes to the 16-bit watchdog timer register (Address 0x0210 to Address 0x0211). A value of 0b in this register disables the timer. A nonzero value sets the timeout period in milliseconds (ms), giving the watchdog timer a range of 1 ms to 65.535 sec. The relative accuracy of the timer is approximately 0.1% with an uncertainty of 0.5 ms.

If enabled, the timer runs continuously and generates a timeout event when the timeout period expires. The user has access to the watchdog timer status via the IRQ mechanism and the multifunction pins (M7 to M0). In the case of the multifunction pins, the timeout event of the watchdog timer is a pulse that lasts 32 system clock periods.

There are two ways to reset the watchdog timer (thereby preventing it from causing a timeout event). The first is by writing a Logic 1 to the autoclearing clear watchdog bit in the clear/reset functions register (Register 0x0A03, Bit 0). Alternatively, the user can program any of the multifunction pins to reset the watchdog timer. This allows the user to reset the timer by means of a hardware pin rather than by using a serial I/O port operation.

EEPROM

EEPROM Overview

The AD9558 contains an integrated, 2048-byte, electrically erasable, programmable read-only memory (EEPROM). The AD9558 can be configured to perform a download at power-up via the multifunction pins (M3 and M2), but uploads and downloads can also be done on demand via the EEPROM control registers (Address 0x0E00 to Address 0x0E03).

The EEPROM provides the ability to upload and download configuration settings to and from the register map. Figure 47 shows a functional diagram of the EEPROM.

Register 0x0E10 to Register 0x0E3F represent a 53-byte EEPROM storage sequence area (referred to as the scratch pad in this section) that enables the user to store a sequence of instructions for transferring data to the EEPROM from the device settings portion of the register map. Note that the default values for these registers provide a sample sequence for saving/retrieving all of the AD9558 EEPROM-accessible registers. Figure 47 shows the connectivity between the EEPROM and the controller that manages data transfer between the EEPROM and the register map.

The controller oversees the process of transferring EEPROM data to and from the register map. There are two modes of operation handled by the controller: saving data to the EEPROM (upload mode) or retrieving data from the EEPROM (download mode). In either case, the controller relies on a specific instruction set.

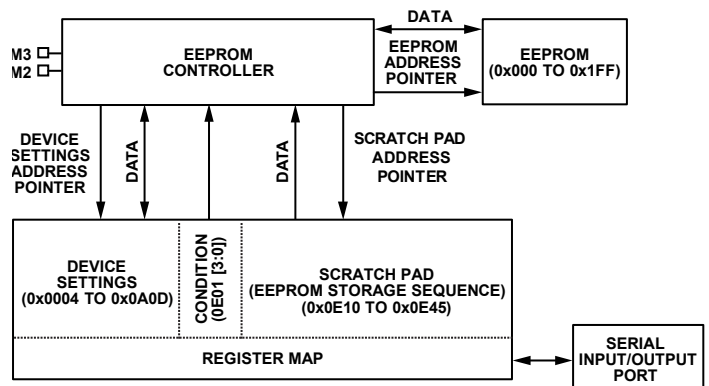

Figure 47. EEPROM Functional Diagram

Table 21. EEPROM Controller Instruction Set

Instruction Value (Hex)	Instruction Type	Bytes Required	Description
0x00 to 0x7F	Data	3	A data instruction tells the controller to transfer data to or from the device settings section of the register map. A data instruction requires two additional bytes that together, indicate a starting address in the register map. Encoded in the data instruction is the number of bytes to transfer, which is one more than the instruction value.
0x80	I/O update	1	When the controller encounters this instruction while downloading from the EEPROM, it issues a soft I/O update.
0xA0	Calibrate	1	When the controller encounters this instruction while downloading from the EEPROM, it initiates a system clock calibration sequence.
0xA1	Distribution sync	1	When the controller encounters this instruction while downloading from the EEPROM, it issues a sync pulse to the output distribution synchronization.
0xB0 to 0xCF	Condition	1	B1 to CF are condition instructions and correspond to Condition 1 through Condition 31, respectively. B0 is the null condition instruction. See the EEPROM Conditional Processing section for details.
0xFE	Pause	1	When the controller encounters this instruction in the EEPROM storage sequence area while uploading to the EEPROM, it holds both the scratch pad address pointer and the EEPROM address pointer at its last value. This allows storage of more than one instruction sequence in the EEPROM. Note that the controller does not copy this instruction to the EEPROM during upload.
0xFF	End	1	When the controller encounters this instruction in the the EEPROM storage sequence area while uploading to the EEPROM, it resets both the register area address pointer and the EEPROM address pointer and then enters an idle state. When the controller encounters this instruction while downloading from the EEPROM, it resets the EEPROM address pointer and then enters an idle state.

EEPROM Instructions

Table 21 lists the EEPROM controller instruction set. The controller recognizes all instruction types whether it is in upload or download mode, except for the pause instruction, which is recognized only in upload mode.

The I/O update, calibrate, distribution sync, and end instructions are mostly self-explanatory. The others, however, warrant further detail, as described in the following paragraphs.

Data instructions are those that have a value from 0x000 to 0x7FF. A data instruction tells the controller to transfer data between the EEPROM and the register map. The controller requires the following two parameters to carry out the data transfer:

- The number of bytes to transfer
- The register map target address

The controller decodes the number of bytes to transfer directly from the data instruction itself by adding one to the value of the instruction. For example, the 1A data instruction has a decimal value of 26; therefore, the controller knows to transfer 27 bytes (one more than the value of the instruction). When the controller encounters a data instruction, it knows to read the next two bytes in the scratch pad because these contain the register map target address.

Note that, in the EEPROM scratch pad, the two registers that comprise the address portion of a data instruction have the MSB of the address in the D7 position of the lower register address. The bit weight increases from left to right, from the lower register address to the higher register address. Furthermore, the starting address always indicates the lowest numbered register map address in the range of bytes to transfer. That is, the controller always starts at the register map target address and counts upward regardless of whether the serial I/O port is operating in I²C, SPI LSB-first, or SPI MSB-first mode.

As part of the data transfer process during an EEPROM upload, the controller calculates a 1-byte checksum and stores it as the final byte of the data transfer. As part of the data transfer process during an EEPROM download, however, the controller again calculates a 1-byte checksum value but compares the newly calculated checksum with the one that was stored during the upload process. If an upload/download checksum pair does not match, the controller sets the EEPROM fault status bit. If the upload/download checksums match for all data instructions encountered during a download sequence, the controller sets the EEPROM complete status bit.

Condition instructions are those that have a value from B0 to CF. The B1 to CF condition instructions represent Condition 1 to Condition 31, respectively. The B0 condition instruction is special because it represents the null condition (see the EEPROM Conditional Processing section).

A pause instruction, like an end instruction, is stored at the end of a sequence of instructions in the scratch pad. When the controller encounters a pause instruction during an upload sequence, it keeps the EEPROM address pointer at its last value. This way the user can store a new instruction sequence in the scratch pad and upload the new sequence to the EEPROM. The new sequence is stored in the EEPROM address locations immediately following the previously saved sequence. This process is repeatable until an upload sequence contains an end instruction. The pause instruction is also useful when used in conjunction with condition processing. It allows the EEPROM to contain multiple occurrences of the same registers, with each occurrence linked to a set of conditions (see the EEPROM Conditional Processing section).

EEPROM Upload

To upload data to the EEPROM, the user must first ensure that the write enable bit (Register 0x0E00, Bit 0) is set. Then, on setting the autoclearing save to EEPROM bit (Register 0x0E02, Bit 0), the controller initiates the EEPROM data storage process.

Uploading EEPROM data requires that the user first write an instruction sequence into the scratch pad registers. During the upload process, the controller reads the scratch pad data byte by byte, starting at Register 0x0E10 and incrementing the scratch pad address pointer as it goes, until it reaches a pause or end instruction.

As the controller reads the scratch pad data, it transfers the data from the scratch pad to the EEPROM (byte by byte) and increments the EEPROM address pointer accordingly, unless it encounters a data instruction. A data instruction tells the controller to transfer data from the device settings portion of the register map to the EEPROM. The number of bytes to transfer is encoded within the data instruction, and the starting address for the transfer appears in the next two bytes in the scratch pad.

When the controller encounters a data instruction, it stores the instruction in the EEPROM, increments the EEPROM address pointer, decodes the number of bytes to be transferred, and increments the scratch pad address pointer. Then it retrieves the next two bytes from the scratch pad (the target address) and increments the scratch pad address pointer by 2. Next, the controller transfers the specified number of bytes from the register map (beginning at the target address) to the EEPROM.

When it completes the data transfer, the controller stores an extra byte in the EEPROM to serve as a checksum for the transferred block of data. To account for the checksum byte, the controller increments the EEPROM address pointer by one more than the number of bytes transferred. Note that, when the controller transfers data associated with an active register, it actually transfers the buffered contents of the register (see the Buffered/Active Registers section for details on the difference between buffered and active registers). This allows the transfer of nonzero autoclearing register contents.

Note that conditional processing (see the EEPROM Conditional Processing section) does not occur during an upload sequence.

Manual EEPROM Download

A manual EEPROM download transfers register values from the EEPROM to the device register map. To download data, the user sets the autoclearing load from EEPROM bit (Register 0x0E03, Bit 1). This commands the controller to initiate the EEPROM download process. During download, the controller reads the EEPROM data byte by byte, incrementing the EEPROM address pointer as it goes, until it reaches an end instruction. As the controller reads the EEPROM data, it executes the stored instructions, which includes transferring stored data to the device settings portion of the register map when it encounters a data instruction.

To ensure robust operation, the EEPROM download must be allowed to complete (Register 0x0D00, Bit 1 returning to 0b) before other register writes are performed. If the EEPROM download is interrupted, the user may need to reset the AD9558 prior to attempting another EEPROM download.

Note that conditional processing (see the EEPROM Conditional Processing section) is applicable only when downloading.

Automatic EEPROM Download

Following a power-up, an assertion of the RESET pin, or a soft reset (Register 0x0000, Bit 5 = 1), if the PINCONTROL pin is low, and M3 and M2 are either high or low (see Table 22), the instruction sequence stored in the EEPROM executes automatically with one of eight conditions. If M3 and M2 are left floating and the PINCONTROL pin is low, the EEPROM is bypassed and the factory defaults are used. In this way, a previously stored set of register values downloads automatically on power-up or with a hard or soft reset. See the EEPROM Conditional Processing section for details regarding conditional processing and the way it modifies the download process.

To ensure robust operation, the automatic EEPROM download must be initiated by the power-on reset (POR) pulse, and not by the RESET pin. Holding the RESET pin low during power-up is not recommended because the reset caused by the rising edge of the RESET pin may interrupt the EEPROM download initiated by the POR pulse.

Table 22. EEPROM Setup

M3	M2	ID	EEPROM Download?
Low	Low	1	Yes, EEPROM Condition 1
Low	Open	2	Yes, EEPROM Condition 2
Low	High	3	Yes, EEPROM Condition 3
Open	Low	4	Yes, EEPROM Condition 4
Open	Open	0	No
Open	High	5	Yes, EEPROM Condition 5
High	Low	6	Yes, EEPROM Condition 6
High	Open	7	Yes, EEPROM Condition 7
High	High	8	Yes, EEPROM Condition 8

EEPROM Conditional Processing

The condition instructions allow conditional execution of EEPROM instructions during a download sequence. During an upload sequence, however, they are stored as is and have no effect on the upload process.

Note that, during EEPROM downloads, the condition instructions themselves and the end instruction always execute unconditionally.

Conditional processing makes use of two elements: the condition (from Condition 1 to Condition 8) and the condition tag board. The relationships among the condition, the condition tag board, and the EEPROM controller appear schematically in Figure 48.

The condition is a 4-bit value with 16 possibilities. Condition = 0 is the null condition. When the null condition is in effect, the EEPROM controller executes all instructions unconditionally. Condition 9 through Condition 15 are not accessible using the M pins. The remaining eight possibilities (that is, Condition = 1 through Condition = 8) modify the way the EEPROM controller handles a download sequence. The condition originates from one of two sources (see Figure 48), as follows:

- FNC_INIT, Bits[3:0], which is the state of the M2 and M3 multifunction pins at power-up (see Table 22)
- Register 0x0E01, Bits[3:0]

If Register 0x0E01, Bits[3:0] ≠ 0, then the condition is the value that is stored in Register 0x0E01, Bits[3:0]; otherwise, the condition is FNC_INIT, Bits[3:0]. Note that a nonzero condition that is present in Register 0x0E01, Bits[3:0] takes precedence over FNC_INIT, Bits[3:0].

The condition tag board is a table maintained by the EEPROM controller. When the controller encounters a condition instruction, it decodes the B1 through CF instructions as Condition = 1 through Condition = 8, respectively, and tags that particular condition in the condition tag board. However, the B0 condition instruction decodes as the null condition, for which the controller clears the condition tag board, and subsequent download instructions execute unconditionally (until the controller encounters a new condition instruction).

During download, the EEPROM controller executes or skips instructions depending on the value of the condition and the contents of the condition tag board. Note, however, that the condition instructions and the end instruction always execute unconditionally during download. If Condition = 0, all instructions during download execute unconditionally. If Condition ≠ 0 and there are any tagged conditions in the condition tag board, the controller executes instructions only if the condition is tagged. If the condition is not tagged, the controller skips instructions until it encounters a condition instruction that decodes as a tagged condition. Note that the condition tag board allows multiple conditions to be tagged at any given moment. This conditional processing mechanism enables the user to have one download instruction sequence with many possible outcomes depending on the value of the condition and the order in which the controller encounters condition instructions.

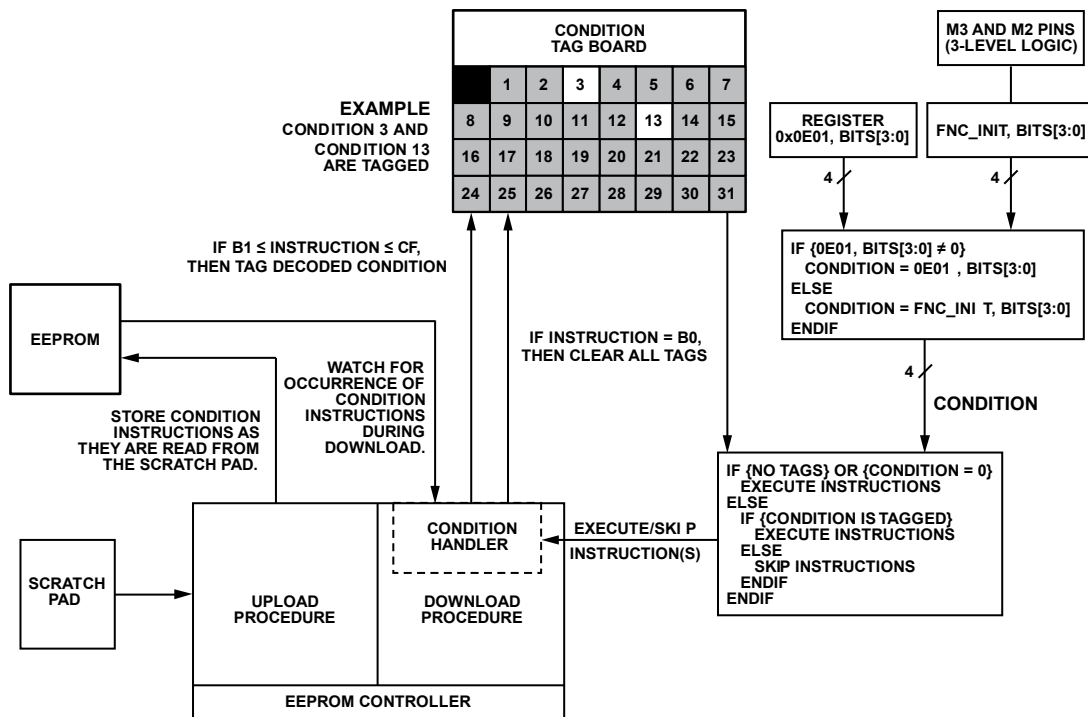

Figure 48. EEPROM Conditional Processing

Table 23 lists a sample EEPROM download instruction sequence. It illustrates the use of condition instructions and how they alter the download sequence. The table begins with the assumption that no conditions are in effect. That is, the most recently executed condition instruction is either B0 or no conditional instructions have been processed.

Table 23. EEPROM Conditional Processing Example

Instruction	Action
0x08 0x01 0x00	Transfer the system clock register contents, regardless of the current condition.
0xB1	Tag Condition 1.
0x19 0x04 0x00	Transfer the clock distribution register contents only if tag condition = 1.
0xB2	Tag Condition 2.
0xB3	Tag Condition 3.
0x07 0x05 0x00	Transfer the reference input register contents only if tag condition = 1, 2, or 3.
0x0A	Calibrate the system clock only if tag condition = 1, 2, or 3.
0xB0	Clear the tag condition board.
0x80	Execute an I/O update, regardless of the value of the tag condition.
0x0A	Calibrate the system clock, regardless of the value of the tag condition.

Storing Multiple Device Setups in EEPROM

Conditional processing makes it possible to create a number of different device setups, store them in EEPROM, and download a specific setup on demand. To do so, first program the device control registers for a specific setup. Then, store an upload sequence in the EEPROM scratch pad with the following general form:

1. Condition instruction (B1 to CF) to identify the setup with a specific condition (1 to 31)
2. Data instructions (to save the register contents) along with any required calibrate and/or I/O update instructions
3. Pause instruction (FE)

With the upload sequence written to the scratch pad, perform an EEPROM upload (Register 0x0E02, Bit 0).

Reprogram the device control registers for the next desired setup. Then, store a new upload sequence in the EEPROM scratch pad with the following general form:

1. Condition instruction (B0)
2. The next desired condition instruction (B1 to CF, but different from the one used during the previous upload to identify a new setup)
3. Data instructions (to save the register contents) along with any required calibrate and/or I/O update instructions
4. Pause instruction (FE)

With the upload sequence written to the scratch pad, perform an EEPROM upload (Register 0x0E02, Bit 0).

Repeat the process of programming the device control registers for a new setup, storing a new upload sequence in the EEPROM scratch pad (Step 1 through Step 4), and executing an EEPROM upload (Register 0x0E02, Bit 0) until all of the desired setups have been uploaded to the EEPROM.

Note that, on the final upload sequence stored in the scratch pad, the pause instruction (FE) must be replaced with an end instruction (FF).

To download a specific setup on demand, first store the condition associated with the desired setup in Register 0x0E01, Bits[3:0]. Then perform an EEPROM download (Register 0x0E03, Bit 1). Alternatively, to download a specific setup at power-up, apply the required logic levels necessary to encode the desired condition on the M2 and M3 multifunction pins. Then, power up the device; an automatic EEPROM download occurs. The condition (as established by the M2 and M3 multifunction pins) guides the download sequence and results in a specific setup.

Keep in mind that the number of setups that can be stored in the EEPROM is limited. The EEPROM can hold a total of 2048 bytes. Each nondata instruction requires one byte of storage. Each data instruction, however, requires $N + 4$ bytes of storage, where N is the number of transferred register bytes and the other four bytes include the data instruction itself (one byte), the target address (two bytes), and the checksum calculated by the EEPROM controller during the upload sequence (one byte).

Programming the EEPROM to Configure an M Pin to Control Synchronization of Clock Distribution

A special EEPROM loading sequence is required to use the EEPROM to load the registers and to use an M pin to enable/disable outputs.

To control the output sync function by using an M pin, perform the following steps:

1. Enable the M pins by writing Register 0x0200 = 0x01.
2. Issue an I/O update (Register 0x0005 = 0x01).
3. Set the appropriate M pin function (see the Clock Distribution Synchronization section for details).

If this sequence is not performed, a sync pulse is issued automatically.

The following changes write Register 0x0200 first and then issue an I/O update before writing the remaining M pin configuration registers in Register 0x0201 to Register 0x0208.

The default EEPROM loading sequence from Register 0x0E10 to Register 0x0E16 is unchanged. The following steps must be inserted into the EEPROM storage sequence:

1. Register 0x0E17 = 0x00. Write one byte at Register 0x0200.
2. Register 0x0E18 = 0x02.
3. Register 0x0E19 = 0x00.
4. Register 0x0E1A = 0x80. EEPROM command for an I/O update.
5. Register 0x0E1B = 0x10. Transfer 17 bytes to EEPROM.
6. Register 0x0E1C = 0x02. Transfer starts at Address 0x0201.
7. Register 0x0E1D = 0x01.

The rest of the EEPROM loading sequence is the same as the default EEPROM loading sequence, except that the register address of the EEPROM storage sequence is shifted down four bytes from the default. For example,

- Register 0x0E1E = default value of Register 0x0E1A = 0x2E
- Register 0x0E1F = default value of Register 0x0E1B = 0x03
- Register 0x0E20 = default value of Register 0x0E1C = 0x00
- ...
- Register 0x0E40 = default value of Register 0x0E1C = 0x3C = 0xFF

SERIAL CONTROL PORT

The AD9558 serial control port is a flexible, synchronous serial communications port that provides a convenient interface to many industry-standard microcontrollers and microprocessors. The AD9558 serial control port is compatible with most synchronous transfer formats, including I²C, Motorola SPI, and Intel SSR protocols. The serial control port allows read/write access to the AD9558 register map.

In SPI mode, single or multiple byte transfers are supported. The SPI port configuration is programmable via Register 0x0000. This register is integrated into the SPI control logic rather than in the register map and is distinct from the I²C Register 0x0000. It is also inaccessible to the EEPROM controller.

Although the AD9558 supports both the SPI and I²C serial port protocols, only one or the other is active following power-up (as determined by the M0 and M1 multifunction pins during the start-up sequence). That is, the only way to change the serial port protocol is to reset the device (or cycle the device power supply).

SPI/I²C PORT SELECTION

Because the AD9558 supports both SPI and I²C protocols, the active serial port protocol depends on the logic state of the PINCONTROL, M1, and M0 pins. The PINCONTROL pin must be low, and the state of the M0 and M1 pins determines the I²C address, or if SPI mode is enabled. See Table 24 for the I²C address assignments.

Table 24. SPI/I²C Serial Port Setup

M1	M0	SPI/I ² C
Low	Low	SPI
Low	Open	I ² C, 1101000
Low	High	I ² C, 1101001
Open	Low	I ² C, 1101010
Open	Open	I ² C, 1101011
Open	High	I ² C, 1101100
High	Low	I ² C, 1101101
High	Open	I ² C, 1101110
High	High	I ² C, 1101111

SPI SERIAL PORT OPERATION

Pin Descriptions

The serial clock pin (SCLK) serves as the serial shift clock. This pin is an input. SCLK synchronizes serial control port read and write operations. The rising edge of SCLK registers write data bits, and the falling edge registers read data bits. The SCLK pin supports a maximum clock rate of 40 MHz.

The serial data input/output pin (SDIO) is a dual-purpose pin and acts as either an input only (unidirectional mode) or as both an input and an output (bidirectional mode). The AD9558 default SPI mode is bidirectional.

The SDO (serial data output) pin is useful only in unidirectional I/O mode. It serves as the data output pin for read operations.

The chip select pin ($\overline{\text{CS}}$) is an active low control that gates read and write operations. This pin is internally connected to a 30 k Ω pull-up resistor. When $\overline{\text{CS}}$ is high, the SDO and SDIO pins go into a high impedance state.

SPI Mode Operation

The SPI port supports both 3-wire (bidirectional) and 4-wire (unidirectional) hardware configurations and both MSB-first and LSB-first data formats. Both the hardware configuration and data format features are programmable. By default, the AD9558 uses the bidirectional MSB-first mode. The reason that bidirectional is the default mode is so that the user can still write to the device, if it is wired for unidirectional operation, to switch to unidirectional mode.

Assertion (active low) of the $\overline{\text{CS}}$ pin initiates a write or read operation to the AD9558 SPI port. For data transfers of three bytes or fewer (excluding the instruction word), the device supports the $\overline{\text{CS}}$ stalled high mode (see Table 25). In this mode, the $\overline{\text{CS}}$ pin can be temporarily deasserted on any byte boundary, allowing time for the system controller to process the next byte. $\overline{\text{CS}}$ can be deasserted only on byte boundaries, however. This applies to both the instruction and data portions of the transfer.

During stall high periods, the serial control port state machine enters a wait state until all data is sent. If the system controller decides to abort a transfer midstream, then the state machine must be reset either by completing the transfer or by asserting the $\overline{\text{CS}}$ pin for at least one complete SCLK cycle (but less than eight SCLK cycles). Deasserting the $\overline{\text{CS}}$ pin on a nonbyte boundary terminates the serial transfer and flushes the buffer.

In streaming mode (see Table 25), any number of data bytes can be transferred in a continuous stream. The register address is automatically incremented or decremented. $\overline{\text{CS}}$ must be deasserted at the end of the last byte that is transferred, thereby ending the streaming mode.

Table 25. Byte Transfer Count

W1	W0	Bytes to Transfer
0	0	1
0	1	2
1	0	3
1	1	Streaming mode

Communication Cycle—Instruction Plus Data

The SPI protocol consists of a two-part communication cycle. The first part is a 16-bit instruction word that is coincident with the first 16 SCLK rising edges and a payload. The instruction word provides the AD9558 serial control port with information regarding the payload. The instruction word includes the R/ $\overline{\text{W}}$ bit that indicates the direction of the payload transfer (that is, a read or write operation). The instruction word also indicates the number of bytes in the payload and the starting register address of the first payload byte.

Write

If the instruction word indicates a write operation, the payload is written into the serial control port buffer of the AD9558. Data bits are registered on the rising edge of SCLK. The length of the transfer (1, 2, or 3 bytes or streaming mode) depends on the W0 and W1 bits (see Table 25) in the instruction byte. When not streaming, \overline{CS} can be deasserted after each sequence of eight bits to stall the bus (except after the last byte, where it ends the cycle). When the bus is stalled, the serial transfer resumes when \overline{CS} is asserted. Deasserting the \overline{CS} pin on a nonbyte boundary resets the serial control port. Reserved or blank registers are not skipped over automatically during a write sequence. Therefore, the user must know what bit pattern to write to the reserved registers to preserve proper operation of the device. Generally, it does not matter what data is written to blank registers, but it is customary to write 0s.

Most of the serial port registers are buffered (see the Buffered/Active Registers section for details on the difference between buffered and active registers). Therefore, data written into buffered registers does not take effect immediately. An additional operation is required to transfer buffered serial control port contents to the registers that actually control the device. This is accomplished with an I/O update operation, which is performed in one of two ways. One is by writing a Logic 1 to Register 0x0005, Bit 0 (this bit is autoclearing). The other is to use an external signal via an appropriately programmed multifunction pin. The user can change as many register bits as desired before executing an I/O update. The I/O update operation transfers the buffer register contents to their active register counterparts.

Read

The AD9558 supports the long instruction mode only. If the instruction word indicates a read operation, the next $N \times 8$ SCLK cycles clock out the data from the address specified in the instruction word. N is the number of data bytes read and depends on the W0 and W1 bits of the instruction word. The readback data is valid on the falling edge of SCLK. Blank registers are not skipped over during readback.

A readback operation takes data from either the serial control port buffer registers or the active registers, as determined by Register 0x0004, Bit 0.

Table 27. Serial Control Port, 16-Bit Instruction Word, MSB First MSB

I15	I14	I13	I12	I11	I10	I9	I8	I7	I6	I5	I4	I3	I2	I1	I0	LSB
$\overline{R/W}$	W1	W0	A12	A11	A10	A9	A8	A7	A6	A5	A4	A3	A2	A1	A0	

SPI Instruction Word (16 Bits)

The MSB of the 16-bit instruction word is $\overline{R/W}$, which indicates whether the instruction is a read or a write. The next two bits, W1 and W0, indicate the number of bytes in the transfer (see Table 25).

The final 13 bits are the register address (A12 to A0), which indicates the starting register address of the read/write operation (see Table 27).

SPI MSB-/LSB-First Transfers

The AD9558 instruction word and payload can be MSB first or LSB first. The default for the AD9558 is MSB first. The LSB-first mode can be set by writing a 1 to Register 0x0000, Bit 6. Immediately after the LSB-first bit is set, subsequent serial control port operations are LSB first.

When MSB-first mode is active, the instruction and data bytes must be written from MSB to LSB. Multibyte data transfers in MSB-first format start with an instruction byte that includes the register address of the most significant payload byte. Subsequent data bytes must follow in order from high address to low address. In MSB-first mode, the serial control port internal address generator decrements for each data byte of the multibyte transfer cycle.

When Register 0x0000, Bit 6 = 1 (LSB first), the instruction and data bytes must be written from LSB to MSB. Multibyte data transfers in LSB-first format start with an instruction byte that includes the register address of the least significant payload byte followed by multiple data bytes. The serial control port internal byte address generator increments for each byte of the multibyte transfer cycle.

For multibyte MSB-first (default) I/O operations, the serial control port register address decrements from the specified starting address toward Address 0x0000. For multibyte LSB-first I/O operations, the serial control port register address increments from the starting address toward Address 0x1FFF. Reserved addresses are not skipped during multibyte I/O operations; therefore, the user must write the default value to a reserved register and 0s to unmapped registers. Note that it is more efficient to issue a new write command than to write the default value to more than two consecutive reserved (or unmapped) registers.

Table 26. Streaming Mode (No Addresses Are Skipped)

Write Mode	Address Direction	Stop Sequence
LSB First	Increment	0x0000 ... 0x1FFF
MSB First	Decrement	0x1FFF ... 0x0000

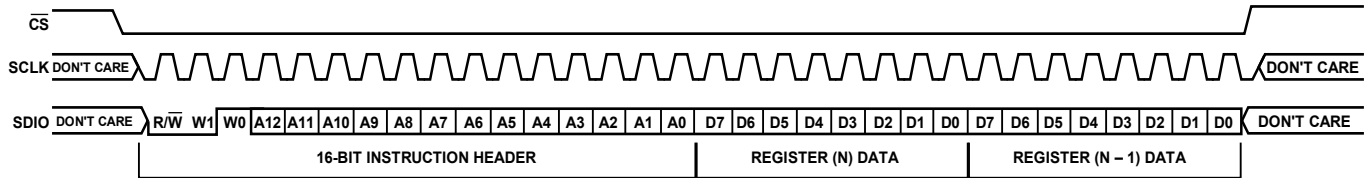

Figure 49. Serial Control Port Write—MSB First, 16-Bit Instruction, Two Bytes of Data

09758-029

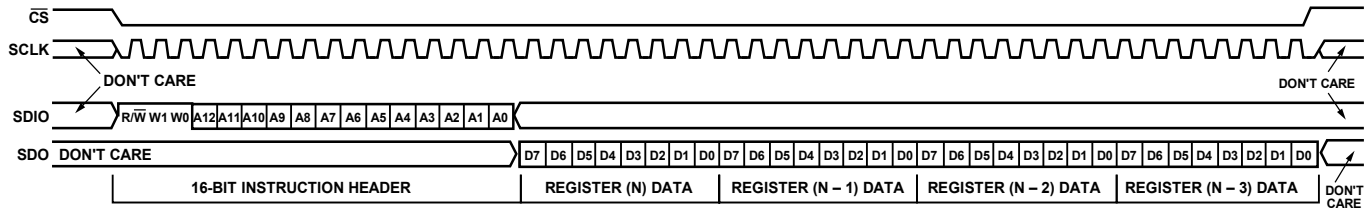

Figure 50. Serial Control Port Read—MSB First, 16-Bit Instruction, Four Bytes of Data

09758-030

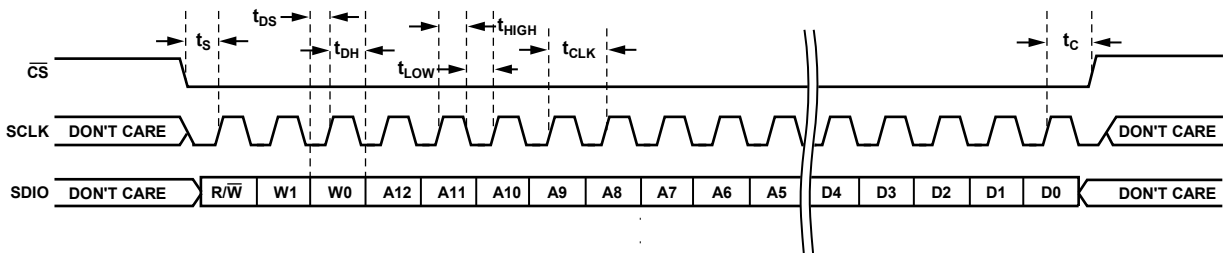

Figure 51. Serial Control Port Write—MSB First, 16-Bit Instruction, Timing Measurements

09758-031

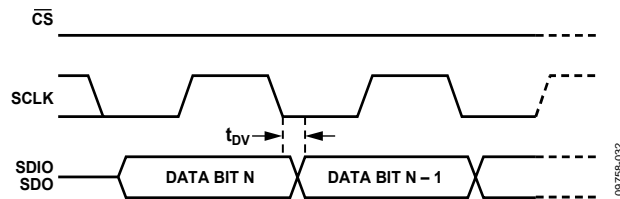

Figure 52. Timing Diagram for Serial Control Port Register Read

09758-032

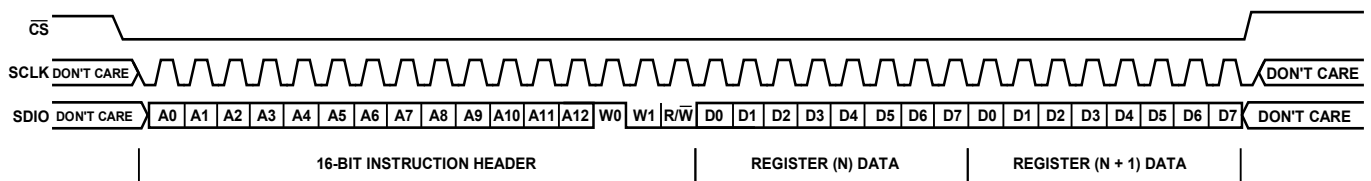

Figure 53. Serial Control Port Write—LSB First, 16-Bit Instruction, Two Bytes of Data

09758-033

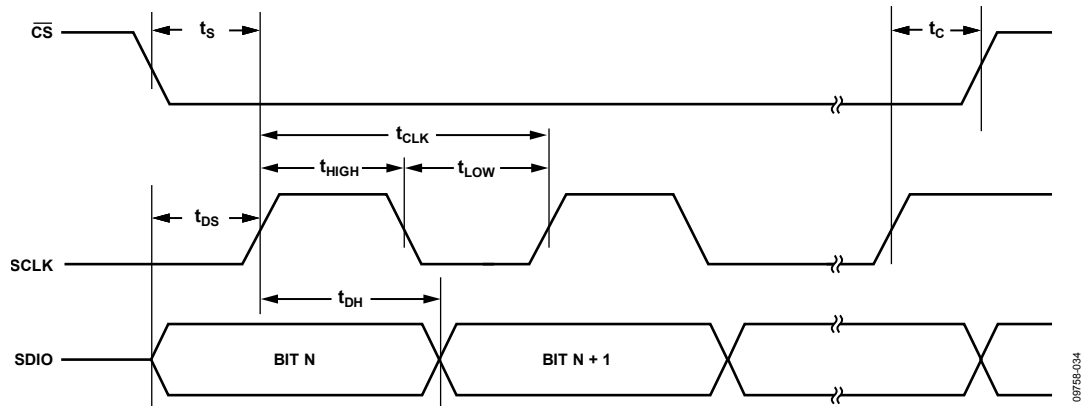

Figure 54. Serial Control Port Timing—Write

Table 28. Serial Control Port Timing

Parameter	Description
t_{DS}	Setup time between data and the rising edge of SCLK
t_{DH}	Hold time between data and the rising edge of SCLK
t_{CLK}	Period of the clock
t_s	Setup time between the \overline{CS} falling edge and the SCLK rising edge (start of the communication cycle)
t_c	Setup time between the SCLK rising edge and \overline{CS} rising edge (end of the communication cycle)
t_{HIGH}	Minimum period that SCLK needs to be in a logic high state
t_{LOW}	Minimum period that SCLK needs to be in a logic low state
t_{DV}	SCLK to valid SDIO and SDO (see Figure 52)

I²C SERIAL PORT OPERATION

The I²C interface has the advantage of requiring only two control pins and is a de facto standard throughout the I²C industry. However, its disadvantage is programming speed, which is 400 kbps maximum. The AD9558 I²C port design is based on the I²C fast mode standard; therefore, it supports both the 100 kHz standard mode and 400 kHz fast mode. Fast mode imposes a glitch tolerance requirement on the control signals. That is, the input receivers ignore pulses of less than 50 ns duration.

The AD9558 I²C port consists of a serial data line (SDA) and a serial clock line (SCL). In an I²C bus system, the AD9558 is connected to the serial bus (data bus SDA and clock bus SCL) as a slave device; that is, no clock is generated by the AD9558. The AD9558 uses direct 16-bit memory addressing instead of traditional 8-bit memory addressing.

The AD9558 allows up to seven unique slave devices to occupy the I²C bus. These are accessed via a 7-bit slave address that is transmitted as part of an I²C packet. Only the device that has a matching slave address responds to subsequent I²C commands. Table 24 lists the supported device slave addresses.

I²C Bus Characteristics

A summary of the various I²C protocols appears in Table 29.

Table 29. I²C Bus Abbreviation Definitions

Abbreviation	Definition
S	Start
Sr	Repeated start
P	Stop
A	Acknowledge
\bar{A}	Nonacknowledge
\bar{W}	Write
R	Read

The transfer of data is shown in Figure 55. One clock pulse is generated for each data bit transferred. The data on the SDA line must be stable during the high period of the clock. The high or low state of the data line can change only when the clock signal on the SCL line is low.

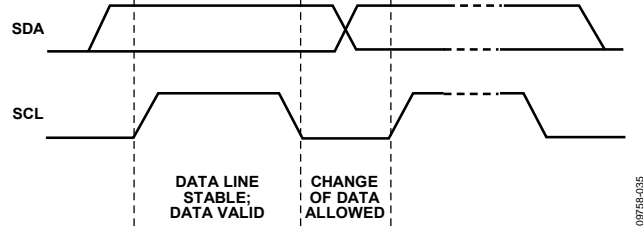

Figure 55. Valid Bit Transfer

Start/stop functionality is shown in Figure 56. The start condition is characterized by a high-to-low transition on the SDA line while SCL is high. The start condition is always generated by the master to initialize a data transfer. The stop condition is characterized by a low-to-high transition on the SDA line while SCL is high. The stop condition is always generated by the master to terminate a data transfer. Every byte on the SDA line must be eight bits long. Each byte must be followed by an acknowledge bit; bytes are sent MSB first.

The acknowledge bit (A) is the ninth bit attached to any 8-bit data byte. An acknowledge bit is always generated by the receiving device (receiver) to inform the transmitter that the byte has been received. It is done by pulling the SDA line low during the ninth clock pulse after each 8-bit data byte.

The nonacknowledge bit (\bar{A}) is the ninth bit attached to any 8-bit data byte. A nonacknowledge bit is always generated by the receiving device (receiver) to inform the transmitter that the byte has not been received. It is done by leaving the SDA line high during the ninth clock pulse after each 8-bit data byte.

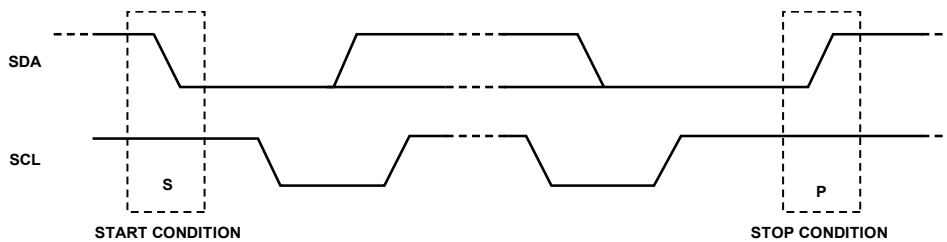

Figure 56. Start and Stop Conditions

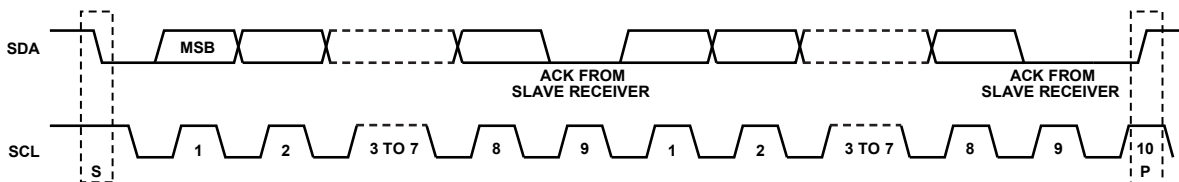

Figure 57. Acknowledge Bit

Data Transfer Process

The master initiates data transfer by asserting a start condition. This indicates that a data stream follows. All I²C slave devices connected to the serial bus respond to the start condition.

The master then sends an 8-bit address byte over the SDA line, consisting of a 7-bit slave address (MSB first) plus an R/W bit. This bit determines the direction of the data transfer, that is, whether data is written to or read from the slave device (0 = write, 1 = read).

The peripheral whose address corresponds to the transmitted address responds by sending an acknowledge bit. All other devices on the bus remain idle while the selected device waits for data to be read from or written to it. If the R/W bit is 0, the master (transmitter) writes to the slave device (receiver). If the R/W bit is 1, the master (receiver) reads from the slave device (transmitter).

The format for these commands is described in the Data Transfer Format section.

Data is then sent over the serial bus in the format of nine clock pulses, one data byte (eight bits) from either master (write mode) or slave (read mode) followed by an acknowledge bit from the receiving device. The number of bytes that can be transmitted

per transfer is unrestricted. In write mode, the first two data bytes immediately after the slave address byte are the internal memory (control registers) address bytes, with the high address byte first. This addressing scheme gives a memory address of up to $2^{16} - 1 = 65,535$. The data bytes after these two memory address bytes are register data written to or read from the control registers. In read mode, the data bytes after the slave address byte are register data written to or read from the control registers.

When all data bytes are read or written, stop conditions are established. In write mode, the master (transmitter) asserts a stop condition to end data transfer during the 10th clock pulse following the acknowledge bit for the last data byte from the slave device (receiver). In read mode, the master device (receiver) receives the last data byte from the slave device (transmitter) but does not pull SDA low during the ninth clock pulse. This is known as a nonacknowledge bit. By receiving the nonacknowledge bit, the slave device knows that the data transfer is finished and enters idle mode. The master then takes the data line low during the low period before the 10th clock pulse, and high during the 10th clock pulse to assert a stop condition.

A start condition can be used in place of a stop condition. Furthermore, a start or stop condition can occur at any time, and partially transferred bytes are discarded.

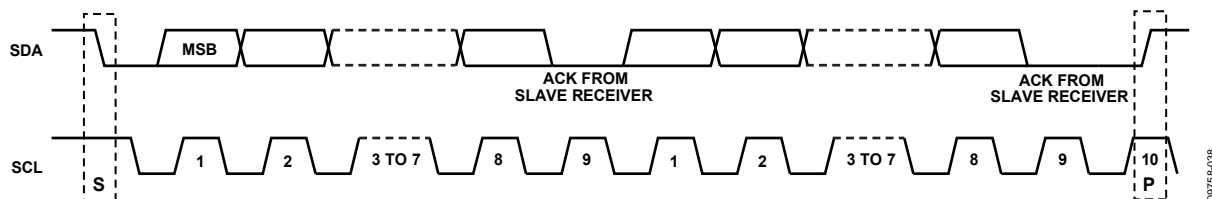

Figure 58. Data Transfer Process (Master Write Mode, 2-Byte Transfer)

09758-038

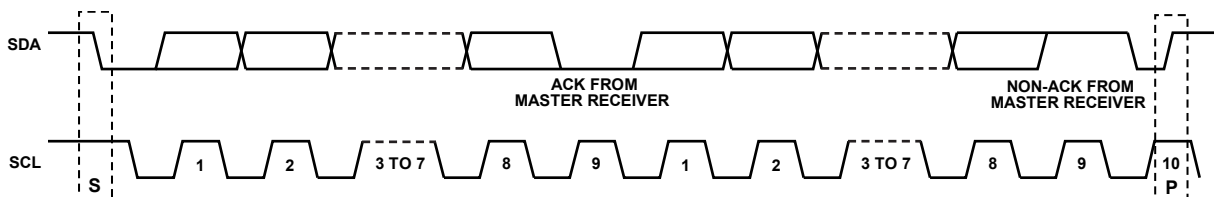

Figure 59. Data Transfer Process (Master Read Mode, 2-Byte Transfer)

09758-039

Data Transfer Format

Write byte format—the write byte protocol is used to write a register address to the RAM starting from the specified RAM address.

S	Slave address	\overline{W}	A	RAM address high byte	A	RAM address low byte	A	RAM Data 0	A	RAM Data 1	A	RAM Data 2	A	P
---	---------------	----------------	---	-----------------------	---	----------------------	---	------------	---	------------	---	------------	---	---

Send byte format—the send byte protocol is used to set up the register address for subsequent reads.

S	Slave address	\overline{W}	A	RAM address high byte	A	RAM address low byte	A	P
---	---------------	----------------	---	-----------------------	---	----------------------	---	---

Receive byte format—the receive byte protocol is used to read the data byte(s) from RAM starting from the current address.

S	Slave address	R	A	RAM Data 0	A	RAM Data 1	A	RAM Data 2	\overline{A}	P
---	---------------	---	---	------------	---	------------	---	------------	----------------	---

Read byte format—the combined format of the send byte and the receive byte.

S	Slave Address	\overline{W}	A	RAM Address High Byte	A	RAM Address Low Byte	A	Sr	Slave Address	R	A	RAM Data 0	A	RAM Data 1	A	RAM Data 2	\overline{A}	P
---	---------------	----------------	---	-----------------------	---	----------------------	---	----	---------------	---	---	------------	---	------------	---	------------	----------------	---

I²C Serial Port Timing

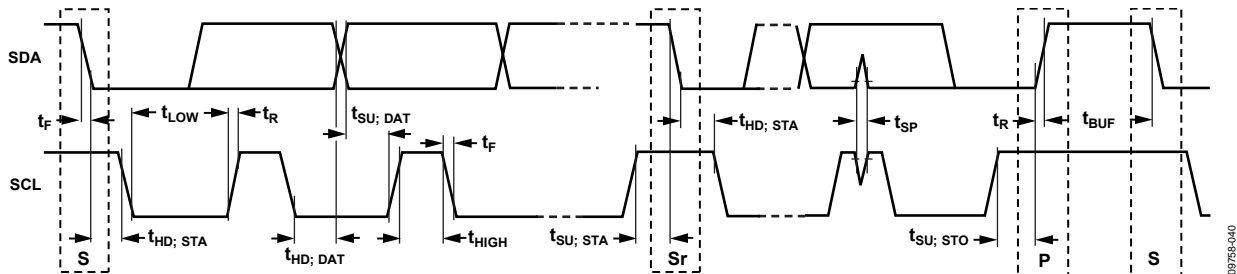

Figure 60. I²C Serial Port Timing

Table 30. I²C Timing Definitions

Parameter	Description
f_{SCL}	Serial clock
t_{BUF}	Bus free time between stop and start conditions
$t_{HD; STA}$	Repeated hold time start condition
$t_{SU; STA}$	Repeated start condition setup time
$t_{SU; STO}$	Stop condition setup time
$t_{HD; DAT}$	Data hold time
$t_{SU; DAT}$	Date setup time
t_{LOW}	SCL clock low period
t_{HIGH}	SCL clock high period
t_R	Minimum/maximum receive SCL and SDA rise time
t_F	Minimum/maximum receive SCL and SDA fall time
t_{SP}	Pulse width of voltage spikes that must be suppressed by the input filter

PROGRAMMING THE I/O REGISTERS

The register map spans an address range from 0x0000 through 0x0E3C. Each address provides access to 1 byte (eight bits) of data. Each individual register is identified by its four-digit hexadecimal address (for example, Register 0x0A10). In some cases, a group of addresses collectively defines a register.

In general, when a group of registers defines a control parameter, the LSB of the value resides in the D0 position of the register with the lowest address. The bit weight increases right to left, from the lowest register address to the highest register address.

Note that the EEPROM storage sequence registers (Address 0x0E10 to Address 0x0E3C) are an exception to the above convention (see the EEPROM Instructions section).

BUFFERED/ACTIVE REGISTERS

There are two copies of most registers: buffered and active. The value in the active registers is the one that is in use. The buffered registers are the ones that take effect the next time the user writes 0x01 to the I/O update register (Register 0x0005). Buffering the registers allows the user to update a group of registers (like the digital loop filter coefficients) at the same time, which avoids the potential of unpredictable behavior in the device. Registers with an L in the option column are live, meaning that they take effect the moment the serial port transfers that data byte.

AUTOCLEAR REGISTERS

An A in the option column of the register map identifies an autoclear register. Typically, the active value for an autoclear register takes effect following an I/O update. The bit is cleared by the internal device logic upon completion of the prescribed action.

REGISTER ACCESS RESTRICTIONS

Read and write access to the register map may be restricted depending on the register in question, the source and direction of access, and the current state of the device. Each register can be classified into one or more access types. When more than one type applies, the most restrictive condition is the one that applies.

When access is denied to a register, all attempts to read the register return a 0 byte, and all attempts to write to the register are ignored. Access to nonexistent registers is handled in the same way as for a denied register.

Regular Access

Registers with regular access do not fall into any other category. Both read and write access to registers of this type can be from either the serial ports or the EEPROM controller. However, only one of these sources can have access to a register at any given time (access is mutually exclusive). When the EEPROM controller is active, in either load or store mode, it has exclusive access to these registers.

Read-Only Access

An R in the option column of the register map identifies read-only registers. Access is available at all times, including when the EEPROM controller is active. Note that read-only registers (R) are inaccessible to the EEPROM, as well.

Exclusion from EEPROM Access

An E in the option column of the register map identifies a register with contents that are inaccessible to the EEPROM. That is, the contents of this type of register cannot be transferred directly to the EEPROM or vice versa. Note that read-only registers (R) are inaccessible to the EEPROM, as well.

THERMAL PERFORMANCE

Table 31. Thermal Parameters for the 64-Lead LFCSP Package

Symbol	Thermal Characteristic Using a JEDEC51-7 Plus JEDEC51-5 2S2P Test Board ¹	Value ²	Unit
θ_{JA}	Junction-to-ambient thermal resistance, 0.0 m/sec airflow per JEDEC JESD51-2 (still air)	21.7	°C/W
θ_{JMA}	Junction-to-ambient thermal resistance, 1.0 m/sec airflow per JEDEC JESD51-6 (moving air)	18.9	°C/W
θ_{JMA}	Junction-to-ambient thermal resistance, 2.5 m/sec airflow per JEDEC JESD51-6 (moving air)	16.9	°C/W
θ_{JB}	Junction-to-board thermal resistance, 0.0 m/sec airflow per JEDEC JESD51-8 (still air)	11.3	°C/W
θ_{JC}	Junction-to-case thermal resistance (die-to-heat sink) per MIL-Std 883, Method 1012.1	1.2	°C/W
Ψ_{JT}	Junction-to-top-of-package characterization parameter, 0 m/sec airflow per JEDEC JESD51-2 (still air)	0.1	°C/W

¹ The exposed pad on the bottom of the package must be soldered to ground to achieve the specified thermal performance.

² Results are from simulations. The PCB is a JEDEC multilayer type. Thermal performance for actual applications requires careful inspection of the conditions in the application to determine if they are similar to those assumed in these calculations.

The AD9558 is specified for a case temperature (T_{CASE}). To ensure that T_{CASE} is not exceeded, an airflow source can be used. Use the following equation to determine the junction temperature on the application PCB:

$$T_J = T_{CASE} + (\Psi_{JT} \times PD)$$

where:

T_J is the junction temperature (°C).

T_{CASE} is the case temperature (°C) measured by the user at the top center of the package.

Ψ_{JT} is the value as indicated in Table 31.

PD is the power dissipation (see Table 3).

Values of θ_{JA} are provided for package comparison and PCB design considerations. θ_{JA} can be used for a first-order approximation of T_J by the equation

$$T_J = T_A + (\theta_{JA} \times PD)$$

where T_A is the ambient temperature (°C).

Values of θ_{JC} are provided for package comparison and PCB design considerations when an external heat sink is required.

Values of θ_{JB} are provided for package comparison and PCB design considerations.

POWER SUPPLY PARTITIONS

The AD9558 power supplies are divided into four groups: DVDD3, DVDD, AVDD3, and AVDD. All power and ground pins must be connected, even if certain blocks of the chip are powered down.

This section recommends the use of ferrite beads. Most users report that the use of bypass capacitors together with ferrite beads is the best arrangement, although some have reported that ferrite beads alone are superior.

RECOMMENDED CONFIGURATION FOR 3.3 V SWITCHING SUPPLY

A popular power supply arrangement is to power the AD9558 with the output of a 3.3 V switching power supply.

When the AD9558 is powered using 3.3 V switching power supplies, all of the 3.3 V supplies can be connected to the 3.3 V switcher output, and a 0.1 μ F bypass capacitor must be placed adjacent to each 3.3 V power supply pin.

Use of Ferrite Beads on 3.3 V Supplies

To ensure the best output to output isolation when using the 3.3 V CMOS output driver mode, use one ferrite bead each for Pin 25 and Pin 26. However, a ferrite bead is not needed if 3.3 V output driver mode is not used. However, the 3.3 V power supply must still be connected to these pins even if the mode is not used.

CONFIGURATION FOR 1.8 V SUPPLY

When 1.8 V supplies are preferred, it is recommended that an LDO regulator, such as the ADP222, be used to generate the 1.8 V supply from the 3.3 V supply.

The ADP222 offers excellent power supply rejection in a small (2 mm \times 2 mm) package. It has two 1.8 V outputs. One output can be used for the DVDD pins (Pin 6, Pin 34, and Pin 35), and the other output can drive the AVDD pins.

The ADP7104 is another good choice for converting 3.3 V to 1.8 V. The close-in noise of the ADP7104 is lower than that of the ADP222; therefore, it may be better suited for applications where close-in phase noise is critical and the AD9558 DPLL loop bandwidth is <50 Hz. In such cases, all 1.8 V supplies can be connected to one ADP7104.

Use of Ferrite Beads on 1.8 V Supplies

To ensure the best output-to-output isolation, use one ferrite bead for each of the following AVDD pins: Pin 12, Pin 17, Pin 22, Pin 29, and Pin 30. The ferrite beads must be placed in between the 1.8 V LDO output and each pin listed previously. Ferrite beads that have low (<0.7 Ω) dc resistance and approximately 600 Ω impedance at 100 MHz are suitable for this application.

Pin 6 and Pin 56 are 1.8 V digital supplies, and while they are not susceptible to external noise, they are themselves a source of digital noise. Therefore, a ferrite bead is recommended for each of these pins. Pin 55 and Pin 56 can be joined together.

See Table 2 for the current consumed by each group. See Figure 20, Figure 21, and Figure 22 for information on the power consumption vs. output frequency.

PIN PROGRAM FUNCTION DESCRIPTION

The AD9558 supports both hard pin and soft pin program function with the on-chip ROM containing the predefined configurations. When a pin program function is enabled and initiated, the selected predefined configuration is transferred from the ROM to the corresponding registers to configure the device into the desired state.

OVERVIEW OF ON-CHIP ROM FEATURES

Input/Output Frequency Translation Configuration

The AD9558 has one on-chip ROM that contains a total of 256 different input-output frequency translation configurations for independent selection of 16 input frequencies and 16 output frequencies. Each input/output frequency translation configuration assumes that all input frequencies are the same and all the output frequencies are the same. Each configuration reprograms the following registers/parameters:

- Reference input period register
- Reference divider R register
- Digital PLL feedback divider register (Fractional Part FRAC1, Modulus Part MOD1 and Integer Part N1) free run
- Tuning word register
- Output PLL feedback divider N2 register
- RF divider register
- Clock distribution channel divider register

All configurations are set to support one single system clock frequency as 786.432 MHz (16× the default 49.152 MHz system clock reference frequency).

Four Different System Clock PLL Configurations

- REF = 49.152 MHz XO (×2 on, N = 8)
- REF = 49.152 MHz XTAL (×2 on, N = 8)
- REF = 24.756 MHz XTAL (×2 on, N = 16)
- REF = 98.304 MHz XO (×2 off, N = 8)

Four Different DPLL Loop Bandwidths

- 1 Hz, 10 Hz, 50 Hz, 100 Hz

DPLL Phase Margin

- Normal phase margin (70°)
- High phase margin (88.5°)

The ROM also contains an APLL VCO calibration bit. This bit is used to program Register 0x0405, Bit 0 (from 0) to 1 to generate a low-high transition to automatically initiate APLL VCO calibration.

Table 32. Preset Input Frequencies for Hard Pin and Soft Pin Programming

Freq ID	Frequency (MHz)	Frequency Description	Hard Pin Program PINCONTROL = High			Soft Pin Program PINCONTROL = Low Register 0x0C01[3:0]			
			M5 Pin	M4 Pin	M0 Pin	B3	B2	B1	B0
0	0.008	8 kHz	0	0	0	0	0	0	0
1	19.44	19.44 MHz	0	0	½	0	0	0	1
2	25	25 MHz	0	0	1	0	0	1	0
3	125	125 MHz	0	½	0	0	0	1	1
4	156.7072	156.25 MHz × 1027/1024	0	½	½	0	1	0	0
5	622.08	622.08 MHz	0	½	1	0	1	0	1
6	625	625 MHz	0	1	0	0	1	1	0
7	644.53125	625 MHz × 33/32	0	1	½	0	1	1	0
8	657.421875	657.421875 MHz	0	1	1	1	0	0	1
9	660.184152	657.421875 MHz × 239/238	½	0	0	1	0	0	0
10	669.3266	622.08 MHz × 255/238	½	0	½	1	0	1	1
11	672.1627	622.08 MHz × 255/236	½	0	1	1	0	1	0
12	690.569	622.08 MHz × 255/236	½	½	0	1	1	0	1
13	693.48299	644.53125 MHz × 255/238	½	½	½	1	1	0	0
14	693.482991	644.53125 MHz × 255/237	½	½	1	1	1	1	1
15	698.81236	622.08 × 255/237	½	1	0	1	1	1	0

Table 33. Preset Output Frequencies for Hard Pin and Soft Pin Programming

Freq ID	Frequency (MHz)	Frequency Description	Hard Pin Program PINCONTROL = High			Soft Pin Program PINCONTROL = Low, Register 0x0C01[3:0]			
			M3	M2	M1	B7	B6	B5	B4
0	19.44	19.44 MHz	0	0	0	0	0	0	0
1	25	25 MHz	0	0	½	0	0	0	1
2	125	125 MHz	0	0	1	0	0	1	0
3	156.7071	156.25 MHz × 1027/1024	0	½	0	0	0	1	1
4	622.08	622.08 MHz	0	½	½	0	1	0	0
5	625	625 MHz	0	½	1	0	1	0	1
6	644.53125	625 MHz × 33/32	0	1	0	0	1	1	0
7	657.421875	657.421875 MHz	0	1	½		1	1	1
8	660.184152	657.421875 MHz × 239/238	0	1	1	1	0	0	0
9	666.5143	622.08 MHz × 255/238	½	0	0	1	0	0	1
10	669.3266	622.08 MHz × 255/237	½	0	½	1	0	1	0
11	672.1627	622.08 MHz × 255/236	½	0	1	1	0	1	1
12	690.5692	644.53125 MHz × 255/238	½	½	0	1	1	0	0
13	693.4830	644.53125 MHz × 255/237	½	½	½	1	1	0	1
14	698.8124	622.08 MHz × 255/237	½	½	1	1	1	1	0
15	704.380580	657.421875 MHz × 255/238	½	1	0	1	1	1	1

Table 34. System Clock Configuration in Hard Pin and Soft Pin Programming Modes

Freq ID	Frequency (MHz)	System Clock Configuration	Hard Pin Program PINCONTROL = High, IRQ Pin	Soft Pin Program PINCONTROL = Low, Register 0x0C02[1:0]		Equivalent System Clock PLL Register Settings
			IRQ Pin	Bit 1	Bit 0	
0	49.152	XTAL mode, doubler on, N = 8	0	0	0	0001, 0000, 1000
1	49.152	XTAL mode off, doubler on, N = 8	½	0	1	
2	24.576	XTAL mode, doubler on, N = 16	1	1	0	
3	98.304	XTAL mode off, doubler off, N = 8	N/A	1	1	

HARD PIN PROGRAMMING MODE

The state of the PINCONTROL pin at power-up controls whether or not the chip is in hard pin programming mode. Setting the PINCONTROL pin high disables the I²C protocol, although the register map can be accessed via the SPI protocol.

The M0, M5, and M4 pins select one of 16 input frequencies, and the M3 to M1 pins select one of 16 possible output frequencies. See Table 32 and Table 33 for details.

The system clock configuration is controlled by the state of the IRQ pin at startup (see Table 34 for details). The digital PLL loop bandwidth, reference input frequency accuracy tolerance ranges, and DPLL phase margin selection are not available in hard pin programming mode unless the user uses the serial port to change their default values.

When in hard pin programming mode, the user must set Register 0x0200, Bit 0 = 1 to activate the IRQ, REF status, and PLL lock status signals at the multifunction pins.

SOFT PIN PROGRAMMING OVERVIEW

The soft pin program function is controlled by a dedicated register section (Address 0x0C00 to Address 0x0C08). The purpose of soft pin program is to use the register bits to mimic the hard pins for the configuration section. When in soft pin program mode, both the SPI and I²Cs port are available.

- Address 0x0C00, Bit 0 enables accessibility to Address 0x0C01 and Address 0x0C02 (Soft Pin Section 1). This bit must be set in soft pin mode.
- Address 0x0C03, Bit 0 enables accessibility to Address 0x0C04 to Address 0x0C06 (Soft Pin Section 2). This bit must be set in soft pin mode.
- Address 0x0C01, Bits[3:0] select one of 16 input frequencies.
- Address 0x0C01, Bits[7:4] select one of 16 output frequencies.
- Address 0x0C02, Bits[1:0] select the system clock configuration.
- Address 0x0C06, Bits[1:0] select one of four input frequency tolerance ranges.
- Address 0x0C06, Bits[3:2] select one of four DPLL loop bandwidths.
- Address 0x0C06, Bit 4 selects the DPLL phase margin.
- Address 0x0C04, Bits[3:0] scales the REFA/REFB/REFC/REFD input frequency down by divide-by-1, divide-by-4, divide-by-8, divide-by-16 independently. For example, when Address 0x0C01, Bits[3:0] = 0101 to select input frequency as 622.08 MHz for all REFA/REFB/REFC/REFD, setting Address 0x0C04, Bits[1:0] = 0x01 scales down the REFA input frequency to 155.52 MHz (= 622.08 MHz/4). This is done by internally scaling the R divider for REFA up by 4× and the REFA period up by 4×.
- Address 0x0C05, Bits[3:0] scales the Channel 0/Channel 1/Channel 2/Channel 3 output frequency down by divide-by-1, divide-by-4, divide-by-8, or divide-by-16.

REGISTER MAP

Register addresses that are not listed in Table 35 are not used, and writing to those registers has no effect. The user must write the default value to sections of registers marked reserved. R means read only. A means autoclear. E means excluded from EEPROM loading. L means live (I/O update not required for register to take effect or for a read-only register to be updated).

Table 35. Register Map

Reg Addr (Hex)	Opt	Name	D7	D6	D5	D4	D3	D2	D1	D0	Def		
Serial Control Port Configuration and Device Identification													
0x0000	L, E	SPI control	SDO enable	LSB first/increment address	Soft reset	Reserved					00		
0x0000	L	I ² C control	Reserved		Soft reset	Reserved					00		
0x0004	L	Readback control	Reserved								Read buffer register	00	
0x0005	A, L	I/O update	Reserved								I/O update	00	
0x0006	L	User scratch pad	User scratch pad[7:0]									00	
0x0007	L	User scratch pad	User scratch pad[15:8]									00	
0x000A	R, L	Silicon rev	Silicon revision[7:0]									50	
0x000B	R, L	Reserved	Reserved									0F	
0x000C	R, L	Device ID	Clock part family ID[7:0]									01	
0x000D	R, L		Clock part family ID[15:8]									00	
System Clock													
0x0100		SYSCLK config PLL feedback divider	System clock N divider[7:0]									08	
0x0101			Reserved		Load from ROM (read-only)	SYSCLK XTAL enable	SYSCLK P divider[1:0]		SYSCLK doubler enable		09 or 19		
0x0102		Reserved	Reserved									00	
0x0103		SYSCLK period	Nominal system clock period (fs), Bits[7:0] (1 ns at 1 ppm accuracy)									0E	
0x0104			Nominal system clock period (fs), Bits[15:8] (1 ns at 1 ppm accuracy)									67	
0x0105			Reserved			Nominal system clock period (fs), Bits[20:16]						13	
0x0106		SYSCLK stability	System clock stability period (ms), Bits[7:0]									32	
0x0107			System clock stability period (ms), Bits[15:8]									00	
0x0108	A		Reserved		Reset SYSCLK stab timer (autoclear)	System clock stability period (ms), Bits[19:16] (not autoclearing)						00	
General Configuration													
0x0200		EN_MPIN	Reserved								Enable M pins and IRQ pin function	00	
0x0201		M0FUNC	Output/input	Function[6:0]								B0	
0x0202		M1FUNC	Output/input	Function[6:0]								B1	
0x0203		M2FUNC	Output/input	Function[6:0]								C0	
0x0204		M3FUNC	Output/input	Function[6:0]								C1	
0x0205		M4FUNC	Output/input	Function[6:0]								B2	
0x0206		M5func	Output/input	Function[6:0]								B3	
0x0207		M6FUNC	Output/input	Function[6:0]								C2	
0x0208		M7FUNC	Output/input	Function[6:0]								C3	
0x0209		IRQ pin output mode	Reserved			Status signal at IRQ pin[1:0]		Use IRQ pin for status signal	IRQ pin driver type[1:0]			1E	
0x020A		IRQ mask	Reserved		SYSCLK unlocked	SYSCLK locked	APLL unlocked	APLL locked	APLL calibration complete	APLL calibration started		00	
0x020B			Reserved			Pin program end	Sync distribution	Watchdog timer	EEPROM fault		EEPROM complete		00
0x020C			Switching	Closed	Free run	Holdover	Frequency unlocked	Frequency locked	Phase unlocked		Phase locked		00
0x020D			Reserved			History updated	Frequency unclamped	Frequency clamped	Phase slew unlimited		Phase slew limited		00
0x020E			Reserved	REFB validated	REFB fault cleared	REFB fault	Reserved	REFA validated	REFA fault cleared		REFA fault		00
0x020F			Reserved	REFD validated	REFD fault cleared	REFD fault	Reserved	REFC validated	REFC fault cleared		REFC fault		00

Reg Addr (Hex)	Opt	Name	D7	D6	D5	D4	D3	D2	D1	D0	Def		
0x0210		Watchdog Timer 1	Watchdog timer (ms), Bits[7:0]								00		
0x0211			Watchdog timer (ms), Bits[15:8]								00		
0x0300		Free run frequency TW	30-bit free run frequency tuning word[7:0]								11		
0x0301			30-bit free run frequency tuning word[15:8]								15		
0x0302			30-bit free run frequency tuning word[23:16]								64		
0x0303			Reserved	30-bit free run frequency tuning word[29:24]								1B	
0x0304		Digital oscillator control	Reserved		DCO 4-level output	Reserved (must be 1b)	Reserved			Reset SDM	10		
0x0305			Reserved								00		
0x0306		DPLL frequency clamp	Lower limit of pull-in range[7:0]								51		
0x0307			Lower limit of pull-in range[15:8]								B8		
0x0308			Reserved				Lower limit of pull-in range[19:16]				02		
0x0309			Upper limit of pull-in range[7:0]								3E		
0x030A			Upper limit of pull-in range[15:8]								0A		
0x030B			Reserved				Upper limit of pull-in range[19:16]				0B		
0x030C		Closed-loop phase lock offset (±0.5 ms)	Fixed phase lock offset (signed; ps), Bits[7:0]								00		
0x030D			Fixed phase lock offset (signed; ps), Bits[15:8]								00		
0x030E			Fixed phase lock offset (signed; ps), Bits[23:16]								00		
0x030F			Reserved	Fixed phase lock offset (signed; ps), Bits[29:24]								00	
0x0310			Incremental phase lock offset step size (ps/step), Bits[7:0] (up to 65.5 ns/step)								00		
0x0311			Incremental phase lock offset step size (ps/step), Bits[15:8] (up to 65.5 ns/step)								00		
0x0312		Phase slew rate limit	Phase slew rate limit (µs/sec), Bits[7:0] (315 µs/sec up to 65.536 ms/sec)								00		
0x0313			Phase slew rate limit (µs/sec), Bits[15:8] (315 µs/sec up to 65.536 ms/sec)								00		
0x0314		Holdover history	History accumulation timer (ms), Bits[7:0] (up to 65 seconds)								0A		
0x0315			History accumulation timer (ms), Bits[15:8] (up to 65 seconds)								00		
0x0316		History mode	Reserved			Single sample fallback	Persistent history	Incremental average			00		
0x0317	L	Base Loop Filter A coefficient set (high phase margin)	HPM Alpha-0[7:0]								8C		
0x0318	L		HPM Alpha-0[15:8]								AD		
0x0319	L		Reserved	HPM Alpha-1[6:0]								4C	
0x031A	L		HPM Beta-0[7:0]								F5		
0x031B	L		HPM Beta-0[15:8]								CB		
0x031C	L		Reserved	HPM Beta-1[6:0]								73	
0x031D	L		HPM Gamma-0[7:0]								24		
0x031E	L		HPM Gamma-0[15:8]								D8		
0x031F	L		Reserved	HPM Gamma-1[6:0]								59	
0x0320	L		HPM Delta-0[7:0]								D2		
0x0321	L		HPM Delta-0[15:8]								8D		
0x0322	L		Reserved	HPM Delta-1[6:0]								5A	
0x0323	L		Base loop Filter A coefficient set (normal phase margin of 70°)	NPM Alpha-0[7:0]								24	
0x0324	L			NPM Alpha-0[15:8]								8C	
0x0325	L			Reserved	NPM Alpha-1[6:0]								49
0x0326	L			NPM Beta-0[7:0]								55	
0x0327	L	NPM Beta-0[15:8]								C9			
0x0328	L	Reserved		NPM Beta-1[6:0]								7B	
0x0329	L	NPM Gamma-0[7:0]								9C			
0x032A	L	NPM Gamma-0[15:8]								FA			
0x032B	L	Reserved		NPM Gamma-1[6:0]								55	
0x032C	L	NPM Delta-0[7:0]								EA			
0x032D	L	NPM Delta-0[15:8]								E2			
0x032E	L	Reserved	NPM Delta-1[6:0]								57		
Output PLL (APLL)													
0x0400		APLL charge pump	Output PLL (APLL) charge pump[7:0]								81		
0x0401		APLL N divider	Output PLL (APLL) feedback N divider[7:0]								14		
0x0402			Reserved								00		
0x0403		APLL loop filter control	APLL loop filter control[7:0]								07		
0x0404			Reserved								Bypass internal R _{ZERO}		

Reg Addr (Hex)	Opt	Name	D7	D6	D5	D4	D3	D2	D1	D0	Def	
0x0405		APLL VCO control	Reserved (default: 0x2)				APLL locked controlled sync disable	Reserved			Manual APLL VCO (not autoclearing)	20
0x0406			Reserved									00
0x0407		RF divider	RF Divider 2[3:0]				RF Divider 1[3:0]					44
0x0408			Reserved			RF divider startup mode	Reserved	PD dual RF divider	PD RF Divider 2	PD RF Divider 1	02	

Output Clock Distribution

0x0500		Distribution output sync	Mask Channel 3 sync	Mask Channel 2 sync	Mask Channel 1 sync	Mask Channel 0 sync	Reserved	Sync source selection	Automatic sync mode		02	
0x0501		Channel 0	Enable 3.3 V CMOS driver	OUT0 format[2:0]			OUT0 polarity[1:0]		OUT0 drive strength	Enable OUT0	10	
0x0502			Channel 0 (M0) division ratio[7:0]									00
0x0503			Reserved				Channel 0 PD	Select RF Divider 2	Channel 0 (M0) division ratio[9:8]			00
0x0504		Reserved			Channel 0 divider phase[5:0]						00	
0x0505		Channel 1	Reserved	OUT1 format[2:0]			OUT1 polarity[1:0]		OUT1 drive strength	Enable OUT1	10	
0x0506			Reserved	OUT2 format[2:0]			OUT2 polarity[1:0]		OUT2 drive strength	Enable OUT2	10	
0x0507			Channel 1 (M1) division ratio[7:0]									03
0x0508		Reserved				Channel 1 PD	Select RF Divider 2	Channel 1 (M1) division ratio[9:8]			00	
0x0509		Reserved			Channel 1 divider phase[5:0]						00	
0x050A		Channel 2	Reserved	OUT3 format[2:0]			OUT3 polarity[1:0]		OUT3 drive strength	Enable OUT3	10	
0x050B			Reserved	OUT4 format[2:0]			OUT4 polarity[1:0]		OUT4 drive strength	Enable OUT4	10	
0x050C			Channel 2 (M2) division ratio[7:0]									00
0x050D		Reserved				Channel 2 PD	Select RF Divider 2	Channel 2 (M2) division ratio[9:8]			00	
0x050E		Reserved			Channel 2 divider phase[5:0]						00	
0x050F		Channel 3	Enable 3.3 V CMOS driver	OUT5 format[2:0]			OUT5 polarity[1:0]		OUT5 drive strength	Enable OUT5	10	
0x0510			Channel 3, Divider 1 (M3) division ratio[7:0]									03
0x0511			Reserved							Channel 3, Divider 1 (M3) division ratio[9:8]		00
0x0512			Channel 3, Divider 2 (M3b) division ratio[7:0]									00
0x0513			Reserved				Enable Channel 3 doubler	Channel 3 PD	Select RF Divider 2	Channel 3, Divider 2 (M3b) division ratio[9:8]		00
0x0514			Reserved			Channel 3, Divider 1 phase[5:0]						00
0x0515		Reserved			Channel 3, Divider 2 phase[5:0]						00	

Reference Inputs

0x0600		Reference power-down	Reserved				Reference power-down[3:0]				00	
0x0601		Reference logic type	REFD logic type[1:0]		REFC logic type[1:0]		REFB logic type[1:0]		REFA logic type[1:0]		00	
0x0602		Reference priority	REFD priority[1:0]		REFC priority[1:0]		REFB priority[1:0]		REFA priority[1:0]		00	
0x0603			Reserved									00

Frame Synchronization Mode

0x0640		Enable frame sync	Reserved						Enable FSYNC	00
0x0641		Frame sync options	Reserved			Validate FSYNC reference	FSYNC one shot	FSYNC arm method	Arm soft FSYNC	00

Profile A (for REFA)

0x0700	L	Reference period (up to 1.1 ms)	Nominal reference period (fs), Bits[7:0] (default: 51.44 ns = 1/(19.44 MHz) for default system clock setting)								C9
0x0701	L		Nominal period (fs), Bits[15:8]								EA
0x0702	L		Nominal period (fs), Bits[23:16]								10
0x0703	L		Nominal period (fs), Bits[31:24]								03
0x0704	L		Nominal period (fs), Bits[39:32]								00

Reg Addr (Hex)	Opt	Name	D7	D6	D5	D4	D3	D2	D1	D0	Def	
0x0705	L	Frequency tolerance	Inner tolerance (1 ppm), Bits[7:0] (for reference invalid to valid; 50% down to 1 ppm) (default: 5%)									14
0x0706	L		Inner tolerance (1 ppm), Bits[15:8] (for reference invalid to valid; 50% down to 1 ppm)									00
0x0707	L		Reserved			Inner tolerance, Bits[19:16]						0A
0x0708	L		Outer tolerance (1 ppm), Bits[7:0] (for reference valid to invalid; 50% down to 1 ppm) (default: 10%)									0A
0x0709	L		Outer tolerance (1 ppm), Bits[15:8] (for reference valid to invalid; 50% down to 1 ppm)									00
0x070A	L		Reserved			Outer tolerance, Bits[19:16]						00
0x070B	L	Validation	Validation timer (ms), Bits[7:0] (up to 65.5 seconds)									0A
0x070C	L		Validation timer (ms), Bits[15:8] (up to 65.5 seconds)									00
0x070D	L		Reserved									00
0x070E	L	Select base loop filter	Reserved								Select high PM base loop filter	00
0x070F	L	DPLL loop BW	Digital PLL loop BW scaling factor[7:0] (default: 0x01F4 = 50 Hz)									F4
0x0710	L		Digital PLL loop BW scaling factor[15:8]									01
0x0711	L		Reserved								BW scaling factor[16]	00
0x0712	L	DPLL R divider (20 bits)	R divider[7:0]									C5
0x0713	L		R divider[15:8]									00
0x0714	L		Reserved			Enable REFA divide-by-2		R divider[19:16]				00
0x0715		DPLL N divider (17 bits)	Digital PLL feedback divider—Integer Part N1[7:0]									6B
0x0716			Digital PLL feedback divider—Integer Part N1[15:8]									07
0x0717			Reserved								Digital PLL feedback divider—Integer Part N1[16]	00
0x0718		DPLL fractional feedback divider (23 bits)	Digital PLL fractional feedback divider—FRAC1[7:0]									04
0x0719			Digital PLL fractional feedback divider—FRAC1[15:8]									00
0x071A			Reserved	Digital PLL fractional feedback divider—FRAC1[22:16]								00
0x071B		DPLL fractional feedback divider modulus (23 bits)	Digital PLL feedback divider modulus—MOD1[7:0]									05
0x071C			Digital PLL feedback divider modulus—MOD1[15:8]									00
0x071D			Reserved	Digital PLL feedback divider modulus—MOD1[22:16]								00
0x071E	L	Lock detectors	Phase lock threshold (ps), Bits[7:0]									BC
0x071F	L		Phase lock threshold (ps), Bits[15:8]									02
0x0720	L		Phase lock fill rate[7:0]									0A
0x0721	L		Phase lock drain rate[7:0]									0A
0x0722	L		Frequency lock threshold[7:0]									BC
0x0723	L		Frequency lock threshold[15:8]									02
0x0724	L		Frequency lock threshold[23:16]									00
0x0725	L		Frequency lock fill rate[7:0]									0A
0x0726	L		Frequency lock drain rate[7:0]									0A
Profile B (for REFB)												
0x0740	L	Reference period (up to 1.1 ms)	Nominal period (fs), Bits[7:0] (default: 125 μs = 1/(8 kHz) for default system clock setting)									00
0x0741	L		Nominal period (fs), Bits[15:8]									A2
0x0742	L		Nominal period (fs), Bits[23:16]									94
0x0743	L		Nominal period (fs), Bits[31:24]									1A
0x0744	L		Nominal period (fs), Bits[39:32]									1D
0x0745	L	Frequency tolerance	Inner tolerance (1 ppm), Bits[7:0] (for reference invalid to valid; 50% down to 1 ppm) (default: 5%)									14
0x0746	L		Inner tolerance (1 ppm), Bits[15:8] (for reference invalid to valid; 50% down to 1 ppm)									00
0x0747	L		Reserved			Inner tolerance, Bits[19:16]						00
0x0748	L		Outer tolerance (1 ppm), Bits[7:0] (for reference valid to invalid; 50% down to 1 ppm) (default: 10%)									0A
0x0749	L		Outer tolerance (1 ppm), Bits[15:8] (for reference valid to invalid; 50% down to 1 ppm)									00
0x074A	L		Reserved			Outer tolerance, Bits[19:16]						00
0x074B	L	Validation	Validation timer (ms), Bits[7:0] (up to 65.5 seconds)									0A
0x074C	L		Validation timer (ms), Bits[15:8] (up to 65.5 seconds)									00
0x074D	L		Reserved									00
0x074E	L	Select base loop filter	Reserved								Select high PM base loop filter	00

Reg Addr (Hex)	Opt	Name	D7	D6	D5	D4	D3	D2	D1	D0	Def	
0x074F	L	DPLL loop BW	Digital PLL loop BW scaling factor[7:0] (default: 0x01F4 = 50 Hz)								F4	
0x0750	L		Digital PLL loop BW scaling factor[15:8]								01	
0x0751	L		Reserved								BW scaling factor[16]	00
0x0752	L	DPLL R divider (20 bits)	R divider[7:0]								00	
0x0753	L		R divider[15:8]								00	
0x0754	L		Reserved				Enable REFB divide-by-2		R divider[19:16]			00
0x0755		DPLL N divider (17 bits)	Digital PLL feedback divider—Integer Part N1[7:0]								1F	
0x0756			Digital PLL feedback divider—Integer Part N1[15:8]								5B	
0x0757			Reserved								Digital PLL feedback divider—Integer Part N1[16]	00
0x0758		DPLL fractional feedback divider (23 bits)	Digital PLL fractional feedback divider—FRAC1[7:0]								00	
0x0759			Digital PLL fractional feedback divider—FRAC1[15:8]								00	
0x075A			Reserved	Digital PLL fractional feedback divider—FRAC1[22:16]							00	
0x075B		DPLL fractional feedback divider modulus (23 bits)	Digital PLL feedback divider modulus—MOD1[7:0]								01	
0x075C			Digital PLL feedback divider modulus—MOD1[15:8]								00	
0x075D			Reserved	Digital PLL feedback divider modulus—MOD1[22:16]							00	
0x075E	L	Lock detectors	Phase lock threshold (ps), Bits[7:0]								BC	
0x075F	L		Phase lock threshold(ps), Bits[15:8]								02	
0x0760	L		Phase lock fill rate[7:0]								0A	
0x0761	L		Phase lock drain rate[7:0]								0A	
0x0762	L		Frequency lock threshold[7:0]								BC	
0x0763	L		Frequency lock threshold[15:8]								02	
0x0764	L		Frequency lock threshold[23:16]								00	
0x0765	L		Frequency lock fill rate[7:0]								0A	
0x0766	L		Frequency lock drain rate[7:0]								0A	
Profile C (for REFC)												
0x0780	L	Reference period (up to 1.1 ms)	Nominal period (fs), Bits[7:0] (default: 125 μ s = 1/(8 kHz) for default system clock setting)								C9	
0x0781	L		Nominal period (fs), Bits[15:8]								EA	
0x0782	L		Nominal period (fs), Bits[23:16]								10	
0x0783	L		Nominal period (fs), Bits[31:24]								03	
0x0784	L		Nominal period (fs), Bits[39:32]								00	
0x0785	L	Frequency tolerance	Inner tolerance (1 ppm), Bits[7:0] (for reference invalid to valid; 50% down to 1 ppm) (default: 5%)								14	
0x0786	L		Inner tolerance (1 ppm), Bits[15:8] (for reference invalid to valid; 50% down to 1 ppm)								00	
0x0787	L		Reserved				Inner tolerance, Bits[19:16]				00	
0x0788	L		Outer tolerance (1 ppm), Bits[7:0] (for reference valid to invalid; 50% down to 1 ppm) (default: 10%)								0A	
0x0789	L		Outer tolerance (1 ppm), Bits[15:8] (for reference valid to invalid; 50% down to 1 ppm)								00	
0x078A	L		Reserved				Outer tolerance, Bits[19:16]				00	
0x078B	L	Validation	Validation timer (ms), Bits[7:0] (up to 65.5 seconds)								0A	
0x078C	L		Validation timer (ms), Bits[15:8] (up to 65.5 seconds)								00	
0x078D	L		Reserved								00	
0x078E	L	Select base loop filter	Reserved								Select high PM base loop filter	00
0x078F	L	DPLL loop BW	Digital PLL loop BW scaling factor[7:0] (default: 0x01F4 = 50 Hz)								F4	
0x0790	L		Digital PLL loop BW scaling factor[15:8]								01	
0x0791	L		Reserved								BW scaling factor[16]	00
0x0792	L	DPLL R divider (20 bits)	R divider[7:0]								C5	
0x0793	L		R divider[15:8]								00	
0x0794	L		Reserved				Enable REFC divide-by-2		R divider[19:16]			00

Reg Addr (Hex)	Opt	Name	D7	D6	D5	D4	D3	D2	D1	D0	Def	
0x0795		DPLL N divider (17 bits)	Digital PLL feedback divider—Integer Part N1[7:0]								6B	
0x0796			Digital PLL feedback divider—Integer Part N1[15:8]								07	
0x0797			Reserved								Digital PLL feedback divider—Integer Part N1[16]	00
0x0798		DPLL fractional feedback divider (23 bits)	Digital PLL fractional feedback divider—FRAC1[7:0]								04	
0x0799			Digital PLL fractional feedback divider—FRAC1[15:8]								00	
0x079A			Reserved	Digital PLL fractional feedback divider—FRAC1[22:16]							00	
0x079B		DPLL fractional feedback divider modulus (23 bits)	Digital PLL feedback divider modulus—MOD1[7:0]								05	
0x079C			Digital PLL feedback divider modulus—MOD1[15:8]								00	
0x079D			Reserved	Digital PLL feedback divider modulus—MOD1[22:16]							00	
0x079E	L	Lock detectors	Phase lock threshold (ps), Bits[7:0]								BC	
0x079F	L		Phase lock threshold (ps), Bits[15:8]								02	
0x07A0	L		Phase lock fill rate[7:0]								0A	
0x07A1	L		Phase lock drain rate[7:0]								0A	
0x07A2	L		Frequency lock threshold[7:0]								BC	
0x07A3	L		Frequency lock threshold[15:8]								02	
0x07A4	L		Frequency lock threshold[23:16]								00	
0x07A5	L		Frequency lock fill rate[7:0]								0A	
0x07A6	L		Frequency lock drain rate[7:0]								0A	
DPLL Profile D (for REFD)												
0x07C0	L	Reference period (up to 1.1 ms)	Nominal reference period (fs), Bits[7:0] (default: 51.44 ns = 1/(19.44 MHz) for default system clock setting)								00	
0x07C1	L		Nominal period (fs), Bits[15:8]								A2	
0x07C2	L		Nominal period (fs), Bits[23:16]								94	
0x07C3	L		Nominal period (fs), Bits[31:24]								1A	
0x07C4	L		Nominal period (fs), Bits[39:32]								1D	
0x07C5	L	Tolerance	Inner tolerance (1 ppm), Bits[7:0] (for reference invalid to valid; 50% down to 1 ppm) (default: 5%)								14	
0x07C6	L		Inner tolerance (1 ppm), Bits[15:8] (for reference invalid to valid; 50% down to 1 ppm)								00	
0x07C7	L		Reserved	Inner tolerance, Bits[19:16]							00	
0x07C8	L		Outer tolerance (1 ppm), Bits[7:0] (for reference valid to invalid; 50% down to 1 ppm) (default: 10%)								0A	
0x07C9	L		Outer tolerance (1 ppm), Bits[15:8] (for reference valid to invalid; 50% down to 1 ppm)								00	
0x07CA	L	Reserved	Outer tolerance, Bits[19:16]							00		
0x07CB	L	Validation	Validation timer (ms), Bits[7:0] (up to 65.5 seconds)								0A	
0x07CC	L		Validation timer (ms), Bits[15:8] (up to 65.5 seconds)								00	
0x07CD	L		Reserved								00	
0x07CE	L	Select base loop filter	Reserved								Select high PM base loop filter	00
0x07CF	L	DPLL loop BW	Digital PLL loop BW scaling factor[7:0] (default: 0x01F4 = 50 Hz)								F4	
0x07D0	L		Digital PLL loop bandwidth BW scaling factor[15:8]								01	
0x07D1	L		Reserved								BW scaling factor[16]	00
0x07D2	L	DPLL R divider (20 bits)	R divider[7:0]								00	
0x07D3	L		R divider[15:8]								00	
0x07D4	L		Reserved	Enable REFD divide-by-2	R divider[19:16]						00	
0x07D5	L	DPLL N divider (17 bits)	Digital PLL feedback divider—Integer Part N1[7:0]								1F	
0x07D6	L		Digital PLL feedback divider—Integer Part N1[15:8]								5B	
0x07D7	L		Reserved								Digital PLL feedback divider—Integer Part N1[16]	00
0x07D8	L	DPLL fractional feedback divider (23 bits)	Digital PLL fractional feedback divider—FRAC1[7:0]								00	
0x07D9	L		Digital PLL fractional feedback divider—FRAC1[15:8]								00	
0x07DA	L		Reserved	Digital PLL fractional feedback divider—FRAC1[22:16]							00	

Reg Addr (Hex)	Opt	Name	D7	D6	D5	D4	D3	D2	D1	D0	Def
0x07DB	L	DPLL fractional feedback divider modulus (23 bits)	Digital PLL feedback divider modulus—MOD1[7:0]								01
0x07DC	L		Digital PLL feedback divider modulus—MOD1[15:8]								00
0x07DD	L		Reserved	Digital PLL feedback divider modulus—MOD1[22:16]							
0x07DE	L	Lock detectors	Phase lock threshold (ps), Bits[7:0]								BC
0x07DF	L		Phase lock threshold(ps), Bits[15:8]								02
0x07E0	L		Phase lock fill rate[7:0]								0A
0x07E1	L		Phase lock drain rate[7:0]								0A
0x07E2	L		Frequency lock threshold[7:0]								BC
0x07E3	L		Frequency lock threshold[15:8]								02
0x07E4	L		Frequency lock threshold[23:16]								00
0x07E5	L		Frequency lock fill rate[7:0]								0A
0x07E6	L		Frequency lock drain rate[7:0]								0A
Operational Controls											
0x0A00		Power-down	Soft reset exclude register map	DCO PD	SYSCLK PD	Ref input PD	TDC PD	APLL PD	Clock distribution PD	Full PD	00
0x0A01		Loop mode	Reserved	User holdover	User free run	REF switchover mode[2:0]			User ref in manual switchover mode		00
0x0A02		Cal/sync	Reserved						Soft sync clock distribution	Reserved	00
0x0A03	A	Clear/reset functions	Reserved	Clear LF	Clear CCI	Reserved	Clear auto sync	Clear TW history	Clear all IRQs	Clear watchdog	00
0x0A04	A	IRQ clearing	Reserved	Reserved	SYSCLK unlocked	SYSCLK locked	APLL unlocked	APLL locked	APLL calibration ended	APLL calibration started	00
0x0A05	A		Reserved			Pin program end	Sync clock distribution	Watchdog timer	EEPROM fault	EEPROM complete	00
0x0A06	A		Switching	Closed	Free run	Holdover	Frequency unlocked	Frequency locked	Phase unlocked	Phase locked	00
0x0A07	A		Reserved			History updated	Frequency unclamped	Frequency clamped	Phase slew unlimited	Phase slew limited	00
0x0A08	A		Reserved	REFB validated	REFB fault cleared	REFB fault	Reserved	REFA validated	REFA fault cleared	REFA fault	00
0x0A09	A		Reserved	REFD validated	REFD fault cleared	REFD fault	Reserved	REFC validated	REFC fault cleared	REFC fault	00
0x0A0A	A	Increment phase offset	Reserved					Reset phase offset	Decrement phase offset	Increment phase offset	00
0x0A0B	A	Manual reference validation	Reserved				Force Timeout D	Force Timeout C	Force Timeout B	Force Timeout A	00
0x0A0C		Manual reference invalidation	Reserved				REF Mon Override D	REF Mon Override C	REF Mon Override B	REF Mon Override A	00
0x0A0D		Static reference validation	Reserved				REF Mon Bypass D	REF Mon Bypass C	REF Mon Bypass B	REF Mon Bypass A	00
Quick In-Out Frequency Soft Pin Configuration											
0x0C00	L, E	Enable Soft Pin Section 1	Reserved							Enable Soft Pin Section 1	00
0x0C01	L, E	Soft Pin Section 1	Output frequency selection[3:0]				Input frequency selection[3:0]				00
0x0C02	L, E		Reserved						SYSCLK PLL REF selection[1:0]		00
0x0C03	L, E	Enable Soft Pin Section 2	Reserved							Enable Soft Pin Section 2	00
0x0C04	L, E	Soft Pin Section 2	REFD frequency scale[1:0]		REFC frequency scale[1:0]		REFB frequency scale[1:0]		REFA frequency scale[1:0]		00
0x0C05	L, E		Channel 3 output frequency scale[1:0]		Channel 2 output frequency scale[1:0]		Channel 1 output frequency scale[1:0]		Channel 0 output frequency scale[1:0]		00
0x0C06	L, E		Reserved			Select high PM base loop filter	DPLL BW[1:0]		REF tolerance[1:0]		00
0x0C07	L, A, E		Reserved								Soft pin start transfer
0x0C08	L, E	Reserved								Soft pin reset	00

Reg Addr (Hex)	Opt	Name	D7	D6	D5	D4	D3	D2	D1	D0	Def	
Read-Only Status (Accessible During EEPROM Transactions)												
0x0D00	R, L	EEPROM	Reserved				Pin program ROM load process	Fault detected	Load in progress	Save in progress		N/A
0x0D01	R, L	SYSCLK and PLL status	Raw SYSCLK lock detect	DPLL_APLL_Lock	All PLLs locked	APLL VCO status	APLL calibration in progress	APLL lock	SYSCLK stable	SYSCLK lock detect	N/A	
0x0D02	R, L	IRQ monitor events	Reserved		SYSCLK unlocked	SYSCLK locked	APLL unlocked	APLL lock detect	APLL calibration ended	APLL calibration started	N/A	
0x0D03	R, L		Reserved			Pin program end	Output distribution sync	Watchdog timer	EEPROM fault	EEPROM complete	N/A	
0x0D04	R, L		Switching	Closed	Free run	Holdover	Frequency unlocked	Frequency locked	Phase unlocked	Phase locked	N/A	
0x0D05	R, L		Reserved			History updated	Frequency unclamped	Frequency clamped	Phase slew unlimited	Phase slew limited	N/A	
0x0D06	R, L		Reserved	REFB validated	REFB fault cleared	REFB fault	Reserved	REFA validated	REFA fault cleared	REFA fault	N/A	
0x0D07	R, L		Reserved	REFD validated	REFD fault cleared	REFD fault	Reserved	REFC validated	REFC fault cleared	REFC fault	N/A	
0x0D08	R		DPLL	Reserved	Offset slew limiting	Frequency lock	Phase lock	Loop switching	Holdover	Active	Free run	N/A
0x0D09	R	Reserved		Frequency clamped	History available	Reserved	Active reference priority	Current active reference		N/A		
0x0D0A	R	Reserved									N/A	
0x0D0B	R	REFA/REFB	B valid	B fault	B fast	B slow	A valid	A fault	A fast	A slow	N/A	
0x0D0C	R	REFC/REFD	D valid	D fault	D fast	D slow	C valid	C fault	C fast	C slow	N/A	
0x0D0D	R	Holdover history	Tuning word readback[31:0]								N/A	
0x0D0E	R		N/A									
0x0D0F	R		N/A									
0x0D10	R		N/A									
0x0D11	R	Lock detector phase tub	Phase tub[7:0]				Phase tub[11:8]				N/A	
0x0D12	R		Reserved				Phase tub[11:8]				N/A	
0x0D13	R	Lock detector frequency tub	Frequency tub[7:0]				Frequency tub[11:8]				N/A	
0x0D14	R		Reserved				Frequency tub[11:8]				N/A	
Nonvolatile Memory (EEPROM) Control												
0x0E00	E, L	Write protect	Reserved						Write enable		00	
0x0E01	E, L	Condition	Reserved				Conditional value[3:0]				00	
0x0E02	A, E, L	Save	Reserved						Save to EEPROM		00	
0x0E03	A, E, L	Load	Reserved						Load from EEPROM		00	
EEPROM Storage Sequence												
0x0E10	E, L	EEPROM ID	Data: two bytes								01	
0x0E11	E, L		Address: 0x0006								00	
0x0E12	E, L										06	
0x0E13	E, L	System clock	Data: nine bytes								08	
0x0E14	E, L		Address: 0x0100								01	
0x0E15	E, L										00	
0x0E16	E, L	I/O update	Action: I/O update								80	
0x0E17	E, L	General	Data: 18 bytes								11	
0x0E18	E, L		Address: 0x0200								02	
0x0E19	E, L										00	
0x0E1A	E, L	DPLL	Data: 47 bytes								2E	
0x0E1B	E, L		Address: 0x0300								03	
0x0E1C	E, L										00	
0x0E1D	E, L	APLL	Data: nine bytes								08	
0x0E1E	E, L		Address: 0x0400								04	
0x0E1F	E, L										00	
0x0E20	E, L	Clock distribution	Data: 22 bytes								15	
0x0E21	E, L		Address: 0x0500								05	
0x0E22	E, L										00	
0x0E23	E, L	I/O update	Action: I/O update								80	

Reg Addr (Hex)	Opt	Name	D7	D6	D5	D4	D3	D2	D1	D0	Def	
0x0E24	E, L	Reference inputs	Data: four bytes									03
0x0E25	E, L		Address: 0x0600									06
0x0E26	E, L											00
0x0E27	E, L		Data: two bytes									01
0x0E28	E, L		Address: 0x0640									06
0x0E29	E, L											40
0x0E2A	E, L	Profile REFA	Data: 39 bytes									26
0x0E2B	E, L		Address: 0x0700									07
0x0E2C	E, L											00
0x0E2D	E, L	Profile REFB	Data: 39 bytes									26
0x0E2E	E, L		Address: 0x0740									07
0x0E2F	E, L											40
0x0E30	E, L	Profile REFC	Data: 39 bytes									26
0x0E31	E, L		Address: 0x0780									07
0x0E32	E, L											80
0x0E33	E, L	Profile REFD	Data: 39 bytes									26
0x0E34	E, L		Address: 0x07C0									07
0x0E35	E, L											C0
0x0E36	E, L	I/O update	Action: I/O update									80
0x0E37	E, L	Operational controls	Data: 14 bytes									0D
0x0E38	E, L		Address: 0x0A00									0A
0x0E39	E, L											00
0x0E3A	E, L	Calibrate APLL	Action: calibrate output PLL									A0
0x0E3B	E, L	I/O update	Action: I/O update									80
0x0E3C	E, L	End of data	Action: End of data									FF
0x0E3D to 0xE45	E, L	Unused	Unused (available for additional EEPROM instructions)									00

REGISTER MAP BIT DESCRIPTIONS

SERIAL PORT CONFIGURATION (REGISTER 0x0000 TO REGISTER 0x0005)

Table 36. Serial Configuration (Note that the Contents of Register 0x0000 are Not Stored to the EEPROM)

Address	Bits	Bit Name	Description
0x0000	7	SDO enable	Enables SPI port SDO pin. 1 = 4-wire (SDO pin enabled). 0 (default) = 3-wire.
	6	LSB first/increment address	Bit order for SPI port. 1 = least significant bit and byte first. Register addresses are automatically incremented in multibyte transfers. 0 (default) = most significant bit and byte first. Register addresses are automatically decremented in multibyte transfers.
	5	Soft reset	Device reset (invokes an EEPROM download or pin program ROM download if EEPROM or pin program is enabled. See the EEPROM and Pin Configuration and Function Descriptions sections for details.
	[4:0]	Reserved	Reserved.

Table 37. Readback Control

Address	Bits	Bit Name	Description
0x0004	[7:1]	Reserved	Reserved.
	0	Read buffer register	For buffered registers, serial port readback reads from actual (active) registers instead of the buffer. As with all live registers, an I/O update is not needed when setting this bit. 1 = reads buffered values that take effect on next assertion of I/O update. 0 (default) = reads values currently applied to the internal logic of the device.

Table 38. Soft I/O Update

Address	Bits	Bit Name	Description
0x0005	[7:1]	Reserved	Reserved.
	0	I/O update	Writing a 1 to this bit transfers the data in the serial I/O buffer registers to the internal control registers of the device. Unless a register is marked as live (as indicated by an L in the Opt column of the register map), the user must write to this bit before any register settings can take effect and before a read-only register can be updated with the most current value. This is an autoclearing bit.

Table 39. User Scratch Pad

Address	Bits	Bit Name	Description
0x0006	[7:0]	User scratch pad[7:0]	User programmable EEPROM ID registers. These registers enable users to write a unique code of their choosing to keep track of revisions to the EEPROM register loading. It has no effect on device operation. 0 = default.
0x0007	[7:0]	User scratch pad[15:8]	

SILICON REVISION (REGISTER 0x000A)

Table 40. Silicon Revision

Address	Bits	Bit Name	Description
0x000A	[7:0]	Silicon revision	This read-only register identifies the revision level of the AD9558 .

CLOCK PART SERIAL ID (REGISTER 0x000C TO REGISTER 0x000D)

Table 41. Clock Part Family ID

Address	Bits	Bit Name	Description
0x000C	[7:0]	Clock part family ID[7:0]	This read-only register (along with Register 0x000D) uniquely identifies an AD9557 or AD9558 . No other device in the Analog Devices AD95xx family has a value of 0x0001 in these two registers. Default: 0x01 for the AD9557 and AD9558 .
0x000D	[7:0]	Clock part family ID[15:8]	This register is a continuation of Register 0x000C. Default: 0x00 for the AD9557 and AD9558 .

SYSTEM CLOCK (REGISTER 0x0100 TO REGISTER 0x0108)**Table 42. System Clock PLL Feedback Divider (N3 Divider)**

Address	Bits	Bit Name	Description
0x0100	[7:0]	SYSClk N3 divider	System clock PLL feedback divider value: $4 \leq N3 \leq 255$ (default: 0x08).

Table 43. SYSClk Configuration

Address	Bits	Bit Name	Description
0x0101	[7:5]	Reserved	Reserved.
	4	Load from ROM (read only)	This read-only bit is set if the PINCONTROL pin was high during the last power-on. 0 = The PINCONTROL pin was low at power-on (or reset). 1 = The PINCONTROL pin was high at power-on (or reset).
	3	SYSClk XTAL enable	Enables the crystal maintaining amplifier for the system clock input. 1 (default) = crystal mode (crystal maintaining amplifier enabled). 0 = external XO or other system clock source.
	[2:1]	SYSClk P divider	System clock input divider. 00 (default) = 1. 01 = 2. 10 = 4. 11 = 8.
	0	SYSClk doubler enable	Enable clock doubler on system clock input to reduce noise. 0 = disable. 1 (default) = enable.

Table 44. Nominal System Clock Period¹

Address	Bits	Bit Name	Description
0x0103	[7:0]	Nominal system clock period (fs)	System clock period, Bits[7:0]. Default: 0x0E.
0x0104	[7:0]		System clock period, Bits[15:8]. Default: 0x67.
0x0105	[7:5]	Reserved	Reserved.
	[4:0]	Nominal system clock period (fs)	System clock period, Bits[20:16]. Default: 0x13.

¹Note that the default setting for system clock period is 1.271566 ns, which is the period of 786.432 MHz (= 49.152 MHz × 16).

Table 45. System Clock Stability Period

Address	Bits	Bit Name	Description
0x0106	[7:0]	System clock stability period (ms)	System clock period, Bits[7:0]. Default: 0x32 (0x000032 = 50 ms).
0x0107	[7:0]		System clock period, Bits[15:8]. Default: 0x00.
0x0108	[7:5]	Reserved	Reserved.
	4	Reset SYSClk stability timer	This autoclearing bit resets the system clock stability timer.
	[3:0]	System clock stability period	System clock period, Bits[19:16]. Default: 0x00.

GENERAL CONFIGURATION (REGISTER 0x0200 TO REGISTER 0x0214)**Multifunction Pin Control (M0 to M7) and IRQ Pin Control (Register 0x0200 to Register 0x0209)**

Note that the default setting for the M0 to M5 multifunction pins and the IRQ is that of a 3-level logic input; M6 and M7 are unused inputs at startup. After startup, M0 to M7 are 2-level inputs or 2-level outputs, based on the settings of Register 0x0200 to Register 0x0208. Setting Bit 0 in Register 0x0200 to 1 enables M0 to M7 pin functionality.

Table 46. Multifunction Pin (M0 to M7) Control

Address	Bits	Bit Name	Description
0x0200	[7:1]	Reserved	Reserved.
	0	Enable M pins and IRQ pin function	0 (default) = disables the function of the M pins and IRQ pin control register (Address 0x0201 to Address 0x0209) and the M pins and IRQ pin are in 3-level logic input state. 1 = the M pins and IRQ pin are out of 3-level logic input state. Enables the function of the M pins and IRQ pin control register (Address 0x0201 to Address 0x0209).
0x0201	7	M0 output/input	In/out control for M0 pin. 0 = input (2-level logic control pin). 1 (default) = output (2-level logic status pin).
	[6:0]	M0 function	See Table 129 and Table 130. Default: 0xB0 = REFA valid.
0x0202	7	M1 output/input	In/out control for M1 pin (same as M0).
	[6:0]	M1 function	See Table 129 and Table 130. Default: 0xB1 = REFB valid.
0x0203	7	M2 output/input	In/out control for M2 pin (same as M0).
	[6:0]	M2 function	See Table 129 and Table 130. Default: 0xC0 = REFA active.
0x0204	7	M3 output/input	In/out control for M3 pin (same as M0).
	[6:0]	M3 function	See Table 129 and Table 130. Default: 0xC1 = REFB active.
0x0205	7	M4 output/input	In/out control for M3 pin (same as M0).
	[6:0]	M4 function	See Table 129 and Table 130. Default: 0xB2 = REFC valid.
0x0206	7	M5 output/input	In/out control for M3 pin (same as M0).
	[6:0]	M5 function	See Table 129 and Table 130. Default: 0xB3 = REFD valid.
0x0207	7	M6 output/input	In/out control for M3 pin (same as M0).
	[6:0]	M6 function	See Table 129 and Table 130. Default: 0xC2 = REFC active.
0x0208	7	M7 output/input	In/out control for M3 pin (same as M0).
	[6:0]	M7 function	See Table 129 and Table 130. Default: 0xC3 = REFD active.

Table 47. IRQ Pin Output Mode

Address	Bits	Bit Name	Description
0x0209	[7:5]	Reserved	Default: 000b
	[4:3]	Status signal at IRQ pin	This selection is valid only when Address 0x0209[2] = 1 00 = DPLL phase locked 01 = DPLL frequency locked 10 = system clock PLL locked 11 (default) = (DPLL phase locked) AND (system clock PLL locked) AND (APLL locked)
	2	Use IRQ pin for status signal	0 = uses IRQ pin to monitor IRQ event 1 (default) = uses IRQ pin to monitor internal status signals
	[1:0]	IRQ pin driver type	Select the output mode of the IRQ pin 00 = NMOS, open drain (requires an external pull-up resistor) 01 = PMOS, open drain (requires an external pull-down resistor) 10 (default) = CMOS, active high 11 = CMOS, active low

IRQ MASK (REGISTER 0x020A TO REGISTER 0x020F)

The IRQ mask register bits form a one-to-one correspondence with the bits of the IRQ monitor register (0x0D02 to 0x0D09). When set to Logic 1, the IRQ mask bits enable the corresponding IRQ monitor bits to indicate an IRQ event. The default for all IRQ mask bits is Logic 0, which prevents the IRQ monitor from detecting any internal interrupts.

Table 48. IRQ Mask for SYSCLK

Address	Bits	Bit Name	Description
0x020A	[7:6]	Reserved	Reserved
	5	SYSCLK unlocked	Enables IRQ for indicating a SYSCLK PLL state transition from locked to unlocked
	4	SYSCLK locked	Enables IRQ for indicating a SYSCLK PLL state transition from unlocked to locked
	3	APLL unlocked	Enables IRQ for indicating an APLL state transition from locked to unlocked
	2	APLL locked	Enables IRQ for indicating an APLL state transition from unlocked to locked
	1	APLL calibration complete	Enables IRQ for indicating that APLL (LCVCO) calibration has completed
	0	APLL calibration started	Enables IRQ for indicating that APLL (LCVCO) calibration has begun

Table 49. IRQ Mask for Distribution Sync, Watchdog Timer, and EEPROM

Address	Bits	Bit Name	Description
0x020B	[7:5]	Reserved	Reserved
	4	Pin program end	Enables IRQ for indicating successful completion of a pin program ROM load
	3	Sync distribution	Enables IRQ for indicating a distribution sync event
	2	Watchdog timer	Enables IRQ for indicating expiration of the watchdog timer
	1	EEPROM fault	Enables IRQ for indicating a fault during an EEPROM load or save operation
	0	EEPROM complete	Enables IRQ for indicating successful completion of an EEPROM load or save operation

Table 50. IRQ Mask for the Digital PLL

Address	Bits	Bit Name	Description
0x020C	7	Switching	Enables IRQ for indicating that the DPLL is switching to a new reference
	6	Closed	Enables IRQ for indicating that the DPLL has entered closed-loop operation
	5	Free run	Enables IRQ for indicating that the DPLL has entered free run mode
	4	Holdover	Enables IRQ for indicating that the DPLL has entered holdover mode
	3	Frequency unlocked	Enables IRQ for indicating that the DPLL lost frequency lock
	2	Frequency locked	Enables IRQ for indicating that the DPLL has acquired frequency lock
	1	Phase unlocked	Enables IRQ for indicating that the DPLL lost phase lock
	0	Phase locked	Enables IRQ for indicating that the DPLL has acquired phase lock

Table 51. IRQ Mask for History Update, Frequency Limit and Phase Slew Limit

Address	Bits	Bit Name	Description
0x020D	[7:5]	Reserved	Reserved
	4	History updated	Enables IRQ for indicating the occurrence of a tuning word history update
	3	Frequency unclamped	Enables IRQ for indicating a frequency limit state transition from clamped to unclamped
	2	Frequency clamped	Enables IRQ for indicating a state transition of the frequency limiter from unclamped to clamped
	1	Phase slew unlimited	Enables IRQ for indicating a state transition of the phase slew limiter from slew limiting to not slew limiting
	0	Phase slew limited	Enables IRQ for indicating a state transition of the phase slew limiter from not slew limiting to slew limiting

Table 52. IRQ Mask for Reference Inputs

Address	Bits	Bit Name	Description
0x020E	7	Reserved	Reserved
	6	REFB validated	Enables IRQ for indicating that REFB has been validated
	5	REFB fault cleared	Enables IRQ for indicating that REFB has been cleared of a previous fault
	4	REFB fault	Enables IRQ for indicating that REFB has been faulted
	3	Reserved	Reserved
	2	REFA validated	Enables IRQ for indicating that REFA has been validated
	1	REFA fault cleared	Enables IRQ for indicating that REFA has been cleared of a previous fault
	0	REFA fault	Enables IRQ for indicating that REFA has been faulted
0x020F	[7:0]	Reserved	Reserved

Table 53. Watchdog Timer 1¹

Address	Bits	Bit Name	Description
0x0210	[7:0]	Watchdog timer (ms)	Watchdog timer, Bits[7:0]; default: 0x00
0x0211	[7:0]		Watchdog timer, Bits[15:8]; default: 0x00

¹ Note that the watchdog timer is expressed in units of milliseconds (ms). The default value is 0 (disabled).

DPLL CONFIGURATION (REGISTER 0x0300 TO REGISTER 0x032E)

Table 54. Free Run Frequency Tuning Word¹

Address	Bits	Bit Name	Description
0x0300	[7:0]	30-bit free run frequency tuning word	Free run frequency tuning word, Bits[7:0]; default: 0x11
0x0301	[7:0]		Free run frequency tuning word, Bits[15:8]; default: 0x15
0x0302	[7:0]		Free run frequency tuning word, Bits[23:9]; default: 0x64
0x0303	[7:6]	Reserved	Reserved
	[5:0]	30-bit free run frequency word	Free run frequency tuning word, Bits[29:24]; default: 0x1B

¹ Note that the default free run tuning word is 0x1B641511, which is used for 8 kHz/19.44 MHz = 622.08 MHz translation.

Table 55. Digital Oscillator Control

Address	Bits	Bit Name	Description
0x0304	[7:6]	Reserved	Default: 00b
	5	DCO 4-level output	0 (default) = DCO 3-level output mode 1 = enables DCO 4-level output mode
	4	Reserved	Reserved (must be set to 1b)
	[3:0]	Reserved	Reserved (default: 0x0)

Table 56. DPLL Frequency Clamp

Address	Bits	Bit Name	Description
0x0306	[7:0]	Lower limit of pull-in range (expressed as a 20-bit frequency tuning word)	Lower limit pull-in range, Bits[7:0]. Default: 0x51.
0x0307	[7:0]		Lower limit pull-in range, Bits[15:8]. Default: 0xB8.
0x0308	[7:4]	Reserved	Default: 0x0.
	[3:0]	Lower limit of pull-in range	Lower limit pull-in range, Bits[19:16]. Default: 0x2.
0x0309	[7:0]	Upper limit of pull-in range (expressed as a 20-bit frequency tuning word)	Upper limit pull-in range, Bits[7:0]. Default: 0x3E.
0x030A	[7:0]		Upper limit pull-in range, Bits[15:8]. Default: 0x0A.
0x030B	[7:4]	Reserved	Default: 0x0.
	[3:0]	Upper limit of pull-in range	Upper limit pull-in range, Bits[19:16]. Default: 0xB.

Table 57. Fixed Closed-Loop Phase Lock Offset

Address	Bits	Bit Name	Description
0x030C	[7:0]	Fixed phase lock offset (signed; ps)	Fixed phase lock offset, Bits[7:0]. Default: 0x00.
0x030D	[7:0]		Fixed phase lock offset, Bits[15:8]. Default: 0x00.
0x030E	[7:0]		Fixed phase lock offset, Bits[23:16]. Default: 0x00.
0x030F	[7:6]	Reserved	Reserved; default: 0x0.
	[5:0]	Fixed phase lock offset (signed; ps)	Fixed phase lock offset, Bits[29:24]. Default: 0x00.

Table 58. Incremental Closed-Loop Phase Lock Offset Step Size¹

Address	Bits	Bit Name	Description
0x0310	[7:0]	Incremental phase lock offset step size (ps)	Incremental phase lock offset step size, Bits[7:0]. Default: 0x00. This controls the static phase offset of the DPLL while it is locked.
0x0311	[7:0]		Incremental phase lock offset step size, Bits[15:8]. Default: 0x00. This controls the static phase offset of the DPLL while it is locked.

¹ Note that the default incremental closed-loop phase lock offset step size value is 0x0000 = 0 (0 ns).

Table 59. Phase Slew Rate Limit

Address	Bits	Bit Name	Description
0x0312	[7:0]	Phase slew rate limit (μ s/sec)	Phase slew rate limit, Bits[7:0]. Default: 0x00. This register controls the maximum allowable phase slewing during transients and reference switching. The default phase slew rate limit is 0, or disabled. Minimum useful value is 310 μ s/sec.
0x0313	[7:0]		Phase slew rate limit, Bits[15:8]. Default: 0x00.

Table 60. History Accumulation Timer

Address	Bits	Bit Name	Description
0x0314	[7:0]	History accumulation timer (ms)	History accumulation timer bits[7:0]. Default: 0x0A. For Register 0x0314 and Register 0x0315, 0x000A = 10 ms. Maximum is 65 sec. This register controls the amount of tuning word averaging used to determine the tuning word used in holdover. Never program a timer value of zero. The default value is 0x000A = 10 decimal, which equates to 10 ms
0x0315	[7:0]		History accumulation timer bits[15:8]. Default: 0x00.

Table 61. History Mode

Address	Bits	Bit Name	Description
0x0316	[7:5]	Reserved	Reserved.
	4	Single sample fallback	Controls holdover history. If tuning word history is not available for the reference that was active just prior to holdover, then: 0 (default) = uses the free run frequency tuning word register value. 1 = uses the last tuning word from the DPLL.
	3	Persistent history	Controls holdover history initialization. When switching to a new reference: 0 (default) = clears the tuning word history. 1 = retain the previous tuning word history.
	[2:0]	Incremental average	History mode value from 0 to 7 (default: 0). When set to non-zero, causes the first history accumulation to update prior to the first complete averaging period. After the first full interval, updates occur only at the full period. 0 (default) = update only after the full interval has elapsed. 1 = update at 1/2 the full interval. 2 = update at 1/4 and 1/2 of the full interval. 3 = update at 1/8, 1/4, and 1/2 of the full interval. ... 7 = update at 1/256, 1/128, 1/64, 1/32, 1/16, 1/8, 1/4, and 1/2 of the full interval.

Table 62. Base Digital Loop Filter with High Phase Margin (PM = 88.5°, BW = 0.1 Hz, Third Pole Frequency = 10 Hz, N1 = 1)¹

Address	Bits	Bit Name	Description
0x0317	[7:0]	HPM Alpha-0 linear	Alpha-0 coefficient linear bits[7:0]. Default: 0x8C
0x0318	[7:0]		Alpha-0 coefficient linear bits[15:8]
0x0319	7	Reserved	Reserved
	[6:0]	HPM Alpha-1 exponent	Alpha-1 coefficient exponent bits[6:0]
0x031A	[7:0]	HPM Beta-0 linear	Beta-0 coefficient linear bits[7:0]
0x031B	[7:0]		Beta-0 coefficient linear bits[15:8]
0x031C	7	Reserved	Reserved
	[6:0]	HPM Beta-1 exponent	Beta-1 coefficient exponent bits[6:0]
0x031D	[7:0]	HPM Gamma-0 linear	Gamma-0 coefficient linear bits[7:0]
0x031E	[7:0]		Gamma-0 coefficient linear bits[15:8]
0x031F	7	Reserved	Reserved
	[6:0]	HPM Gamma-1 exponent	Gamma-1 coefficient exponent bits[6:0]
0x0320	[7:0]	HPM Delta-0 linear	Delta-0 coefficient linear bits[7:0]
0x0321	[7:0]		Delta-0 coefficient linear bits[15:8]
0x0322	7	Reserved	Reserved
	[6:0]	HPM Delta-1 exponent	Delta-1 coefficient exponent bits[6:0]

¹Note that the base digital loop filter coefficients (α , β , γ , and δ) have the following general form: $x(2^y)$, where x is the linear component and y is the exponential component of the coefficient. The value of the linear component (x) constitutes a fraction, where $0 \leq x \leq 1$. The exponential component (y) is a signed integer.

Table 63. Base Digital Loop Filter with Normal Phase Margin (PM = 70°, BW = 0.1 Hz, Third Pole Frequency = 2 Hz, N1 = 1)¹

Address	Bits	Bit Name	Description
0x0323	[7:0]	NPM Alpha-0 linear	Alpha-0 coefficient linear, Bits[7:0]
0x0324	[7:0]		Alpha-0 coefficient linear, Bits[15:8]
0x0325	7	Reserved	Reserved
	[6:0]	NPM Alpha-1 exponent	Alpha-1 coefficient exponent, Bits[6:0]
0x0326	[7:0]	NPM Beta-0 linear	Beta-0 coefficient linear, Bits[7:0]
0x0327	[7:0]		Beta-0 coefficient linear, Bits[15:8]
0x0328	7	Reserved	Reserved
	[6:0]	NPM Beta-1 exponent	Beta-1 coefficient exponent, Bits[6:0]
0x0329	[7:0]	NPM Gamma-0 linear	Gamma-0 coefficient linear, Bits[7:0]
0x032A	[7:0]		Gamma-0 coefficient linear, Bits[15:8]
0x032B	7	Reserved	Reserved
	[6:0]	NPM Gamma-1 exponent	Gamma-1 coefficient exponent, Bits[6:0]
0x032C	[7:0]	NPM Delta-0 linear	Delta-0 coefficient linear, Bits[7:0]
0x032D	[7:0]		Delta-0 coefficient linear, Bits[15:8]
0x032E	7	Reserved	Reserved
	[6:0]	NPM Delta-1 exponent	Delta-1 coefficient exponent, Bits[6:0]

¹Note that the digital loop filter base coefficients (α , β , γ , and δ) have the following general form: $x(2^y)$, where x is the linear component and y is the exponential component of the coefficient. The value of the linear component (x) constitutes a fraction, where $0 \leq x \leq 1$. The exponential component (y) is a signed integer.

OUTPUT PLL CONFIGURATION (REGISTER 0x0400 TO REGISTER 0x0408)

Table 64. Output PLL Setting¹

Address	Bits	Bit Name	Description				
0x0400	[7:0]	Output PLL (APLL) charge pump current	LSB = 3.5 μ A 00000001b = 1 \times LSB; 00000010b = 2 \times LSB; 11111111b = 255 \times LSB Default: 0x81 = 451 μ A CP current				
0x0401	[7:0]	APLL N divider	Division = 14 to 255 Default: 0x14 = divide-by-20				
0x0402	[7:0]	Reserved	Reserved; default: 0x00				
0x0403	[7:6]	APLL loop filter control	Pole 2 resistor R _{P2} ; default: 0x07				
			R_{P2} (Ω)	Bit 7	Bit 6		
			500 (default)	0	0		
			333	0	1		
	250	1	0				
	200	1	1				
	[5:3]			Zero resistor, R _{ZERO}			
				R_{ZERO} (Ω)	Bit 5	Bit 4	Bit 3
				1500 (default)	0	0	0
				1250	0	0	1
				1000	0	1	0
				930	0	1	1
				1250	1	0	0
1000				1	0	1	
750	1	1	0				
680	1	1	1				
[2:0]			Pole 1 C _{P1} .				
			C_{P1} (pF)	Bit 2	Bit 1	Bit 0	
			0	0	0	0	
			20	0	0	1	
			80	0	1	0	
			100	0	1	1	
			20	1	0	0	
			40	1	0	1	
			100	1	1	0	
			120 (default)	1	1	1	
0x0404	[7:1]	Reserved	Default: 0x00.				
	0	Bypass internal R _{ZERO}	0 (default) = uses the internal R _{ZERO} resistor. 1 = bypasses the internal R _{ZERO} resistor (makes R _{ZERO} = 0 and requires the use of a series external zero resistor).				
0x0405	[7:4]	Reserved	Default: 0x2.				
	3	APLL locked controlled sync	0 (default) = the clock distribution sync function is not enabled until the output PLL (APLL) is calibrated and locked. After APLL calibration and lock, the output clock distribution sync is armed, and the sync function for the clock outputs is under the control of Register 0x0500. 1 = overrides the lock detector state of the output PLL; allows Register 0x0500 to control the output sync function, regardless of the APLL lock status.				
	2	Reserved	Default: 0b.				
	1	APLL calibration reset	1 = resets the VCO calibration. (Reset occurs on low-to-high transition). 0 (default) = does nothing. This is not an autoclearing bit.				
	0	Manual APLL VCO calibration	1 = initiates VCO calibration. (Calibration occurs on low-to-high transition). 0 (default) = does nothing. This is not an autoclearing bit.				

¹Note that the default APLL loop BW is 180 kHz.

Table 65. Reserved

Address	Bits	Bit Name	Description
0x0406	[7:0]	Reserved	Default: 0x00

Table 66. RF Divider Setting

Address	Bits	Bit Name	Description
0x0407	[7:4]	RF Divider 2 division	0000/0001 = 3 0010 = 4 0011 = 5 0100 = 6 (default) 0101 = 7 0110 = 8 0111 = 9 1000 = 10 1001 = 11 1111 = RF Divider 2 reset state. If changing the RF Divider 2 without issuing an APLL VCO calibration, program this state (followed by an I/O update) before programming the new RF Divider 2 value (followed by an I/O update). Issue an I/O update by writing 0x01 to Register 0x0005. This step is unnecessary if issuing an APLL VCO calibration afterwards.
	[3:0]	RF Divider 1 division	0000/0001 = 3 0010 = 4 0011 = 5 0100 = 6 (default) 0101 = 7 0110 = 8 0111 = 9 1000 = 10 1001 = 11 1111 = RF Divider 1 reset state. If changing the RF Divider 1 without issuing an APLL VCO calibration, program this state (followed by an I/O update) before programming the new RF Divider 1 value (followed by an I/O update). Issue an I/O update by writing 0x01 to Register 0x0005. This step is unnecessary if issuing an APLL VCO calibration afterwards.
0x0408	[7:5]	Reserved	Reserved. Default: 000b
	4	RF divider start-up mode	0 (default) = RF dividers are held in power-down until the APLL feedback divider is detected, which ensures proper RF divider operation when exiting full power-down. 1 = RF dividers are not held in power-down until the APLL feedback divider is detected.
	3	Reserved	Reserved. Default: 0b
	2	PD dual RF divider	0 (default) = enables RF Divider 1 and RF Divider 2. 1 = powers down RF Divider 1 and RF Divider 2.
	1	PD RF Divider 2	0 = enables RF Divider 2. 1 (default) = powers down RF Divider 2.
	0	PD RF Divider 1	0 (default) = enables RF Divider 1. 1 = powers down RF Divider 1.

OUTPUT CLOCK DISTRIBUTION (REGISTER 0x0500 TO REGISTER 0x0515)

Table 67. Clock Distribution Output Synchronization Settings

Address	Bits	Bit Name	Description
0x0500	7	Mask Channel 3 sync	Masks the synchronous reset to the Channel 3 (M3) divider. 0 (default) = unmasked. The output drivers do not toggle until a SYNC pulse occurs. 1 = masked. Setting this bit asynchronously releases Channel 3 from the static SYNC state, thus allowing the Channel 3 divider to toggle. Channel 3 ignores all SYNC events while this bit is set. Setting this bit does not enable the output drivers connected to this channel. In addition, the output distribution sync also depends on the setting of Register 0x0405[3].
	6	Mask Channel 2 sync	Masks the synchronous reset to the Channel 2 (M2) divider. 0 (default) = unmasked. The output drivers do not toggle until a SYNC pulse occurs. 1 = masked. Setting this bit asynchronously releases Channel 2 from the static SYNC state, thus allowing the Channel 2 divider to toggle. Channel 2 ignores all SYNC events while this bit is set. Setting this bit does not enable the output drivers connected to this channel. In addition, the output distribution sync also depends on the setting of Register 0x0405[3].
	5	Mask Channel 1 sync	Masks the synchronous reset to the Channel 1 (M1) divider. 0 (default) = unmasked. The output drivers do not toggle until a SYNC pulse occurs. 1 = masked. Setting this bit asynchronously releases Channel 1 from the static SYNC state, thus allowing the Channel 1 divider to toggle. Channel 1 ignores all SYNC events while this bit is set. Setting this bit does not enable the output drivers connected to this channel. In addition, the output distribution sync also depends on the setting of Register 0x0405[3].
	4	Mask Channel 0 sync	Masks the synchronous reset to the Channel 0 (M0) divider. 0 (default) = unmasked. The output drivers do not toggle until a SYNC pulse occurs. 1 = masked. Setting this bit asynchronously releases Channel 0 from the static SYNC state, thus allowing the Channel 0 divider to toggle. Channel 0 ignores all SYNC events while this bit is set. Setting this bit does not enable the output drivers connected to this channel. In addition, the output distribution sync also depends on the setting of Register 0x0405[3].
	3	Reserved	Default: 0b.
	2	Sync source selection	Selects the sync source for the clock distribution output channels. 0 (default) = direct. The sync pulse happens on the next I/O update. 1 = active reference. Note that the output distribution sync also depends on the APLL being calibrated and locked unless Register 0x0405[3] = 1b.
	[1:0]	Automatic sync mode	Autosync mode. 00 = disabled. A sync command must be issued manually, or by using the mask sync bits in this register (Bits[7:4]). 01 = sync on DPLL frequency lock. 10 (default) = sync on DPLL phase lock. 11 = reserved.

Table 68. Distribution OUT0 Setting

Address	Bits	Bit Name	Description
0x0501	7	Enable 3.3 V CMOS driver	0 (default) = disables 3.3 V CMOS driver; the OUT5 1.8 V logic is controlled by Register 0x0501[6:4]. 1 = enables 3.3 V CMOS driver as operating mode of OUT0. This bit must be enabled only if Bits[6:4] are in CMOS mode.
	[6:4]	OUT0 format	This control is valid when Register 0x0501[7] = 0. When Register 0x0501[7] = 1, OUT5 is in 3.3 V CMOS mode and these bits are ignored. Select the operating mode of OUT0.
			000 = PD, tristate. 001 (default) = HSTL. 010 = LVDS. 011 = reserved. 100 = CMOS, both outputs active. 101 = CMOS, P output active, N output power-down. 110 = CMOS, N output active, P output power-down. 111 = reserved.
	[3:2]	OUT0 polarity	Control the OUT0 polarity. 00 (default) = positive, negative. 01 = positive, positive. 10 = negative, positive. 11 = negative, negative.
	1	OUT0 drive strength	Controls the output drive capability of OUT0. Note that this is only in 3.3 V CMOS mode for CMOS strength. 1.8 V CMOS has only the low drive strength. 0 (default) = CMOS: low drive strength; LVDS: 3.5 mA nominal. 1 = CMOS: normal drive strength; LVDS: 4.5 mA nominal (LVDS boost mode).
	0	Enable OUT0	Enables/disables (1b/0b) OUT0 1.8 V driver (default is disabled). This bit does not enable/disable OUT0 if Bit 7 of this register is set.

Table 69. Distribution Channel 0 Divider Setting

Address	Bits	Bit Name	Description
0x0502	[7:0]	Channel 0 (M0) division ratio	10-bit channel divider bits[7:0] (LSB). Division equals channel divider, Bits[9:0] + 1. (Bits[9:0] = 0 is divide-by-1, Bits[9:0] = 1 is divide-by-2...Bits[9:0] = 1023 is divide-by-1024)
0x0503	[7:4]	Reserved	Reserved.
	3	Channel 0 PD	0 (default) = normal operation. 1 = powers down Channel 0.
	2	Select RF Divider 2	1 = selects RF Divider 2 as prescaler for Channel 0 divider. 0 (default) = selects RF Divider 1 as prescaler for Channel 0 divider.
	[1:0]	Channel 0 (M0) division ratio	10-bit channel divider, Bits[9:8] (MSB)
0x0504	[7:6]	Reserved	Reserved. Default: 00b
	[5:0]	Channel 0 divider phase	Divider initial phase after sync relative to the divider input clock (from the RF divider output). LSB is $\frac{1}{2}$ of a period of the divider input clock. Default: 00000b. Phase = 0 is no phase offset. Phase = 1 is $\frac{1}{2}$ a period offset.

Table 70. Distribution OUT1 Setting

Address	Bits	Bit Name	Description
0x0505	7	Reserved	Reserved; default: 0b
	[6:4]	OUT1 format	Select the operating mode of OUT1 000 = PD, tristate 001 (default) = HSTL 010 = LVDS 011 = reserved 100 = CMOS, both outputs active 101 = CMOS, P output active, N output power-down 110 = CMOS, N output active, P output power-down 111 = reserved
	[3:2]	OUT1 polarity	Configure the OUT1 polarity in CMOS mode and are active in CMOS mode only 00 (default) = positive, negative 01 = positive, positive 10 = negative, positive 11 = negative, negative
	1	OUT1 drive strength	Controls the output drive capability of OUT1 0 (default) = LVDS: 3.5 mA nominal 1 = LVDS: 4.5 mA nominal (LVDS boost mode) No CMOS control because OUT1 is 1.8 V CMOS only
	0	Enable OUT1	Setting this bit enables the OUT1 driver (default is disabled)
0x0506	7	Reserved	Reserved; default: 0b
	[6:4]	OUT2 format	Select the operating mode of OUT2 000 = PD, tristate 001 (default) = HSTL 010 = LVDS 011 = reserved 100 = CMOS, both outputs active 101 = CMOS, P output active, N output power-down 110 = CMOS, N output active, P output power-down 111 = reserved
	[3:2]	OUT2 polarity	Configure the OUT2 polarity in CMOS mode and are active in CMOS mode only 00 (default) = positive, negative 01 = positive, positive 10 = negative, positive 11 = negative, negative
	1	OUT2 drive strength	Controls the output drive capability of OUT2 0 (default) = LVDS: 3.5 mA nominal 1 = LVDS: 4.5 mA nominal (LVDS boost mode) No CMOS control because OUT2 is 1.8 V CMOS only
	0	Enable OUT2	Setting this bit enables the OUT2 driver (default is disabled)

Table 71. Distribution Channel 1 Divider Setting

Address	Bits	Bit Name	Description
0x0507	[7:0]	Channel 1 divider	The same control for Channel 1 divider as in Register 0x0502 for Channel 0 divider
0x0508	[7:0]	Channel 1 divider	The same control for Channel 1 divider as in Register 0x0503 for Channel 0 divider
0x0509	[7:0]	Channel 1 divider	The same control for Channel 1 divider as in Register 0x0504 for Channel 0 divider

Table 72. Clock Distribution Channel 2 and OUT3, OUT4 Driver Settings

Address	Bits	Bit Name	Description
0x050A	[7:0]	OUT3	The same control for OUT3 as in Register 0x0505 for OUT1
0x050B	[7:0]	OUT4	The same control for OUT4 as in Register 0x0505 for OUT1
0x050C	[7:0]	Channel 2 divider	The same control for Channel 2 divider as in Register 0x0502 for Channel 0 divider
0x050D	[7:0]	Channel 2 divider	The same control for Channel 2 divider as in Register 0x0503 for Channel 0 divider
0x050E	[7:0]	Channel 2 divider	The same control for Channel 2 divider as in Register 0x0504 for Channel 0 divider

Table 73. Clock Distribution Channel 3 and OUT5 Driver Settings

Address	Bits	Bit Name	Description
0x050F	7	Enable 3.3 V CMOS driver	0 (default) = disable 3.3 V CMOS driver; the OUT5 1.8 V logic is controlled by Register 0x050F[6:4]. This bit must be enabled only if Bits[6:4] are in CMOS mode. 1 = enable 3.3 V CMOS driver as operating mode of OUT5.
	[6:4]	OUT5 format	This control is valid when Register 0x050F[7] = 0; when Register 0x050F[7] = 1, OUT5 is in 3.3 V CMOS mode and these bits are ignored. Select the operating mode of OUT5. 000 = PD, tristate. 001 (default) = HSTL. 010 = LVDS. 011 = reserved. 100 = CMOS, both outputs active. 101 = CMOS, P output active, N output power-down. 110 = CMOS, N output active, P output power-down. 111 = reserved.
	[3:2]	OUT5 polarity	Control the OUT5 polarity. 00 (default) = positive, negative. 01 = positive, positive. 10 = negative, positive. 11 = negative, negative.
	1	OUT5 drive strength	Controls the output drive capability of OUT5. Note that this is only in 3.3 V CMOS mode for CMOS strength. 1.8 V CMOS has only the low drive strength. 0 (default) = CMOS: low drive strength, LVDS: 3.5 mA nominal. 1 = CMOS: normal drive strength, LVDS: 4.5 mA nominal (LVDS boost mode).
	0	OUT5 enable	Enables/disables (1b/0b) OUT5 1.8 V driver (default is disabled). This bit does not enable/disable OUT5 if Bit 7 of this register is set.
0x0510	[7:0]	Channel 3, Divider 1 (M3) division ratio	10-bit channel divider, Bits[7:0] (LSB) (default: 0x03). Division equals channel divider, Bits[9:0] + 1. (Bits[9:0] = 0 is divide-by-1, Bits[9:0] = 1 is divide-by-2...Bits[9:0] = 1023 is divide-by-1024).
0x0511	[7:2]	Reserved	Reserved.
	[1:0]	Channel 3, Divider 1 (M3) division ratio	10-bit channel divider, Bits[9:8] (MSB) (default: 0x00).
0x0512	[7:0]	Channel 3, Divider 2 (M3b) division ratio	10-bit channel divider, Bits[7:0] (LSB). Division equals channel divider bits[9:0] + 1. (Bits[9:0] = 0 is divide-by-1, Bits[9:0] = 1 is divide-by-2...Bits[9:0] = 1023 is divide-by-1024).
0x0513	[7:4]	Reserved	Reserved.
	4	Channel 3 doubler	0 (default) = normal operation. 1 = enables Channel 3 clock doubler. This bit activates an internal clock doubler that doubles the frequency of the Channel 3 divider. In this mode, Channel 3, Divider 2 is bypassed.
	3	PD Channel 3	0 (default) = normal operation. 1 = powers down Channel 3.
	2	Select RF divider for Channel 2	1 = selects RF Divider 2 as prescaler for the Channel 3 divider. 0 (default) = selects RF Divider 1 as a prescaler for the Channel 3 divider.
	[1:0]	Channel 3, Divider 2 (M3b) division ratio	10-bit channel divider, Bits[9:8] (MSB).
0x0514	[7:0]	Channel 3, Divider 1 (M3) phase	The same control for Channel 3, Divider 1 phase as found in Register 0x0504 for Channel 0 divider phase (default: 0x00).
0x0515	[7:0]	Channel 3, Divider 2 (M3b) phase	The same control for Channel 3, Divider 2 phase as found in Register 0x0504 for Channel 0 divider phase (default: 0x00).

REFERENCE INPUTS (REGISTER 0x0500 TO REGISTER 0x0507)**Table 74. Reference Power-Down¹**

Address	Bits	Bit Name	Description
0x0600	[7:4]	Reserved	Default: 0x0
	3	REFD power-down	Power down REFD input receiver (default: not powered down).
	2	REFC power-down	Power down REFC input receiver (default: not powered down).
	1	REFB power-down	Power down REFB input receiver (default: not powered down).
	0	REFA power-down	Power down REFA input receiver (default: not powered down).

¹ When all bits are set the reference receiver section enters a deep sleep mode.

Table 75. Reference Logic Family

Address	Bits	Bit Name	Description
0x0601	[7:6]	REFD logic family	Select logic family for REFD input receiver; only REFD_P is used in CMOS mode 00 (default) = differential 01 = 1.2 V to 1.5 V CMOS 10 = 1.8 V to 2.5 V CMOS 11 = 3.0 V to 3.3 V CMOS
	[5:4]	REFC logic family	Same as Register 0x0601 [7:6] for REFC
	[3:2]	REFB logic family	Same as Register 0x0601 [7:6] for REFB
	[1:0]	REFA logic family	Same as Register 0x0601 [7:6] for REFA

Table 76. Reference Priority Setting

Address	Bits	Bit Name	Description
0x0602	[7:6]	REFD priority family	User-assigned priority level (0 to 3) of the reference associated with REFB, which ranks that reference relative to the others. 00 (default) = 0. 01 = 1. 10 = 2. 11 = 3.
	[5:4]	REFC priority family	Same as Register 0x0602 [7:6] for REFC.
	[3:2]	REFB priority family	Same as Register 0x0602 [7:6] for REFB.
	[1:0]	REFA priority family	Same as Register 0x0602 [7:6] for REFA.

FRAME SYNCHRONIZATION (REGISTER 0x0640 TO REGISTER 0x0641)

Table 77. Frame Sync Setting

Address	Bit(s)	Bit Name	Description
0x0640	[7:1]	Reserved	Reserved; default: 0x00.
	0	Enable FSYNC	Enable frame synchronization. 0 (default) = frame synchronization disabled. 1 = frame synchronization enabled.
0x0641	[7:4]	Reserved	Reserved; default: 0x00.
	3	Validate FSYNC reference	Setting this bit forces the reference validation logic to declare REFA valid only if the REFB (the sync pulse) input is also valid. This bit can be thought as a logical AND of REFA VALID and REFB VALID signals. If REFC is selected, this bit requires that REFD (the sync pulse) input also be valid before declaring REFC valid. 0 (default) = only the selected reference input must be valid. 1 = the sync pulse input must also be valid to validate the selected input.
	2	FSYNC one shot	Selects one-shot or level-sensitive frame sync function. 0 (default) = use level-sensitive frame sync. Frame sync occurs on every edge of the frame pulse. 1 = use one-shot frame sync. Frame sync occurs <u>only on the first</u> frame sync pulse (on REFB or REFD). User must re-arm by raising the SYNC pin high and then low, or by clearing and resetting the arm soft FSYNC bit. As with all buffered registers, an I/O update is required (Register 0x0005[0] = 0x01) after writing this register.
	1	FSYNC arm method	Selects which <u>signal</u> is used to arm the frame sync 0 (default) = use SYNC pin. 1 = use arm soft FSYNC (Register 0x0641[0]).
	0	Arm soft FSYNC	Arms frame sync after I/O update. Next pulse on REFB or REFD is the sync pulse. The FSYNC arm method bit must also be set for this bit to take effect. 0 = (default); frame sync unarmed. 1 = frame sync armed.

DPLL PROFILE REGISTERS (REGISTER 0x0700 TO REGISTER 0x07E6)

Note that the default values of the REFA and REFC profiles are as follows: input frequency=19.44 MHz, output frequency = 622.08 MHz/155.52 MHz, loop bandwidth = 400 Hz, normal phase margin, inner tolerance = 5%, and outer tolerance = 10%.

The default values of the REFB and REFD profiles are as follows: input frequency = 8 kHz, output frequency = 622.08 MHz/155.52 MHz, loop bandwidth = 100 Hz, normal phase margin, inner tolerance = 5%, and outer tolerance = 10%.

REFA Profile (Register 0x0700 to Register 0x0726)**Table 78. Reference Period—REFA Profile**

Address	Bits	Bit Name	Description
0x0700	[7:0]	Nominal reference period (fs)	Nominal reference period bits[7:0] (default: 0xC9).
0x0701	[7:0]		Nominal reference period bits[15:8] (default: 0xEA).
0x0702	[7:0]		Nominal reference period bits[23:16] (default: 0x10).
0x0703	[7:0]		Nominal reference period bits[31:24] (default: 0x03).
0x0704	[7:0]		Nominal reference period bits[39:32] (default: 0x00). Default for Register 0x0700 to Register 0x0704 = 0x000310EAC9 = 51.44 ns (1/19.44 MHz).

Table 79. Reference Period Tolerance—REFA Profile

Address	Bits	Bit Name	Description
0x0705	[7:0]	Inner tolerance	Input reference frequency monitor inner tolerance, Bits[7:0] (default: 0x14).
0x0706	[7:0]		Input reference frequency monitor inner tolerance, Bits[15:8] (default: 0x00).
0x0707	[7:4]	Reserved	Default: 0x0.
	[3:0]	Inner tolerance	Input reference frequency monitor inner tolerance, Bits[19:16]. Default for Register 0x0705 to Register 0x707 = 0x000014 = 20 (5% or 50,000 ppm). The Stratum 3 clock requires inner tolerance of ± 9.2 ppm and outer tolerance of ± 12 ppm; an SMC clock requires an outer tolerance of ± 48 ppm. The allowable range for the inner tolerance is 0x00A (10%) to 0x8FF (1 ppm). The tolerance of the input frequency monitor is only as accurate as the system clock frequency.
0x0708	[7:0]	Outer tolerance	Input reference frequency monitor outer tolerance, Bits[7:0] (default: 0x0A).
0x0709	[7:0]		Input reference frequency monitor outer tolerance, Bits[15:8] (default: 0x00).
0x070A	[7:4]	Reserved	Reserved.
	[3:0]	Outer tolerance	Input reference frequency monitor outer tolerance, Bits[19:16]. Default for Register 0x0708 to Register 0x70A = 0x00000A = 10 (10% or 100,000 ppm). The Stratum 3 clock requires an inner tolerance of ± 9.2 ppm and outer tolerance of ± 12 ppm; an SMC clock requires outer tolerance of ± 48 ppm. The outer tolerance register setting must always be smaller than the inner tolerance.

Table 80. Reference Validation Timer—REFA Profile

Address	Bits	Bit Name	Description
0x070B	[7:0]	Validation timer (ms)	Validation timer, Bits[7:0] (default: 0x0A). This is the amount of time a reference input must be valid before it is declared valid by the reference input monitor (default: 10 ms).
0x070C	[7:0]		Validation timer, Bits[15:8] (default: 0x00).

Table 81. Reserved Register

Address	Bits	Bit Name	Description
0x070D	[7:0]	Reserved	Reserved. Default: 0x00.

Table 82. DPLL Base Loop Filter Selection—REFA Profile

Address	Bits	Bit Name	Description
0x070E	[7:1]	Reserved	Reserved. Default: 0x00.
	0	Select high PM base loop filter	0 = base loop filter with normal (70°) phase margin (default). 1 = base loop filter with high (88.5°) phase margin. (≤ 0.1 dB peaking in the closed-loop transfer function for loop BWs ≤ 2 kHz. Setting this bit is also recommended for loop BW > 2 kHz.)

Table 83. DPLL Loop BW Scaling Factor—REFA Profile¹

Address	Bits	Bit Name	Description
0x070F	[7:0]	DPLL loop BW scaling factor (unit of 0.1 Hz)	Digital PLL loop bandwidth scaling factor, Bits[7:0] (default: 0xF4).
0x0710	[7:0]		Digital PLL loop bandwidth scaling factor, Bits[15:8] (default: 0x01). The default for Register 0x070F to Register 0x0710 = 0x01F4 = 500 (50 Hz loop bandwidth). The loop bandwidth must always be less than the DPLL phase detector frequency divided by 20.
0x0711	[7:1]	Reserved	Default: 0x00.
	0	BW scaling factor	Digital PLL loop bandwidth scaling factor, Bit 16 (default: 0b).

¹Note that the default DPLL loop BW is 50.4 Hz.

Table 84. R-Divider—REFA Profile1

Address	Bits	Bit Name	Description
0x0712	[7:0]	R divider	DPLL integer reference divider (minus 1), Bits[7:0] (default: 0xC5)
0x0713	[7:0]		DPLL integer reference divider, Bits[15:8] (default: 0x00)
0x0714	[7:5]	Reserved	Reserved. Default: 0x0
	4	Enable REFA div2	Enables the reference input divide-by-2 for REFA 0 = bypass the divide-by-2 (default) 1 = enable the divide-by-2
	[3:0]	R divider	DPLL integer reference divider, Bits[19:16] (default: 0x0). The default for Register 0x0712 to Register 0x0714 = 0x00C5 = 197 (which equals R = 198).

¹Note that the value stored in the R-divider register yields an actual divide ratio of one more than the programmed value.

Table 85. Integer Part of Fractional Feedback Divider N1—REFA Profile1

Address	Bits	Bit Name	Description
0x0715	[7:0]	Integer Part N1	DPLL integer feedback divider (minus 1), Bits[7:0] (default: 0x6B).
0x0716	[7:0]		DPLL integer feedback divider, Bits[15:8] (default: 0x07).
0x0717	[7:1]	Reserved	Reserved. Default: 0x00.
	0	Integer Part N1	DPLL integer feedback divider, Bit 16 (default: 0b). The default for Register 0x0715 to Register 0x717 = 0x0076B (which equals N1 = 1900).

¹Note that the value stored in the N1-divider register yields an actual divide ratio of one more than the programmed value.

Table 86. Fractional Part of Fractional Feedback Divider FRAC1—REFA Profile

Address	Bits	Bit Name	Description
0x0718	[7:0]	Digital PLL fractional feedback divider—FRAC1	The numerator of the fractional-N feedback divider, Bits[7:0] (default: 0x04)
0x0719	[7:0]		The numerator of the fractional-N feedback divider, Bits[15:8] (default: 0x00)
0x071A	7	Reserved	Reserved. Default: 0b.
	[6:0]	Digital PLL fractional feedback divider—FRAC1	The numerator of the fractional-N feedback divider, Bits[22:16] (default: 0x00)

Table 87. Modulus of Fractional Feedback Divider MOD1—REFA Profile

Address	Bits	Bit Name	Description
0x071B	[7:0]	Digital PLL feedback divider modulus—MOD1	The denominator of the fractional-N feedback divider, Bits[7:0] (default: 0x05)
0x071C	[7:0]		The denominator of the fractional-N feedback divider, Bits[15:8] (default: 0x00)
0x071D	7	Reserved	Reserved. Default: 0b.
	[6:0]	Digital PLL feedback divider modulus—MOD1	The denominator of the fractional-N feedback divider, Bits[22:16] (default: 0x00)

Table 88. Phase and Frequency Lock Detector Controls—REFA Profile

Address	Bits	Bit Name	Description
0x071E	[7:0]	Phase lock threshold	Phase lock threshold, Bits[7:0] (default: 0xBC); default of 0x02BC = 700 ps
0x071F	[7:0]		Phase lock threshold, Bits[15:8] (default: 0x02)
0x0720	[7:0]	Phase lock fill rate	Phase lock fill rate, Bits[7:0] (default: 0x0A = 10 code/PFD cycle)
0x0721	[7:0]	Phase lock drain rate	Phase lock drain rate, Bits[7:0] (default: 0x0A = 10 code/PFD cycle)
0x0722	[7:0]	Frequency lock threshold	Frequency lock threshold, Bits[7:0] (default: 0xBC); default of 0x02BC = 700 ps
0x0723	[7:0]		Frequency lock threshold, Bits[15:8] (default: 0x02)
0x0724	[7:0]		Frequency lock threshold, Bits[23:16] (default: 0x00)
0x0725	[7:0]	Frequency lock fill rate	Frequency lock fill rate, Bits[7:0] (default: 0x0A = 10 code/PFD cycle)
0x0726	[7:0]	Frequency lock drain rate	Frequency lock drain rate bits[7:0] (default: 0x0A = 10 code/PFD cycle)

REFB Profile (Register 0x0740 to Register 0x0766)

REFB Profile Register 0x0740 to Register 0x0766 are identical to REFA Profile Register 0x0700 to Register 0x0726.

REFC Profile (Register 0x0780 to Register 0x07A6)

REFC Profile Register 0x0780 to Register 0x07A6 are identical to REFA Profile Register 0x0700 Register 0x0726.

REFD Profile (Register 0x07C0 to Register 0x07E6)

REFD Profile Register 0x07C0 to Register 0x07E6 are identical to REFA Profile Register 0x0700 to Register 0x0726.

OPERATIONAL CONTROLS (REGISTER 0x0A00 TO REGISTER 0x0A10)

Table 89. General Power-Down

Address	Bits	Bit Name	Description
0x0A00	7	Soft reset exclude register map	Resets device but retains programmed register values (default: not reset)
	6	DCO power-down	Places DCO in deep sleep mode (default: not powered down)
	5	SYSCLK power-down	Places SYSCLK input and PLL in deep sleep mode (default: not powered down)
	5	Reference input power-down	Places reference clock inputs in deep sleep mode (default: not powered down)
	3	TDC power-down	Places the time-to-digital converter in deep sleep mode (default: not powered down)
	2	APLL power-down	Places the output PLL in deep sleep mode (default: not powered down)
	1	Clock distribution power-down	Places the clock distribution outputs in deep sleep mode (default: not powered down)
	0	Full power-down	Places the entire device in deep sleep mode (default: not powered down)

Table 90. Loop Mode

Address	Bits	Bit Name	Description
0x0A01	7	Reserved	Reserved.
	6	User holdover	Forces the device into holdover mode (default: not forced holdover mode). If a tuning word history is available, then the history tuning word specifies the DCO output frequency. Otherwise, the free run frequency tuning word register specifies the DCO output frequency. The phase and frequency lock detectors are forced into the unlocked state.
	5	User free run	Forces the device into user free run mode (default is not forced user free run mode). The free run frequency tuning word register specifies the DCO output frequency. When the user free run bit is set, it overrides the user holdover bit (Address 0x0A01, Bit 6).
	[4:2]	REF switchover mode	Selects the operating mode of the reference switching state machine.
		Reference Switchover Mode, Bits[2:0] Register 0x0A01[4:2]	Reference Selection Mode
		000 (default)	Automatic revertive mode
		001	Automatic nonrevertive mode
		010	Manual reference select (with automatic fallback mode)
		011	Manual reference select mode (with auto-holdover)
		100	Full manual mode (no auto-holdover)
		101	Not used
		110	Not used
		111	Not used

Address	Bits	Bit Name	Description
	[1:0]	User reference in manual switchover mode	Input reference when REF switchover mode bits (Register 0x0A01, Bits[4:2]) = 010, 011, or 100. 00 (default) = Input Reference A. 01 = Input Reference B. 10 = Input Reference C. 11 = Input Reference D.

Table 91. Cal/Sync Distribution

Address	Bits	Bit Name	Description
0x0A02	[7:2]	Reserved	Default: 0x00
	1	Soft sync clock distribution	Setting this bit initiates synchronization of the clock distribution output (default: 0b). Nonmasked outputs stall when value is 1b; restart is initialized on 1b to 0b transition.
	0	Reserved	Default: 0b.

Reset Functions (Register 0x0A03)Table 92. Reset Functions¹

Address	Bits	Bit Name	Description
0x0A03 (autoclear)	7	Reserved	Default: 0b.
	6	Clear LF	Setting this bit clears the digital loop filter (intended as a debug tool).
	5	Clear CCI	Setting this bit clears the CCI filter (intended as a debug tool).
	4	Reserved	Default: 0b.
	3	Clear auto sync	Setting this bit resets the automatic synchronization logic (see Register 0x0500).
	2	Clear TW history	Setting this bit resets the tuning word history logic (part of holdover functionality).
	1	Clear all IRQs	Setting this bit clears the entire IRQ monitor register (Register 0x0D02 to Register 0x0D07). It is the equivalent of setting all the bits of the IRQ clearing register (Register 0x0A04 to Register 0x0A0D).
	0	Clear watchdog timer	Setting this bit resets the watchdog timer (see Register 0x0211 and Register 0x0212). If the timer times out, it starts a new timing cycle. If the timer has not yet timed out, it restarts at time zero without causing a timeout event. Continuously resetting the watchdog timer at intervals less than its timeout period prevents the watchdog timer from generating a timeout event.

¹Note that all bits in this register are autoclearing.

IRQ Clearing (Register 0x0A04 to Register 0x0A09)

The IRQ clearing registers are identical in format to the IRQ monitor registers (Register 0x0D02 to Register 0x0D09). When set to logic 1, an IRQ clearing bit resets the corresponding IRQ monitor bit, thereby canceling the interrupt request for the indicated event. The IRQ clearing register is an autoclearing register.

Table 93. IRQ Clearing for SYSCLK

Address	Bits	Bit Name	Description
0x0A04	[7:6]	Reserved	Reserved
	5	SYSCLK unlocked	Clears SYSCLK unlocked IRQ
	4	SYSCLK locked	Clears SYSCLK locked IRQ
	3	APLL unlocked	Clears Output PLL unlocked IRQ
	2	APLL locked	Clears Output PLL locked IRQ
	1	APLL calibration ended	Clears APLL calibration complete IRQ
	0	APLL calibration started	Clears APLL calibration started IRQ

Table 94. IRQ Clearing for Distribution Sync, Watchdog Timer, and EEPROM

Address	Bits	Bit Name	Description
0x0A05	[7:5]	Reserved	Reserved
	4	Pin program end	Clears pin program end IRQ
	3	Sync clock distribution	Clears distribution sync IRQ
	2	Watchdog timer	Clears watchdog timer IRQ
	1	EEPROM fault	Clears EEPROM fault IRQ
	0	EEPROM complete	Clears EEPROM complete IRQ

Table 95. IRQ Clearing for the Digital PLL

Address	Bits	Bit Name	Description
0x0A06	7	Switching	Clears switching IRQ
	6	Closed	Clears closed IRQ
	5	Free run	Clears free run IRQ
	4	Holdover	Clears holdover IRQ
	3	Frequency unlocked	Clears frequency unlocked IRQ
	2	Frequency locked	Clears frequency locked IRQ
	1	Phase unlocked	Clears phase unlocked IRQ
	0	Phase locked	Clears phase locked IRQ

Table 96. IRQ Clearing for History Update, Frequency Limit, and Phase Slew Limit

Address	Bits	Bit Name	Description
0x0A07	[7:5]	Reserved	Reserved
	4	History updated	Clears history updated IRQ
	3	Frequency unclamped	Clears frequency unclamped IRQ
	2	Frequency clamped	Clears frequency clamped IRQ
	1	Phase slew unlimited	Clears phase slew unlimited IRQ
	0	Phase slew limited	Clears phase slew limited IRQ

Table 97. IRQ Clearing for Reference Inputs

Address	Bits	Bit Name	Description
0x0A08	7	Reserved	Reserved
	6	REFB validated	Clears REFB validated IRQ
	5	REFB fault cleared	Clears REFB fault cleared IRQ
	4	REFB fault	Clears REFB fault IRQ
	3	Reserved	Reserved
	2	REFA validated	Clears REFA validated IRQ
	1	REFA fault cleared	Clears REFA fault cleared IRQ
	0	REFA fault	Clears REFA fault IRQ
0x0A09	7	Reserved	Reserved
	6	REFD validated	Clears REFD validated IRQ
	5	REFD fault cleared	Clears REFD fault cleared IRQ
	4	REFD fault	Clears REFD fault IRQ
	3	Reserved	Reserved
	2	REFC validated	Clears REFC validated IRQ
	1	REFC fault cleared	Clears REFC fault cleared IRQ
	0	REFC fault	Clears REFC fault IRQ

Table 98. Incremental Phase Offset Control

Address	Bits	Bit Name	Description
0x0A0A	[7:3]	Reserved	Reserved.
	2	Reset phase offset	Resets the incremental phase offset to zero. This is an autoclearing bit.
	1	Decrement phase offset	Decrements the incremental phase offset by the amount specified in the incremental phase lock offset step size registers (Register 0x0312 to Register 0x0313). This is an autoclearing bit.
	0	Increment phase offset	Increments the incremental phase offset by the amount specified in the incremental phase lock offset step size registers (Register 0x0312 to Register 0x0313). This is an autoclearing bit.

Table 99. Reference Validation Override Controls

Address	Bits	Bit Name	Description
0x0A0B	[7:4]	Reserved	Reserved.
	3	Force Timeout D	Setting this autoclearing bit emulates timeout of the validation timer for Reference D and allows the user to make REFD valid immediately.
	2	Force Timeout C	Setting this autoclearing bit emulates timeout of the validation timer for Reference C and allows the user to make REFC valid immediately.
	1	Force Timeout B	Setting this autoclearing bit emulates timeout of the validation timer for Reference B and allows the user to make REFB valid immediately.
	0	Force Timeout A	Setting this autoclearing bit emulates timeout of the validation timer for Reference A and allows the user to make REFA valid immediately.
0x0A0C	[7:4]	Reserved	Reserved.
	3	Ref Mon Override D	Overrides the reference monitor REF FAULT signal for Reference D (default: 0).
	2	Ref Mon Override C	Overrides the reference monitor REF FAULT signal for Reference C (default: 0).
	1	Ref Mon Override B	Overrides the reference monitor REF FAULT signal for Reference B (default: 0).
	0	Ref Mon Override A	Overrides the reference monitor REF FAULT signal for Reference A (default: 0).
0x0A0D	[7:4]	Reserved	Reserved.
	3	Ref Mon Bypass D	Bypasses the reference monitor for Reference D (default: 0).
	2	Ref Mon Bypass C	Bypasses the reference monitor for Reference C (default: 0).
	1	Ref Mon Bypass B	Bypasses the reference monitor for Reference B (default: 0).
	0	Ref Mon Bypass A	Bypasses the reference monitor for Reference A (default: 0).

QUICK IN/OUT FREQUENCY SOFT PIN CONFIGURATION (REGISTER 0x0C00 TO REGISTER 0x0C08)

Table 100. Soft Pin Program Setting¹

Address	Bits	Bit Name	Description			
0x0C00	[7:1]	Reserved	Reserved.			
	0	Enable Soft Pin Section 1	0 (default) = disables the function of soft pin registers in Soft Pin Section 1 (Register 0x0C01 and Register 0x0C02). 1 = enables the function of soft pin registers in Soft Pin Section 1 (Register 0x0C01 to Register 0x0C02) when the PINCONTROL pin is low at startup and/or reset. The register in Soft Pin Section 1 configures the device into one of 256 preconfigured input-to-output frequency translations stored in the on-chip ROM. The registers in Soft Pin Section 1 (Register 0x0C00 to Register 0x0C02) are ignored when the PINCONTROL pin is high at power-up and/or reset (which means the hard pin program is enabled).			
0x0C01	[7:4]	Output frequency selection	Selects one of 16 predefined output frequencies as output frequency of the desired frequency translation and reprograms the free run TW, N2, RF divider, and M0 to M3b dividers with the value stored in the ROM.			
	[3:0]	Input frequency selection	Selects one of 16 predefined input frequencies as the input frequency of the desired frequency translation and reprograms the reference period, R divider, N1, FRAC1, and MOD1 in four REF profiles with the value stored in the ROM.			
0x0C02	[7:2]	Reserved	Reserved.			
	[1:0]	System clock PLL ref selection	Selects one of the four predefined system PLL references for the desired frequency translation and reprograms the system PLL configuration with the value stored in the ROM. To load values from the ROM, the user must write Register 0x0C07[0] = 1 after writing this.			
			Register 0x0C02[1:0]		Equivalent System Clock PLL Settings, Register 0x0100 to Register 0x101[3:0]	
			System PLL Ref	Bit 1	Bit 0	12 Bits
			1	0	0	24.576 MHz XTAL, x2 on, N = 8
2	0	1	49.152 MHz XTAL, x2 on, N = 8			
3	1	0	24.576 MHz XO, x2 off, N = 16			
4	1	1	49.152 MHz XO, x2 off, N = 8			

Address	Bits	Bit Name	Description
0x0C03	[7:1]	Reserved	Reserved.
	0	Enable Soft Pin Section 2	0 (default) = disables the function of soft pin registers in Soft Pin Section 2 (Register 0x0C04 to Register 0x0C06). 1 = enables the function of soft pin registers in Soft Pin Section 2 (Register 0x0C04 to Register 0x0C06) when PINCONTROL pin is low.
0x0C04	[7:4]	Reserved	Reserved.
	[3:2]	REFB frequency scale	Scales the the selected input frequency (defined by Register 0x0C01[3:0]) for REFB. For example, if the selected input frequency is 622.08 MHz and Register 0x0C04[3:2] = 11, the new input frequency is 622.08 MHz/16 = 38.8 MHz. 00 (default) = divide-by-1. 01 = divide-by-4. 10 = divide-by-8. 11 = divide-by-16.
	[1:0]	REFA frequency scale	Scales the the selected input frequency (defined by Register 0x0C01[3:0]) for REFA. 00 (default) = divide-by-1. 01 = divide-by-4. 10 = divide-by-8. 11 = divide-by-16.
0x0C05	[7:4]	Reserved	Reserved.
	[3:2]	Channel 1 output frequency scale	Scales the selected output frequency (defined by Register 0x0C01[7:4]) for the Channel Divider 1 output. 00 (default) = divide-by-1. 01 = divide-by-4. 10 = divide-by-8. 11 = divide-by-16.
	[1:0]	Channel 0 output frequency scale	Scale the selected output frequency (defined by Register 0x0C01[7:4]) for the Channel Divider 0 output. 00 (default) = divide-by-1. 01 = divide-by-4. 10 = divide-by-8. 11 = divide-by-16.
0x0C06	[7:5]	Reserved	Reserved.
	4	Select high PM base loop filter	0 = base loop filter with normal (70°) phase margin (default). 1 = base loop filter with high (88.5°) phase margin. (< 0.1 dB peaking in closed-loop transfer function).
	[3:2]	DPLL loop BW	Scale the DPLL loop BW while in soft pin mode. 00 (default) = 50 Hz. 01 = 1 Hz. 10 = 10 Hz. 11 = 100 Hz.
	[1:0]	Reference input frequency tolerance	Scales the input frequency tolerance while in soft pin mode. 00 (default) = outer tolerance: 10%; inner tolerance: 8% (for general conditions). 01 = outer tolerance: 12 ppm; inner tolerance: 9.6 ppm (for Stratum 3). 10 = outer tolerance: 48 ppm; inner tolerance: 38 ppm (for SMC clock standard). 11 = outer tolerance: 200 ppm; inner tolerance: 160 ppm (for XTAL system clock).
0x0C07	[7:1]	Reserved	Reserved.
	0	Soft pin start transfer	Autoclearing register. 1 = initiates ROM download without resetting the device/register map. After ROM download is complete, this register is reset.
0x0C08	[7:1]	Reserved	Reserved.
	0	Soft pin reset	Autoclearing register; resets the device like soft reset (Register 0x0000[5]), except that this reset function initiates a soft pin ROM download without resetting the device/register map. After ROM download is complete, this register is pulled back to zero.

¹ All bits in Register 0x0C00 to Register 0x0C06 take effect only with either a soft pin start transfer (Register 0x0C07) or soft pin reset (Register 0x0C08).

STATUS READBACK (REGISTER 0x0D00 TO REGISTER 0x0D14)

All bits in Register 0x0D00 to Register 0x0D14 are read only. To show the latest status, Register 0x0D08 through Register 0x0D14 require an I/O update (Register 0x0005 = 0x01) immediately before being read. However, Register 0x0D00 through Register 0x0D07 are live.

Table 101. EEPROM Status

Address	Bits	Bit Name	Description
0x0D00	[7:4]	Reserved	Reserved.
	3	Pin program ROM load process	The control logic sets this bit when data is being read from the ROM.
	2	Fault detected	An error occurred while saving data to or loading data from the EEPROM.
	1	Load in progress	The control logic sets this bit while data is being read from the EEPROM.
	0	Save in progress	The control logic sets this bit while data is being written to the EEPROM.

Table 102. SYSCLK Status

Address	Bits	Bit Name	Description
0x0D01	7	Raw SYSCLK lock detect	Indicates the status of the system clock PLL (not latched by SYSCLK gating circuit). 0 = system clock PLL is unlocked. 1 = system clock PLL is locked.
	6	DPLL_APLL_LOCK	Indicates the status of the DPLL and APLL. 0 = either the DPLL or the APLL is unlocked. 1 = both the DPLL and APLL are locked.
	5	All PLLs locked	Indicates the status of the system clock PLL, APLL, and DPLL. 0 = system clock PLL or APLL or DPLL is unlocked. 1 = all three PLLs (system clock PLL, APLL, and DPLL) are locked.
	4	APLL VCO status	1 = OK. 0 = off/clocks are missing.
	3	APLL calibration in process	The control logic holds this bit set while the amplitude calibration of the APLL VCO is in progress.
	2	APLL lock	Indicates the status of the APLL. 0 = APLL unlocked. 1 = APLL locked.
	1	System clock stable	The control logic sets this bit when the device considers the system clock to be stable (see the System Clock Stability Timer section). 0 = not stable (the system clock stability timer has not expired yet). 1 = stable (the system clock stability timer has expired).
	0	SYSCLK lock detect	Indicates the status of the system clock PLL (latched by SYSCLK gating circuit). 0 = system clock PLL is unlocked. 1 = system clock PLL is locked.

IRQ Monitor (Register 0x0D02 to Register 0x0D09)

If not masked via the IRQ mask registers (Register 0x0209 to Register 0x020F), the appropriate IRQ monitor bit is set to a Logic 1 when the indicated event occurs. These bits can be cleared only via the IRQ clearing registers (Register 0x0A04 to Register 0x0A09), the reset all IRQs bit (Register 0x0A03[1]), or a device reset.

Table 103. IRQ Monitor for SYSCLK

Address	Bits	Bit Name	Description
0x0D02	[7:6]	Reserved	Reserved
	5	SYSCLK unlocked	Indicates a SYSCLK PLL state transition from locked to unlocked
	4	SYSCLK locked	Indicates a SYSCLK PLL state transition from unlocked to locked
	3	APLL unlocked	Indicates an output PLL state transition from locked to unlocked
	2	APLL locked	Indicates an output PLL state transition from unlocked to locked
	1	APLL calibration ended	Indicates that APLL calibration is complete
	0	APLL calibration started	Indicates that APLL in APLL calibration has begun

Table 104. IRQ Monitor for Distribution Sync, Watchdog Timer, and EEPROM

Address	Bit	Bit Name	Description
0x0D03	[7:5]	Reserved	Reserved
	4	Pin program end	Indicates successful completion of a ROM load operation
	3	Output distribution sync	Indicates a distribution sync event
	2	Watchdog timer	Indicates expiration of the watchdog timer
	1	EEPROM fault	Indicates a fault during an EEPROM load or save operation
	0	EEPROM complete	Indicates successful completion of an EEPROM load or save operation

Table 105. IRQ Monitor for the Digital PLL

Address	Bits	Bit Name	Description
0x0D04	7	Switching	Indicates that the DPLL is switching to a new reference
	6	Closed	Indicates that the DPLL has entered closed-loop operation
	5	Free run	Indicates that the DPLL has entered free run mode
	4	Holdover	Indicates that the DPLL has entered holdover mode
	3	Frequency unlocked	Indicates that the DPLL has lost frequency lock
	2	Frequency locked	Indicates that the DPLL has acquired frequency lock
	1	Phase unlocked	Indicates that the DPLL has lost phase lock
	0	Phase locked	Indicates that the DPLL has acquired phase lock

Table 106. IRQ Monitor for History Update, Frequency Limit, and Phase Slew Limit

Address	Bits	Bit Name	Description
0x0D05	[7:5]	Reserved	Reserved
	4	History updated	Indicates the occurrence of a tuning word history update
	3	Frequency unclamped	Indicates a frequency limiter state transition from clamped to unclamped
	2	Frequency clamped	Indicates a frequency limiter state transition from unclamped to clamped
	1	Phase slew unlimited	Indicates a phase slew limiter state transition from slew limiting to not slew limiting
	0	Phase slew limited	Indicates a phase slew limiter state transition from not slew limiting to slew limiting

Table 107. IRQ Monitor for Reference Inputs

Address	Bits	Bit Name	Description
0x0D06	7	Reserved	Reserved
	6	REFB validated	Indicates that REFB has been validated
	5	REFB fault cleared	Indicates that REFB has been cleared of a previous fault
	4	REFB fault	Indicates that REFB has been faulted
	3	Reserved	Reserved
	2	REFA validated	Indicates that REFA has been validated
	1	REFA fault cleared	Indicates that REFA has been cleared of a previous fault
	0	REFA fault	Indicates that REFA has been faulted
0x0D07	7	Reserved	Reserved
	6	REFD validated	Indicates that REFD has been validated
	5	REFD fault cleared	Indicates that REFD has been cleared of a previous fault
	4	REFD fault	Indicates that REFD has been faulted
	3	Reserved	Reserved
	2	REFC validated	Indicates that REFC has been validated
	1	REFC fault cleared	Indicates that REFC has been cleared of a previous fault
	0	REFC fault	Indicates that REFC has been faulted

DPLL Status, Input Reference Status, Holdover History, and DPLL Lock Detect Tub Levels (Register 0x0D08 to Register 0x0D14)**Table 108. DPLL Status¹**

Address	Bits	Bit Name	Description
0x0D08	7	Reserved	Reserved
	6	Offset slew limiting	The current closed-loop phase offset is rate limited
	5	Frequency lock	The DPLL has achieved frequency lock
	4	Phase lock	The DPLL has achieved phase lock
	3	Loop switching	The DPLL is in the process of a reference switchover
	2	Holdover	The DPLL is in holdover mode
	1	Active	The DPLL is active (that is, operating in a closed-loop condition)
	0	Free run	The DPLL is free run (that is, operating in an open-loop condition)
0x0D09	[7:6]	Reserved	Default: 0b
	5	Frequency clamped	The upper or lower frequency tuning word clamp is in effect
	4	History available	There is sufficient tuning word history available for holdover operation
	[3:2]	Active reference priority	Priority value of the currently active reference 00 = highest priority ... 11 = lowest priority
	[1:0]	Current active reference	Index of the currently active reference 00 = Reference A 01 = Reference B 10 = Reference C 11 = Reference D

¹Note that the user must issue an I/O update by writing 0x01 to Register 0x0005 to update the status of these registers.

Table 109. Reserved Register

Address	Bits	Bit Name	Description
0x0D0A	[7:0]	Reserved	Reserved.

Table 110. Input Reference Status¹

Address	Bits	Bit Name	Description
0x0D0B	7	B valid	REFB is valid for use. (It is unfaulted, and its validation timer has expired.)
	6	B fault	REFB is not valid for use.
	5	B fast	This bit indicates that the frequency of REFB is higher than allowed by its profile settings.
	4	B slow	This bit indicates that the frequency of REFB is lower than allowed by its profile settings.
	3	A valid	REFA is valid for use. (It is unfaulted, and its validation timer has expired.)
	2	A fault	REFA is not valid for use.
	1	A fast	This bit indicates that the frequency of REFA is higher than allowed by its profile settings.
	0	A slow	This bit indicates that the frequency of REFA is lower than allowed by its profile settings.
0x0D0C	7	D valid	REFD is valid for use. (It is unfaulted, and its validation timer has expired.)
	6	D fault	REFD is not valid for use.
	5	D fast	This bit indicates that the frequency of REFD is higher than allowed by its profile settings.
	4	D slow	This bit indicates that the frequency of REFD is lower than allowed by its profile settings.
	3	C valid	REFC is valid for use. (It is unfaulted, and its validation timer has expired.)
	2	C fault	REFC is not valid for use.
	1	C fast	This bit indicates that the frequency of REFC is higher than allowed by its profile settings.
	0	C slow	This bit indicates that the frequency of REFC is lower than allowed by its profile settings.

¹Note that the user must issue an I/O update by writing 0x01 to Register 0x0005 to update the status of these registers. Also note that if the fast and slow bits are both set, it means that the clock is missing on that reference input.

Table 111. Holdover History¹

Address	Bits	Bit Name	Description
0x0D0D	[7:0]	Holdover history	Tuning word readback bits[7:0]
0x0D0E	[7:0]		Tuning word readback bits[15:8]
0x0D0F	[7:0]		Tuning word readback bits[23:9]
0x0D10	[7:0]		Tuning word readback bits[29:24]

¹Note that these registers contain the current 30-bit DCO frequency tuning word generated by the tuning word history logic.

Table 112. Digital PLL Lock Detect Tub Levels¹

Address	Bits	Bit Name	Description
0x0D11	[7:0]	Phase tub	Read-only digital PLL lock detect bathtub level, Bits[7:0]; see the DPLL Frequency Lock Detector section for details.
0x0D12	[7:4]		Reserved.
	[3:0]	Read-only digital PLL lock detect bathtub level, Bits[11:8]; see the DPLL Frequency Lock Detector section for details.	
0x0D13	[7:0]	Frequency tub	Read-only digital PLL lock detect bathtub level, Bits[7:0]; see the DPLL Phase Lock Detector section for details.
0x0D14	[7:4]	Reserved	Reserved.
	[3:0]	Frequency tub	Read-only digital PLL lock detect bathtub level, Bits[11:8]; see the DPLL Phase Lock Detector section for details.

¹These registers contain the current digital PLL lock detection bathtub levels.

EEPROM CONTROL (REGISTER 0x0E00 TO REGISTER 0x0E03)

Table 113. EEPROM Control

Address	Bits	Bit Name	Description
0x0E00	[7:1]	Reserved	Reserved.
	0	Write enable	EEPROM write enable/protect. This bit is live, meaning that the user does not need to issue an I/O update after writing it. 0 (default) = EEPROM write protected. 1 = EEPROM write enabled.
0x0E01	[7:4]	Reserved	Reserved.
	[3:0]	Conditional value	When set to a nonzero value, it establishes the condition for EEPROM downloads. This bit is live, meaning that the user does not need to issue an I/O update after writing it. Default: 0x0.
0x0E02	[7:1]	Reserved	Reserved.
	0	Save to EEPROM	Uploads data to the EEPROM based on the EEPROM Storage Sequence (Register 0x0E10 to Register 0x0E3C) section. This is an autoclearing live bit, meaning that the EEPROM load begins immediately after writing this bit (I/O update not needed). To ensure robust operation, the EEPROM upload must be allowed to complete (Register 0x0D00, Bit 1 returning to 0b) before other register writes are performed. If the EEPROM download is interrupted, the user may need to reset the AD9558 prior to attempting another EEPROM operation.
0x0E03	[7:2]	Reserved	Reserved.
	1	Load from EEPROM	Downloads data from the EEPROM. This is an autoclearing live bit, meaning that the EEPROM load begins immediately after writing this bit (I/O update not needed). To ensure robust operation, the EEPROM download must be allowed to complete (Register 0x0D00, Bit 1 returning to 0b) before other register writes are performed. If the EEPROM download is interrupted, the user may need to reset the AD9558 prior to attempting another EEPROM operation.
	0	Reserved	Reserved.

EEPROM STORAGE SEQUENCE (REGISTER 0x0E10 TO REGISTER 0x0E3C)

The default settings of Register 0x0E10 to Register 0x0E3C contain the default EEPROM instruction sequence. The tables in this section provide descriptions of the register defaults, based on the assumption that the controller has been instructed to carry out an EEPROM storage sequence in which all of the registers are stored and loaded by the EEPROM.

Table 114. EEPROM Storage Sequence for System Clock Settings

Address	Bits	Bit Name	Description
0x0E10	[7:0]	EEPROM ID	The default value of this register is 0x01, which the controller interprets as a data instruction. Its decimal value is 1, so this tells the controller to transfer two bytes of data (1 + 1), beginning at the address that is specified by the next two bytes. The controller stores 0x01 in the EEPROM and increments the EEPROM address pointer.
0x0E11	[7:0]		The default value of these two registers is 0x0006. Note that Register 0x0E11 and Register 0x0E12 are the most significant and least significant bytes of the target address, respectively. Because the previous register contains a data instruction, these two registers define a starting address (in this case, 0x0006). The controller stores 0x0006 in the EEPROM and increments the EEPROM pointer by 2. It then transfers two bytes from the register map (beginning at Address 0x0006) to the EEPROM and increments the EEPROM address pointer by 3 (two data bytes and one checksum byte). The two bytes transferred correspond to the system clock parameters in the register map.
0x0E12	[7:0]		
0x0E13	[7:0]	System clock	
0x0E14	[7:0]		The default value of these two registers is 0x0100. Note that Register 0x0E14 and Register 0x0E15 are the most significant and least significant bytes of the target address, respectively. Because the previous register contains a data instruction, these two registers define a starting address (in this case, 0x0100). The controller stores 0x0100 in the EEPROM and increments the EEPROM pointer by 2. It then transfers nine bytes from the register map (beginning at Address 0x0100) to the EEPROM and increments the EEPROM address pointer by 10 (nine data bytes and one checksum byte). The nine bytes transferred correspond to the system clock parameters in the register map.
0x0E15	[7:0]		
0x0E16	[7:0]	I/O update	The default value of this register is 0x80, which the controller interprets as an I/O update instruction. The controller stores 0x80 in the EEPROM and increments the EEPROM address pointer.

Table 115. EEPROM Storage Sequence for General Configuration Settings

Address	Bits	Bit Name	Description
0x0E17	[7:0]	General	The default value of this register is 0x11, which the controller interprets as a data instruction. Its decimal value is 17, which tells the controller to transfer 18 bytes of data (17 + 1), beginning at the address that is specified by the next two bytes. The controller stores 0x11 in the EEPROM and increments the EEPROM address pointer.
0x0E18	[7:0]		The default value of these two registers is 0x0200. Note that Register 0x0E18 and Register 0x0E19 are the most significant and least significant bytes of the target address, respectively. Because the previous register contains a data instruction, these two registers define a starting address (in this case, 0x0200). The controller stores 0x0200 in the EEPROM and increments the EEPROM pointer by 2. It then transfers 18 bytes from the register map (beginning at Address 0x0200) to the EEPROM and increments the EEPROM address pointer by 19 (18 data bytes and one checksum byte). The 18 bytes transferred correspond to the general configuration parameters in the register map.
0x0E19	[7:0]		

Table 116. EEPROM Storage Sequence for DPLL Settings

Address	Bits	Bit Name	Description
0x0E1A	[7:0]	DPLL	The default value of this register is 0x2E, which the controller interprets as a data instruction. Its decimal value is 46, which tells the controller to transfer 47 bytes of data (46 + 1), beginning at the address that is specified by the next two bytes. The controller stores 0x2E in the EEPROM and increments the EEPROM address pointer.
0x0E1B	[7:0]		The default value of these two registers is 0x03. Note that Register 0x0E1B and Register 0x0E1C are the most significant and least significant bytes of the target address, respectively. Because the previous register contains a data instruction, these two registers define a starting address (in this case, 0x0300). The controller stores 0x0300 in the EEPROM and increments the EEPROM pointer by 2. It then transfers 47 bytes from the register map (beginning at Address 0x0300) to the EEPROM and increments the EEPROM address pointer by 48 (47 data bytes and one checksum byte). The 47 bytes transferred correspond to the DPLL parameters in the register map.
0x0E1C	[7:0]		

Table 117. EEPROM Storage Sequence for Output PLL Settings

Address	Bits	Bit Name	Description
0x0E1D	[7:0]	APLL	The default value of this register is 0x08, which the controller interprets as a data instruction. Its decimal value is 8, which tells the controller to transfer nine bytes of data (8 + 1), beginning at the address that is specified by the next two bytes. The controller stores 0x08 in the EEPROM and increments the EEPROM address pointer.
0x0E1E	[7:0]		The default value of these two registers is 0x0400. Note that Register 0x0E1E and Register 0x0E1F are the most significant and least significant bytes of the target address, respectively. Because the previous register contains a data instruction, these two registers define a starting address (in this case, 0x0400). The controller stores 0x0400 in the EEPROM and increments the EEPROM pointer by 2. It then transfers nine bytes from the register map (beginning at Address 0x0400) to the EEPROM and increments the EEPROM address pointer by 10 (nine data bytes and one checksum byte). The nine bytes transferred correspond to APLL parameters in the register map.
0x0E1F	[7:0]		

Table 118. EEPROM Storage Sequence for Clock Distribution Settings

Address	Bits	Bit Name	Description
0x0E20	[7:0]	Clock distribution	The default value of this register is 0x15, which the controller interprets as a data instruction. Its decimal value is 21, which tells the controller to transfer 22 bytes of data (21+1), beginning at the address that is specified by the next two bytes. The controller stores 0x15 in the EEPROM and increments the EEPROM address pointer.
0x0E21	[7:0]		The default value of these two registers is 0x0500. Note that Register 0x0E21 and Register 0x0E22 are the most significant and least significant bytes of the target address, respectively. Because the previous register contains a data instruction, these two registers define a starting address (in this case, 0x0500). The controller stores 0x0500 in the EEPROM and increments the EEPROM pointer by 2. It then transfers 22 bytes from the register map (beginning at Address 0x0500) to the EEPROM and increments the EEPROM address pointer by 23 (22 data bytes and one checksum byte). The 22 bytes transferred correspond to the clock distribution parameters in the register map.
0x0E22	[7:0]		
0x0E23	[7:0]	I/O update	The default value of this register is 0x80, which the controller interprets as an I/O update instruction. The controller stores 0x80 in the EEPROM and increments the EEPROM address pointer.

Table 119. EEPROM Storage Sequence for Reference Input Settings

Address	Bits	Bit Name	Description
0x0E24	[7:0]	Reference inputs	The default value of this register is 0x03, which the controller interprets as a data instruction. Its decimal value is 3, so this tells the controller to transfer four bytes of data (3 + 1), beginning at the address that is specified by the next two bytes. The controller stores 0x03 in the EEPROM and increments the EEPROM address pointer.
0x0E25	[7:0]		The default value of these two registers is 0x0600. Note that Register 0x0E25 and Register 0x0E26 are the most significant and least significant bytes of the target address, respectively. Because the previous register contains a data instruction, these two registers define a starting address (in this case, 0x0600). The controller stores 0x0600 in the EEPROM and increments the EEPROM pointer by 2. It then transfers four bytes from the register map (beginning at Address 0x0600) to the EEPROM and increments the EEPROM address pointer by 5 (four data bytes and one checksum byte). The four bytes that are transferred correspond to the reference inputs parameters in the register map.
0x0E26	[7:0]		

Table 120. EEPROM Storage Sequence for Frame Sync Settings

Address	Bit	Bit Name	Description
0x0E27	[7:0]	Frame sync	The default value of this register is 0x01, which the controller interprets as a data instruction. Its decimal value is 1, which tells the controller to transfer two bytes of data (1 + 1), beginning at the address specified by the next two bytes. The controller stores 0x01 in the EEPROM and increments the EEPROM address pointer.
0x0E28	[7:0]		The default value of these two registers is 0x0640. Note that Register 0x0E28 and Register 0x0E29 are the most significant and least significant bytes of the target address, respectively. Because the previous register contains a data instruction, these two registers define a starting address (in this case, 0x0640). The controller stores 0x0640 in the EEPROM and increments the EEPROM pointer by 2. It then transfers two bytes from the register map (beginning at Address 0x0640) to the EEPROM and increments the EEPROM address pointer by 3 (two data bytes and one checksum byte). The two bytes transferred correspond to the reference inputs parameters in the register map.
0x0E29	[7:0]		

Table 121. EEPROM Storage Sequence for REFA Profile Settings

Address	Bits	Bit Name	Description
0x0E2A	[7:0]	REFA Profile	The default value of this register is 0x26, which the controller interprets as a data instruction. Its decimal value is 38, so this tells the controller to transfer 39 bytes of data (38 + 1), beginning at the address that is specified by the next two bytes. The controller stores 0x26 in the EEPROM and increments the EEPROM address pointer. The default value of these two registers is 0x0700. Note that Register 0x0E2B and Register 0x0E2C are the most significant and least significant bytes of the target address, respectively. Because the previous register contains a data instruction, these two registers define a starting address (in this case, 0x0700). The controller stores 0x0700 in the EEPROM and increments the EEPROM pointer by 2. It then transfers 39 bytes from the register map (beginning at Address 0x0700) to the EEPROM and increments the EEPROM address pointer by 40 (39 data bytes and one checksum byte). The 39 bytes transferred correspond to the REFA profile parameters in the register map.
0x0E2B	[7:0]		
0x0E2C	[7:0]		

Table 122. EEPROM Storage Sequence for REFB Profile Settings

Address	Bits	Bit Name	Description
0x0E2D	[7:0]	REFB profile	The default value of this register is 0x26, which the controller interprets as a data instruction. Its decimal value is 38, so this tells the controller to transfer 39 bytes of data (38 + 1), beginning at the address that is specified by the next two bytes. The controller stores 0x26 in the EEPROM and increments the EEPROM address pointer. The default value of these two registers is 0x0740. Note that Register 0x0E2E and Register 0x0E2F are the most significant and least significant bytes of the target address, respectively. Because the previous register contains a data instruction, these two registers define a starting address (in this case, 0x0740). The controller stores 0x0740 in the EEPROM and increments the EEPROM pointer by 2. It then transfers 39 bytes from the register map (beginning at Address 0x0740) to the EEPROM and increments the EEPROM address pointer by 40 (39 data bytes and one checksum byte). The 39 bytes transferred correspond to the REFB profile parameters in the register map.
0x0E2E	[7:0]		
0x0E2F	[7:0]		

Table 123. EEPROM Storage Sequence for REFC Profile Settings

Address	Bits	Bit Name	Description
0x0E30	[7:0]	REFC profile	The default value of this register is 0x26, which the controller interprets as a data instruction. Its decimal value is 38, so this tells the controller to transfer 39 bytes of data (38 + 1), beginning at the address that is specified by the next two bytes. The controller stores 0x26 in the EEPROM and increments the EEPROM address pointer. The default value of these two registers is 0x0780. Note that Register 0x0E31 and Register 0x0E32 are the most significant and least significant bytes of the target address, respectively. Because the previous register contains a data instruction, these two registers define a starting address (in this case, 0x0780). The controller stores 0x0780 in the EEPROM and increments the EEPROM pointer by 2. It then transfers 39 bytes from the register map (beginning at Address 0x0780) to the EEPROM and increments the EEPROM address pointer by 40 (39 data bytes and one checksum byte). The 39 bytes transferred correspond to the REFC profile parameters in the register map.
0x0E31	[7:0]		
0x0E32	[7:0]		

Table 124. EEPROM Storage Sequence for REFD Profile Settings

Address	Bits	Bit Name	Description
0x0E33	[7:0]	REFD profile	The default value of this register is 0x26, which the controller interprets as a data instruction. Its decimal value is 38, so this tells the controller to transfer 39 bytes of data (38 + 1), beginning at the address that is specified by the next two bytes. The controller stores 0x26 in the EEPROM and increments the EEPROM address pointer. The default value of these two registers is 0x07C0. Note that Register 0x0E34 and Register 0x0E35 are the most significant and least significant bytes of the target address, respectively. Because the previous register contains a data instruction, these two registers define a starting address (in this case, 0x07C0). The controller stores 0x07C0 in the EEPROM and increments the EEPROM pointer by 2. It then transfers 39 bytes from the register map (beginning at Address 0x07C0) to the EEPROM and increments the EEPROM address pointer by 40 (39 data bytes and one checksum byte). The 39 bytes transferred correspond to the REFD profile parameters in the register map.
0x0E34	[7:0]		
0x0E35	[7:0]		

Table 125. EEPROM Storage Sequence for Operational Control Settings

Address	Bits	Bit Name	Description
0x0E37	[7:0]	Operational controls	The default value of this register is 0x0D, which the controller interprets as a data instruction. Its decimal value is 13, so this tells the controller to transfer 14 bytes of data (13 + 1), beginning at the address specified by the next two bytes. The controller stores 0x0D in the EEPROM and increments the EEPROM address pointer.
0x0E38	[7:0]		The default value of these two registers is 0x0A00. Note that Register 0x0E38 and Register 0x0E39 are the most significant and least significant bytes of the target address, respectively. Because the previous register contains a data instruction, these two registers define a starting address (in this case, 0x0A00). The controller stores 0x0A00 in the EEPROM and increments the EEPROM pointer by 2. It then transfers 14 bytes from the register map (beginning at Address 0x0A00) to the EEPROM and increments the EEPROM address pointer by 15 (14 data bytes and one checksum byte). The 14 bytes transferred correspond to the operational controls parameters in the register map.
0x0E39	[7:0]		

Table 126. EEPROM Storage Sequence for APLL Calibration

Address	Bits	Bit Name	Description
0x0E3A	[7:0]	Calibrate APLL	The default value of this register is 0xA0, which the controller interprets as a calibrate instruction. The controller stores 0xA0 in the EEPROM and increments the EEPROM address pointer.
0x0E3B	[7:0]	I/O update	The default value of this register is 0x80, which the controller interprets as an I/O update instruction. The controller stores 0x80 in the EEPROM and increments the EEPROM address pointer.

Table 127. EEPROM Storage Sequence for End of Data

Address	Bits	Bit Name	Description
0x0E3C	[7:0]	End of data	The default value of this register is 0xFF, which the controller interprets as an end instruction. The controller stores this instruction in the EEPROM, resets the EEPROM address pointer, and enters an idle state. Note that if this is a pause rather than an end instruction, the controller actions are the same except that the controller increments the EEPROM address pointer rather than resetting it.

Table 128. Available for Additional EEPROM Instructions

Address	Bits	Bit Name	Description
0x0E3D to 0xE45	[7:0]	Unused	This area is available for additional EEPROM instructions.

Table 129. Multifunction Pin Output Functions (D7 = 1)

Register Value	Output Function	Equivalent Status Register
0x80	Static Logic 0	None
0x81	Static Logic 1	None
0x82	System clock divided by 32	None
0x83	Watchdog timer output	None
0x84	EEPROM upload in progress	Register 0x0D00, Bit 0
0x85	EEPROM download in progress	Register 0x0D00, Bit 1
0x86	EEPROM fault detected	Register 0x0D00, Bit 2
0x87	SYSCLK PLL lock detected	Register 0x0D01, Bit 0
0x88	SYSCLK PLL stable	Register 0x0D01, Bit 1
0x89	Output PLL locked	Register 0x0D01, Bit 2
0x8A	APLL calibration in process	Register 0x0D01, Bit 3
0x8B	APLL input reference present	Register 0x0D01, Bit 4
0x8C	All PLLs locked (DPLL phase lock) and (APLL lock) and (system PLL lock)	Register 0x0D01, Bit 5
0x8D	DPLL phase lock and APLL lock	Register 0x0D01, Bit 6
0x8E	Reserved	Not applicable
0x8F	Reserved	Not applicable
0x90	DPLL free run	Register 0x0D08, Bit 0
0x91	DPLL active	Register 0x0D08, Bit 1
0x92	DPLL in holdover	Register 0x0D08, Bit 2
0x93	DPLL in reference switchover	Register 0x0D08, Bit 3
0x94	DPLL phase locked	Register 0x0D08, Bit 4
0x95	DPLL frequency locked	Register 0x0D08, Bit 5
0x96	DPLL phase slew limited	Register 0x0D08, Bit 6
0x97	DPLL frequency clamped	Register 0x0D09, Bit 5
0x98	Tuning word history available	Register 0x0D09, Bit 4
0x99	Tuning word history updated	Register 0x0D05, Bit 4
0x9A to 0x9F	Reserved	Not applicable
0xA0	Reference A fault	Register 0x0D0B, Bit 2
0xA1	Reference B fault	Register 0x0D0B, Bit 6
0xA2	Reference C fault	Register 0x0D0C, Bit 2
0xA3	Reference D fault	Register 0x0D0C, Bit 6
0xA4 to Ax2F	Reserved	Not applicable
0xB0	Reference A valid	Register 0x0D0B, Bit 3
0xB1	Reference B valid	Register 0x0D0B, Bit 7
0xB2	Reference C valid	Register 0x0D0C, Bit 3
0xB3	Reference D valid	Register 0x0D0C, Bit 7
0xB4 to 0xBF	Reserved	Not applicable
0xC0	Reference A active	Register 0x0D09, Bits[1:0]
0xC1	Reference B active	Register 0x0D09, Bits[1:0]
0xC2	Reference C active	Register 0x0D09, Bits[1:0]
0xC3	Reference D active	Register 0x0D09, Bits[1:0]
0xC4 to 0xCF	Reserved	Not applicable
0xD0	Clock distribution sync pulse	Register 0x0D03, Bit 3
0xD1	Soft pin configuration in progress	Register 0x0D03, Bit 4
0xD2 to 0xFF	Reserved	Not applicable

Table 130. Multifunction Pin Input Functions (D7 = 0)

Register Value	Input Function	Equivalent Control Register
0x00	Reserved, high-Z input	Not applicable
0x01	I/O update	Register 0x0005, Bit 0
0x02	Full power-down	Register 0x0A00, Bit 0
0x03	Clear watchdog	Register 0x0A03, Bit 0
0x04	Clear all IRQs	Register 0x0A03, Bit 1
0x05	Tuning word history reset	Register 0x0A03, Bit 2
0x06 to 0x0E	Reserved	Not applicable
0x10	User holdover	Register 0x0A01, Bit 6
0x11	User free run	Register 0x0A01, Bit 5
0x12	Reset incremental phase offset	Register 0x0A0A, Bit 2
0x13	Increment incremental phase offset	Register 0x0A0A, Bit 0
0x14	Decrement incremental phase offset	Register 0x0A0A, Bit 1
0x15 to 0x1F	Reserved	Not applicable
0x20	Override Reference Monitor A	Register 0x0A0C, Bit 0
0x21	Override Reference Monitor B	Register 0x0A0C, Bit 1
0x22	Override Reference Monitor C	Register 0x0A0C, Bit 2
0x23	Override Reference Monitor D	Register 0x0A0C, Bit 3
0x24 to 0x2F	Reserved	Not applicable
0x30	Force Validation Timeout A	Register 0x0A0B, Bit 0
0x31	Force Validation Timeout B	Register 0x0A0B, Bit 1
0x32	Force Validation Timeout C	Register 0x0A0B, Bit 2
0x33	Force Validation Timeout D	Register 0x0A0B, Bit 3
0x34 to 0x3F	Reserved	Not applicable
0x40	Enable OUT0	Register 0x0501, Bit 0
0x41	Enable OUT1	Register 0x0505, Bit 0
0x42	Enable OUT2	Register 0x0506, Bit 0
0x43	Enable OUT3	Register 0x050A, Bit 0
0x44	Enable OUT4	Register 0x050B, Bit 0
0x45	Enable OUT5	Register 0x050F, Bit 0
0x46	Enable OUT0, OUT1, OUT2, OUT3, OUT4, OUT5	Register 0x0501/Register 0x0505/Register 0x0506/ Register 0x050A/Register 0x050B/Register 0x050F, Bit 0
0x47	Soft sync clock distribution outputs	Register 0x0A02, Bit 1
0x48 to 0x7F	Reserved	Not applicable

OUTLINE DIMENSIONS

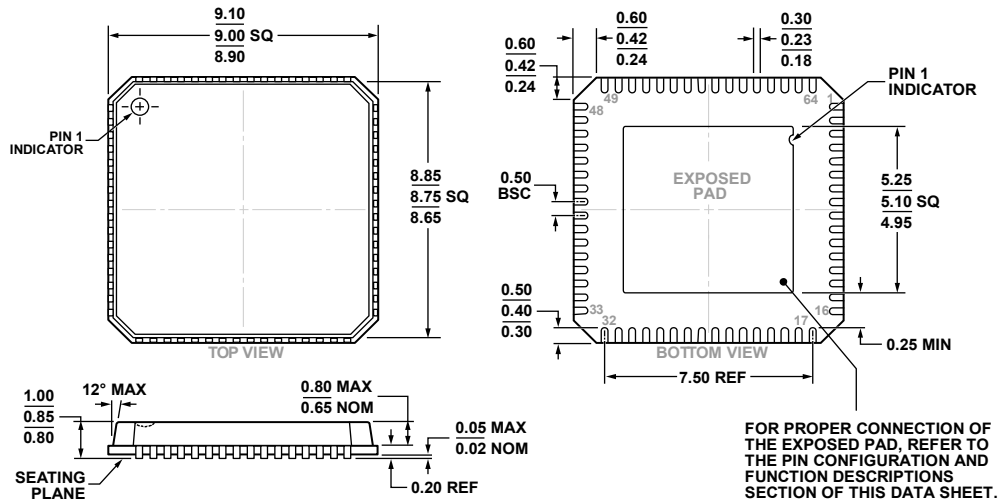

COMPLIANT TO JEDEC STANDARDS MO-220-VMM4

Figure 61. 64-Lead Lead Frame Chip Scale Package [LFCSP_VQ]
 9 mm × 9 mm Body, Very Thin Quad
 (CP-64-5)
 Dimensions shown in millimeters

ORDERING GUIDE

Model ¹	Temperature Range	Package Description	Package Option
AD9558BCPZ	-40°C to +85°C	64-Lead Lead Frame Chip Scale Package [LFCSP_VQ]	CP-64-5
AD9558BCPZ-REEL7	-40°C to +85°C	64-Lead Lead Frame Chip Scale Package [LFCSP_VQ]	CP-64-5
AD9558/PCBZ		Evaluation Board	

¹ Z = RoHS Compliant Part.

¹C refers to a communications protocol originally developed by Philips Semiconductors (now NXP Semiconductors).