

### FEATURES

**10-Bit, 100 MSPS ADC**  
**Low Power: 450 mW at 100 MSPS**  
**On-Chip Track/Hold**  
**280 MHz Analog Bandwidth**  
**SINAD = 54 dB @ 41 MHz**  
**On-Chip Reference**  
**1 V p-p Analog Input Range**  
**Single +5 V Supply Operation**  
**+5 V/+3.3 V Outputs**

### APPLICATIONS

**Digital Communications**  
**Signal Intelligence**  
**Digital Oscilloscopes**  
**Spectrum Analyzers**  
**Medical Imaging**  
**Sonar**  
**HDTV**

### GENERAL DESCRIPTION

The AD9071 is a monolithic sampling analog-to-digital converter with an on-chip track-and-hold circuit and TTL/CMOS digital interfaces. The product operates at a 100 MSPS conversion rate with outstanding dynamic performance over its full operating range.

The ADC requires only a single 5 V supply and an encode clock for full performance operation. The digital outputs are TTL compatible. Separate output power supply pins support

### FUNCTIONAL BLOCK DIAGRAM

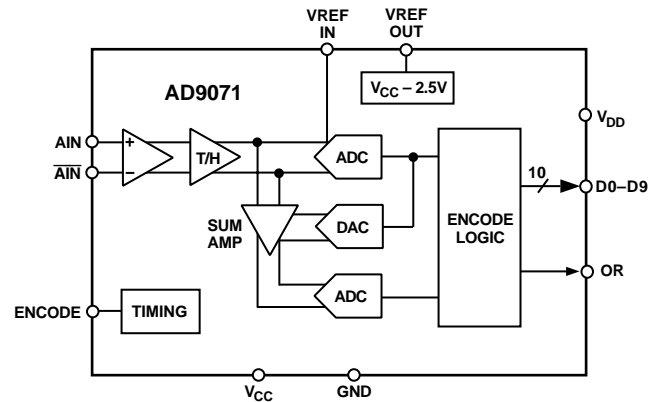

interfacing with 3.3 V or 5 V logic. An out-of-range output (OR) is available that indicates a conversion result is outside the operating range. The output data are held at saturation levels during an out-of-range condition.

The input amplifier supports differential or single-ended interfaces. An internal reference is included.

Fabricated on an advanced BiCMOS process, the AD9071 is available in a plastic SOIC package specified over the industrial temperature range ( $-40^{\circ}\text{C}$  to  $+85^{\circ}\text{C}$ ).

### REV. B

Information furnished by Analog Devices is believed to be accurate and reliable. However, no responsibility is assumed by Analog Devices for its use, nor for any infringements of patents or other rights of third parties which may result from its use. No license is granted by implication or otherwise under any patent or patent rights of Analog Devices.

# AD9071—SPECIFICATIONS ( $V_{CC} = +5\text{ V}$ , $V_{DD} = +3.3\text{ V}$ , Differential Analog Input, ENCODE = 100 MSPS unless otherwise noted)

| Parameter   | Temp  | Test Level | AD9071BR       |                |                | Units   |
|---|-------|------------|----------------|----------------|----------------|---------|
|   |       |            | Min            | Typ            | Max            |         |
| RESOLUTION  |       |            | 10             |                |                | Bits    |
| DC ACCURACY   |       |            |                |                |                |         |
| Differential Nonlinearity <sup>1</sup>                            | +25°C | I          |                | ±0.8           | +1.5/−1.0      | LSB     |
|   | Full  | VI         |                | ±1.0           | +1.75/−1.0     | LSB     |
| Integral Nonlinearity <sup>1</sup>                                | +25°C | I          |                | ±0.8           | ±1.5           | LSB     |
|   | Full  | VI         |                | ±1.25          | ±1.75          | LSB     |
| No Missing Codes <sup>1</sup>                                     | +25°C | I          |                | Guaranteed     |                |         |
| Gain Error <sup>2</sup>   | +25°C | I          |                | ±1             | ±4             | % FS    |
|   | Full  | VI         |                | ±2             | ±8             | % FS    |
| Gain Tempco <sup>2</sup>  | Full  | V          |                | 150            |                | ppm/°C  |
| ANALOG INPUT  |       |            |                |                |                |         |
| Input Voltage Range<br>(With Respect to $\overline{\text{AIN}}$ ) | Full  | V          |                | ±512           |                | mV p-p  |
| Common-Mode Voltage   | Full  | V          |                | −2.5 ± 0.2     |                | V       |
| Input Offset Voltage  | +25°C | I          |                | ±4             | ±18            | mV      |
|   | Full  | VI         |                | ±5             | ±20            | mV      |
| Input Resistance  | Full  | VI         | 15             | 35             |                | kΩ      |
| Input Capacitance   | +25°C | V          |                | 3              |                | pF      |
| Input Bias Current  | +25°C | I          |                | 55             | 90             | μA      |
|   | Full  | VI         |                | 65             | 115            | μA      |
| Analog Bandwidth, Full Power                                      | +25°C | V          |                | 280            |                | MHz     |
| REFERENCE OUTPUT  |       |            |                |                |                |         |
| Output Voltage  | Full  | VI         | $V_{CC} - 2.6$ | $V_{CC} - 2.5$ | $V_{CC} - 2.4$ | V       |
| Temperature Coefficient   | Full  | V          |                | 130            |                | ppm/°C  |
| SWITCHING PERFORMANCE   |       |            |                |                |                |         |
| Maximum Conversion Rate   | Full  | VI         | 100            |                |                | MSPS    |
| Minimum Conversion Rate   | Full  | IV         |                |                | 40             | MSPS    |
| Encode Pulsewidth High ( $t_{EH}$ )                               | +25°C | IV         | 4.5            |                | 13             | ns      |
| Encode Pulsewidth Low ( $t_{EL}$ )                                | +25°C | IV         | 4.5            |                | 13             | ns      |
| Aperture Delay ( $t_A$ )  | +25°C | V          |                | 1.1            |                | ns      |
| Aperture Uncertainty (Jitter)                                     | +25°C | V          |                | 3.0            |                | ps, rms |
| Output Valid Time ( $t_V$ ) <sup>3</sup>                          | Full  | VI         | 2.0            | 4.0            |                | ns      |
| Output Propagation Delay ( $t_{PD}$ ) <sup>3</sup>                | Full  | VI         |                | 5.0            | 7.0            | ns      |
| Output Rise Time ( $t_R$ )  | Full  | V          |                | 1.4            |                | ns      |
| Output Fall Time ( $t_F$ )  | Full  | V          |                | 1.0            |                | ns      |
| DIGITAL INPUT   |       |            |                |                |                |         |
| Logic “1” Voltage   | Full  | VI         | 2.0            |                |                | V       |
| Logic “0” Voltage   | Full  | VI         |                |                | 0.8            | V       |
| Logic “1” Current   | Full  | VI         |                |                | ±10            | μA      |
| Logic “0” Current   | Full  | VI         | −500           |                |                | μA      |
| Input Capacitance   | +25°C | V          |                | 3              |                | pF      |
| DIGITAL OUTPUTS   |       |            |                |                |                |         |
| Logic “1” Voltage   | Full  | VI         | $V_{DD} - 0.5$ |                |                | V       |
| Logic “0” Voltage   | Full  | VI         |                |                | 0.05           | V       |
| Output Coding   |       |            |                | Offset Binary  |                |         |
| POWER SUPPLY  |       |            |                |                |                |         |
| $V_{CC}$ Supply Current ( $V_{CC} = 5\text{ V}$ ) <sup>4</sup>    | Full  | VI         |                | 85             | 115            | mA      |
| $V_{DD}$ Supply Current ( $V_{DD} = 3.3\text{ V}$ ) <sup>4</sup>  | Full  | VI         |                | 7.5            | 14             | mA      |
| Power Dissipation <sup>4</sup>                                    | Full  | VI         |                | 450            | 620            | mW      |
| Power Supply Sensitivity <sup>5</sup>                             | +25°C | I          |                | 0.002          | 0.010          | V/V     |

| Parameter  | Temp  | Test Level | AD9071BR |     |     | Units |
|--|-------|------------|----------|-----|-----|-------|
|  |       |            | Min      | Typ | Max |       |
| <b>DYNAMIC PERFORMANCE<sup>6</sup></b>             |       |            |          |     |     |       |
| Transient Response                                 | +25°C | V          |          | 4   |     | ns    |
| Overvoltage Recovery Time                          | +25°C | V          |          | 5   |     | ns    |
| Signal-to-Noise Ratio (SNR)<br>(Without Harmonics) |       |            |          |     |     |       |
| $f_{IN} = 10.3$ MHz                                | +25°C | I          | 54       | 56  |     | dB    |
|  | Full  | V          |          | 55  |     | dB    |
| $f_{IN} = 41$ MHz                                  | +25°C | I          | 53       | 55  |     | dB    |
|  | Full  | V          |          | 54  |     | dB    |
| Signal-to-Noise Ratio (SINAD)<br>(With Harmonics)  |       |            |          |     |     |       |
| $f_{IN} = 10.3$ MHz                                | +25°C | I          | 54       | 56  |     | dB    |
|  | Full  | V          |          | 55  |     | dB    |
| $f_{IN} = 41$ MHz                                  | +25°C | I          | 52       | 54  |     | dB    |
|  | Full  | V          |          | 53  |     | dB    |
| Effective Number of Bits                           |       |            |          |     |     |       |
| $f_{IN} = 10.3$ MHz                                | +25°C | I          | 8.8      | 9.2 |     | Bits  |
| $f_{IN} = 41$ MHz                                  | +25°C | I          | 8.5      | 8.8 |     | Bits  |
| 2nd Harmonic Distortion                            |       |            |          |     |     |       |
| $f_{IN} = 10.3$ MHz                                | +25°C | I          | 63       | 75  |     | dBc   |
| $f_{IN} = 41$ MHz                                  | +25°C | I          | 60       | 66  |     | dBc   |
| 3rd Harmonic Distortion                            |       |            |          |     |     |       |
| $f_{IN} = 10.3$ MHz                                | +25°C | I          | 65       | 75  |     | dBc   |
| $f_{IN} = 41$ MHz                                  | +25°C | I          | 57       | 65  |     | dBc   |
| Two-Tone Intermodulation (IMD)                     |       |            |          |     |     |       |
| $f_{IN} = 10.3$ MHz                                | +25°C | V          |          | 70  |     | dBc   |
| $f_{IN} = 41$ MHz                                  | +25°C | V          |          | 60  |     | dBc   |

## NOTES

<sup>1</sup>Differential and integral nonlinearity based on  $F_S = 80$  MSPS.

<sup>2</sup>Gain error and gain temperature coefficient are based on the ADC only (with a fixed 2.5 V external reference).

<sup>3</sup> $t_{TV}$  and  $t_{PD}$  are measured from the threshold crossing of the ENCODE input to the 50% levels of the digital outputs. The output ac load during test is 5 pF.

<sup>4</sup>Power dissipation is measured under the following conditions:  $F_S @ 100$  MSPS, analog input is  $-1$  dBFS at 10.3 MHz.

<sup>5</sup>A change in input offset voltage with respect to a change in  $V_{CC}$ .

<sup>6</sup>SNR/harmonics based on an analog input voltage of  $-1.0$  dBFS referenced to a 1.024 V full-scale input range.

Typical thermal impedance for the R style (SOIC) 28-lead package:  $\theta_{JC} = 23^\circ\text{C}/\text{W}$ ,  $\theta_{CA} = 48^\circ\text{C}/\text{W}$ ,  $\theta_{JA} = 71^\circ\text{C}/\text{W}$ .

Specifications subject to change without notice.

## ABSOLUTE MAXIMUM RATINGS\*

|                              |   |
|------------------------------|---|
| $V_{CC}$                     | +6 V  |
| Analog Inputs                | $V_{CC}$ to 0.0 V                           |
| Digital Inputs               | $V_{CC}$ to 0.0 V                           |
| VREF IN, VREF OUT            | $V_{CC}$ to 0.0 V                           |
| Digital Output Current       | 10 mA                                       |
| Operating Temperature        | $-40^\circ\text{C}$ to $+85^\circ\text{C}$  |
| Storage Temperature          | $-65^\circ\text{C}$ to $+150^\circ\text{C}$ |
| Maximum Junction Temperature | $+175^\circ\text{C}$                        |
| Maximum Case Temperature     | $+150^\circ\text{C}$                        |

\*Stresses above those listed under Absolute Maximum Ratings may cause permanent damage to the device. This is a stress rating only; functional operation of the device at these or any other conditions above those indicated in the operational sections of this specification is not implied. Exposure to absolute maximum ratings for extended periods may effect device reliability.

## CAUTION

ESD (electrostatic discharge) sensitive device. Electrostatic charges as high as 4000 V readily accumulate on the human body and test equipment and can discharge without detection. Although the AD9071 features proprietary ESD protection circuitry, permanent damage may occur on devices subjected to high energy electrostatic discharges. Therefore, proper ESD precautions are recommended to avoid performance degradation or loss of functionality.

## EXPLANATION OF TEST LEVELS

## Test Level

- I. 100% production tested.
- II. 100% production tested at  $+25^\circ\text{C}$  and sample tested at specified temperatures.
- III. Sample tested only.
- IV. Parameter is guaranteed by design and characterization testing.
- V. Parameter is a typical value only.
- VI. 100% production tested at  $+25^\circ\text{C}$ ; guaranteed by design and characterization testing for industrial temperature range.



# AD9071

## ORDERING GUIDE

| Model      | Temperature Range | Package Description      | Package Option |
|------------|-------------------|--------------------------|----------------|
| AD9071BR   | -40°C to +85°C    | 28-Lead Wide Body (SOIC) | R-28           |
| AD9071/PCB | +25°C             | Evaluation Board         |                |

## PIN FUNCTION DESCRIPTIONS

| Pin No.          | Name                    | Function   |
|------------------|-------------------------|--|
| 1, 7, 12, 21, 23 | GND                     | Ground.  |
| 2, 8, 11         | V <sub>CC</sub>         | Analog Power Supply. Nominally 5.0 V. (Tie together to prevent a possible latch-up condition.)   |
| 3                | VREF OUT                | Internal Reference Output (V <sub>CC</sub> - 2.5 V typical); Bypass with 0.1 μF to V <sub>CC</sub> .   |
| 4                | VREF IN                 | Reference Input for ADC (V <sub>CC</sub> - 2.5 V typical).   |
| 5, 6             | DNC                     | Do Not Connect.  |
| 9                | $\overline{\text{AIN}}$ | Analog Input – Complementary.  |
| 10               | AIN                     | Analog Input – True.   |
| 13               | ENCODE                  | Encode clock for ADC. (ADC Samples on Rising Edge of ENCODE.)  |
| 14               | OR                      | Out-of-Range Output. Goes HIGH when the converted sample is more positive than 3FF <sub>H</sub> or more negative than 000 <sub>H</sub> (offset binary coding). |
| 15–19, 24–28     | D9–D0                   | Digital outputs of ADC. D9 is the MSB. Data is offset binary.  |
| 20, 22           | V <sub>DD</sub>         | Digital Output Power Supply. User selectable range from 3 V to 5 V.  |

## PIN CONFIGURATION

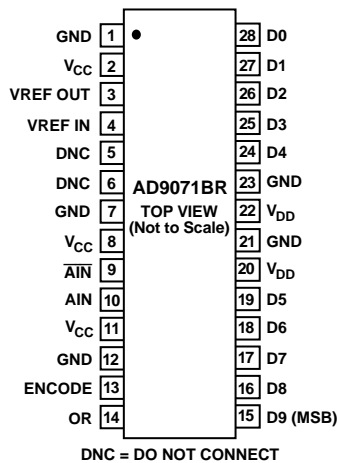

Table I. Output Coding

| Code | AIN- $\overline{\text{AIN}}$ | Offset Binary | OR |
|------|------------------------------|---------------|----|
| 1023 | $\geq 0.512$ V               | 11 1111 1111  | 1  |
| 1023 | 0.511 V                      | 11 1111 1111  | 0  |
| 1022 | 0.510 V                      | 11 1111 1110  | 0  |
| .    | .                            | .             | .  |
| .    | .                            | .             | .  |
| .    | .                            | .             | .  |
| 513  | 0.001 V                      | 10 0000 0001  | 0  |
| 512  | 0.000 V                      | 10 0000 0000  | 0  |
| 511  | -0.001 V                     | 01 1111 1111  | 0  |
| .    | .                            | .             | .  |
| .    | .                            | .             | .  |
| .    | .                            | .             | .  |
| 1    | -0.511 V                     | 00 0000 0001  | 0  |
| 0    | -0.512 V                     | 00 0000 0000  | 0  |
| 0    | $\leq -0.513$ V              | 00 0000 0000  | 1  |

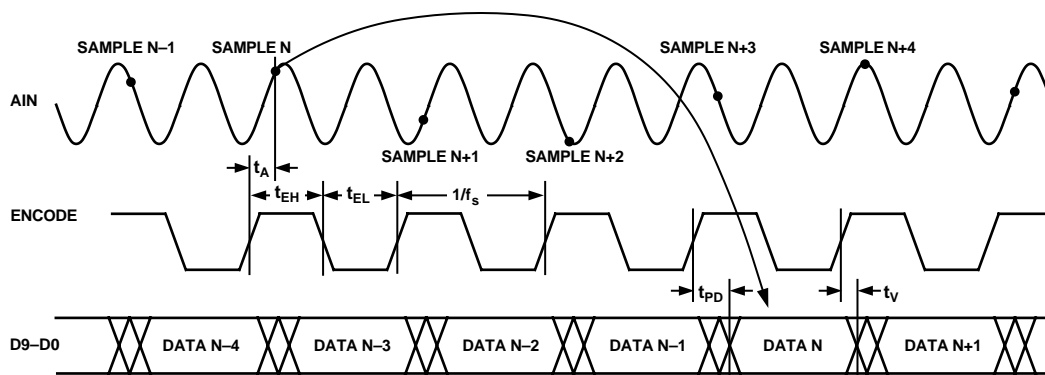

Figure 1. Timing Diagram

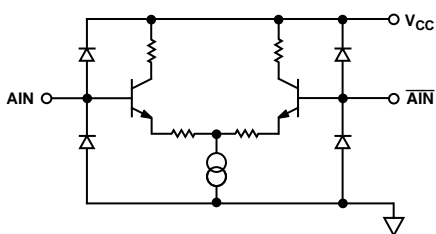

Figure 2. Equivalent Analog Input Circuit

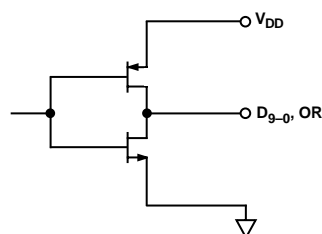

Figure 5. Equivalent Digital Output Circuit

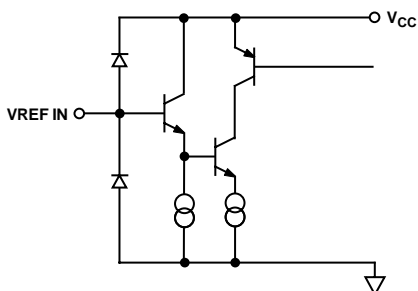

Figure 3. Equivalent Reference Input Circuit

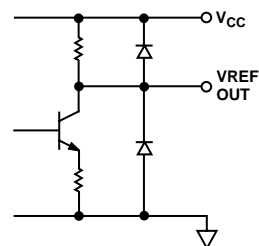

Figure 6. Equivalent Reference Output Circuit

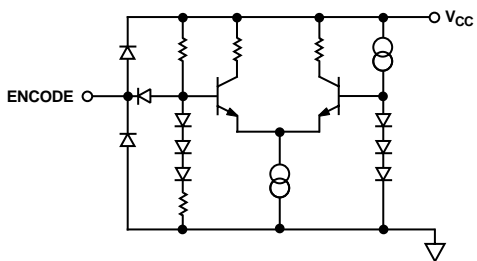

Figure 4. Equivalent Encode Input Circuit

# AD9071—Typical Performance Characteristics

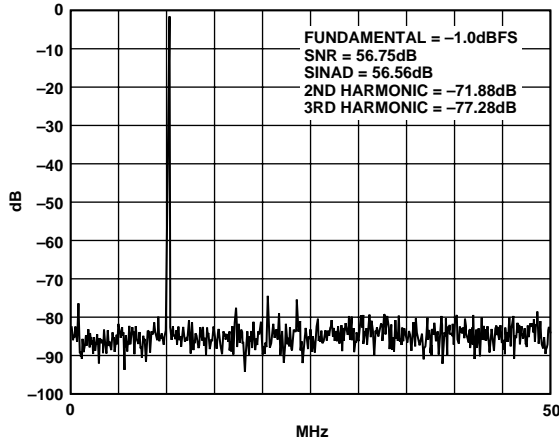

Figure 7. Spectrum:  $F_S = 100$  MSPS,  $f_{IN} = 10.3$  MHz

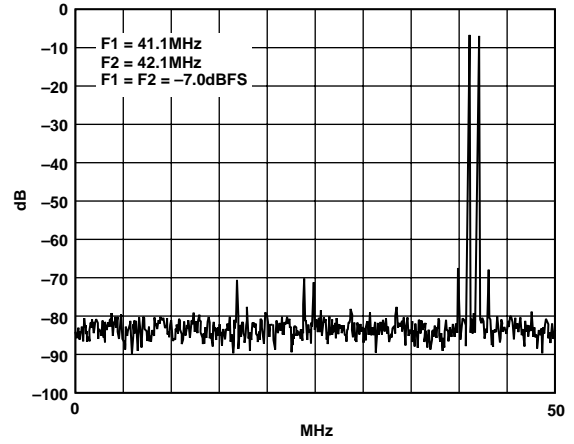

Figure 10. Two-Tone Intermodulation Distortion

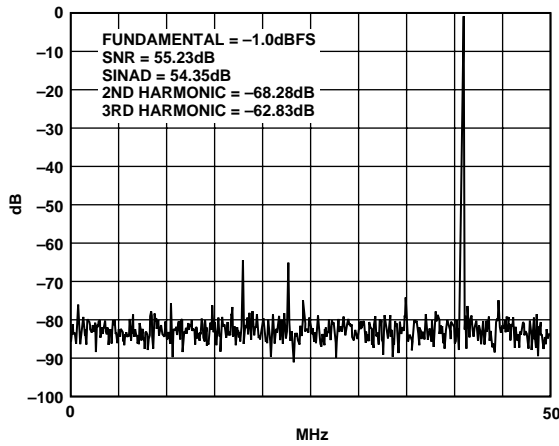

Figure 8. Spectrum:  $F_S = 100$  MSPS,  $f_{IN} = 41$  MHz

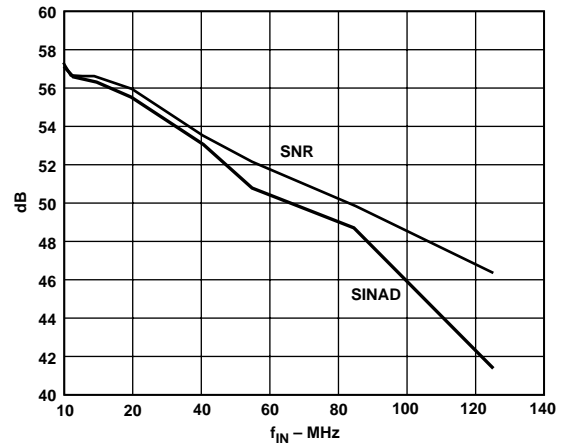

Figure 11. SINAD/SNR vs.  $f_{IN}$ :  $F_S = 100$  MSPS

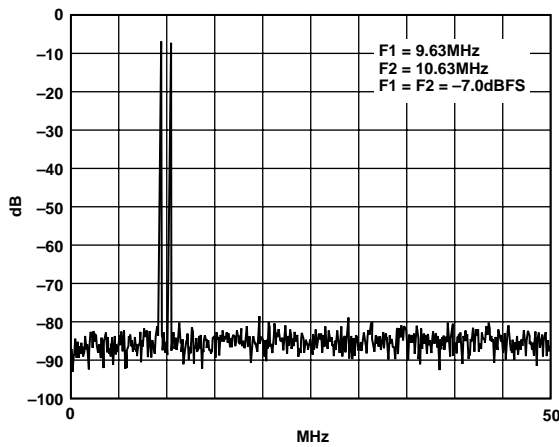

Figure 9. Two-Tone Intermodulation Distortion

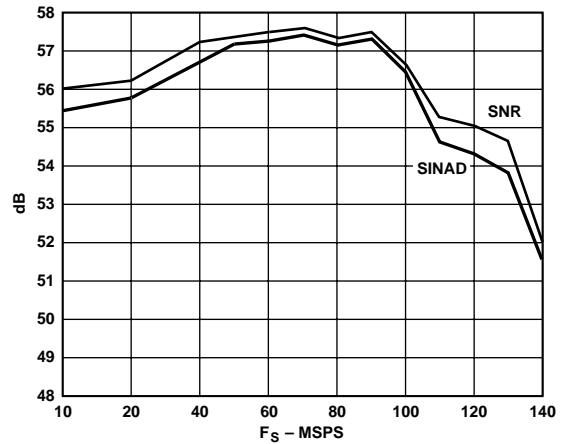

Figure 12. SINAD/SNR vs.  $F_S$ :  $f_{IN} = 10.3$  MHz

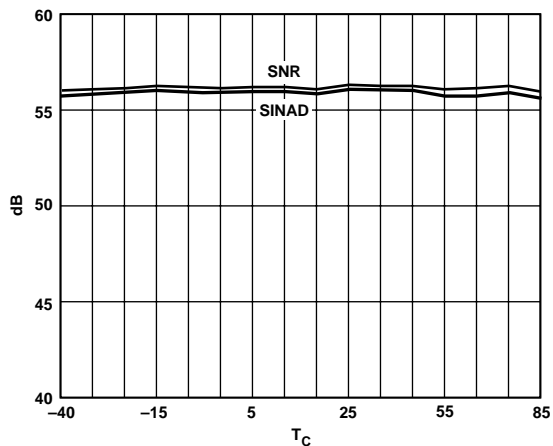

Figure 13. Differential SNR vs.  $T_C$ :  $f_{IN} = 10.3$  MHz

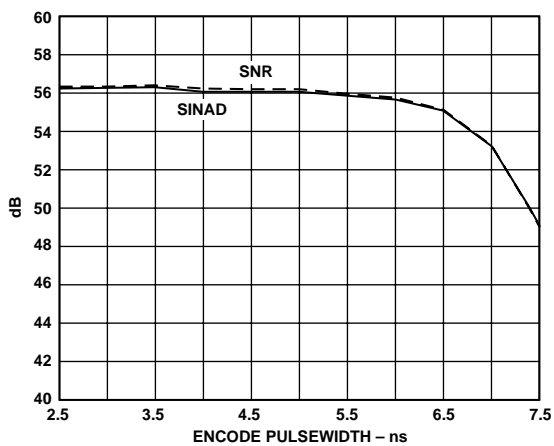

Figure 15. SNR vs. Clock Pulsewidth ( $t_{EH}$ ):  $f_{IN} = 10.3$  MHz

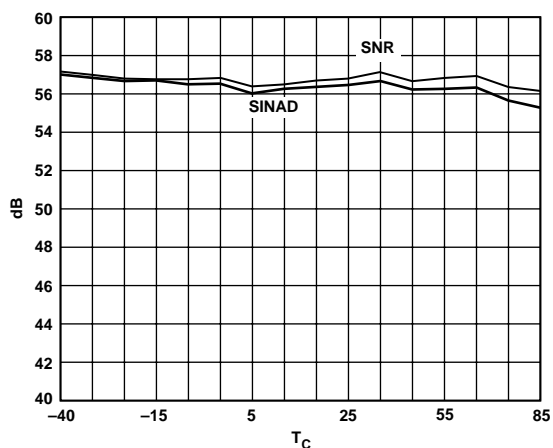

Figure 14. Single-Ended SNR vs.  $T_C$ :  $f_{IN} = 10.3$  MHz

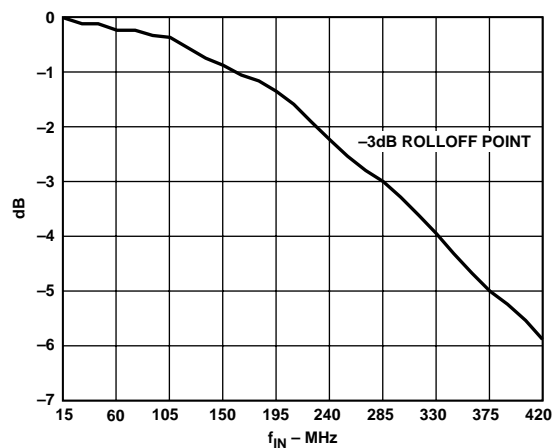

Figure 16. Frequency Response

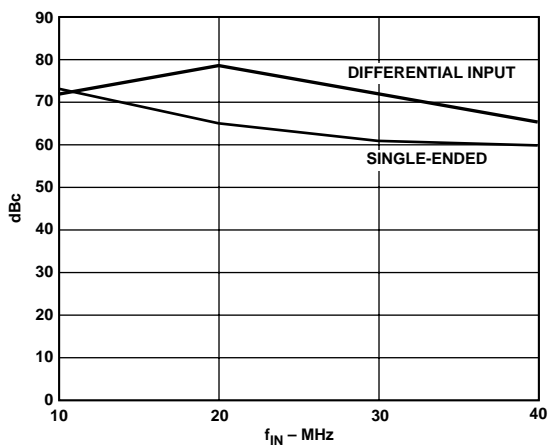

Figure 17. Second Harmonic Performance: Single-Ended vs. Differential Input

# AD9071

## APPLICATION NOTES

### THEORY OF OPERATION

The AD9071 employs a two-step subranging architecture with digital error correction.

The sampling and conversion process is initiated by a rising edge at the ENCODE input. The analog input signal is buffered by a high speed differential amplifier and applied to a track-and-hold (T/H) circuit, which captures the value of the input at the sampling instant and maintains it for the duration of the conversion.

The coarse quantizer (ADC) produces a 5-bit estimate of the input value. Its digital output is reconverted to analog form by the reconstruction DAC and subtracted from the input signal in the SUM AMP. The second stage quantizer generates a 6-bit representation of the difference signal. The eleven bits are presented to the ENCODE LOGIC, which corrects for range overlap errors and produces an accurate 10-bit result.

Data are strobed to the output on the rising edge of the ENCODE input, with the data from sample N appearing on the output following ENCODE rising edge N+3.

### USING THE AD9071

#### ENCODE Input

Any high-speed A/D converter is extremely sensitive to the quality of the sampling clock provided by the user. A track/hold circuit is essentially a mixer, and any noise, distortion, or timing jitter on the clock will be combined with the desired signal at the A/D output. For that reason, considerable care has been taken in the design of the ENCODE input of the AD9071, and the user is advised to give commensurate thought to the clock source. The lowest jitter clock source is a crystal oscillator producing a pure sine wave.

The ENCODE input is fully TTL/CMOS compatible.

#### Digital Outputs

The digital outputs are CMOS compatible for lower power consumption. 200  $\Omega$  series resistors are recommended between the AD9071 and the receiving logic to reduce transients and improve SNR.

#### Analog Input

The analog input has been optimized for differential signal input.

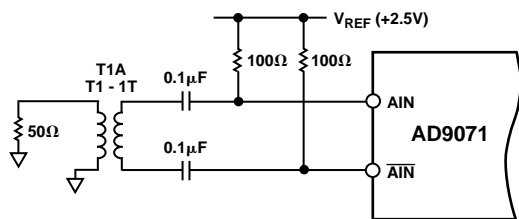

Figure 18. Differential Analog Input Configuration

If driven single-endedly, the  $\overline{\text{AIN}}$  should be connected to a clean reference and bypassed to ground. For best dynamic performance, impedances at AIN and  $\overline{\text{AIN}}$  should match.

Special care was taken in the design of the analog input section of the AD9071 to prevent damage and corruption of data when the input is overdriven. The nominal input range is +1.988 V to +3.012 V (1.024 V p-p centered at +2.5 V). Out-of-range

comparators detect when the analog input signal is out of this range, and set the OR output signal HIGH. The digital outputs are locked at plus or minus full scale ( $3FF_H$  or  $200_H$ ) for voltages that are out of range, but between 1 V and 5 V. Input voltages outside of this range may result in invalid codes at the ADC's output.

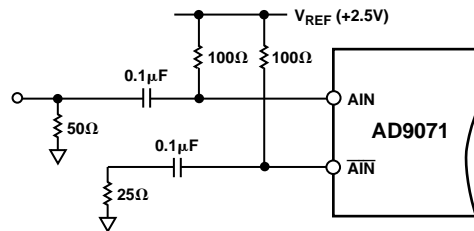

Figure 19. Single-Ended Analog Input Configuration

When the analog input signal returns to the nominal range, the out-of-range comparators return the ADC to its active mode and the device recovers in the overvoltage recovery time.

#### Voltage Reference

A stable and accurate 2.5 V voltage reference ( $V_{CC} - 2.5 \text{ V}$ ) is built into the AD9071 (VREF OUT). In normal operation, the internal reference is used by strapping Pins 3 and 4 of the AD9071 together. The internal reference can provide 100  $\mu\text{A}$  of extra drive current that may be used for other circuits.

Some applications may require greater accuracy, improved temperature performance, or adjustment of the gain of the AD9071, which cannot be obtained by using the internal reference. For these applications, an external 2.5 V reference can be connected to VREF IN, which requires 5  $\mu\text{A}$  of drive current (see Figure 20).

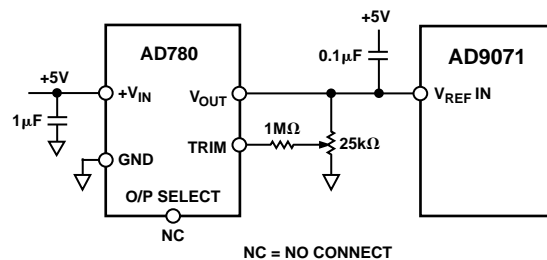

Figure 20. Using the AD780 Voltage Reference

The input range can be adjusted by varying the reference voltage applied to the AD9071. No appreciable degradation in performance occurs when the reference is adjusted  $\pm 4\%$ . The full-scale range of the ADC tracks reference voltage changes linearly.

#### Timing

The performance of the AD9071 is insensitive to the duty cycle of the clock over a wide range of operating conditions (see Figure 15).

The AD9071 provides latched data outputs, with three pipeline delays. Data outputs are available one propagation delay ( $t_{PD}$ ) after the rising edge of the encode command (see Figure 1). The length of the output data lines, and loads placed on them, should be minimized to reduce transients within the AD9071; these transients can detract from the converter's dynamic performance.



The minimum guaranteed conversion rate of the AD9071 is 40 MSPS. At clock rates below 40 MSPS, dynamic performance may degrade. The AD9070 will operate in bursts, but the user must flush the internal pipeline each time the clock restarts. Valid data will be produced on the fourth rising edge of the ENCODE signal after the clock is restarted.

## EVALUATION BOARD

The AD9071 evaluation board is a convenient and easy way to evaluate the performance of the AD9071 in the SOIC package. The board consists of an internal voltage reference or an optional external reference, two 74LCX574 latches for capturing data from the A/D converter, and an AD9760 DAC for viewing reconstructed A/D data. The AD9071 output logic can be driven at 5 V and 3.3 V levels. The latches are set up at 3.3 V but are 5 V tolerant. Test points are provided at Encode, DB9, DB0, Data Ready, and Data Clock. All are clearly labeled.

### Analog Input

The evaluation board can be driven single-ended or differentially. Differential input requires using a 1:1 transformer. For single-ended operation (J2), Jumper S5 is connected to S8 and S6 is connected to S7. For differential input operation (J3), S5 is connected to S3 and S4 is connected to S6. The board is shipped in the differential configuration.

### Encode

The AD9071 encode inputs are driven single-ended into J1 and are at TTL logic levels.

### Data Out

The data delivered out of the AD9071 is in offset binary format at TTL levels. The Data Ready signal can be inverted by opening the S1 and S2 connections. An optional series termination

resistor on Data Ready (R33), normally 0 ohms, is provided to support various user output impedance configurations. The AD9760 DAC supports viewing reconstructed A/D data at J4.

### Voltage Reference

The AD9071 can be operated using its internal voltage reference (connect E2 to E3) or an optional external reference (connect E1 to E2). The board is shipped utilizing the internal voltage reference.

### Layout

The AD9071 is not layout sensitive if some important guidelines are met. The evaluation board layout provides an example where these guidelines have been followed to optimize performance.

- Provide a good ground plane connecting the analog and digital sections.
- Excellent bypassing is essential. Chip capacitors with 0.1  $\mu\text{F}$  values and 0803 dimensions are placed flush against the pins. Placing any of the capacitors on the bottom of the board can degrade performance. These techniques reduce the amount of parasitic inductance that can impact the bypassing ability of the caps.
- Separate power planes and supplies for the analog and digital sections are recommended.

The AD9071 evaluation board is provided as a design example for customers of Analog Devices. ADI makes no warranties express, statutory, or implied regarding merchantability or fitness for a particular purpose.

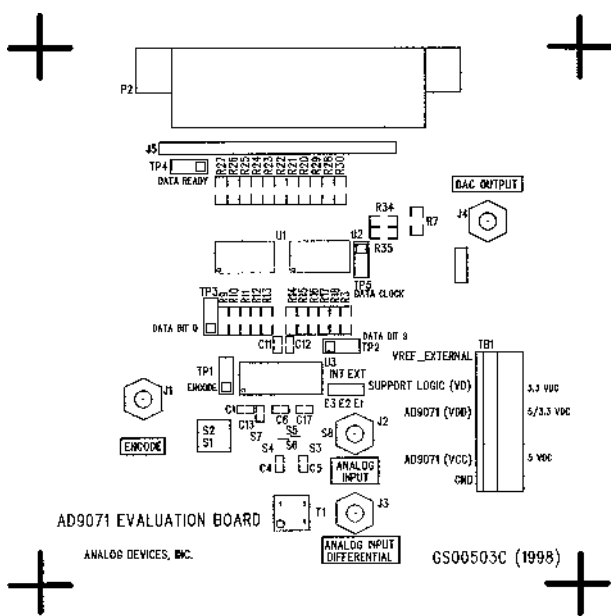

Figure 21. Printed Circuit Board Top Side Silkscreen

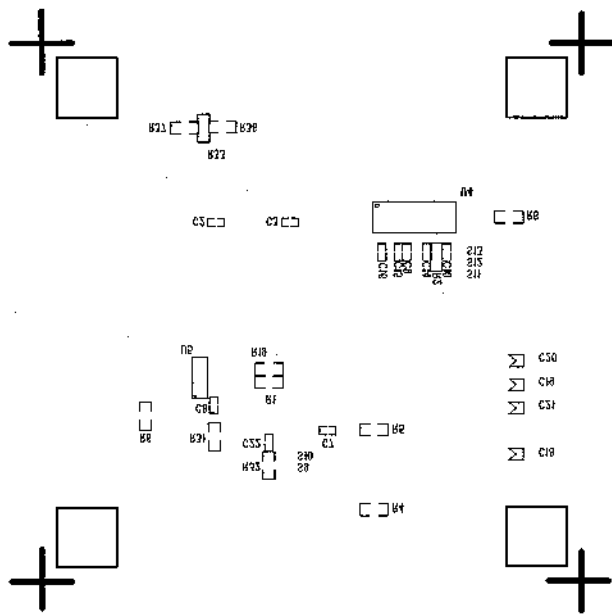

Figure 22. Printed Circuit Board Bottom Side Silkscreen

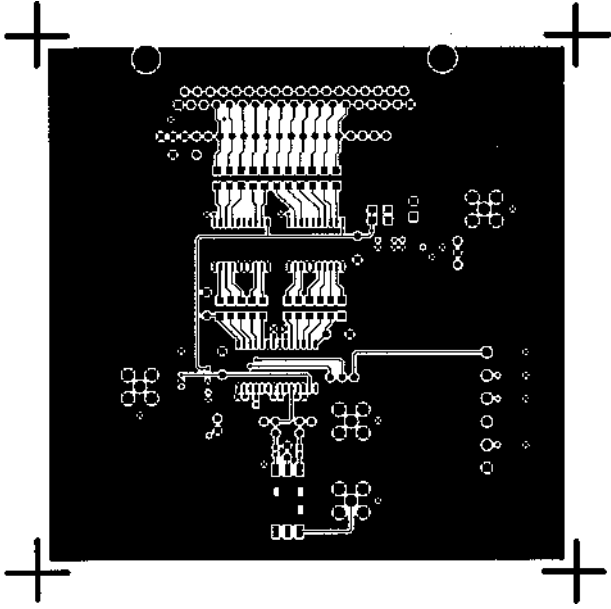

Figure 23. Printed Circuit Board Top Side Copper

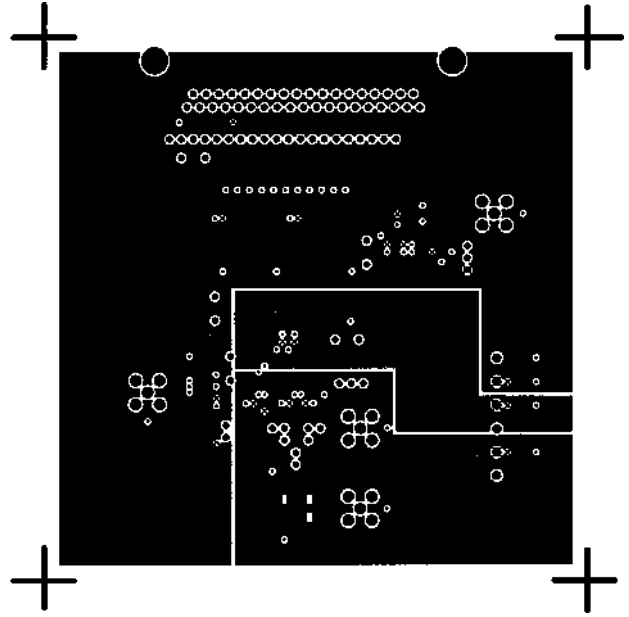

Figure 25. Printed Circuit Board "Split" Power Layer

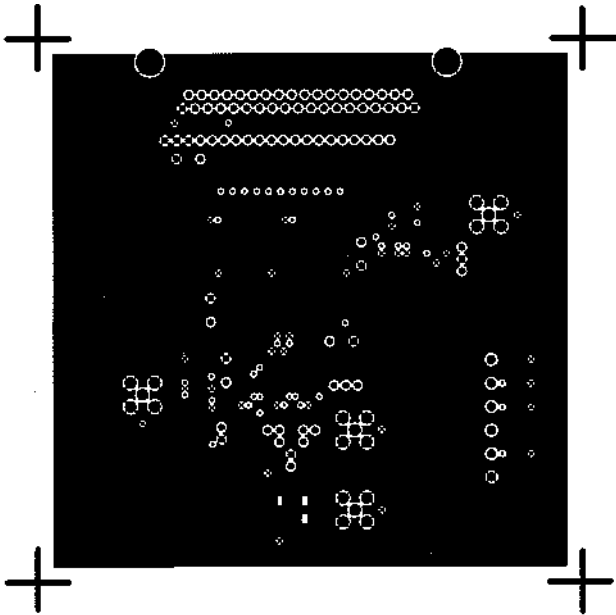

Figure 24. Printed Circuit Board Ground Layer

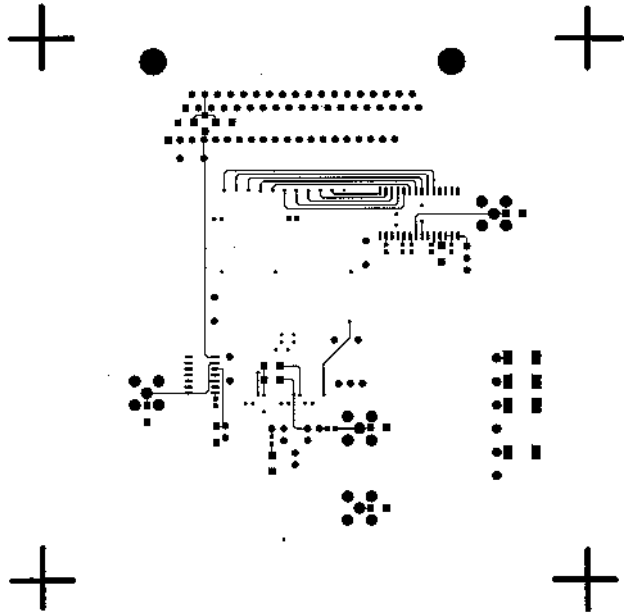

Figure 26. Printed Circuit Board Bottom Side Copper

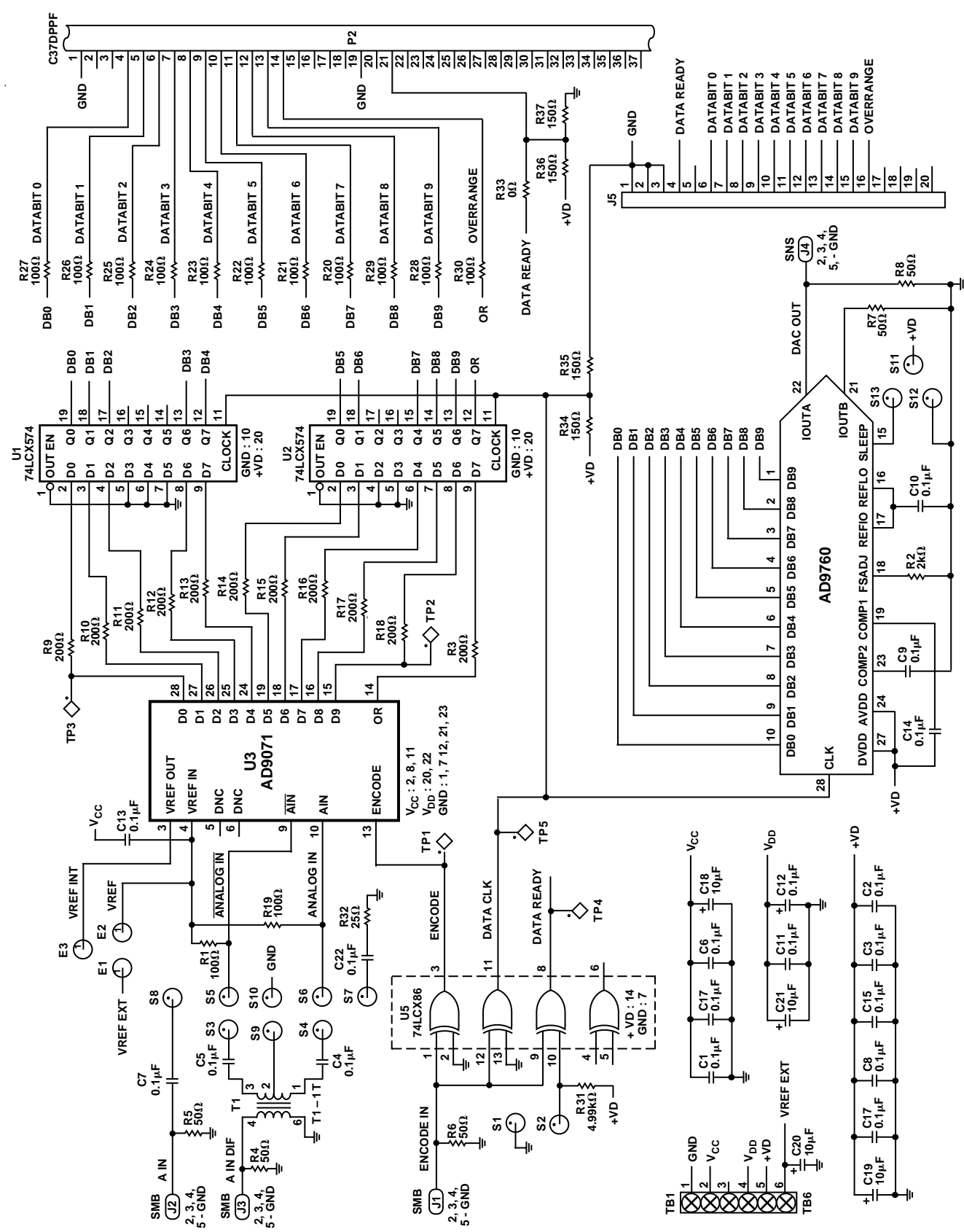

Figure 27. Printed Circuit Board Schematic

**Table II. Printed Circuit Board Bill of Materials**

| Item # | Quantity | Reference   | Description   |
|--------|----------|---|---|
| 1      | 18       | C1, C2, C3, C4, C5, C6, C7, C8, C9, C10, C11, C12, C13, C14, C15, C16, C17, C22 | Ceramic Chip Capacitor, 0603, 0.1 $\mu$ F                     |
| 2      | 4        | C18, C19, C20, C21  | Tantalum Chip Capacitor, 10 $\mu$ F                           |
| 3      | 3        | E1, E2, E3  | Jumpers   |
| 4      | 4        | J1, J2, J3, J4  | SMB-P Connector   |
| 5      | 1        | J5  | 20-Pin Male Header  |
| 6      | 1        | P2  | 37-Pin Connector (Amp 747462-4)                               |
| 7      | 13       | R1, R19, R20, R21, R22, R23, R24, R25, R26, R27, R28, R29, R30                  | Surface Mount Resistor, 1206, 100 $\Omega$                    |
| 8      | 1        | R2  | Surface Mount Resistor, 1206, 2000 $\Omega$                   |
| 9      | 11       | R3, R9, R10, R11, R12, R13, R14, R15, R16, R17, R18                             | Surface Mount Resistor, 1206, 200 $\Omega$                    |
| 10     | 5        | R4, R5, R6, R7, R8  | Surface Mount Resistor, 1206, 50 $\Omega$                     |
| 11     | 1        | R31   | Surface Mount Resistor, 1206, 5000 $\Omega$                   |
| 12     | 1        | R32   | Surface Mount Resistor, 1206, 25 $\Omega$                     |
| 13     | 1        | R33   | Surface Mount Resistor, 1206, 0 $\Omega$                      |
| 14     | 4        | R34, R35, R36, R37  | Surface Mount Resistor, 1206, 150 $\Omega$                    |
| 15     | 13       | S1, S2, S3, S4, S5, S6, S7, S8, S9, S10, S11, S12, S13                          | Jumpers   |
| 16     | 1        | T1  | Surface Mount Transformer Mini-Circuit T1-T1, 1:1 Ratio       |
| 17     | 1        | TB1   | 6-Pin Wieland Connector (P/N # 25,602, 2653.0; 25.530 3625.0) |
| 18     | 5        | TP1, TP2, TP3, TP4, TP5   | Test Points   |
| 19     | 2        | U1, U2  | 74LCX574 Octal Latch  |
| 20     | 1        | U3  | AD9071BR, 10-Bit, 100 MSPS, ADC                               |
| 21     | 1        | U4  | AD9760AR, 10-Bit, 125 MSPS, DAC                               |
| 22     | 1        | U5  | 74LCX86, XOR  |

C3331b-0-5/99

### OUTLINE DIMENSIONS

Dimensions shown in inches and (mm).

#### 28-Lead Wide Body SOIC (R-28)

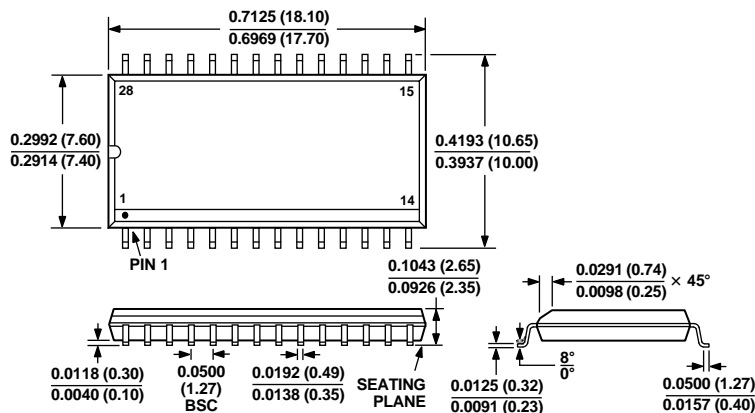

PRINTED IN U.S.A.