

FEATURES

- High common-mode voltage range**
4.5 V to 80 V operating
0 V to 85 V survival
- Buffered output voltage**
- Wide operating temperature range: -40°C to $+125^{\circ}\text{C}$**
- Excellent ac and dc performance**
 $\pm 100\text{ nV}/^{\circ}\text{C}$ typical offset drift
 $\pm 100\text{ }\mu\text{V}/^{\circ}\text{C}$ typical offset
 $\pm 5\text{ ppm}/^{\circ}\text{C}$ typical gain drift
100 dB typical CMRR at dc

APPLICATIONS

- High side current sensing**
48 V telecom
- Power management**
Base stations
- Unidirectional motor control**
- Precision high voltage current sources**

GENERAL DESCRIPTION

The AD8217 is a high voltage, high-resolution current shunt amplifier. It features a set gain of 20 V/V, with a maximum $\pm 0.35\%$ gain error over the entire temperature range. The buffered output voltage directly interfaces with any typical converter. The AD8217 offers excellent common-mode rejection from 4.5 V to 80 V, and includes an internal LDO, which directly powers the device from the high voltage rail. Therefore, no additional supply is necessary, provided that the input common-mode range is 4.5 V to 80 V. The AD8217 performs unidirectional current measurements across a shunt resistor in a variety of industrial and telecom applications including motor control, battery management, and base station power amplifier bias control.

FUNCTIONAL BLOCK DIAGRAM

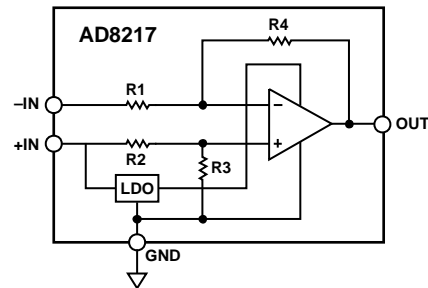

Figure 1.

08161-001

The AD8217 offers breakthrough performance throughout the -40°C to $+125^{\circ}\text{C}$ temperature range. It features a zero-drift core, which leads to a typical offset drift of $\pm 100\text{ nV}/^{\circ}\text{C}$ throughout the operating temperature and common-mode voltage range. Special attention is devoted to output linearity being maintained throughout the input differential voltage range of 0 mV to 250 mV, regardless of the common-mode voltage present, and the typical input offset voltage is $\pm 100\text{ }\mu\text{V}$.

The AD8217 is offered in a 8-lead MSOP package and is specified from -40°C to $+125^{\circ}\text{C}$.

Rev. 0

Information furnished by Analog Devices is believed to be accurate and reliable. However, no responsibility is assumed by Analog Devices for its use, nor for any infringements of patents or other rights of third parties that may result from its use. Specifications subject to change without notice. No license is granted by implication or otherwise under any patent or patent rights of Analog Devices. Trademarks and registered trademarks are the property of their respective owners.

TABLE OF CONTENTS

Features	1	Amplifier Core.....	10
Applications.....	1	Internal LDO.....	10
Functional Block Diagram	1	Application Notes.....	11
General Description	1	Output Linearity.....	11
Revision History	2	Applications Information	12
Specifications.....	3	High-Side Current Sensing.....	12
Absolute Maximum Ratings.....	4	Motor Control Current Sensing.....	12
ESD Caution.....	4	Outline Dimensions	13
Pin Configuration and Function Descriptions.....	5	Ordering Guide	13
Typical Performance Characteristics	6		
Theory of Operation	10		

REVISION HISTORY

7/10—Revision 0: Initial Version

SPECIFICATIONS

$T_{OPR} = -40^{\circ}\text{C}$ to $+125^{\circ}\text{C}$, $T_A = 25^{\circ}\text{C}$, $R_L = 25\text{ k}\Omega$, input common-mode voltage ($V_{CM} = 4.5\text{ V}$) (R_L is the output load resistor), unless otherwise noted.

Table 1.

Parameter	Min	Typ	Max	Unit	Test Conditions/Comments
GAIN					
Initial Accuracy		20		V/V	$V_O \geq 0.1\text{ V dc}$, T_A T_{OPR} T_{OPR}
Accuracy over Temperature		± 0.1	± 0.35	%	
Gain vs. Temperature		± 5		ppm/ $^{\circ}\text{C}$	
VOLTAGE OFFSET					
Offset Voltage (RTI) ¹			± 250	μV	25°C
Over Temperature (RTI) ¹			± 300	μV	T_{OPR}
Offset Drift		± 100		nV/ $^{\circ}\text{C}$	T_{OPR}
INPUT					
Bias Current ²		500	800	μA	T_A T_{OPR}
Common-Mode Input Voltage Range	4.5		80	V	Common-mode continuous
Differential Input Voltage Range ³		250		mV	Differential input voltage
Common-Mode Rejection (CMRR)	90	100		dB	T_{OPR}
OUTPUT					
Output Voltage Range Low	0.01			V	T_A ⁴
Output Voltage Range High			5	V	T_A ⁴
Output Impedance		2		Ω	
DYNAMIC RESPONSE					
Small Signal –3 dB Bandwidth		500		kHz	
Slew Rate		1		V/ μs	
NOISE					
0.1 Hz to 10 Hz, (RTI) ¹		2.3		$\mu\text{V p-p}$	
Spectral Density, 1 kHz, (RTI) ¹		110		nV/ $\sqrt{\text{Hz}}$	
POWER SUPPLY					
Operating Range	4.5		80	V	Power regulated from common mode
Quiescent Current Over Temperature			800	μA	Throughout input common mode
Power Supply Rejection Ratio (PSRR)	90	110		dB	T_{OPR}
TEMPERATURE RANGE					
For Specified Performance	-40		$+125$	$^{\circ}\text{C}$	

¹ RTI = referred to input.

² Refer to Figure 8 for further information on the input bias current. This current varies based on the input common-mode voltage. Additionally, the input bias current flowing to the +IN pin is also the supply current to the internal LDO.

³ The differential input voltage is specified as 250 mV typical because the output is internally clamped to 5 V. This ensures the output voltage does not exceed 5 V and can interface and not cause damage to any typical converter, regardless of the high voltage present at the inputs of the AD8217 (up to 80 V).

⁴ See Figure 17 and Figure 18 for further information on the output range of the AD8217 with various loads. The AD8217 output clamps to a maximum voltage of 5.6 V when the voltage at pin +IN is greater than 5.6 V. When the voltage at +IN is less than 5.6 V, the output reaches a maximum value of $(V_{+IN} - 100\text{ mV})$.

ABSOLUTE MAXIMUM RATINGS

Table 2.

Parameter	Rating
Maximum Input Voltage (+IN, -IN to GND)	0 V to 85 V
Differential Input Voltage (+IN to -IN)	± 1 V
HBM (Human Body Model) ESD Rating	± 2000 V
Operating Temperature Range (T _{OPR})	-40°C to +125°C
Storage Temperature Range	-65°C to +150°C
Output Short-Circuit Duration	Indefinite

Stresses above those listed under Absolute Maximum Ratings may cause permanent damage to the device. This is a stress rating only; functional operation of the device at these or any other conditions above those indicated in the operational section of this specification is not implied. Exposure to absolute maximum rating conditions for extended periods may affect device reliability.

ESD CAUTION



ESD (electrostatic discharge) sensitive device. Charged devices and circuit boards can discharge without detection. Although this product features patented or proprietary protection circuitry, damage may occur on devices subjected to high energy ESD. Therefore, proper ESD precautions should be taken to avoid performance degradation or loss of functionality.

PIN CONFIGURATION AND FUNCTION DESCRIPTIONS

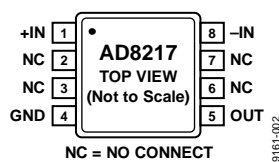

Figure 2. Pin Configuration

Table 3. Pin Function Descriptions

Pin No.	Mnemonic	Description
1	+IN	Noninverting Input. Supply pin to the internal LDO.
2	NC	No Connect. No internal connection to pin.
3	NC	No Connect. No internal connection to pin.
4	GND	Ground.
5	OUT	Output.
6	NC	No Connect. No internal connection to pin.
7	NC	No Connect. No internal connection to pin.
8	-IN	Inverting Input.

TYPICAL PERFORMANCE CHARACTERISTICS

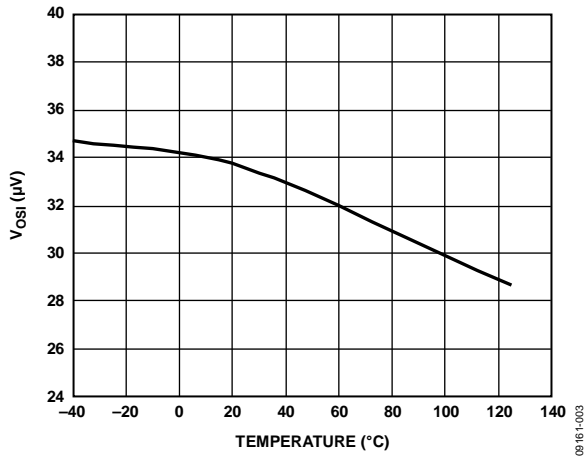

Figure 3. Typical Input Offset vs. Temperature

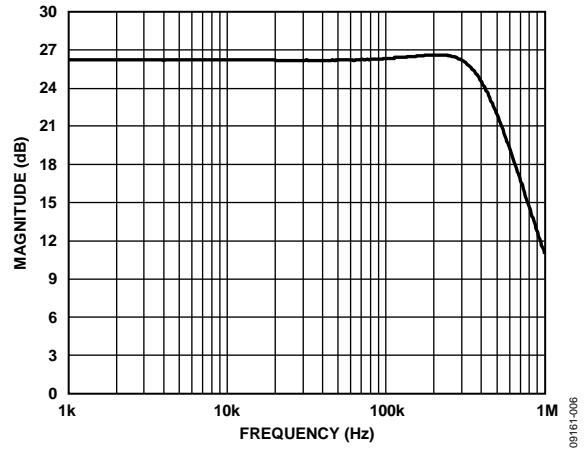

Figure 6. Typical Small-Signal Bandwidth ($V_{OUT} = 200\text{ mV p-p}$)

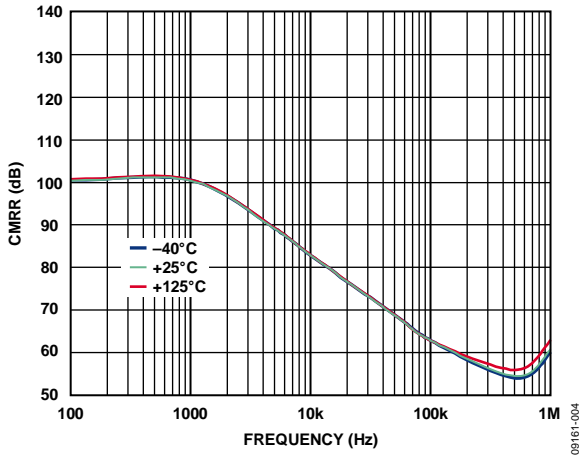

Figure 4. Typical CMRR vs. Frequency

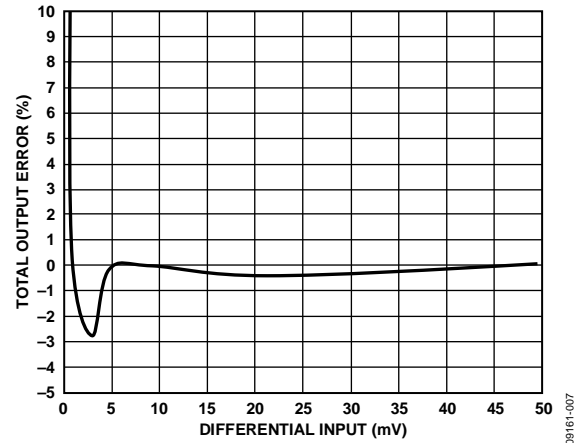

Figure 7. Total Output Error vs. Differential Input Voltage

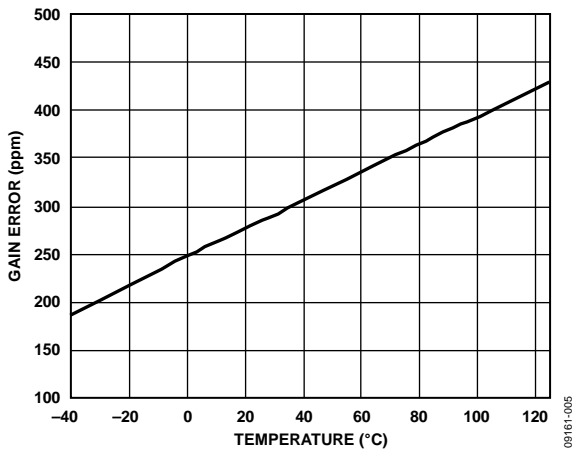

Figure 5. Typical Gain Error vs. Temperature

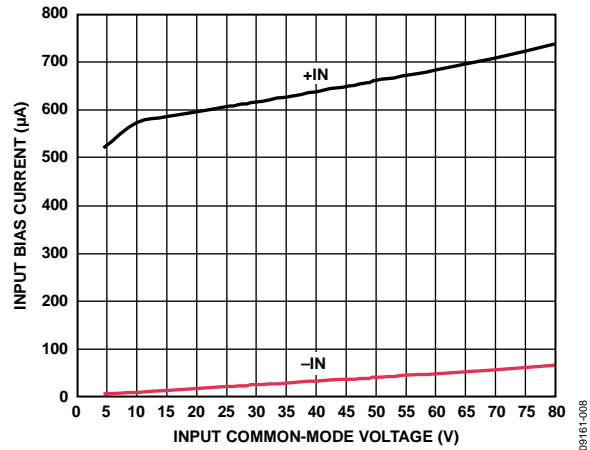

Figure 8. Input Bias Current vs. Input Common-Mode Voltage ($V_{DIFF} = 5\text{ mV}$)

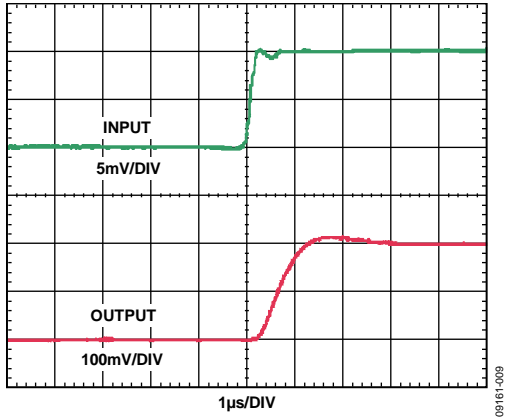

Figure 9. Rise Time (Differential Input = 5 mV)

09161-009

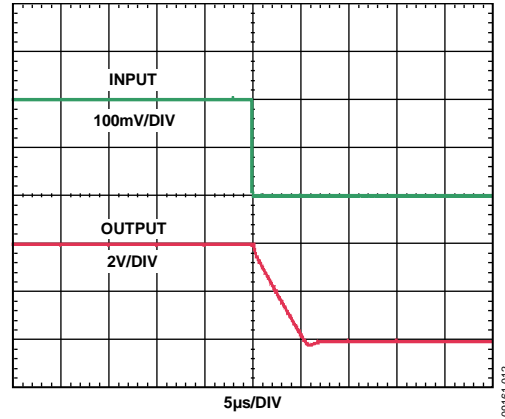

Figure 12. Fall Time (Differential Input = 200 mV)

09161-012

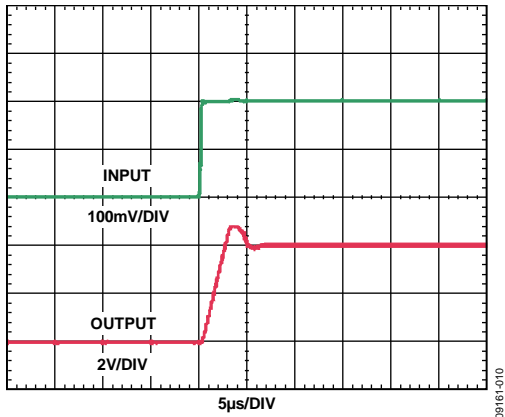

Figure 10. Rise Time (Differential Input = 200 mV)

09161-010

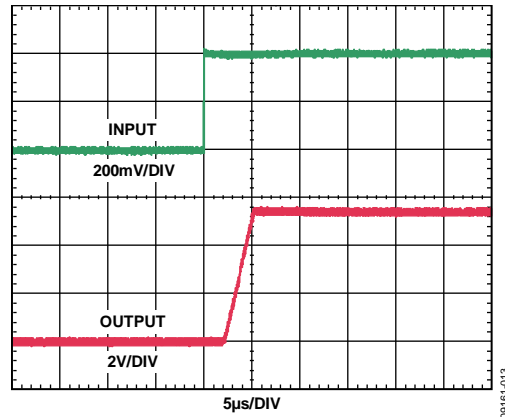

Figure 13. Differential Overload Recovery, Rising

09161-013

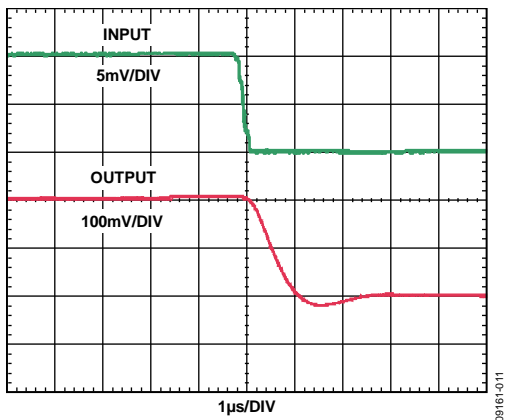

Figure 11. Fall Time (Differential Input = 5 mV)

09161-011

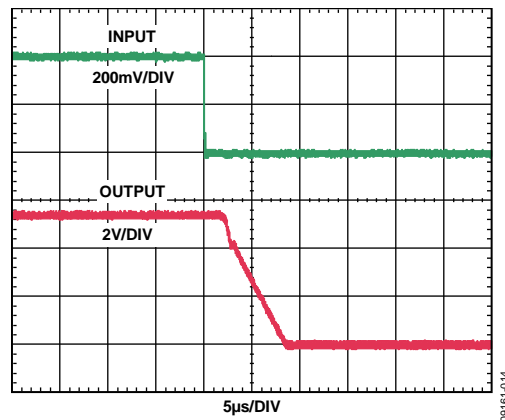

Figure 14. Differential Overload Recovery, Falling

09161-014

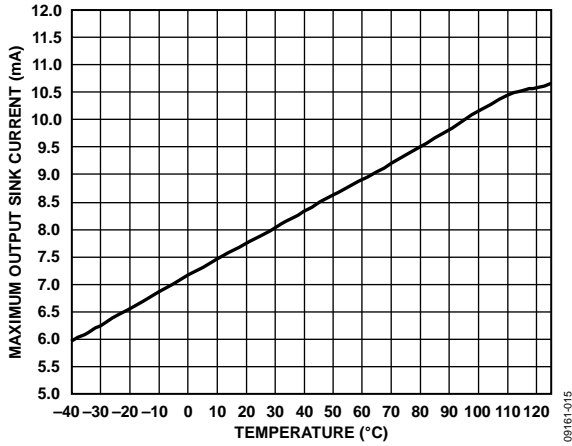

Figure 15. Maximum Output Sink Current vs. Temperature

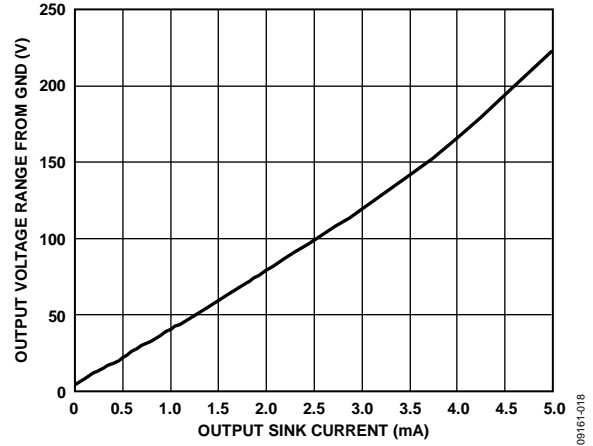

Figure 18. Output Voltage Range From GND vs. Output Sink Current

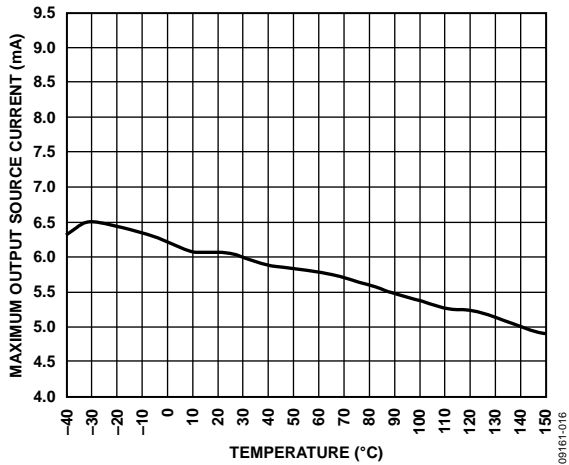

Figure 16. Maximum Output Source Current vs. Temperature

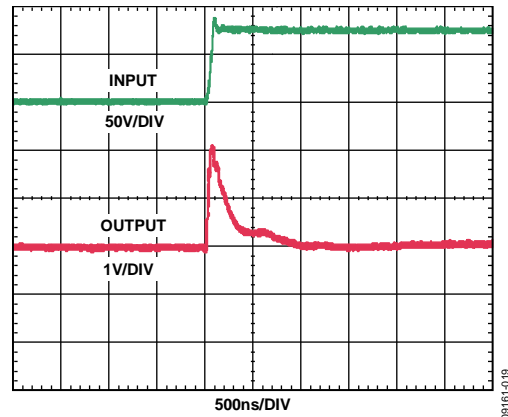

Figure 19. Common-Mode Step Response, Rising

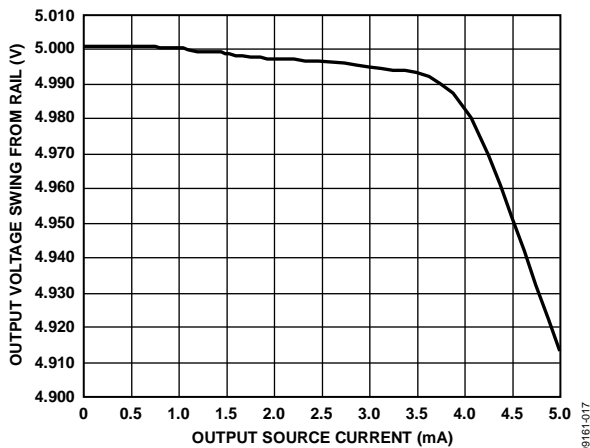

Figure 17. Output Voltage Range vs. Output Source Current

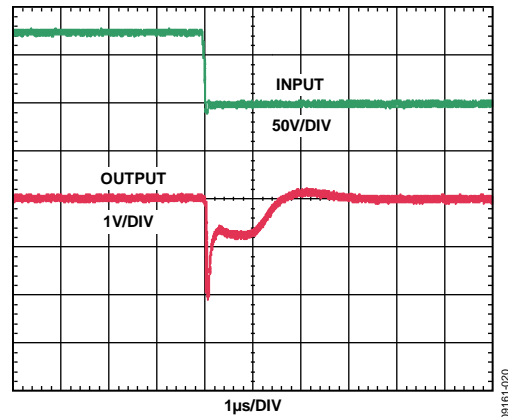

Figure 20. Common-Mode Step Response (Falling)

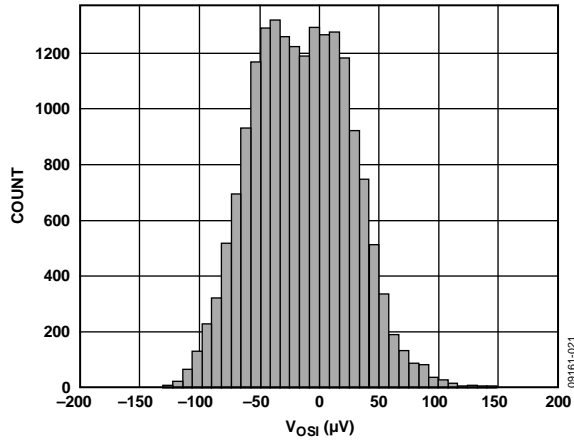

Figure 21. Input Offset Distribution

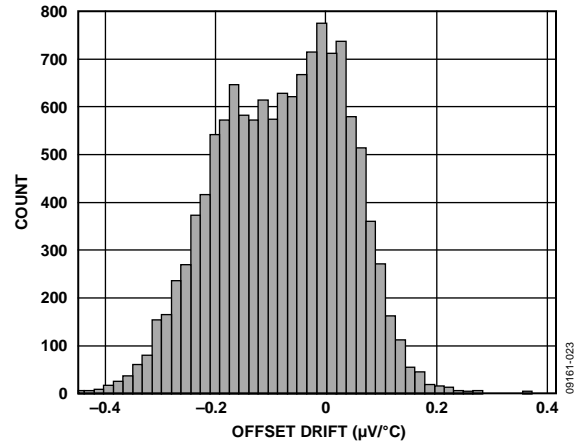

Figure 23. Input Offset Drift Distribution

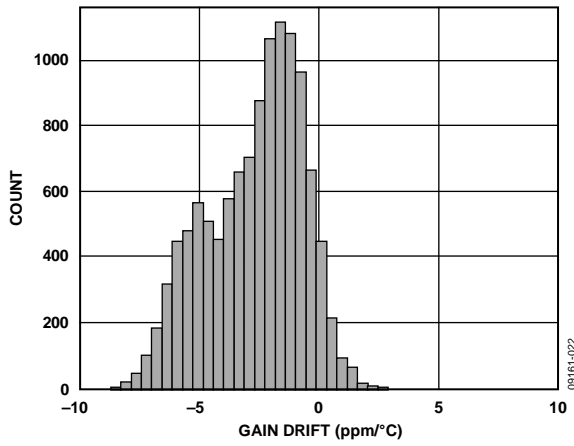

Figure 22. Gain Drift Distribution

THEORY OF OPERATION

AMPLIFIER CORE

In typical applications, the AD8217 amplifies a small differential input voltage generated by the load current flowing through a shunt resistor. The AD8217 rejects high common-mode voltages (up to 80 V) and provides a ground-referenced, buffered output that interfaces with an analog-to-digital converter (ADC). Figure 24 shows a simplified schematic of the AD8217.

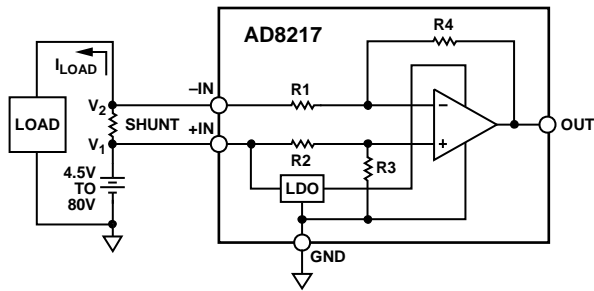

Figure 24. Simplified Schematic

The AD8217 is configured as a difference amplifier. The transfer function is

$$OUT = (R4/R1) \times (V1 - V2)$$

Resistors R4 and R1 are matched to within 0.01% and have values of 1.5 MΩ and 75 kΩ, respectively, meaning an input to output total gain of 20 V/V for the AD8217.

The AD8217 accurately amplifies the input differential signal, rejecting high voltage common modes ranging from 4.5 V to 80 V.

The main amplifier uses a novel zero-drift architecture, providing the end user with an extremely stable part over temperature. The offset drift is typically less than ± 100 nV/°C. This performance leads to optimal accuracy and dynamic range.

INTERNAL LDO

The AD8217 includes an internal LDO, which allows the device to power directly from the common-mode voltage at the inputs. No additional standalone supply is necessary, provided that the common-mode voltage at the +IN pin is at least 4.5 V and up to 80 V. Once the common-mode voltage is above 5.6 V, the LDO output reaches its maximum value, that is 5.6 V. This is also the maximum output voltage range of the AD8217. Because the AD8217 output typically interfaces with a converter, the 5.6 V maximum output range ensures the ADC input is not damaged due to excessive overvoltage.

The input bias current flowing through Pin +IN powers the internal LDO and, therefore, doubles as the supply current for the AD8217. This current varies depending on the input common-mode voltage. See Figure 8 for additional information.

APPLICATION NOTES

OUTPUT LINEARITY

In all current sensing applications where the common-mode voltage can vary significantly, it is important that the current sensor maintain the specified output linearity, regardless of the input differential or common-mode voltage. The AD8217 maintains a very high input-to-output linearity even when the differential input voltage is very small.

Regardless of the common mode, the AD8217 provides a correct output voltage when the input differential is at least 1 mV. The ability of the AD8217 to work with very small differential inputs, regardless of the common-mode voltage, allows for optimal dynamic range, accuracy, and flexibility in any current sensing application.

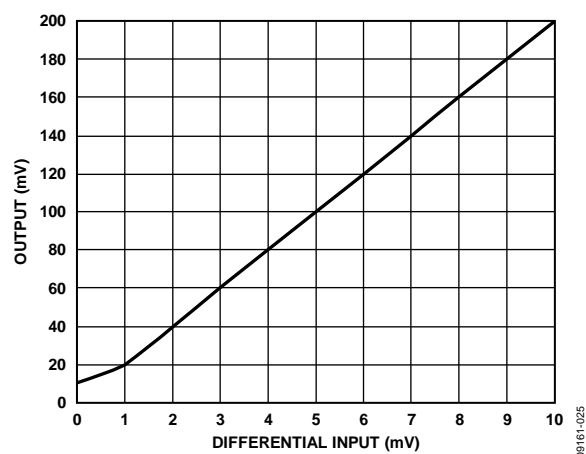

Figure 25. Gain Linearity at Small Differential Inputs ($V_{CM} = 4.5\text{ V to }80\text{ V}$)

APPLICATIONS INFORMATION

HIGH-SIDE CURRENT SENSING

In this configuration, the shunt resistor is referenced to the battery (see Figure 26). High voltage is present at the inputs of the current sense amplifier. When the shunt is battery referenced, the AD8217 produces a linear ground-referenced analog output. The AD8217 includes an internal LDO, which allows the part to be powered from the high voltage rail, with no need for an additional standalone supply.

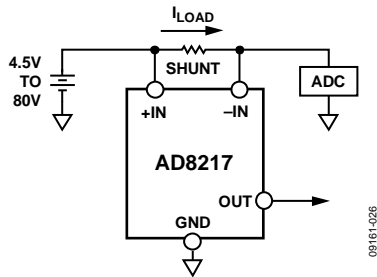

Figure 26. Battery-Referenced Shunt Resistor

MOTOR CONTROL CURRENT SENSING

The AD8217 is a practical, accurate solution for high-side current sensing in motor control applications. In cases where the shunt resistor is referenced to battery and the current flowing is unidirectional (as shown in Figure 27), the AD8217 monitors the current with no additional supply pin necessary.

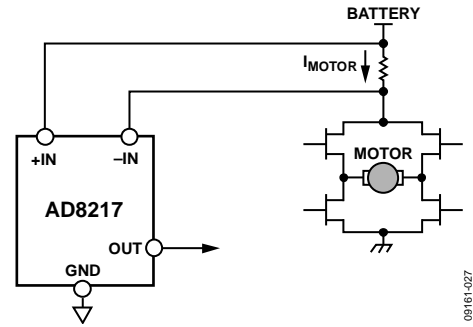
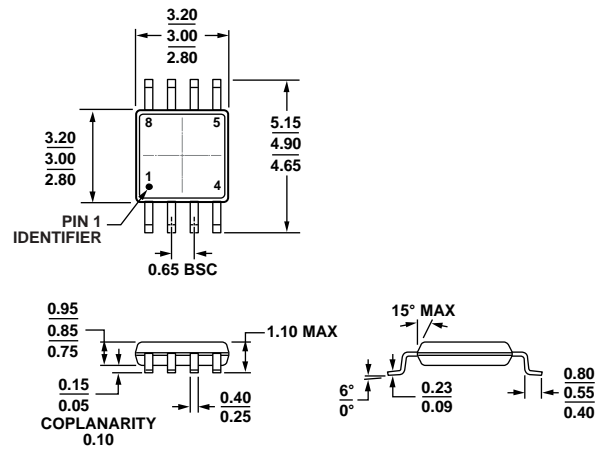

Figure 27. High-Side Current Sensing in Motor Control

OUTLINE DIMENSIONS



COMPLIANT TO JEDEC STANDARDS MO-187-AA

Figure 28. 8-Lead Mini Small Outline Package [MSOP] (RM-8)

Dimensions shown in millimeters

1000705-B

ORDERING GUIDE

Model ¹	Temperature Range	Package Description	Package Option	Branding
AD8217BRMZ	-40°C to +125°C	8-Lead Mini Small Outline Package (MSOP)	RM-8	Y2L
AD8217BRMZ-RL	-40°C to +125°C	8-Lead Mini Small Outline Package (MSOP)	RM-8	Y2L
AD8217BRMZ-R7	-40°C to +125°C	8-Lead Mini Small Outline Package (MSOP)	RM-8	Y2L

¹ Z = RoHS Compliant Part.

AD8217

NOTES

NOTES

AD8217

NOTES