

FEATURES

Low Cost Single (AD8057) and Dual (AD8058)

High Speed

325 MHz -3 dB Bandwidth ($G = +1$)

1000 V/ μ s Slew Rate

Gain Flatness 0.1 dB to 28 MHz

Low Noise

7 nV/ $\sqrt{\text{Hz}}$

Low Power

5.4 mA/Amplifier Typical Supply Current @ 5 V

Low Distortion

-85 dBc @ 5 MHz, $R_L = 1$ k Ω

Wide Supply Range from 3 V to 12 V

Small Packaging

AD8057 Available in SOIC-8 and SOT-23-5

AD8058 Available in SOIC-8 and MSOP

APPLICATIONS

Imaging

DVD/CD

Photodiode Preamp

A-to-D Driver

Professional Cameras

Filters

GENERAL DESCRIPTION

The AD8057 (single) and AD8058 (dual) are very high performance amplifiers with a very low cost. The balance between cost and performance make them ideal for many applications. The AD8057 and AD8058 will reduce the need to qualify a variety of specialty amplifiers.

The AD8057 and AD8058 are voltage feedback amplifiers with the bandwidth and slew rate normally found in current feedback amplifiers. The AD8057 and AD8058 are low power amplifiers having low quiescent current and a wide supply range from 3 V to 12 V. They have noise and distortion performance required for high end video systems as well as dc performance parameters rarely found in high speed amplifiers.

The AD8057 and AD8058 are available in standard SOIC packaging as well as tiny SOT-23-5 (AD8057) and MSOP (AD8058) packages. These amplifiers are available in the industrial temperature range of -40°C to $+85^\circ\text{C}$.

CONNECTION DIAGRAMS (TOP VIEW)

RT-5 (SOT-23-5)

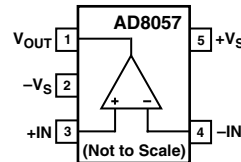

R-8 (SOIC)

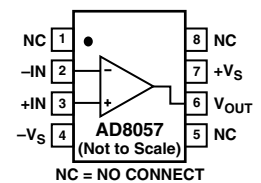

RM-8 (MSOP)

R-8 (SOIC)

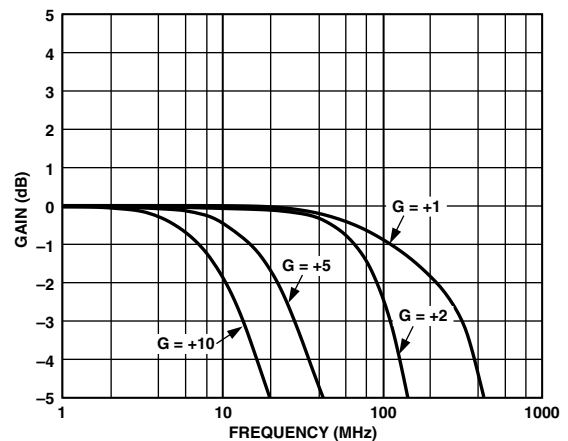
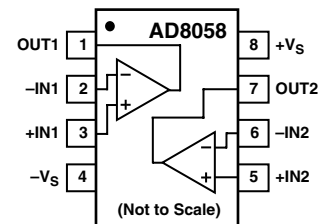

Figure 1. Small Signal Frequency Response

REV. B

Information furnished by Analog Devices is believed to be accurate and reliable. However, no responsibility is assumed by Analog Devices for its use, nor for any infringements of patents or other rights of third parties that may result from its use. No license is granted by implication or otherwise under any patent or patent rights of Analog Devices. Trademarks and registered trademarks are the property of their respective owners.

AD8057/AD8058—SPECIFICATIONS

(@ $T_A = 25^\circ\text{C}$, $V_S = \pm 5\text{ V}$, $R_L = 100\ \Omega$, $R_F = 0\ \Omega$, $\text{Gain} = +1$, unless otherwise noted.)

Parameter	Conditions	AD8057/AD8058			Unit
		Min	Typ	Max	
DYNAMIC PERFORMANCE					
-3 dB Bandwidth	$G = +1$, $V_O = 0.2\text{ V p-p}$		325		MHz
	$G = -1$, $V_O = 0.2\text{ V p-p}$		95		MHz
	$G = +1$, $V_O = 2\text{ V p-p}$		175		MHz
Bandwidth for 0.1 dB Flatness	$G = +1$, $V_O = 0.2\text{ V p-p}$		30		MHz
Slew Rate	$G = +1$, $V_O = 2\text{ V Step}$, $R_L = 2\text{ k}\Omega$		850		V/ μs
	$G = +1$, $V_O = 4\text{ V Step}$, $R_L = 2\text{ k}\Omega$		1150		V/ μs
Settling Time to 0.1%	$G = +2$, $V_O = 2\text{ V Step}$		30		ns
NOISE/HARMONIC PERFORMANCE					
Total Harmonic Distortion	$f_C = 5\text{ MHz}$, $V_O = 2\text{ V p-p}$, $R_L = 1\text{ k}\Omega$		-85		dBc
	$f_C = 20\text{ MHz}$, $V_O = 2\text{ V p-p}$, $R_L = 1\text{ k}\Omega$		-62		dBc
SFDR	$f = 5\text{ MHz}$, $V_O = 2\text{ V p-p}$, $R_L = 150\ \Omega$		-68		dB
Third Order Intercept	$f = 5\text{ MHz}$, $V_O = 2\text{ V p-p}$		-35		dBm
Crosstalk, Output to Output	$f = 5\text{ MHz}$, $G = +2$		-60		dB
Input Voltage Noise	$f = 100\text{ kHz}$		7		nV/ $\sqrt{\text{Hz}}$
Input Current Noise	$f = 100\text{ kHz}$		0.7		pA/ $\sqrt{\text{Hz}}$
Differential Gain Error	NTSC, $G = +2$, $R_L = 150\ \Omega$		0.01		%
	NTSC, $G = +2$, $R_L = 1\text{ k}\Omega$		0.02		%
Differential Phase Error	NTSC, $G = +2$, $R_L = 150\ \Omega$		0.15		Degree
	NTSC, $G = +2$, $R_L = 1\text{ k}\Omega$		0.01		Degree
Overload Recovery	$V_{IN} = 200\text{ mV p-p}$, $G = +1$		30		ns
DC PERFORMANCE					
Input Offset Voltage			1	5	mV
	T_{MIN} to T_{MAX}		2.5		mV
Input Offset Voltage Drift			3		$\mu\text{V}/^\circ\text{C}$
Input Bias Current			0.5	2.5	μA
	T_{MIN} to T_{MAX}		3.0		μA
Input Offset Current				± 0.75	μA
Open-Loop Gain	$V_O = \pm 2.5\text{ V}$, $R_L = 2\text{ k}\Omega$	50	55		dB
	$V_O = \pm 2.5\text{ V}$, $R_L = 150\ \Omega$	50	52		dB
INPUT CHARACTERISTICS					
Input Resistance			10		M Ω
Input Capacitance	+Input		2		pF
Input Common-Mode Voltage Range	$R_L = 1\text{ k}\Omega$	-4.0		+4.0	V
Common-Mode Rejection Ratio	$V_{CM} = \pm 2.5\text{ V}$	48	60		dB
OUTPUT CHARACTERISTICS					
Output Voltage Swing	$R_L = 2\text{ k}\Omega$	-4.0		+4.0	V
	$R_L = 150\ \Omega$		± 3.9		V
Capacitive Load Drive	30% Overshoot		30		pF
POWER SUPPLY					
Operating Range			± 5.0		V
Quiescent Current for AD8057			6.0	7.5	mA
Quiescent Current for AD8058			14.0	15	mA
Power Supply Rejection Ratio	$V_S = \pm 5\text{ V}$ to $\pm 1.5\text{ V}$	54	59		dB

Specifications subject to change without notice.

SPECIFICATIONS

(@ $T_A = 25^\circ\text{C}$, $V_S = 5\text{ V}$, $R_L = 100\ \Omega$, $R_F = 0\ \Omega$, Gain = +1, unless otherwise noted.)

Parameter	Conditions	AD8057/AD8058			Unit	
		Min	Typ	Max		
DYNAMIC PERFORMANCE						
-3 dB Bandwidth	$G = +1$, $V_O = 0.2\text{ V p-p}$		300		MHz	
	$G = +1$, $V_O = 2\text{ V p-p}$		155		MHz	
Bandwidth for 0.1 dB Flatness	$V_O = 0.2\text{ V p-p}$		28		MHz	
Slew Rate	$G = +1$, $V_O = 2\text{ V Step}$, $R_L = 2\text{ k}\Omega$		700		V/ μs	
Settling Time to 0.1%	$G = +2$, $V_O = 2\text{ V Step}$		35		ns	
NOISE/HARMONIC PERFORMANCE						
Total Harmonic Distortion	$f_C = 5\text{ MHz}$, $V_O = 2\text{ V p-p}$, $R_L = 1\text{ k}\Omega$		-75		dBc	
	$f_C = 20\text{ MHz}$, $V_O = 2\text{ V p-p}$, $R_L = 1\text{ k}\Omega$		-54		dBc	
Crosstalk, Output to Output	$f = 5\text{ MHz}$, $G = +2$		-60		dB	
Input Voltage Noise	$f = 100\text{ kHz}$		7		nV/ $\sqrt{\text{Hz}}$	
Input Current Noise	$f = 100\text{ kHz}$		0.7		pA/ $\sqrt{\text{Hz}}$	
Differential Gain Error	NTSC, $G = +2$, $R_L = 150\ \Omega$		0.05		%	
	NTSC, $G = +2$, $R_L = 1\text{ k}\Omega$		0.05		%	
Differential Phase Error	NTSC, $G = +2$, $R_L = 150\ \Omega$		0.10		Degree	
	NTSC, $G = +2$, $R_L = 1\text{ k}\Omega$		0.02		Degree	
DC PERFORMANCE						
Input Offset Voltage	T_{MIN} to T_{MAX}		1	5	mV	
				2.5		mV
Input Offset Voltage Drift	T_{MIN} to T_{MAX}		3		$\mu\text{V}/^\circ\text{C}$	
Input Bias Current			0.5	2.5	μA	
				3.0		μA
Input Offset Current					0.75	μA
Open-Loop Gain	$V_O = \pm 1.25\text{ V}$, $R_L = 2\text{ k}\Omega$ to Midsupply	50	55		dB	
	$V_O = \pm 1.25\text{ V}$, $R_L = 150\ \Omega$ to Midsupply	45	52		dB	
INPUT CHARACTERISTICS						
Input Resistance	+Input $R_L = 1\text{ k}\Omega$ $V_{\text{CM}} = \pm 2.5\text{ V}$		10		M Ω	
Input Capacitance			2		pF	
Input Common-Mode Voltage Range				± 0.9 to ± 3.4		V
Common-Mode Rejection Ratio			48	60		dB
OUTPUT CHARACTERISTICS						
Output Voltage Swing	$R_L = 2\text{ k}\Omega$		0.9 to 4.1		V	
	$R_L = 150\ \Omega$		1.2 to 3.8		V	
Capacitive Load Drive	30% Overshoot		30		pF	
POWER SUPPLY						
Operating Range			5.0		V	
Quiescent Current for AD8057			5.4	7.0	mA	
Quiescent Current for AD8058			13.5	14	mA	
Power Supply Rejection Ratio		54	58		dB	

Specifications subject to change without notice.

AD8057/AD8058

ABSOLUTE MAXIMUM RATINGS¹

Supply Voltage (+V _S to -V _S)	12.6 V
Internal Power Dissipation ²	
SOIC Package (R)	0.8 W
SOT-23-5 Package (RT)	0.5 W
MSOP Package (RM)	0.6 W
Input Voltage (Common Mode)	±V _S
Differential Input Voltage	±4.0 V
Output Short Circuit Duration	Observe Power Derating Curves
Storage Temperature Range (R)	-65°C to +125°C
Operating Temperature Range (A Grade)	-40°C to +85°C
Lead Temperature Range (Soldering 10 sec)	300°C

NOTES

¹Stresses above those listed under Absolute Maximum Ratings may cause permanent damage to the device. This is a stress rating only; functional operation of the device at these or any other conditions above those indicated in the operational section of this specification is not implied. Exposure to absolute maximum rating conditions for extended periods may affect device reliability.

²Specification is for device in free air:
 8-Lead SOIC Package: $\theta_{JA} = 160^{\circ}\text{C}/\text{W}$
 5-Lead SOT-23-5 Package: $\theta_{JA} = 240^{\circ}\text{C}/\text{W}$
 8-Lead MSOP Package: $\theta_{JA} = 200^{\circ}\text{C}/\text{W}$

MAXIMUM POWER DISSIPATION

The maximum power that can be safely dissipated by the AD8057/AD8058 is limited by the associated rise in junction temperature. Exceeding a junction temperature of 175°C for an extended period can result in device failure. While the AD8057/AD8058 is internally short-circuit protected, this may not be sufficient to guarantee that the maximum junction temperature (150°C) is not exceeded under all conditions.

To ensure proper operation, it is necessary to observe the maximum power derating curves.

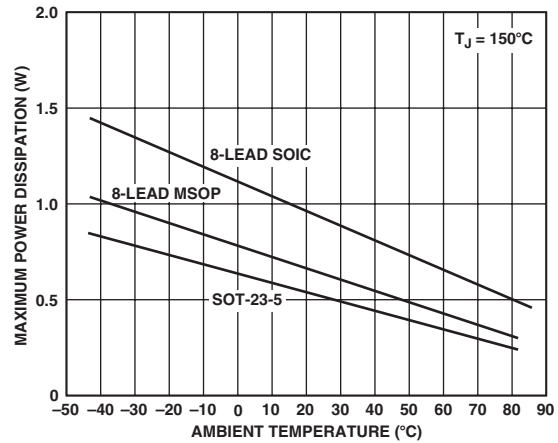

Figure 2. Plot of Maximum Power Dissipation vs. Temperature

ORDERING GUIDE

Model	Temperature Range	Package Description	Package Option	Branding
AD8057AR	-40°C to +85°C	8-Lead Narrow Body SOIC Die	R-8 Waffle Pak	Standard N/A
AD8057ACHIPS	-40°C to +85°C	8-Lead SOIC, 13" Reel	R-8	Standard
AD8057AR-REEL	-40°C to +85°C	8-Lead SOIC, 7" Reel	R-8	Standard
AD8057AR-REEL7	-40°C to +85°C	5-Lead SOT-23	RT-5	H7A
AD8057ART-R2	-40°C to +85°C	5-Lead SOT-23, 13" Reel	RT-5	H7A
AD8057ART-REEL	-40°C to +85°C	5-Lead SOT-23, 7" Reel	RT-5	H7A
AD8057ART-REEL7	-40°C to +85°C	5-Lead SOT-23, 7" Reel	RT-5	H7A
AD8057ARTZ-REEL7*	-40°C to +85°C	8-Lead Narrow Body SOIC Die	R-8 Waffle Pak	Standard N/A
AD8058AR	-40°C to +85°C	8-Lead SOIC, 13" Reel	R-8	Standard
AD8058ACHIPS	-40°C to +85°C	8-Lead SOIC, 7" Reel	R-8	Standard
AD8058AR-REEL	-40°C to +85°C	8-Lead SOIC, 7" Reel	R-8	Standard
AD8058AR-REEL7	-40°C to +85°C	8-Lead MSOP	RM-8	H8A
AD8058ARZ-REEL7*	-40°C to +85°C	8-Lead MSOP, 13" Reel	RM-8	H8A
AD8058ARM	-40°C to +85°C	8-Lead MSOP, 7" Reel	RM-8	H8A
AD8058ARM-REEL	-40°C to +85°C	8-Lead MSOP, 7" Reel	RM-8	H8A
AD8058ARM-REEL7	-40°C to +85°C	8-Lead MSOP, 7" Reel	RM-8	H8A
AD8058ARMZ-REEL7*	-40°C to +85°C	8-Lead MSOP, 7" Reel	RM-8	H8A

*Lead free

CAUTION

ESD (electrostatic discharge) sensitive device. Electrostatic charges as high as 4000 V readily accumulate on the human body and test equipment and can discharge without detection. Although the AD8057/AD8058 features proprietary ESD protection circuitry, permanent damage may occur on devices subjected to high energy electrostatic discharges. Therefore, proper ESD precautions are recommended to avoid performance degradation or loss of functionality.



Typical Performance Characteristics—AD8057/AD8058

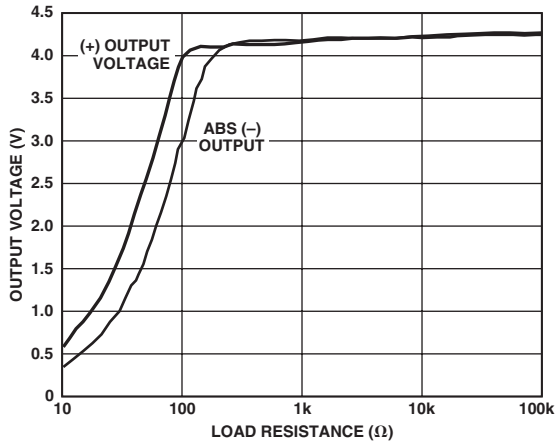

TPC 1. Output Swing vs. Load Resistance

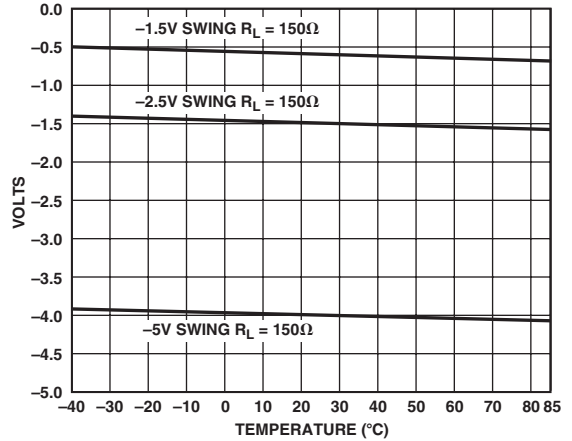

TPC 4. Negative Output Voltage Swing vs. Temperature

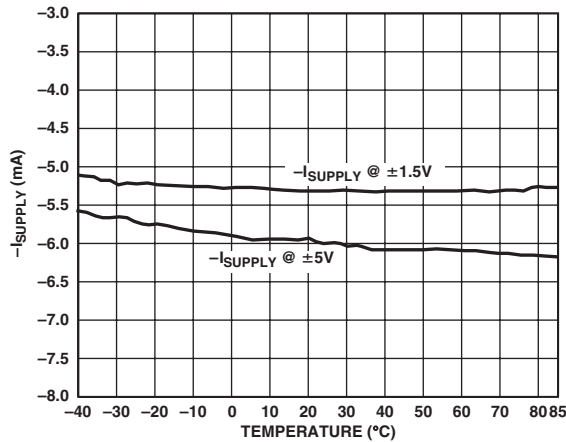

TPC 2. $-I_{SUPPLY}$ vs. Temperature

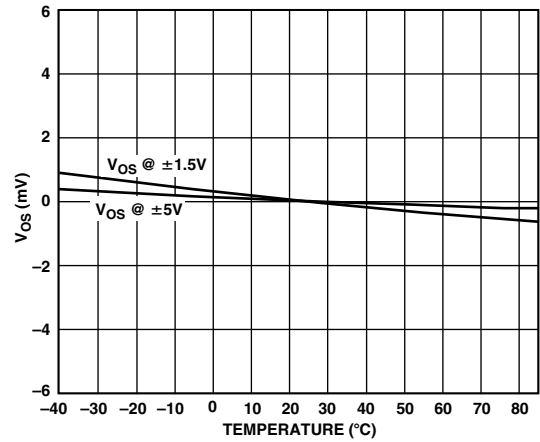

TPC 5. V_{OS} vs. Temperature

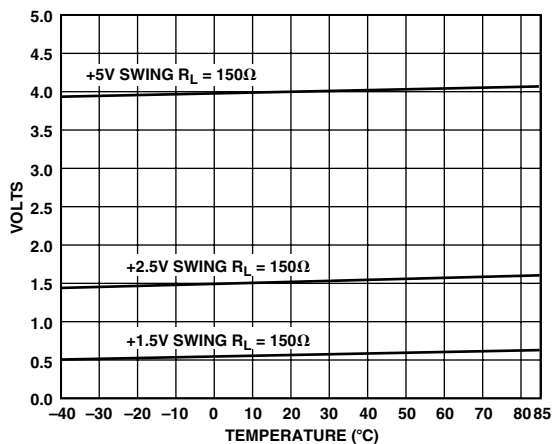

TPC 3. Positive Output Voltage Swing vs. Temperature

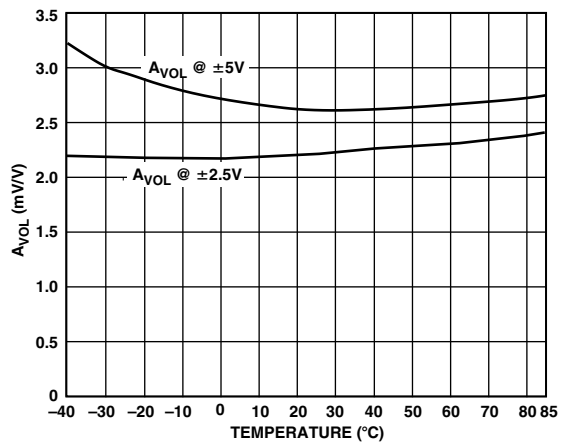

TPC 6. Open-Loop Gain vs. Temperature

AD8057/AD8058

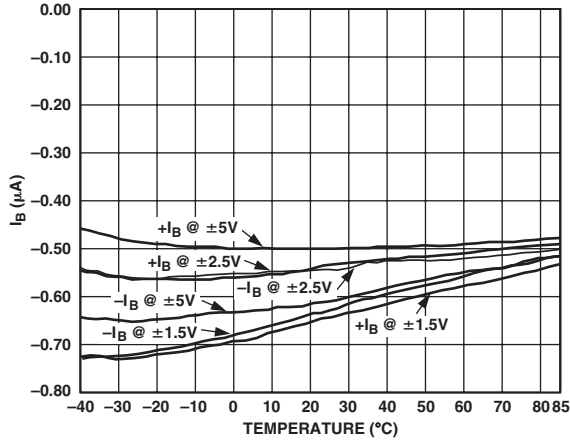

TPC 7. Input Bias Current vs. Temperature

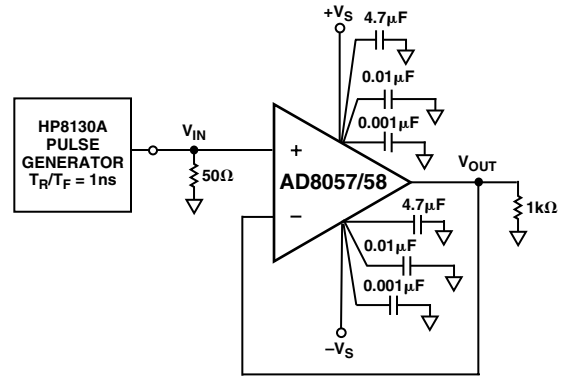

TPC 10. Test Circuit $G = +1$, $R_L = 1\ \text{k}\Omega$ for TPCs 11 and 12

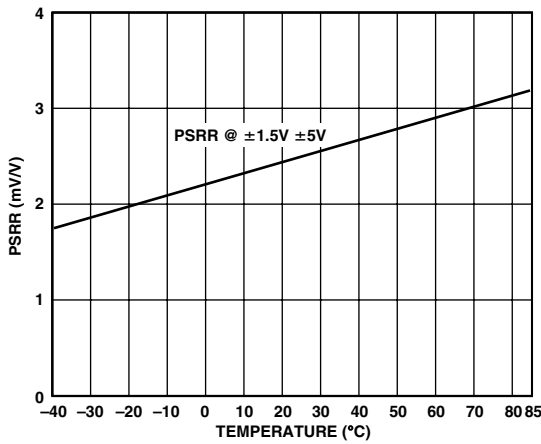

TPC 8. PSRR vs. Temperature

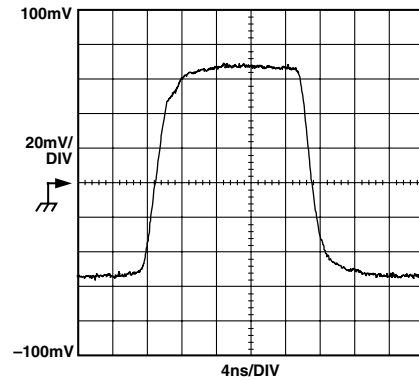

TPC 11. Small Signal Step Response $G = +1$, $R_L = 1\ \text{k}\Omega$, $V_S = \pm 5\ \text{V}$

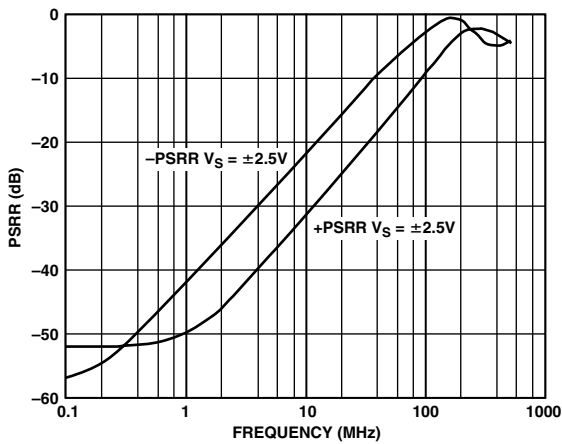

TPC 9. $\pm\text{PSRR}$ vs. Frequency

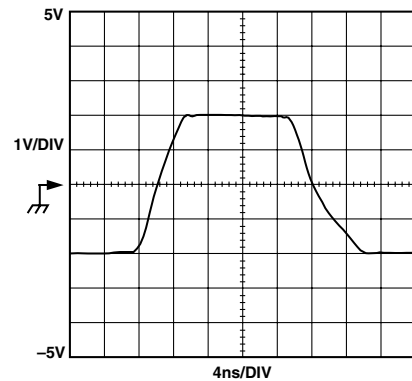

TPC 12. Large Signal Step Response $G = +1$, $R_L = 1\ \text{k}\Omega$, $V_S = \pm 5.0\ \text{V}$

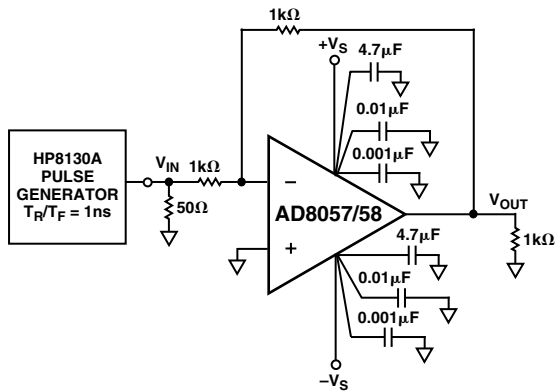

TPC 13. Test Circuit $G = -1$, $R_L = 1\text{ k}\Omega$ for TPCs 14 and 15

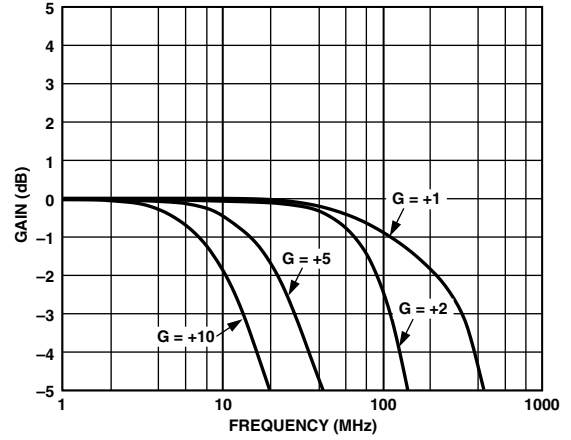

TPC 16. Small Signal Frequency Response, $V_{OUT} = 0.2\text{ V p-p}$

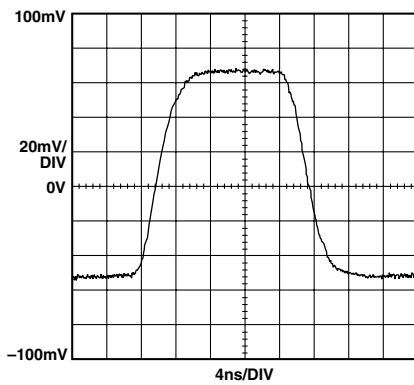

TPC 14. Small Signal Step Response $G = -1$, $R_L = 1\text{ k}\Omega$

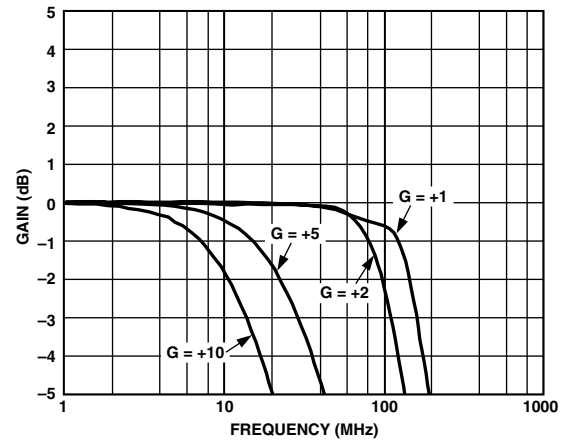

TPC 17. Large Signal Frequency Response, $V_{OUT} = 2\text{ V p-p}$

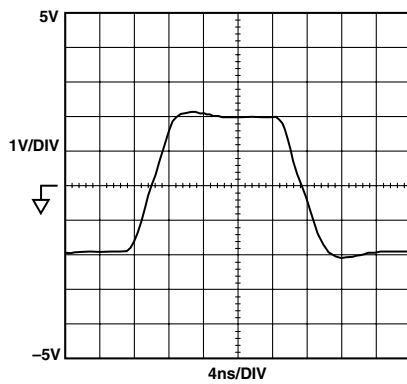

TPC 15. Large Signal Step Response $G = -1$, $R_L = 1\text{ k}\Omega$

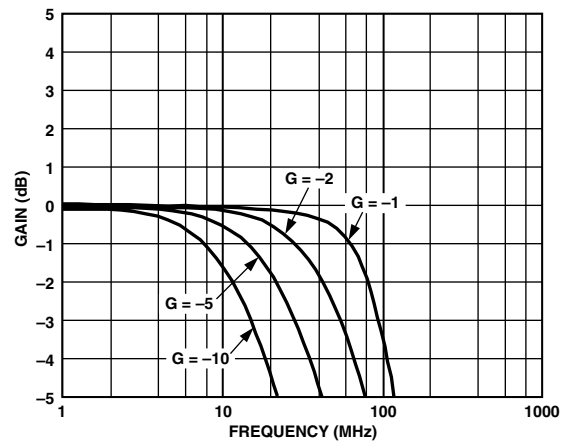

TPC 18. Large Signal Frequency Response

AD8057/AD8058

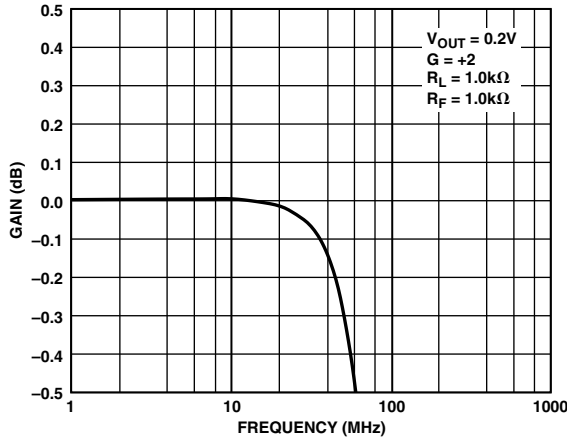

TPC 19. 0.1 dB Flatness $G = +2$

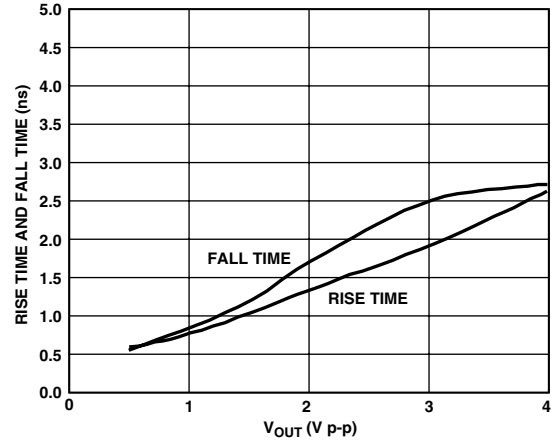

TPC 22. Rise Time and Fall Time vs. V_{OUT} , $G = +1$, $R_L = 1\text{ k}\Omega$, $R_F = 0\ \Omega$

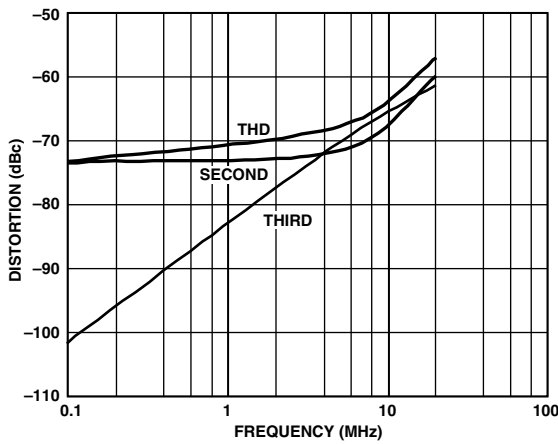

TPC 20. Distortion vs. Frequency, $R_L = 150\ \Omega$

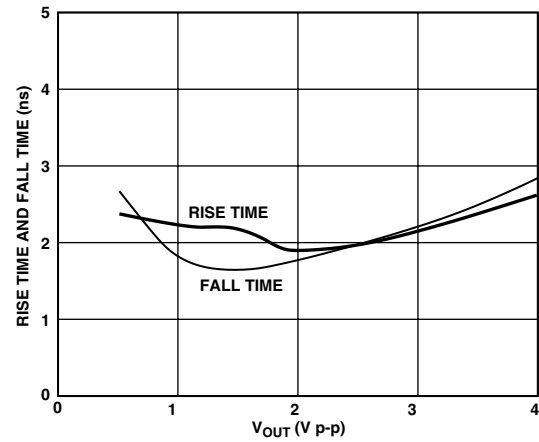

TPC 23. Rise Time and Fall Time vs. V_{OUT} , $G = +2$, $R_L = 100\ \Omega$, $R_F = 402\ \Omega$

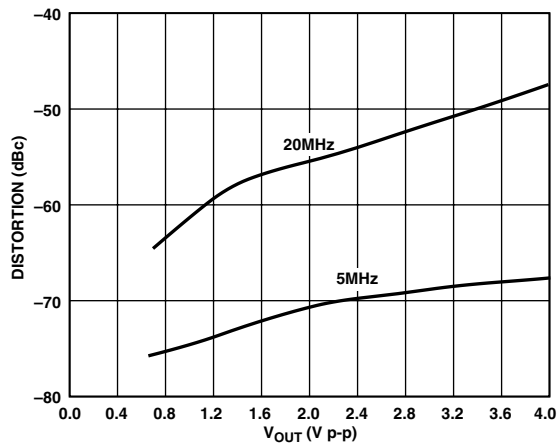

TPC 21. Distortion vs. V_{OUT} @ 20 MHz, 5 MHz, $R_L = 150\ \Omega$, $V_S = \pm 5.0\text{ V}$

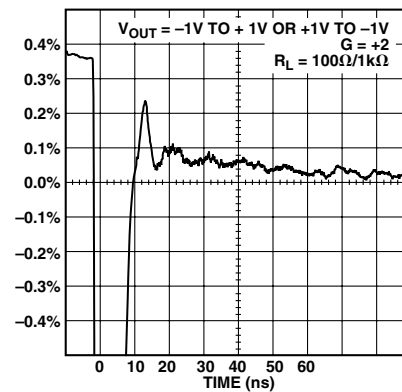

TPC 24. Settling Time

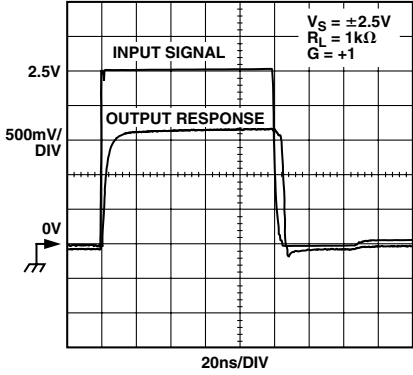

TPC 25. Input Overload Recovery, $V_S = \pm 2.5\text{ V}$

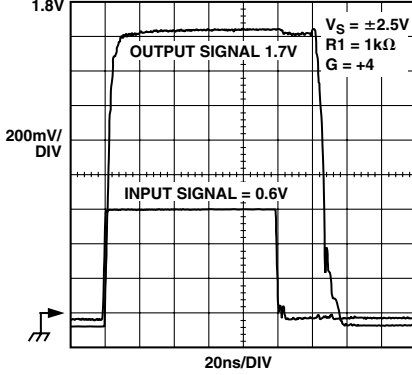

TPC 28. Output Overload Recovery, $V_S = \pm 2.5\text{ V}$

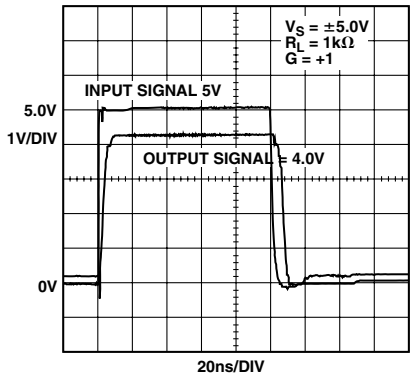

TPC 26. Output Overload Recovery, $V_S = \pm 5.0\text{ V}$

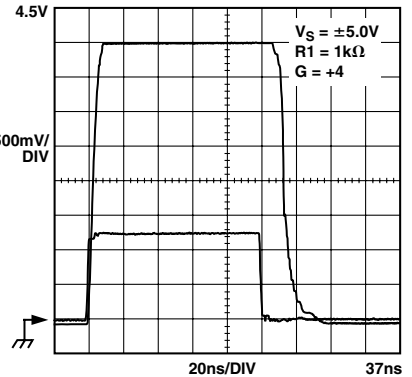

TPC 29. Output Overload Recovery, $V_S = \pm 5.0\text{ V}$

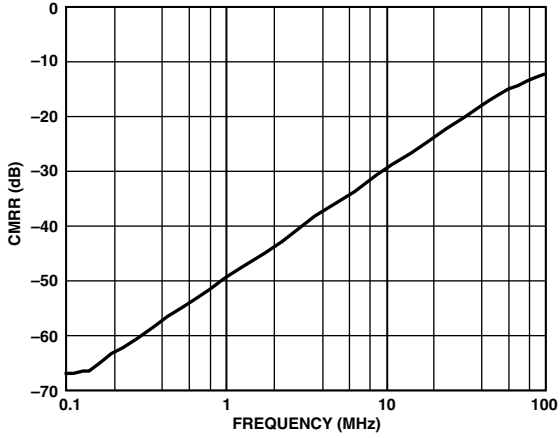

TPC 27. CMRR vs. Frequency

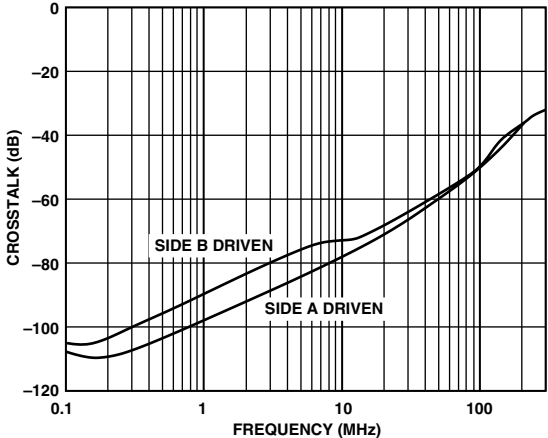

TPC 30. Crosstalk (Output-to-Output) vs. Frequency

AD8057/AD8058

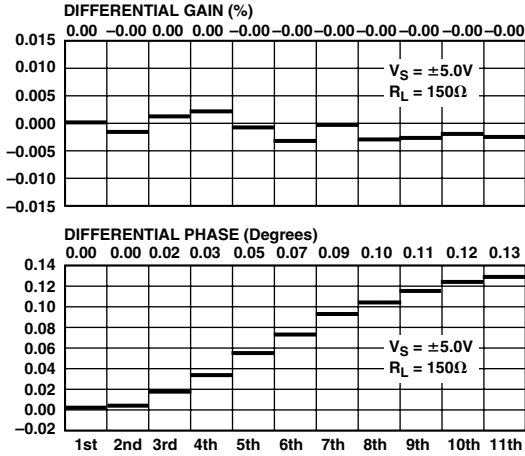

a.

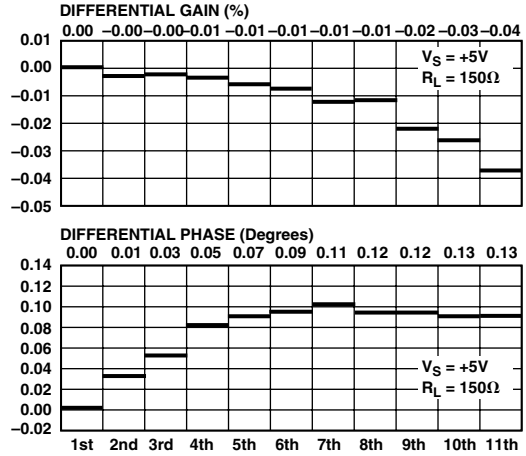

a.

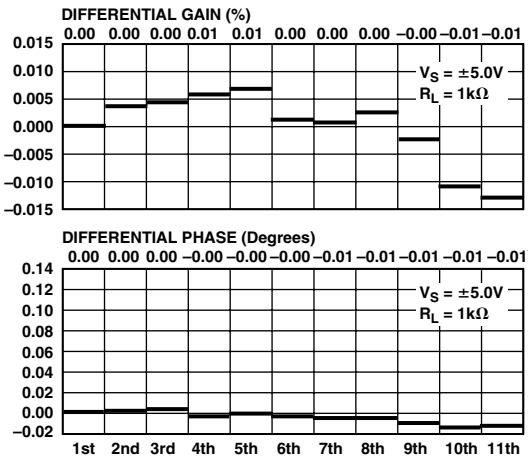

b.

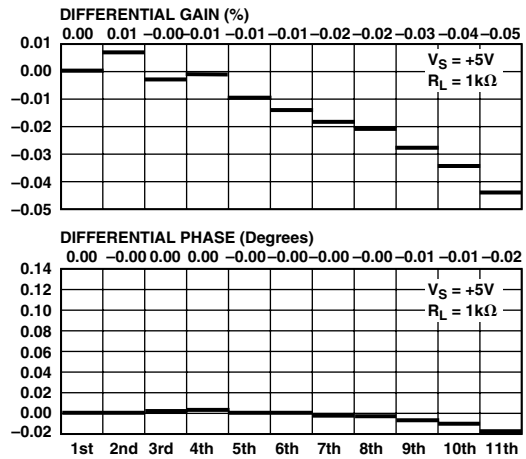

b.

TPC 31. Differential Gain and Differential Phase One Back Terminated Load (150 Ω) (Video Op Amps Only)

TPC 33. Differential Gain and Differential Phase, a. $R_L = 150\Omega$, b. $R_L = 1k\Omega$

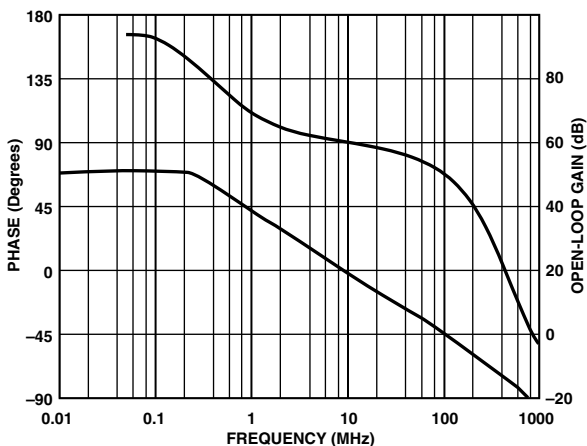

TPC 32. Open-Loop Gain and Phase vs. Frequency

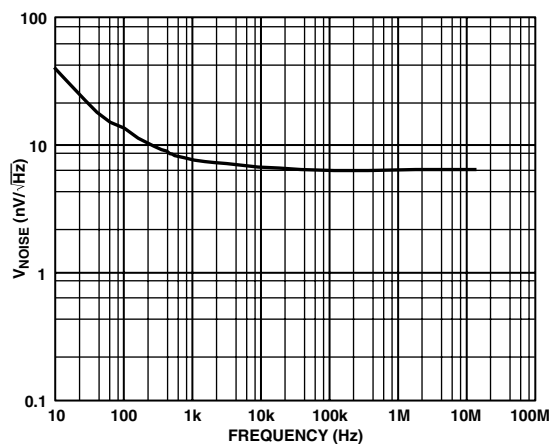

TPC 34. Voltage Noise vs. Frequency

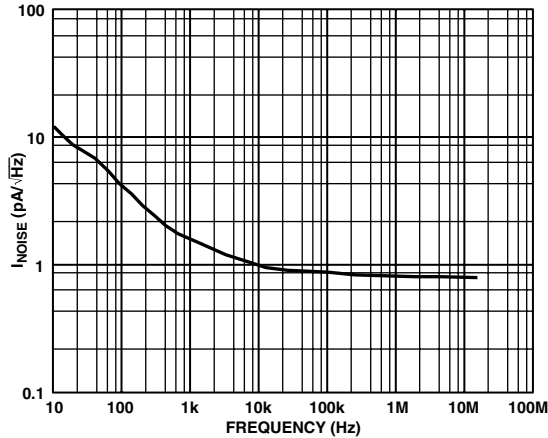

TPC 35. Current Noise vs. Frequency

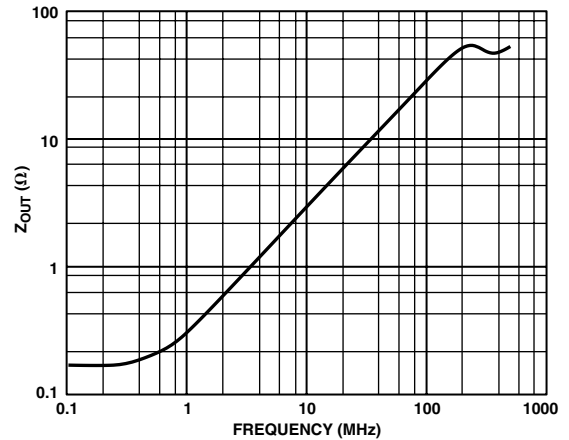

TPC 36. Output Impedance vs. Frequency

APPLICATIONS

Driving Capacitive Loads

When driving a capacitive load, most op amps will exhibit overshoot in their pulse response.

Figure 3 shows the relationship between the capacitive load that results in 30% overshoot and the closed-loop gain of an AD8058. It can be seen that, under the Gain = +2 condition, the device is stable with capacitive loads of up to 69 pF.

In general, to minimize peaking or to ensure device stability for larger values of capacitive loads, a small series resistor, R_S , can be added between the op amp output and the load capacitor, C_L , as shown in Figure 4.

For the setup shown in Figure 4, the relationship between R_S and C_L was empirically derived and is shown in Table I.

Table I. Recommended Value for Resistors R_S , R_F , R_G vs. Capacitive Load, C_L , Which Results in 30% Overshoot

Gain	R_F (Ω)	R_G (Ω)	C_L w/ $R_S = 0 \Omega$ (pF)	C_L w/ $R_S = 2.4 \Omega$ (pF)
1	100		11	13
2	100	100	51	69
3	100	50	104	153
4	100	33.2	186	270
5	100	25	245	500
10	100	11	870	1580

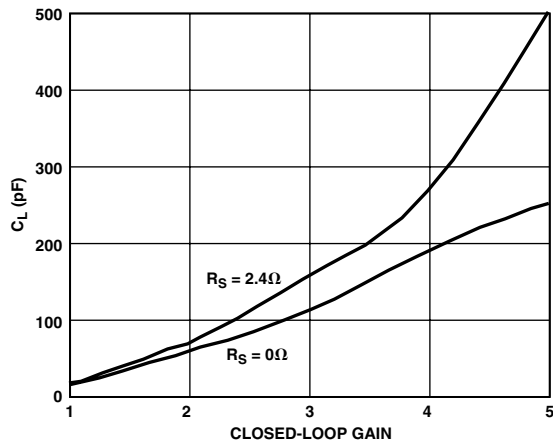

Figure 3. Capacitive Load Drive vs. Closed-Loop Gain

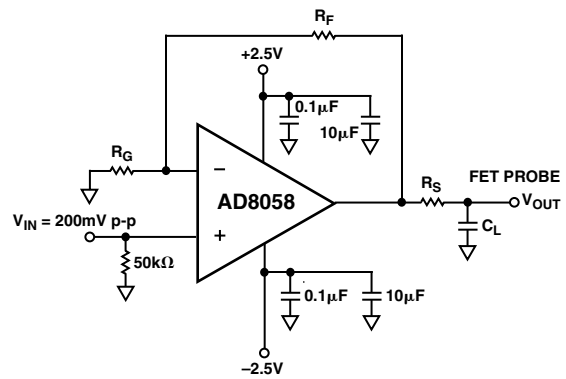

Figure 4. Capacitive Load Drive Circuit

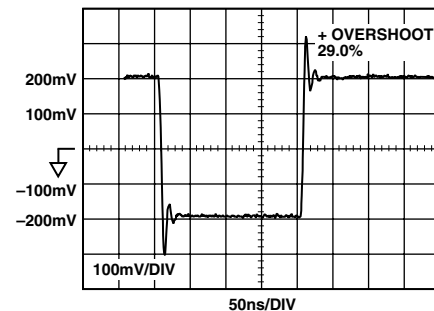

Figure 5. Typical Pulse Response with $C_L = 65 \text{ pF}$, Gain = +2, and $V_S = \pm 2.5 \text{ V}$

AD8057/AD8058

Video Filter

Some composite video signals that are derived from a digital source contain some clock feedthrough that can cause problems with downstream circuitry. This clock feedthrough is usually at 27 MHz, which is a standard clock frequency for both NTSC and PAL video systems. A filter that passes the video band and rejects frequencies at 27 MHz can be used to remove these frequencies from the video signal.

Figure 6 shows a circuit that uses an AD8057 to create a single 5 V supply, 3-pole Sallen-Key filter. This circuit uses a single RC pole in front of a standard 2-pole active section. To shift the dc operating point to midsupply, ac coupling is provided by R4, R5, and C4.

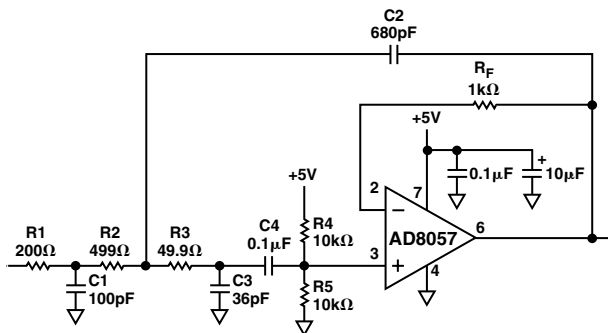

Figure 6. Low-Pass Filter for Video

Figure 7 shows a frequency sweep of this filter. The response is down 3 dB at 5.7 MHz, so it passes the video band with little attenuation. The rejection at 27 MHz is 42 dB, which provides more than a factor of 100 in suppression of the clock components at this frequency.

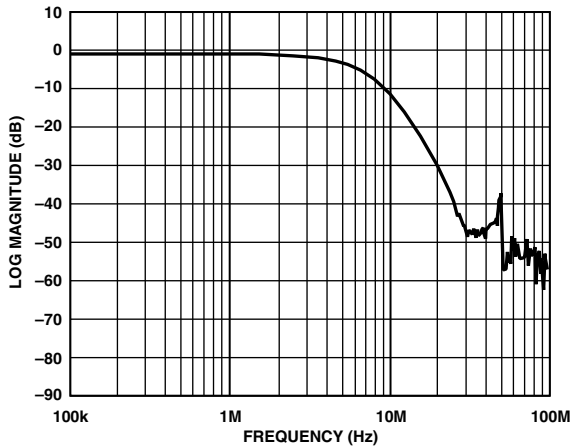

Figure 7. Video Filter Response

Differential A-to-D Driver

As system supply voltages are dropping, many ADCs provide differential analog inputs to increase the dynamic range of the input signal while still operating on a low supply voltage. Differential driving can also reduce second and other even-order distortion products.

Analog Devices offers an assortment of 12- and 14-bit high speed converters that have differential inputs and can be run from a single 5 V supply. These include the AD9220, AD9221, AD9223, AD9224, and AD9225 at 12 bits, and the AD9240, AD9241, and AD9243 at 14 bits. Although these devices can operate over a range of common-mode voltages at their analog inputs, they work best when the common-mode voltage at the input is at the midsupply or 2.5 V.

Op amp architectures that require upwards of 2 V of headroom at the output have significant problems when trying to drive such ADCs while operating with a 5 V positive supply. The low headroom output design of the AD8057 and AD8058 make them ideal for driving these types of ADCs.

The AD8058 can be used to make a dc-coupled, single-ended-to-differential driver for one of these ADCs. Figure 8 is a schematic of such a circuit for driving an AD9225, 12-bit, 25 MSPS ADC.

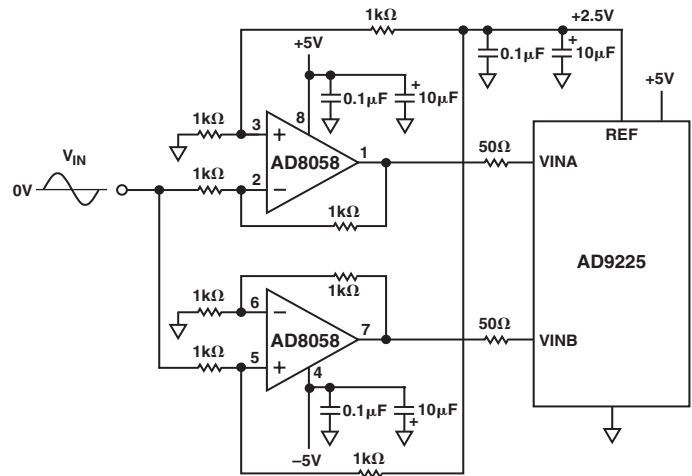

Figure 8. Schematic Circuit for Driving AD9225

In this circuit, one of the op amps is configured in the inverting mode, while the other is in the noninverting mode. However, to provide better bandwidth matching, each op amp is configured for a noise gain of +2. The inverting op amp is configured for a gain of -1, while the noninverting op amp is configured for a gain of +2. Each of these produces a noise gain of +2, which is only determined by the inverse of the feedback ratio. The input signal to the noninverting op amp is divided by 2 in order to normalize its level and make it equal to the inverting output.

For 0 V input, the outputs of the op amps want to be at 2.5 V, which is the midsupply level of the ADCs. This is accomplished by first taking the 2.5 V reference output of the ADC and dividing it by two by a pair of 1 k Ω resistors. The resulting 1.25 V is applied to each op amp's positive input. This voltage is then multiplied by the gain of +2 of the op amps to provide a 2.5 V level at each output.

The assumption for this circuit is that the input signal is bipolar with respect to ground and the circuit must be dc-coupled. This implies the existence of a negative supply elsewhere in the system. This circuit uses -5 V as the negative supply for the AD8058.

If the AD8058 negative supply were tied to ground, there would be a problem at the input of the noninverting op amp. The input common-mode voltage can only go to within 1 V of the negative rail. Since this circuit requires that the positive inputs operate with a 1.25 V bias, there is not enough room to swing this voltage in the negative direction. The inverting stage does

not have this problem because its common-mode input voltage remains fixed at 1.25 V. If dc coupling is not required, various ac coupling techniques can be used to eliminate this problem.

Layout

The AD8057 and AD8058 are high speed op amps and should be used in a board layout that follows standard high speed design rules. All the signal traces should be as short and direct as possible. In particular, the parasitic capacitance on the inverting input of each device should be kept to a minimum to avoid excessive peaking and other undesirable performance.

The power supplies should be bypassed very close to the power pins of the package with 0.1 μ F in parallel with a larger, approximately 10 μ F tantalum capacitor. These capacitors should be connected to a ground plane that is either on an inner layer or fills the area of the board that is not used for other signals.

AD8057/AD8058

OUTLINE DIMENSIONS

8-Lead Mini Small Outline Package [MSOP] (RM-8)

Dimensions shown in millimeters

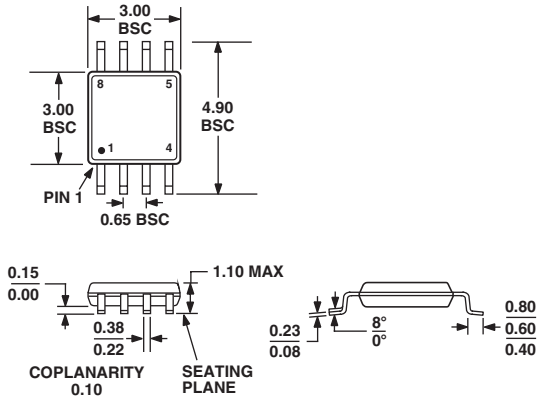

8-Lead Standard Small Outline Package [SOIC] (R-8)

Dimensions shown in millimeters and (inches)

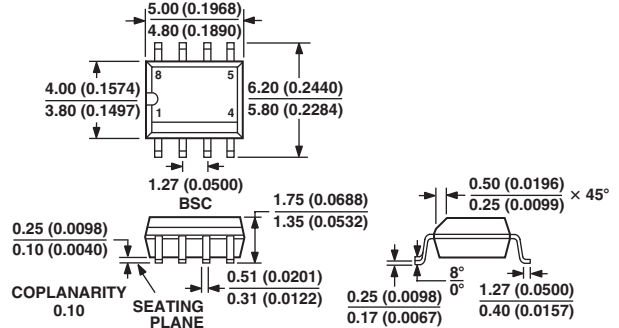

5-Lead Small Outline Transistor Package [SOT-23] (RT-5)

Dimensions shown in millimeters

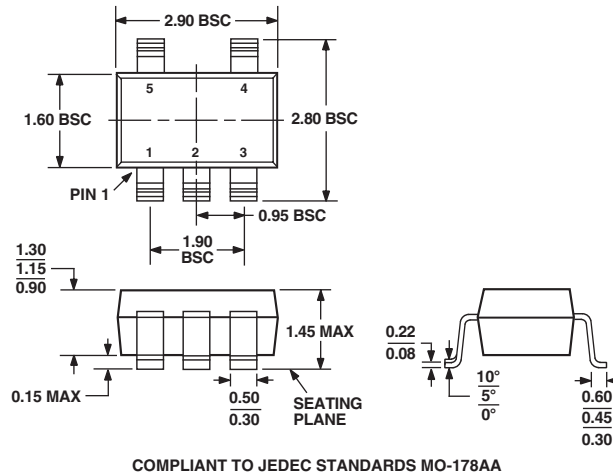

Revision History

Location	Page
8/03—Data Sheet changed from REV. A to REV. B.	
Renumbered Figures and TPCs	Universal
Changes to ORDERING GUIDE	4
Change to Figure 8	12
Updated OUTLINE DIMENSIONS	14

