



Industrial Current/Voltage Output Driver with Programmable Ranges

AD5748

FEATURES

Current output ranges: 4 mA to 21 mA, 0 mA to 21 mA

±0.15% FSR total unadjusted error (TUE)

±5 ppm/°C FSR typical output drift

Voltage output ranges: 0 V to 5 V, 0 V to 10.5 V, ±10.5 V

±0.05% FSR total unadjusted error (TUE)

±3 ppm/°C FSR output drift

Flexible serial digital interface

On-chip output fault detection

PEC error checking

Asynchronous CLEAR function

Flexible power-up condition to 0 V or tristate

Power supply range

AV_{DD}: +12 V (± 10%) to +24 V (± 10%)

AV_{SS}: -12 V (± 10%) to -24 V (± 10%)

Output loop compliance to AV_{DD} - 2.75 V

Temperature range: -40°C to +105°C

32-lead, 5 mm × 5 mm LFCSP package

APPLICATIONS

Process control

Actuator control

PLCs

GENERAL DESCRIPTION

The AD5748 is a single-channel, low cost, precision, voltage/current output driver with hardware or software programmable output ranges. The software ranges are configured via an SPI-/MICROWIRE™-compatible serial interface. The AD5748 targets applications in PLC and industrial process control. The analog input to the AD5748 is provided from a low voltage, single-supply, digital-to-analog converter (DAC) and is internally conditioned to provide the desired output current/voltage range. The analog input range is 0 V to 4.096 V.

The output current range is programmable across two current ranges: 4 mA to 21 mA and 0 mA to 21 mA.

Voltage output is provided from a separate pin that can be configured to provide 0 V to 5 V, 0 V to 10.5 V, or ±10.5 V output range.

Analog outputs are short-circuit and open-circuit protected and can drive capacitive loads of 2 μF and inductive loads of 0.1 H.

The device is specified to operate with a power supply range from ±12 V to ±24 V. Output loop compliance is 0 V to AV_{DD} - 2.75 V.

The flexible serial interface is SPI- and MICROWIRE-compatible and can be operated in 3-wire mode to minimize the digital isolation required in isolated applications. The interface also features an optional PEC error checking feature using CRC-8 error checking, useful in industrial environments where data communication corruption can occur.

The device also includes a power-on-reset function, ensuring that the device powers up in a known state (0 V or tristate), and a asynchronous CLEAR pin that sets the outputs to zero scale/midscale voltage output or the low end of the selected current range.

An HW SELECT pin is used to configure the part for hardware or software mode on power-up.

Note that the plots in the Typical Performance Characteristics section of this data sheet contain information on the standard ranges, as released in the [AD5750/AD5750-1](#) data sheet. Although the overranges have been tested, new plots were not generated and substitution data was used for plotting purposes.

Table 1. Related Device

Part Number	Description
AD5422	Single-channel, 16-bit, serial input current source and voltage output DAC

Rev. 0

Information furnished by Analog Devices is believed to be accurate and reliable. However, no responsibility is assumed by Analog Devices for its use, nor for any infringements of patents or other rights of third parties that may result from its use. Specifications subject to change without notice. No license is granted by implication or otherwise under any patent or patent rights of Analog Devices. Trademarks and registered trademarks are the property of their respective owners.

TABLE OF CONTENTS

Features	1	Reset Function	25
Applications.....	1	OUTEN.....	25
General Description	1	Software Control	25
Revision History	2	Hardware Control	27
Functional Block Diagram	3	Transfer Function	27
Specifications.....	4	Detailed Description of Features.....	28
Timing Characteristics	7	Output Fault Alert—Software Mode	28
Absolute Maximum Ratings.....	9	Output Fault Alert—Hardware Mode	28
ESD Caution.....	9	Voltage Output Short-Circuit Protection.....	28
Pin Configuration and Function Descriptions.....	10	Asynchronous Clear (CLEAR)	28
Typical Performance Characteristics	12	Current Setting Resistor	29
Voltage Output.....	12	Packet Error Checking.....	29
Current Output.....	16	Applications Information	30
Terminology	21	Transient Voltage Protection	30
Theory of Operation	22	Thermal Considerations.....	30
Software Mode	22	Layout Guidelines.....	30
Current Output Architecture.....	24	Galvanically Isolated Interface	31
Driving Inductive Loads.....	24	Microprocessor Interfacing.....	31
Power-On State of the AD5748	24	Outline Dimensions	32
Default Registers at Power-On	25	Ordering Guide	32

REVISION HISTORY**3/10—Revision 0: Initial Version**

FUNCTIONAL BLOCK DIAGRAM

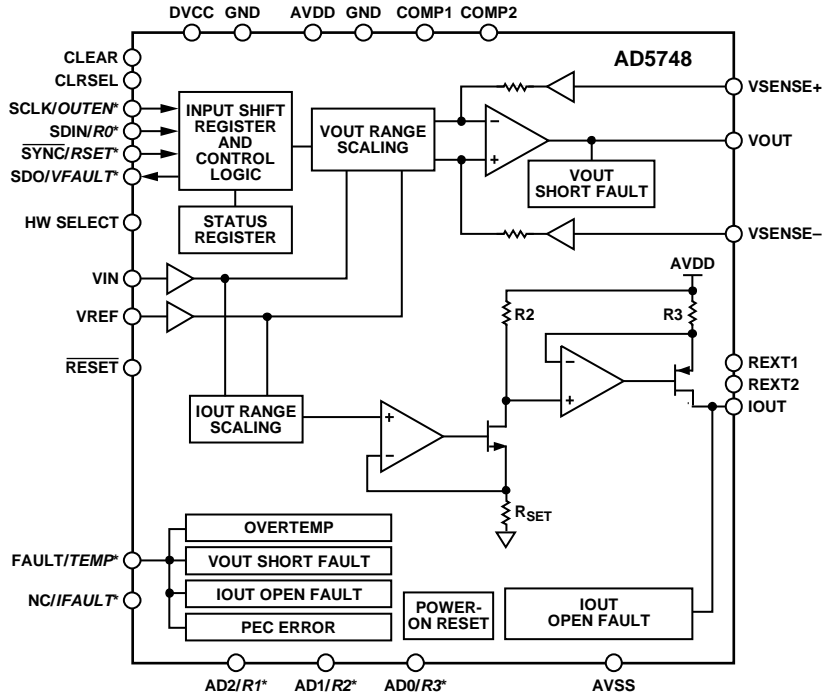

* DENOTES SHARED PIN. SOFTWARE MODE DENOTED BY REGULAR TEXT, HARDWARE MODE DENOTED BY *ITALIC* TEXT. FOR EXAMPLE, FOR *FAULT/TEMP* PIN, IN SOFTWARE MODE, THIS PIN TAKES ON FAULT FUNCTION. IN HARDWARE MODE, THIS PIN TAKES ON *TEMP* FUNCTION.

09822-001

Figure 1.

SPECIFICATIONS

$AV_{DD}/AV_{SS} = \pm 12\text{ V} (\pm 10\%)$ to $\pm 24\text{ V} (\pm 10\%)$, $DV_{CC} = 2.7\text{ V}$ to 5.5 V , $GND = 0\text{ V}$. I_{OUT} : $R_{LOAD} = 300\ \Omega$. All specifications T_{MIN} to T_{MAX} , unless otherwise noted.

Table 2.

Parameter ¹	Min	Typ	Max	Unit	Test Conditions/Comments
INPUT VOLTAGE RANGE					Output unloaded
V_{IN}		0 to 4.096		V	
Input Leakage Current	-1		+1	μA	
REFERENCE INPUT					
Reference Input Voltage		4.096		V	External reference needs to be exactly as stated; otherwise, accuracy errors show up as error in output
Input Leakage Current	-1		+1	μA	
VOLTAGE OUTPUT, V_{OUT}					
Output Voltage Ranges	0		5	V	AVDD must have minimum 1.3 V headroom AVDD/AVSS must have minimum 1.3 V headroom
	0		10.5	V	
	-10.5		+10.5	V	
Accuracy					
Total Unadjusted Error (TUE) ²	-0.3		+0.3	% FSR	$T_A = 25^\circ\text{C}$
	-0.1	± 0.05	+0.1	% FSR	
Relative Accuracy (INL)	-0.02	± 0.005	+0.02	% FSR	
Bipolar Zero Error (Offset at Midscale)	-10		+10	mV	$\pm 10.5\text{ V range}$
	-8	± 0.5	+8	mV	$T_A = 25^\circ\text{C}, \pm 10.5\text{ V range}$
Bipolar Zero Error TC^3		± 1.5		ppm FSR/ $^\circ\text{C}$	$\pm 10.5\text{ V range}$
Zero-Scale Error	-10		+10	mV	$\pm 10.5\text{ V range}$
	-8	± 0.5	+8	mV	$T_A = 25^\circ\text{C}, \pm 10.5\text{ V range}$
Zero-Scale Error TC^3		± 1		ppm FSR/ $^\circ\text{C}$	$\pm 10.5\text{ V range}$
Zero-Scale/Offset Error	-5		+5	mV	0 V to 10.5 V range
	-4	± 0.5	+4	mV	$T_A = 25^\circ\text{C}, 0\text{ V to } 10.5\text{ V range}$
	-3		+3	mV	0 V to 5 V range
	-2.2	± 0.3	+2.2	mV	$T_A = 25^\circ\text{C}, 0\text{ V to } 5\text{ V range}$
Offset Error TC^3		± 2		ppm FSR/ $^\circ\text{C}$	
Gain Error	-0.05		+0.05	% FSR	All ranges
	-0.04	± 0.015	+0.04	% FSR	$T_A = 25^\circ\text{C}$
Gain Error TC^3		± 0.5		ppm FSR/ $^\circ\text{C}$	
Full-Scale Error	-0.05		+0.05	% FSR	All ranges
	-0.04	± 0.015	+0.04	% FSR	$T_A = 25^\circ\text{C}$
Full-Scale Error TC^3		± 1.5		ppm FSR/ $^\circ\text{C}$	
VOLTAGE OUTPUT CHARACTERISTICS ³					
Headroom			1.3	V	Output unloaded
Short-Circuit Current		15		mA	
Load	1			k Ω	
Capacitive Load Stability					$T_A = 25^\circ\text{C}$
$R_{LOAD} = \infty$			1	nF	
$R_{LOAD} = 2\text{ k}\Omega$			1	nF	
$R_{LOAD} = \infty$			2	μF	External compensation capacitor required; see the Driving Inductive Loads section
DC Output Impedance		0.12		Ω	
0 V to 5 V range, $\frac{1}{4}$ to $\frac{3}{4}$ Step		7		μs	Specified with $2\text{ k}\Omega \parallel 220\text{ pF}, \pm 0.05\%$
0 V to 5 V range, 40 mV Input Step		4.5		μs	Specified with $2\text{ k}\Omega \parallel 220\text{ pF}, \pm 0.05\%$
Slew Rate		2		V/ μs	Specified with $2\text{ k}\Omega \parallel 220\text{ pF}$
Output Noise		2.5		$\mu\text{V rms}$	0.1 Hz to 10 Hz bandwidth
		45.5		$\mu\text{V rms}$	100 kHz bandwidth

Parameter ¹	Min	Typ	Max	Unit	Test Conditions/Comments
Output Noise Spectral Density		165		nV/ $\sqrt{\text{Hz}}$	Measured at 10 kHz; specified with 2 k Ω 220 pF 200 mV, 50 Hz/60 Hz sine wave superimposed on power supply voltage Outputs unloaded
AC PSRR		-65		dB	
DC PSRR		10		$\mu\text{V}/\text{V}$	
CURRENT OUTPUT, I_{OUT}					
Output Current Ranges	0		21	mA	
	4		21	mA	
Accuracy, Internal R_{SET}^4					$T_A = 25^\circ\text{C}$
Total Unadjusted Error (TUE) ²	-0.5		+0.5	% FSR	
	-0.3	± 0.15	+0.3	% FSR	4 mA to 21 mA, 0 mA to 21 mA
Relative Accuracy (INL)	-0.02	± 0.01	+0.02	% FSR	
Offset Error	-16		+16	μA	4 mA to 21 mA, 0 mA to 21 mA
	-10	+5	+10	μA	
Offset Error TC ³		± 3		ppm FSR/ $^\circ\text{C}$	4 mA to 21 mA, 0 mA to 21 mA
Gain Error	-0.2		+0.2	% FSR	4 mA to 21 mA, 0 mA to 21 mA
	-0.03	± 0.006	+0.03	% FSR	
Gain TC ³		± 8		ppm FSR/ $^\circ\text{C}$	4 mA to 21 mA, 0 mA to 21 mA
Full-Scale Error	-0.2		+0.2	% FSR	4 mA to 21 mA, 0 mA to 21 mA
	-0.125	± 0.02	+0.125	% FSR	
Full-Scale TC ³		± 4		ppm FSR/ $^\circ\text{C}$	4 mA to 21 mA, 0 mA to 21 mA
Accuracy, External R_{SET}^4					$T_A = 25^\circ\text{C}$
Total Unadjusted Error (TUE) ²	-0.3		+0.3	% FSR	
	-0.1	± 0.02	+0.1	% FSR	4 mA to 21 mA, 0 mA to 21 mA
Relative Accuracy (INL)	-0.02	± 0.01	+0.02	% FSR	
Offset Error	-14		+14	μA	4 mA to 21 mA, 0 mA to 21 mA
	-11	+5	+11	μA	
Offset Error TC ³		± 2		ppm FSR/ $^\circ\text{C}$	4 mA to 21 mA, 0 mA to 21 mA
Gain Error	-0.08		+0.08	% FSR	4 mA to 21 mA, 0 mA to 21 mA
	-0.07	± 0.02	+0.07	% FSR	
Gain TC		± 1		ppm FSR/ $^\circ\text{C}$	4 mA to 21 mA, 0 mA to 21 mA
Full-Scale Error	-0.1		+0.1	% FSR	4 mA to 21 mA, 0 mA to 21 mA
	-0.07	± 0.02	+0.07	% FSR	
Full-Scale TC ³		± 2		ppm FSR/ $^\circ\text{C}$	4 mA to 21 mA, 0 mA to 21 mA
CURRENT OUTPUT CHARACTERISTICS³					
Current Loop Compliance Voltage	0		$A_{\text{VDD}} - 2.75$	V	Chosen so that compliance is not exceeded
Resistive Load		See comments			
Inductive Load		See comments			Needs appropriate capacitor at higher inductance values; see the Driving Inductive Loads section
Settling Time					250 Ω load
4 mA to 21 mA, Full-Scale Step		8.5		μs	
120 μA Step, 4 mA to 21 mA Range		1.2	A_{I}	μs	250 Ω load
DC PSRR			1	$\mu\text{A}/\text{V}$	
Output Impedance		130		M Ω	
DIGITAL INPUT					
Input High Voltage, V_{IH}	2			V	JEDEC compliant
Input Low Voltage, V_{IL}			0.8	V	
Input Current	-1		+1	μA	Per pin
Pin Capacitance		5		pF	Per pin
DIGITAL OUTPUTS³					
FAULT, IFAULT, TEMP, VFAULT					10 k Ω pull-up resistor to DVCC At 2.5 mA
Output Low Voltage, V_{OL}			0.4	V	
Output Low Voltage, V_{OL}		0.6		V	
Output High Voltage, V_{OH}	3.6			V	10 k Ω pull-up resistor to DVCC

AD5748

Parameter ¹	Min	Typ	Max	Unit	Test Conditions/Comments
SDO					
Output Low Voltage, V_{OL}	0.5	0.5		V	Sinking 200 μ A
Output High Voltage, V_{OH}	DVCC – 0.5	DVCC – 0.5		V	Sourcing 200 μ A
High Impedance Output Capacitance		3		pF	
High Impedance Leakage Current	–1		+1	μ A	
POWER REQUIREMENTS					
Positive Analog Supply, AV_{DD}	12		24	V	$\pm 10\%$
Negative Analog Supply, AV_{SS}	–12		–24	V	$\pm 10\%$
Digital Power Supply, DV_{CC}					
Input Voltage	2.7		5.5	V	
I_{DD}		4.4	5.2	mA	Output unloaded, output disabled, R3, R2, R1, R0 = 0, 1, 0, 1
		5.2	6.2	mA	Current output enabled
		5.2	6.2	mA	Voltage output enabled
I_{SS}		2.0	2.5	mA	Output unloaded, output disabled, R3, R2, R1, R0 = 0, 1, 0, 1
		2.5	3	mA	Current output enabled
		2.5	3	mA	Voltage output enabled
$D_{I_{CC}}$		0.3	1	mA	$V_{IH} = DV_{CC}, V_{IL} = GND$
Power Dissipation		108		mW	$AV_{DD}/AV_{SS} = \pm 24$ V, outputs unloaded

¹ Temperature range: –40°C to +105°C; typical at +25°C.

² Specification includes gain and offset errors over temperature, and drift after 1000 hours, $T_A = 125^\circ\text{C}$.

³ Guaranteed by characterization, but not production tested.

⁴ See the Current Setting Resistor section.

TIMING CHARACTERISTICS

$AV_{DD}/AV_{SS} = \pm 12\text{ V} (\pm 10\%)$ to $\pm 24\text{ V} (\pm 10\%)$, $DV_{CC} = 2.7\text{ V}$ to 5.5 V , $GND = 0\text{ V}$. V_{OUT} : $R_{LOAD} = 2\text{ k}\Omega$, $C_L = 200\text{ pF}$, I_{OUT} : $R_{LOAD} = 300\ \Omega$. All specifications T_{MIN} to T_{MAX} , unless otherwise noted.

Table 3.

Parameter ^{1,2}	Limit at T_{MIN} , T_{MAX}	Unit	Description
t_1	20	ns min	SCLK cycle time
t_2	8	ns min	SCLK high time
t_3	8	ns min	SCLK low time
t_4	5	ns min	\overline{SYNC} falling edge to SCLK falling edge setup time
t_5	10	ns min	16 th SCLK falling edge to \overline{SYNC} rising edge (on 24 th SCLK falling edge if using PEC)
t_6	5	ns min	Minimum \overline{SYNC} high time (write mode)
t_7	5	ns min	Data setup time
t_8	5	ns min	Data hold time
t_9, t_{10}	1.5	μs max	CLEAR pulse low/high activation time
t_{11}	5	ns min	Minimum \overline{SYNC} high time (read mode)
t_{12}	40	ns max	SCLK rising edge to SDO valid (SDO $C_L = 15\text{ pF}$)
t_{13}	10	ns min	\overline{RESET} pulse low time

¹ Guaranteed by characterization, but not production tested.

² All input signals are specified with $t_R = t_F = 5\text{ ns}$ (10% to 90% of DV_{CC}) and timed from a voltage level of 1.2 V.

Timing Diagrams

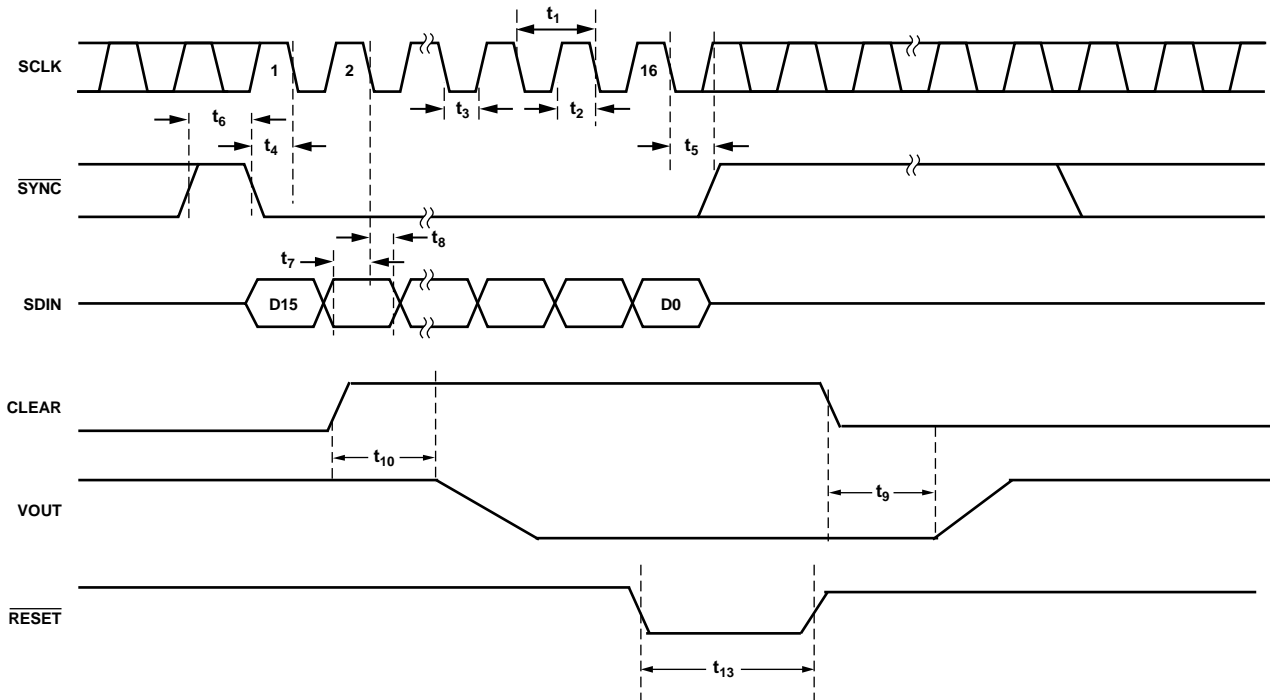

08922-002

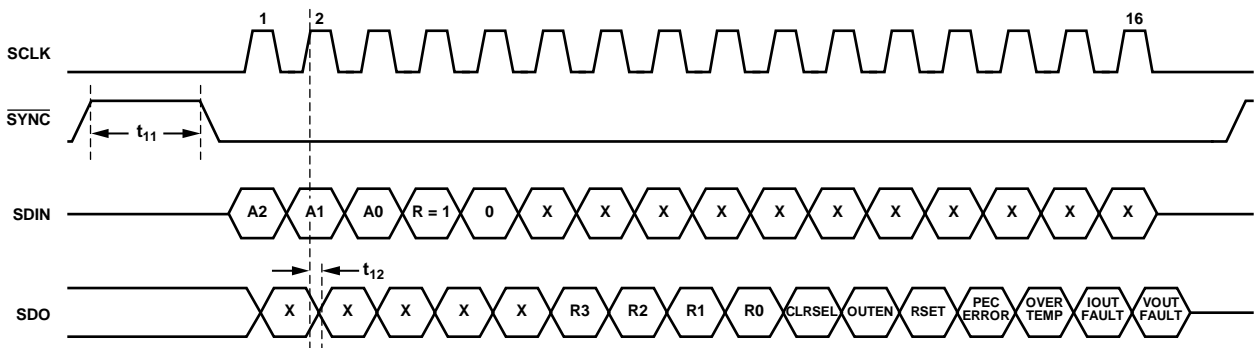

08922-003

ABSOLUTE MAXIMUM RATINGS

$T_A = 25^\circ\text{C}$ unless otherwise noted.

Transient currents of up to 100 mA do not cause SCR latch-up.

Table 4.

Parameter	Rating
AVDD to GND	-0.3 V to +30 V
AVSS to GND	+0.3 V to -28 V
AVDD to AVSS	-0.3 V to +58 V
DVCC to GND	-0.3 V to +7 V
VSENSE+ to GND	AVSS to AVDD
VSENSE- to GND	± 5.0 V
Digital Inputs to GND	-0.3 V to $DV_{CC} + 0.3$ V or 7 V (whichever is less)
Digital Outputs to GND	-0.3 V to $DV_{CC} + 0.3$ V or 7 V (whichever is less)
VREF to GND	-0.3 V to +7 V
VIN to GND	-0.3 V to +7 V
VOUT, IOUT to GND	AVSS to AVDD
Operating Temperature Range, Industrial	-40°C to +105°C
Storage Temperature Range	-65°C to +150°C
Junction Temperature (T_J max)	125°C
32-Lead LFCSP Package	
θ_{JA} Thermal Impedance	28°C/W
Lead Temperature	JEDEC industry standard
Soldering	J-STD-020
ESD (Human Body Model)	3 kV

Stresses above those listed under Absolute Maximum Ratings may cause permanent damage to the device. This is a stress rating only; functional operation of the device at these or any other conditions above those indicated in the operational section of this specification is not implied. Exposure to absolute maximum rating conditions for extended periods may affect device reliability.

ESD CAUTION



ESD (electrostatic discharge) sensitive device.

Charged devices and circuit boards can discharge without detection. Although this product features patented or proprietary protection circuitry, damage may occur on devices subjected to high energy ESD. Therefore, proper ESD precautions should be taken to avoid performance degradation or loss of functionality.

PIN CONFIGURATION AND FUNCTION DESCRIPTIONS

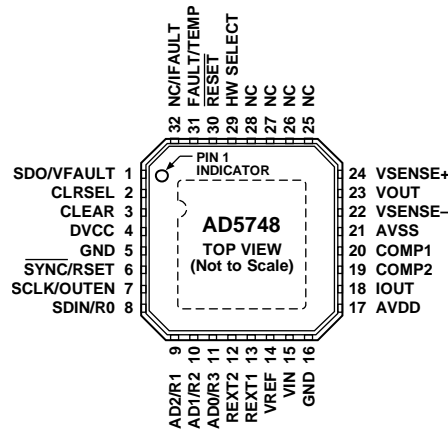

- NOTES**
 1. NC = NO CONNECT.
 2. THE EXPOSED PADDLE IS TIED TO AVSS.

08922-004

Figure 4. Pin Configuration

Table 4. Pin Function Descriptions

Pin No.	Mnemonic	Description
1	SDO/VFAULT	Serial Data Output (SDO). In software mode, this pin is used to clock data from the input shift register in readback mode. Data is clocked out on the rising edge of SCLK and is valid on the falling edge of SCLK. This pin is a CMOS output. Short-Circuit Fault Alert (VFAULT). In hardware mode, this pin acts as a short-circuit fault alert pin and is asserted low when a short-circuit error is detected. This pin is an open-drain output and must be connected to a pull-up resistor.
2	CLRSEL	In hardware or software mode, this pin selects the clear value, either zero-scale or midscale code. In software mode, this pin is implemented as a logic OR with the internal CLRSEL bit.
3	CLEAR	Active High Input. Asserting this pin sets the output current/voltage to zero-scale code or midscale code of the range selected (user-selectable). CLEAR is a logic OR with the internal clear bit. In software mode, during power-up, the CLEAR pin level determines the power-on condition of the voltage channel, which can be active 0 V or tristate. See the Asynchronous Clear (CLEAR) section for more details.
4	DVCC	Digital Power Supply.
5	GND	Ground Connection.
6	SYNC/RSET	Positive Edge-Sensitive Latch (SYNC). In software mode, a rising edge parallel loads the input shift register data into the AD5748, also updating the output. Resistor Select (RSET). In hardware mode, this pin chooses whether the internal or the external current sense resistor is used. If RSET = 0, the external sense resistor is chosen. If RSET = 1, the internal sense resistor is chosen.
7	SCLK/OUTEN	Serial Clock Input (SCLK). In software mode, data is clocked into the input shift register on the falling edge of SCLK. This pin operates at clock speeds of up to 50 MHz. Output Enable (OUTEN). In hardware mode, this pin acts as an output enable pin.
8	SDIN/R0	Serial Data Input (SDIN). In software mode, data must be valid on the falling edge of SCLK. Range Decode Bit (R0). In hardware mode, this pin, in conjunction with R1, R2, and R3, selects the output current/voltage range setting on the part.
9	AD2/R1	Device Addressing Bit (AD2). In software mode, this pin, in conjunction with AD1 and AD0, allows up to eight devices to be addressed on one bus. Range Decode Bit (R1). In hardware mode, this pin, in conjunction with R0, R2, and R3, selects the output current/voltage range setting on the part.
10	AD1/R2	Device Addressing Bit (AD1). In software mode, this pin, in conjunction with AD2 and AD0 allows up to eight devices to be addressed on one bus. Range Decode Bit (R2). In hardware mode, this pin, in conjunction with R0, R1, and R3, selects the output current/voltage range setting on the part.

Pin No.	Mnemonic	Description
11	AD0/R3	Device Addressing Bit (AD0). In software mode, this pin, in conjunction with AD1 and AD2, allows up to eight devices to be addressed on one bus. Range Decode Bit (R3). In hardware mode, this pin, in conjunction with, R0, R1, and R2, selects the output current/voltage range setting on the part.
12, 13	REXT2, REXT1	A 15 kΩ external current setting resistor can be connected between the REXT1 and REXT2 pins to improve the IOUT temperature drift performance.
14	VREF	Buffered Reference Input.
15	VIN	Buffered Analog Input (0 V to 4.096 V).
16	GND	Ground Connection.
17	AVDD	Positive Analog Supply Pin.
18	IOUT	Current Output Pin.
19, 20	COMP2, COMP1	Optional Compensation Capacitor Connections for the Voltage Output Buffer. These are used to drive higher capacitive loads on the output. These pins also reduce overshoot on the output. Care should be taken when choosing the value of the capacitor connected between the COMP1 and COMP2 pins because it has a direct influence on the settling time of the output. See the Driving Large Capacitive Loads section for further details.
21	AVSS	Negative Analog Supply Pin.
22	VSENSE-	Sense Connection for the Negative Voltage Output Load Connection. This pin must stay within ± 3.0 V of ground for correct operation.
23	VOUT	Buffered Analog Output Voltage.
24	VSENSE+	Sense Connection for the Positive Voltage Output Load Connection.
25, 26, 27, 28	NC	No Connect. Can be tied to GND.
29	HW SELECT	This pin is used to configure the part to hardware or software mode. HW SELECT = 0 selects software control. HW SELECT = 1 selects hardware control.
30	$\overline{\text{RESET}}$	Resets the part to its power-on state.
31	FAULT/TEMP	Fault Alert (FAULT). In software mode, this pin acts as a general fault alert pin. It is asserted low when an open circuit, short circuit, overtemperature error, or PEC interface error is detected. This pin is an open-drain output and must be connected to a pull-up resistor. Overtemperature Fault (TEMP). In hardware mode, this pin acts as an overtemperature fault pin. It is asserted low when an overtemperature error is detected. This pin is an open-drain output and must be connected to a pull-up resistor.
32	NC/IFault	No Connect (NC). In software mode, this pin is a no connect. Instead, tie this pin to GND. Open-Circuit Fault Alert (IFault). In hardware mode, this pin acts as an open-circuit fault alert pin. It is asserted low when an open-circuit error is detected. This pin is an open-drain output and must be connected to a pull-up resistor.
33 (EPAD)	Exposed paddle	The exposed paddle is tied to AVSS.

TYPICAL PERFORMANCE CHARACTERISTICS

VOLTAGE OUTPUT

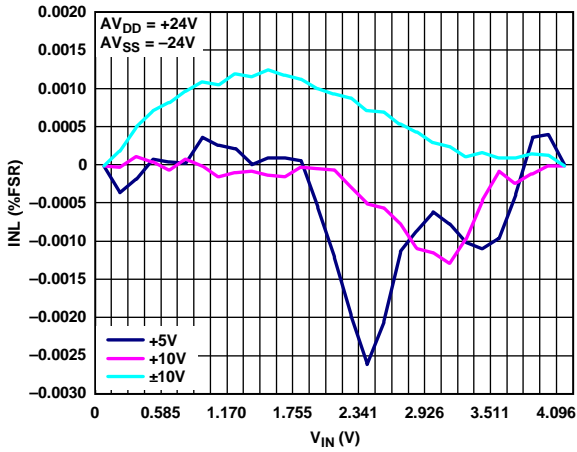

Figure 5. Integral Nonlinearity Error vs. V_{IN}

08922-005

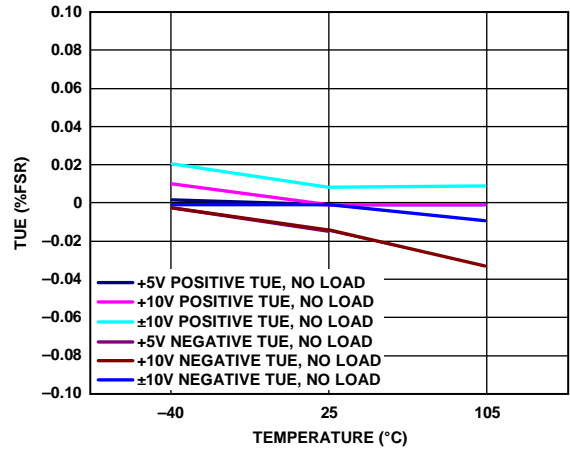

Figure 8. Total Unadjusted Error vs. Temperature

08922-008

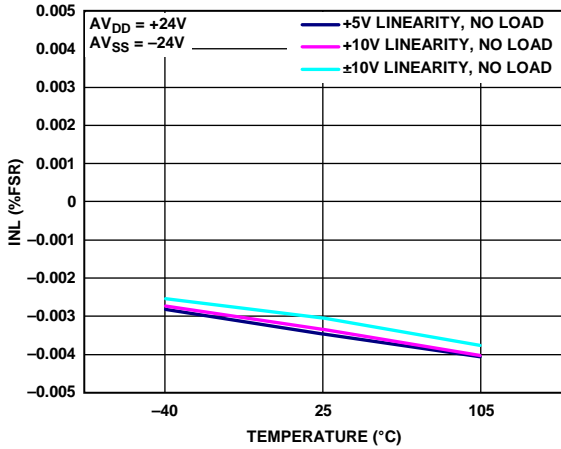

Figure 6. Integral Nonlinearity Error vs. Temperature

08922-006

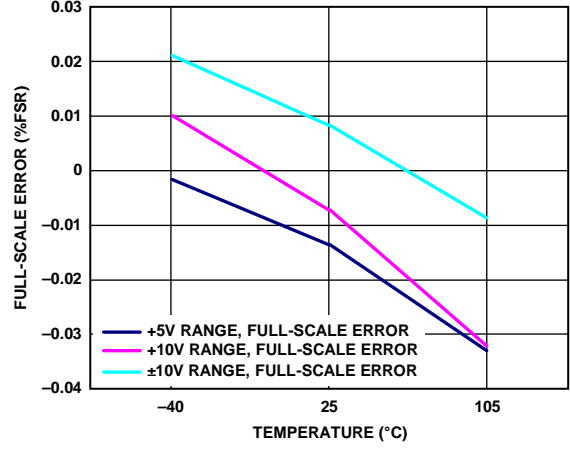

Figure 9. Full-Scale Error vs. Temperature

08922-009

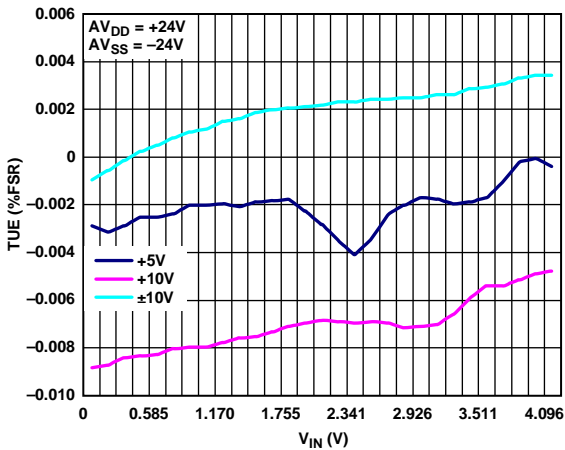

Figure 7. Total Unadjusted Error vs. V_{IN}

08922-007

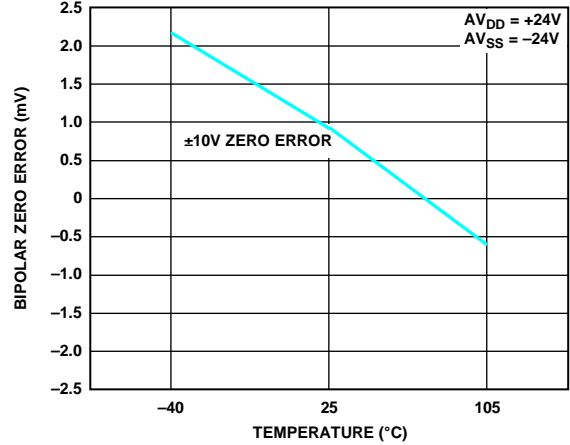

Figure 10. Bipolar Zero Error vs. Temperature

08922-010

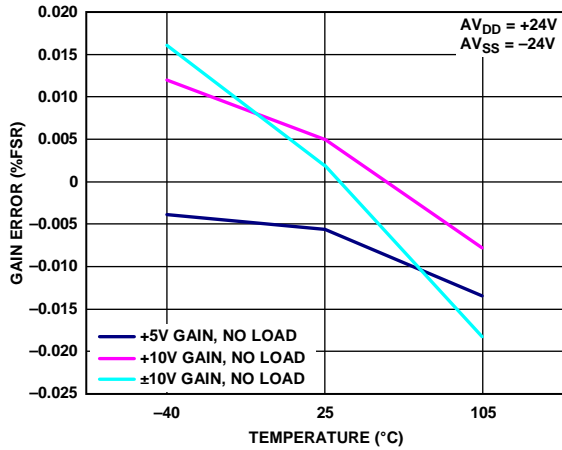

Figure 11. Gain Error vs. Temperature

08922-011

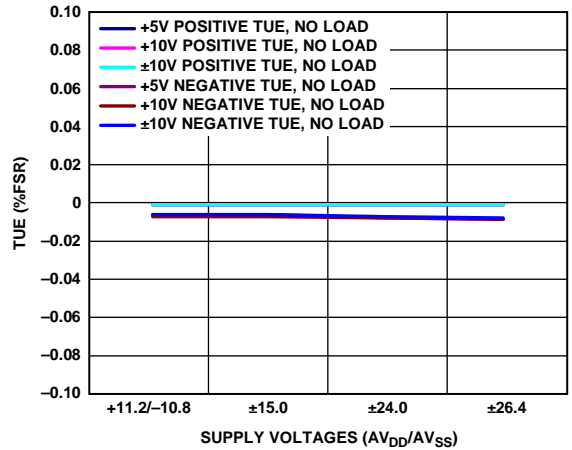

Figure 14. Total Unadjusted Error vs. Supply Voltages

08922-014

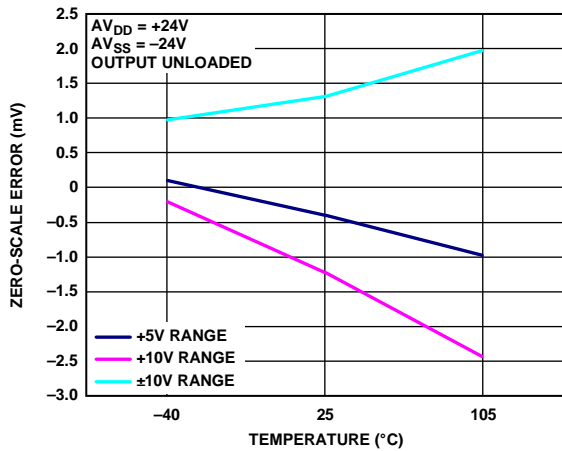

Figure 12. Zero-Scale Error (Offset Error) vs. Temperature

08922-012

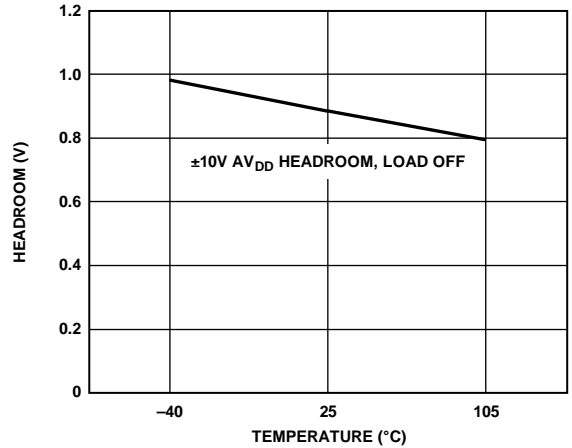

Figure 15. AVDD Headroom, ±10V Range, Output Set to 10V, Load Off

08922-015

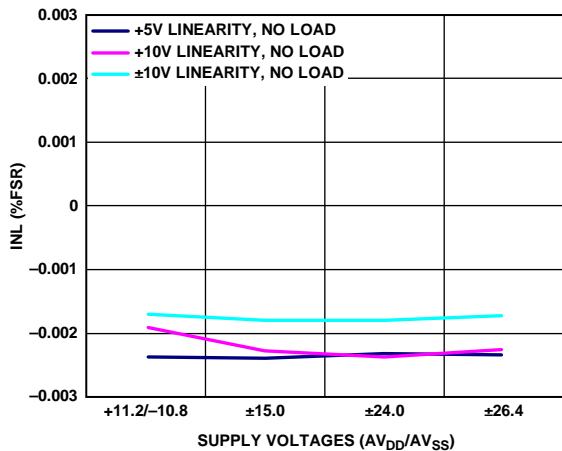

Figure 13. Integral Nonlinearity Error vs. Supply Voltage

08922-013

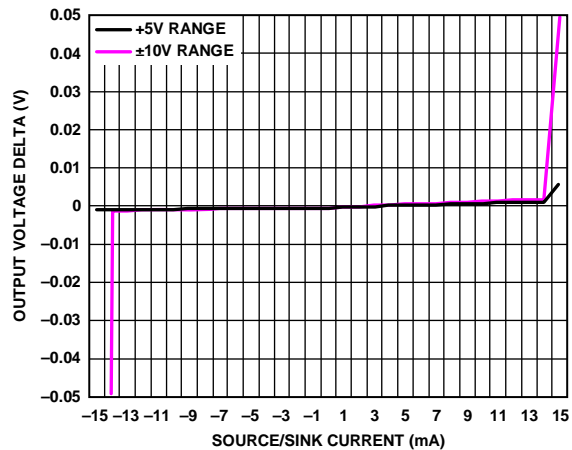

Figure 16. Source and Sink Capability of Output Amplifier

08922-016

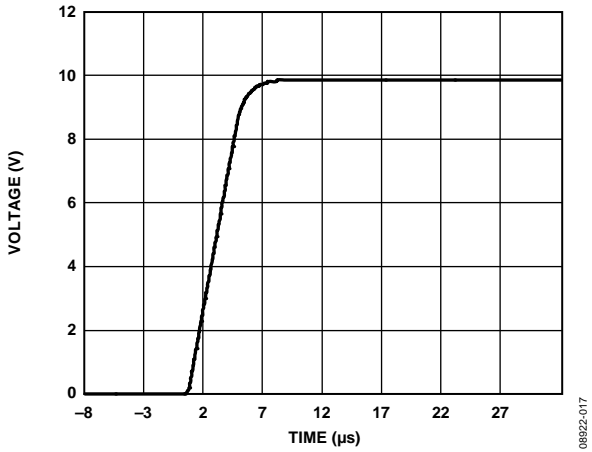

Figure 17. Full-Scale Positive Step

08922-017

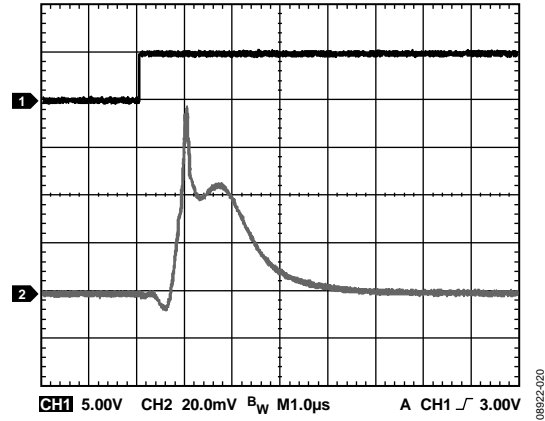

Figure 20. V_{OUT} Enable Glitch, Load = $2\text{ k}\Omega \parallel 1\text{ nF}$

08922-020

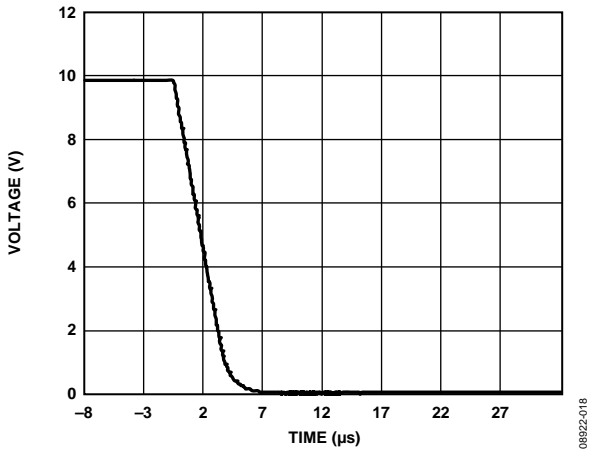

Figure 18. Full-Scale Negative Step

08922-018

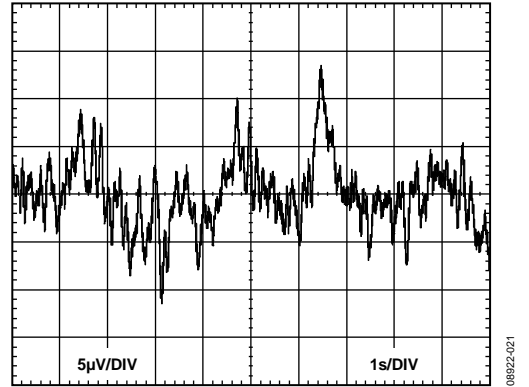

Figure 21. Peak-to-Peak Noise (0.1 Hz to 10 Hz Bandwidth)

08922-021

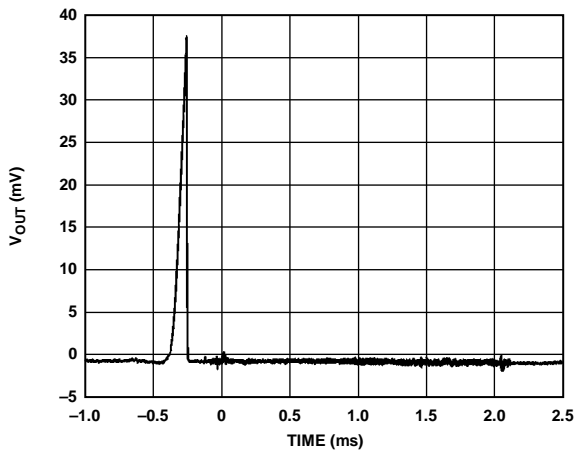

Figure 19. V_{OUT} vs. Time on Power-Up, Load = $2\text{ k}\Omega \parallel 200\text{ pF}$

08922-019

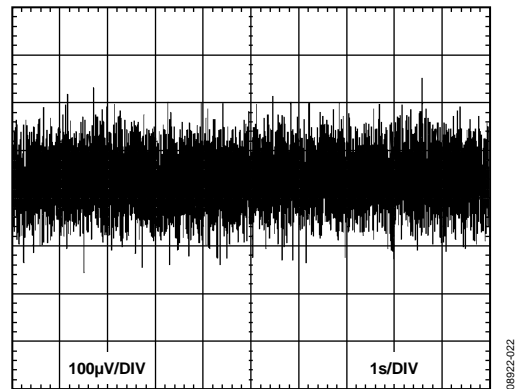

Figure 22. Peak-to-Peak Noise (100 kHz Bandwidth)

08922-022

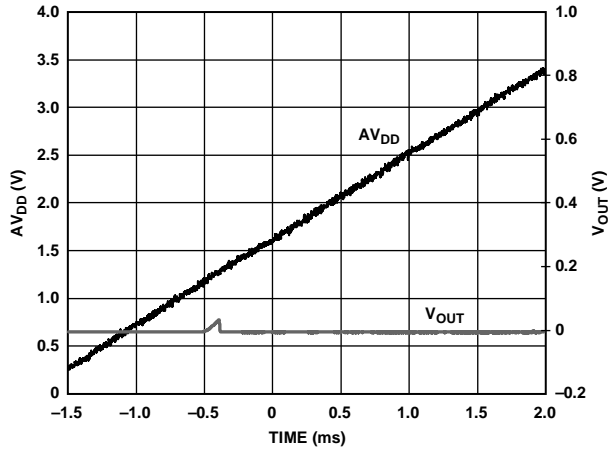

Figure 23. V_{DD} and V_{OUT} vs. Time on Power-Up

06922-023

CURRENT OUTPUT

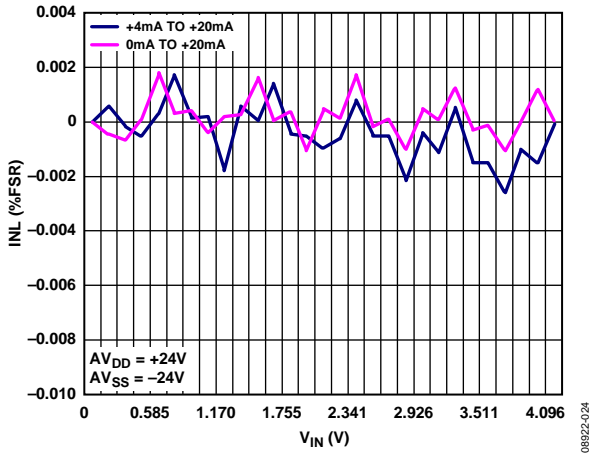

Figure 24. Integral Nonlinearity Error vs. V_{IN} , External R_{SET} Resistor

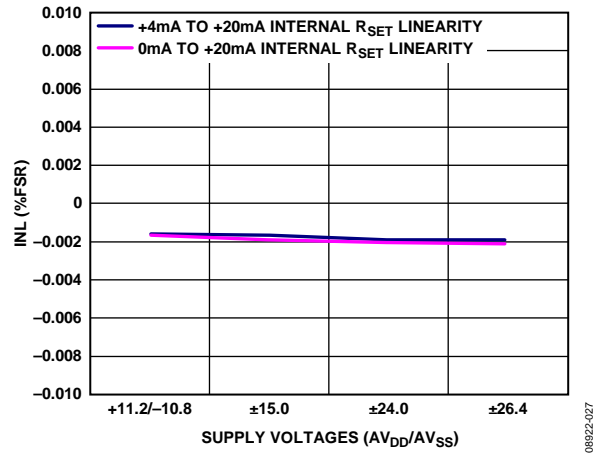

Figure 27. Integral Nonlinearity Error Current Mode, Internal R_{SET} Sense Resistor

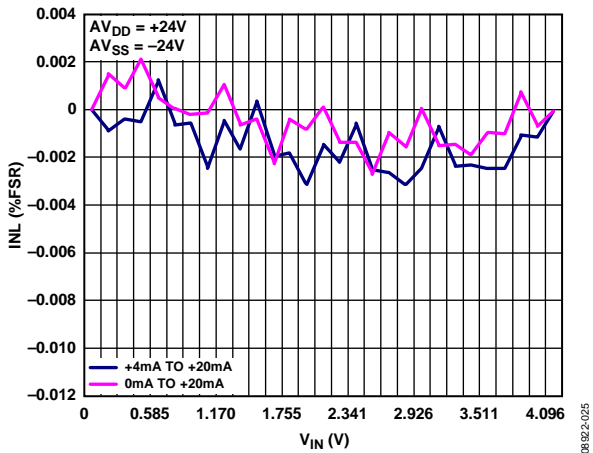

Figure 25. Integral Nonlinearity Error vs. V_{IN} , Internal R_{SET} Resistor

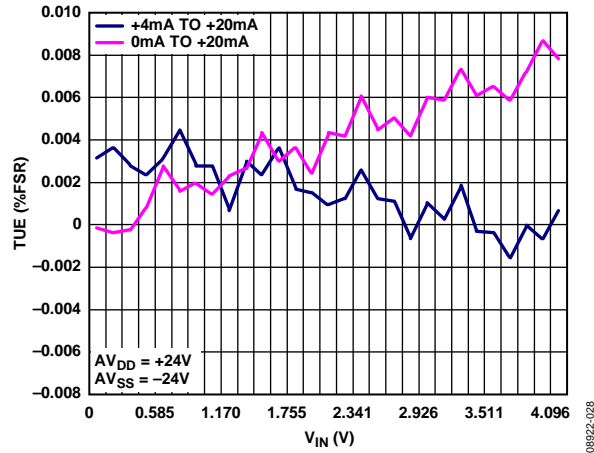

Figure 28. Total Unadjusted Error vs. V_{IN} , External R_{SET} Resistor

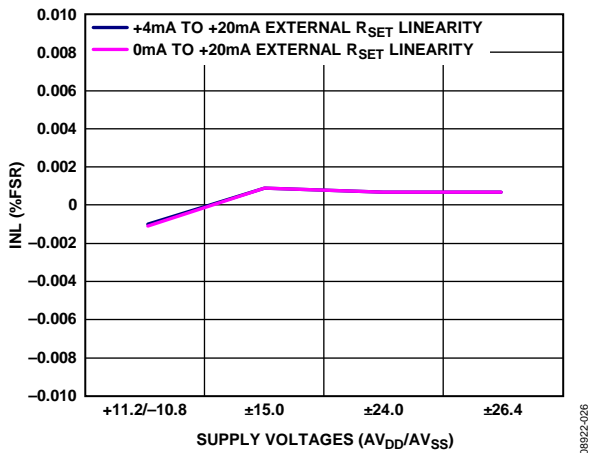

Figure 26. Integral Nonlinearity Error, Current Mode, External R_{SET} Sense Resistor

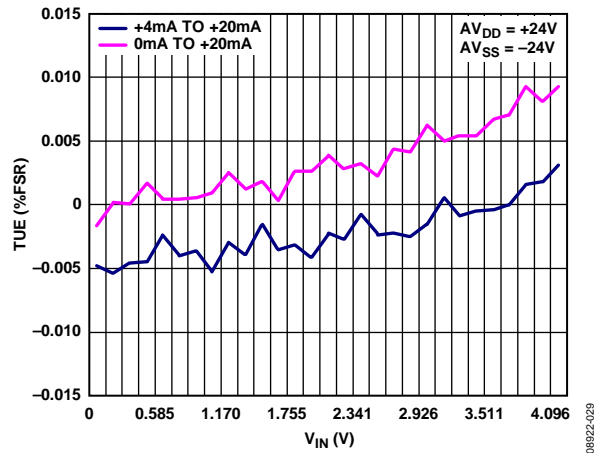

Figure 29. Total Unadjusted Error vs. V_{IN} , Internal R_{SET} Resistor

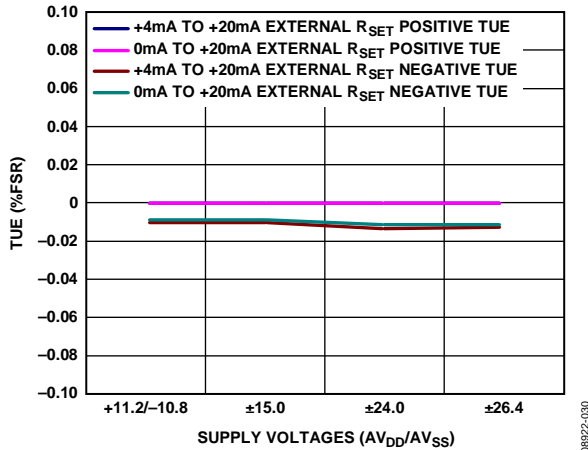

Figure 30. Total Unadjusted Error Current Mode, External R_{SET} Sense Resistor

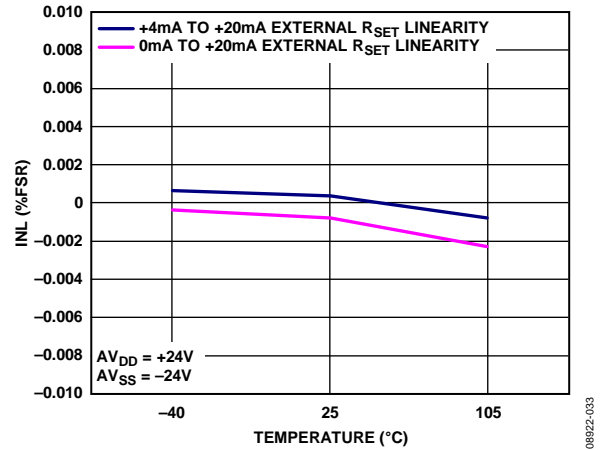

Figure 33. INL vs. Temperature, External R_{SET} Sense Resistor

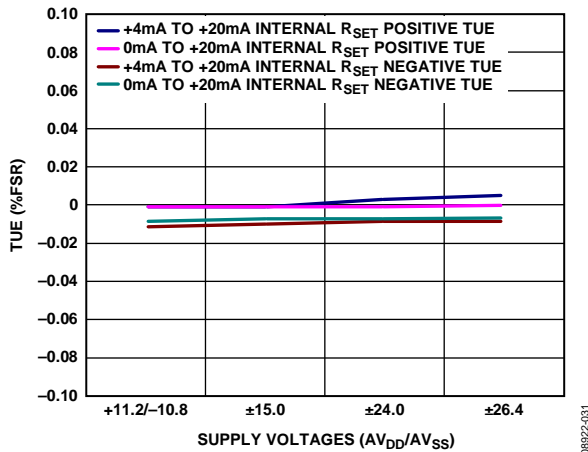

Figure 31. Total Unadjusted Error Current Mode, Internal R_{SET} Sense Resistor

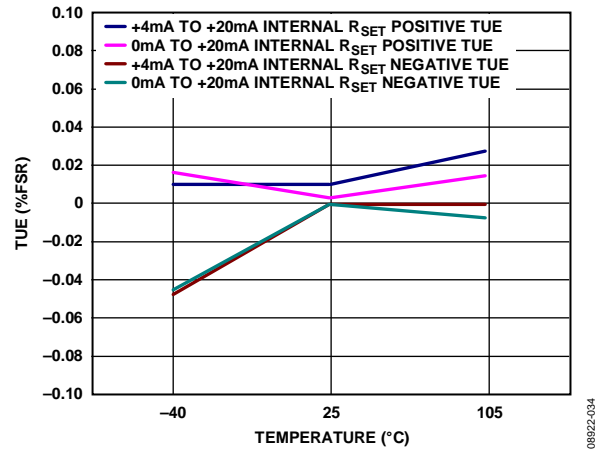

Figure 34. Total Unadjusted Error vs. Temperature, Internal R_{SET} Sense Resistor

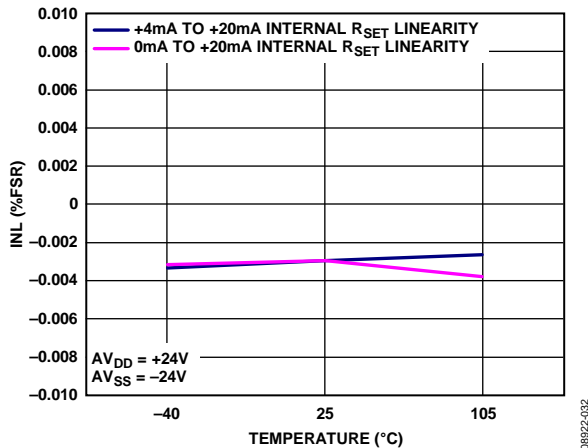

Figure 32. INL vs. Temperature, Internal R_{SET} Sense Resistor

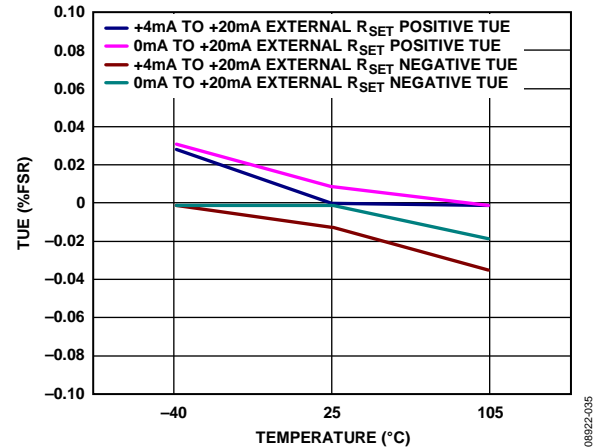

Figure 35. Total Unadjusted Error vs. Temperature, External R_{SET} Sense Resistor

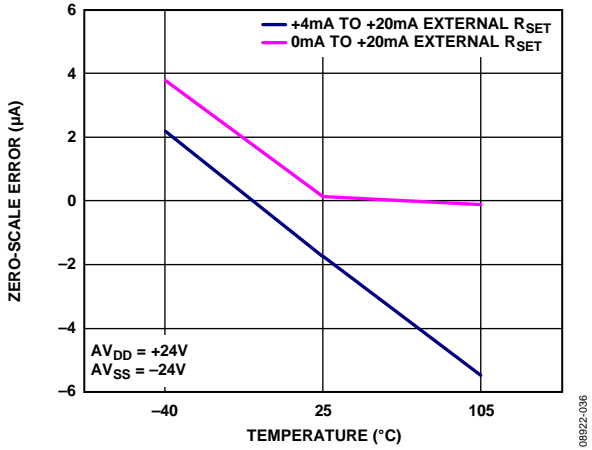

Figure 36. Zero-Scale Error vs. Temperature, External RSET Sense Resistor

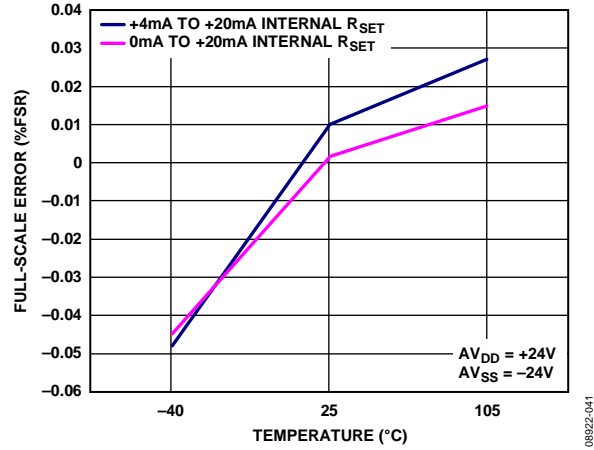

Figure 39. Full-Scale Error vs. Temperature, Internal RSET Sense Resistor

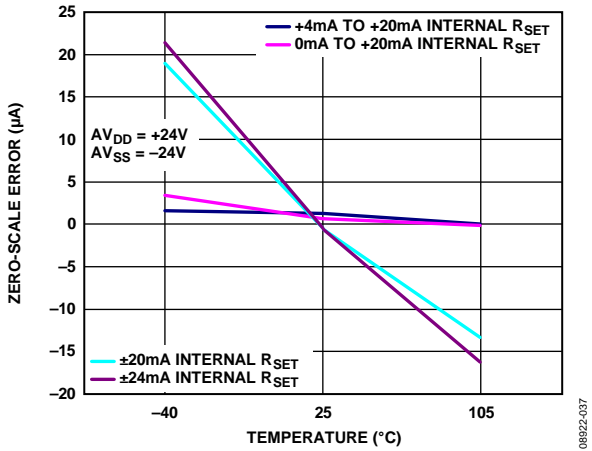

Figure 37. Zero-Scale Error vs. Temperature, Internal RSET Sense Resistor

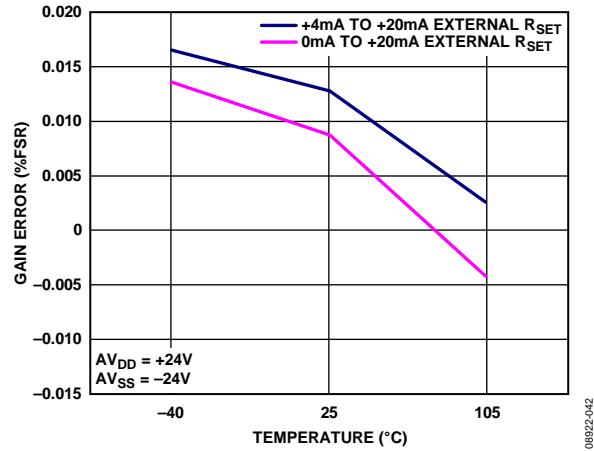

Figure 40. Gain Error vs. Temperature, External RSET Sense Resistor

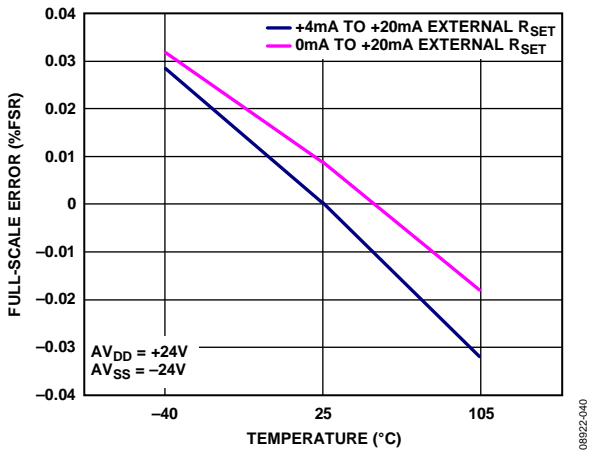

Figure 38. Full-Scale Error vs. Temperature, External RSET Sense Resistor

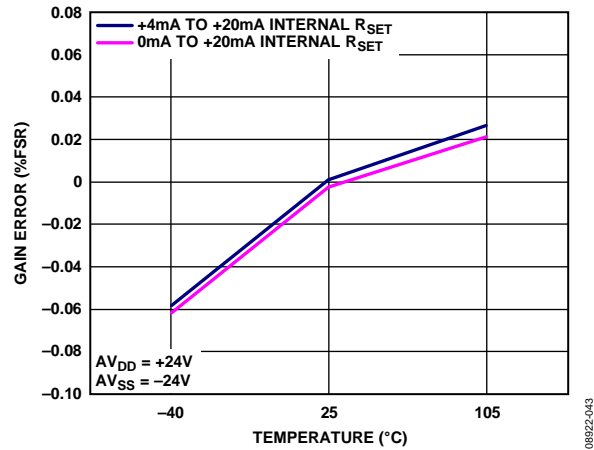

Figure 41. Gain Error vs. Temperature, Internal RSET Sense Resistor

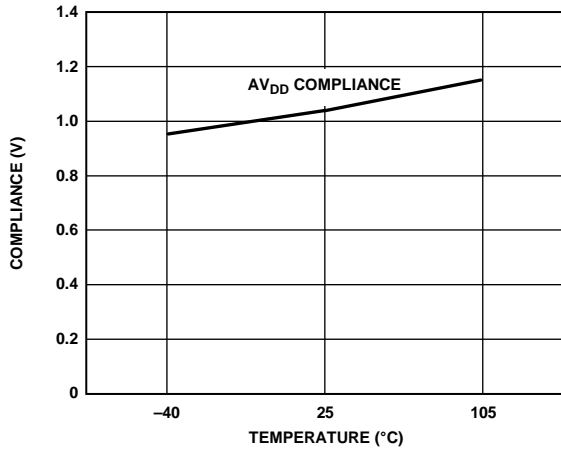

Figure 42. Output Compliance vs. Temperature Tested When $I_{OUT} = 10.8 \text{ mA}$

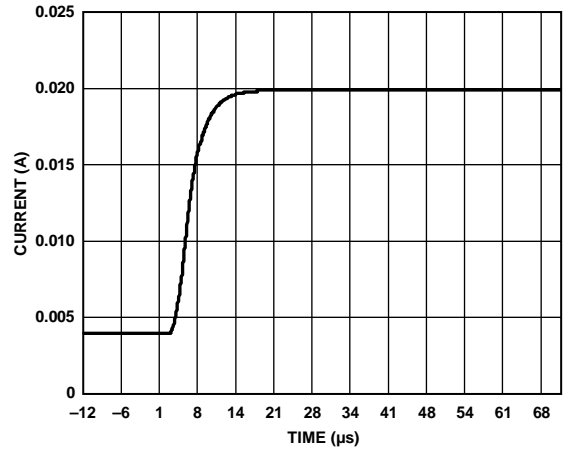

Figure 45. 4 mA to 20 mA Output Current Step

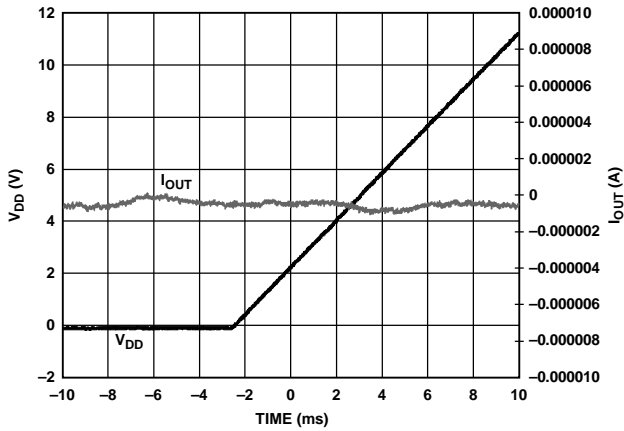

Figure 43. Output Current vs. Time on Power-Up

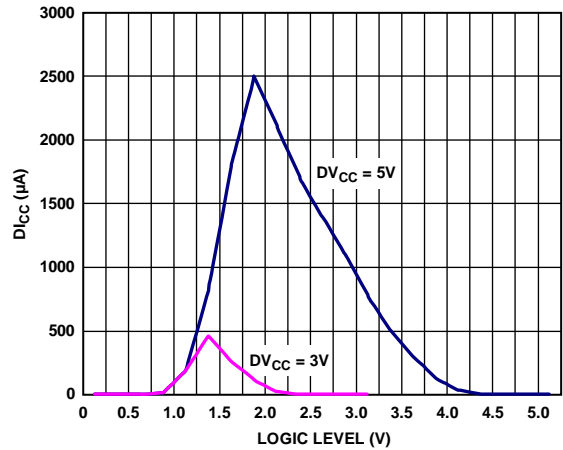

Figure 46. $D_{I_{CC}}$ vs. Logic Input Voltage

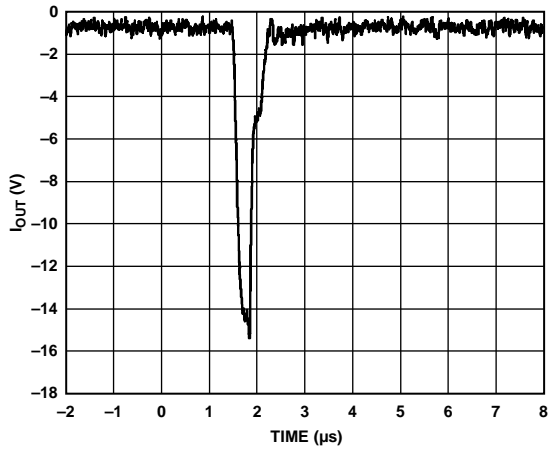

Figure 44. Output Current vs. Time on Output Enable

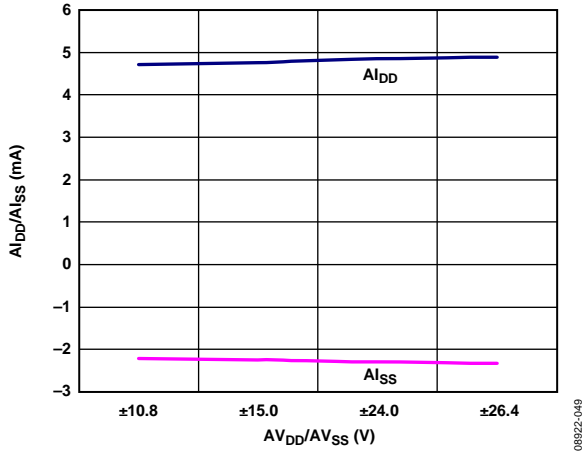

Figure 47. I_{DD}/I_{SS} vs. V_{DD}/V_{SS} , $V_{OUT} = 0$ V

08922-049

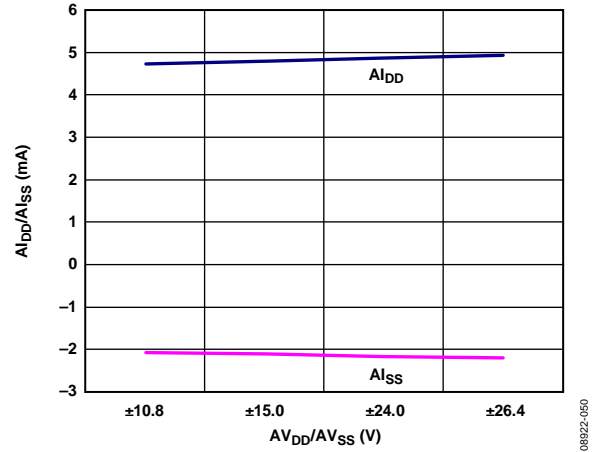

Figure 48. I_{DD}/I_{SS} vs. V_{DD}/V_{SS} , $I_{OUT} = 0$ mA

08922-050

TERMINOLOGY

Total Unadjusted Error (TUE)

TUE is a measure of the output error taking all the various errors into account: INL error, offset error, gain error, and output drift over supplies, temperature, and time. TUE is expressed as a percentage of full-scale range (% FSR).

Relative Accuracy or Integral Nonlinearity (INL)

INL is a measure of the maximum deviation, in % FSR, from a straight line passing through the endpoints of the output driver transfer function. A typical INL vs. input voltage plot can be seen in Figure 5.

Bipolar Zero Error

Bipolar zero error is the deviation of the actual vs. ideal half-scale output of 0 V/0 mA with a bipolar range selected. A plot of bipolar zero error vs. temperature can be seen in Figure 10.

Bipolar Zero TC

Bipolar zero TC is a measure of the change in the bipolar zero error with a change in temperature. It is expressed in ppm FSR/°C.

Full-Scale Error

Full-scale error is the deviation of the actual full-scale analog output from the ideal full-scale output. Full-scale error is expressed as a percentage of full-scale range (% FSR).

Full-Scale TC

Full-scale TC is a measure of the change in the full-scale error with a change in temperature. It is expressed in ppm FSR/°C.

Gain Error

Gain error is a measure of the span error of the output. It is the deviation in slope of the output transfer characteristic from the ideal expressed in % FSR. A plot of gain error vs. temperature can be seen in Figure 11.

Gain Error TC

Gain error TC is a measure of the change in gain error with changes in temperature. Gain error TC is expressed in ppm FSR/°C.

Zero-Scale Error

Zero-scale error is the deviation of the actual zero-scale analog output from the ideal zero-scale output. Zero-scale error is expressed in millivolts (mV).

Zero-Scale TC

Zero-scale TC is a measure of the change in zero-scale error with a change in temperature. Zero-scale error TC is expressed in ppm FSR/°C.

Offset Error

Offset error is a measurement of the difference between VOUT (actual) and VOUT (ideal) expressed in millivolts (mV) in the linear region of the transfer function. It can be negative or positive.

Output Voltage Settling Time

Output voltage settling time is the amount of time it takes for the output to settle to a specified level for a half-scale input change.

Slew Rate

The slew rate of a device is a limitation in the rate of change of the output voltage. The output slewing speed is usually limited by the slew rate of the amplifier used at its output. Slew rate is measured from 10% to 90% of the output signal and is expressed in V/μs.

Current Loop Voltage Compliance

Current loop voltage compliance is the maximum voltage at the IOUT pin for which the output current is equal to the programmed value.

Power-On Glitch Energy

Power-on glitch energy is the impulse injected into the analog output when the AD5748 is powered on. It is specified as the area of the glitch in nV-sec.

Power Supply Rejection Ratio (PSRR)

PSRR indicates how the output is affected by changes in the power supply voltage.

THEORY OF OPERATION

The AD5748 is a single-channel, precision, voltage/current output driver with hardware or software programmable output ranges. The software ranges are configured via an SPI-/MICROWIRE-compatible serial interface. The analog input to the AD5748 is provided from a low voltage, single-supply, digital-to-analog converter and is internally conditioned to provide the desired output current/voltage range. The analog input range is 0 V to 4.096 V.

The output current range is programmable across two current ranges: 4 mA to 21 mA and 0 mA to 21 mA.

The voltage output is provided from a separate pin that can be configured to provide 0 V to 5 V, 0 V to 10.5 V, or ± 10.5 V output ranges. The current and voltage outputs are available on separate pins. Only one output can be enabled at one time. The output range is selected by programming the R3 to R0 bits in the control register (see Table 6 and Table 7).

Figure 49 and Figure 50 show a typical configuration of the AD5748 in software mode and in hardware mode, respectively, in an output module system. The HW SELECT pin selects whether the part is configured in software or hardware mode. The analog input to the AD5748 is provided from a low voltage, single-supply, digital-to-analog converter (DAC) such as the AD506x or AD566x, which provides an output range of 0 V to 4.096 V. The supply and reference for the DAC, as well as the reference for the AD5748, can be supplied from a reference such as the ADR392. The AD5748 can operate from supplies up to ± 26.4 V.

SOFTWARE MODE

In current mode, software-selectable output ranges include 0 mA to 21 mA, and 4 mA to 21 mA.

In voltage mode, software-selectable output ranges include 0 V to 5 V, 0 V to 10.5 V, and ± 10.5 V.

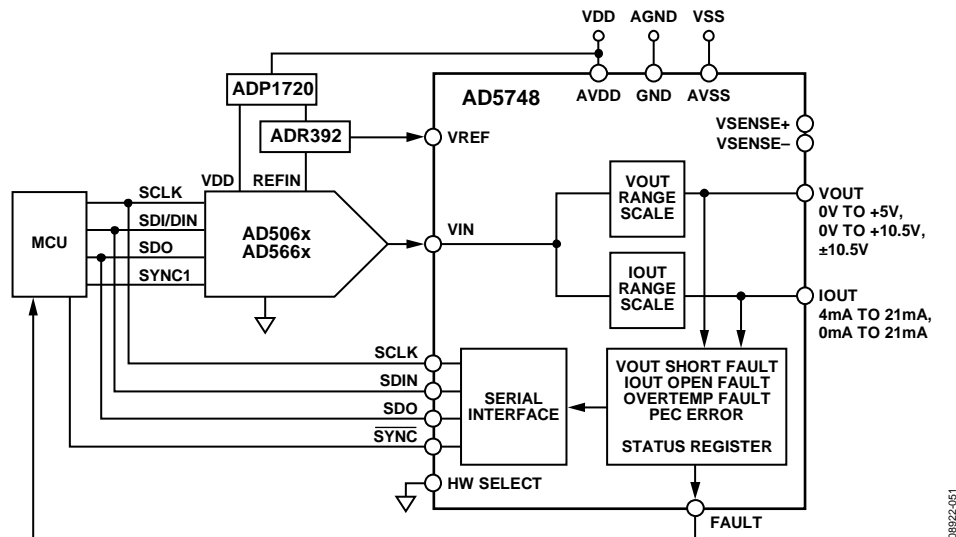

Figure 49. Typical System Configuration in Software Mode (Pull-Up Resistors Not Shown for Open-Drain Outputs)

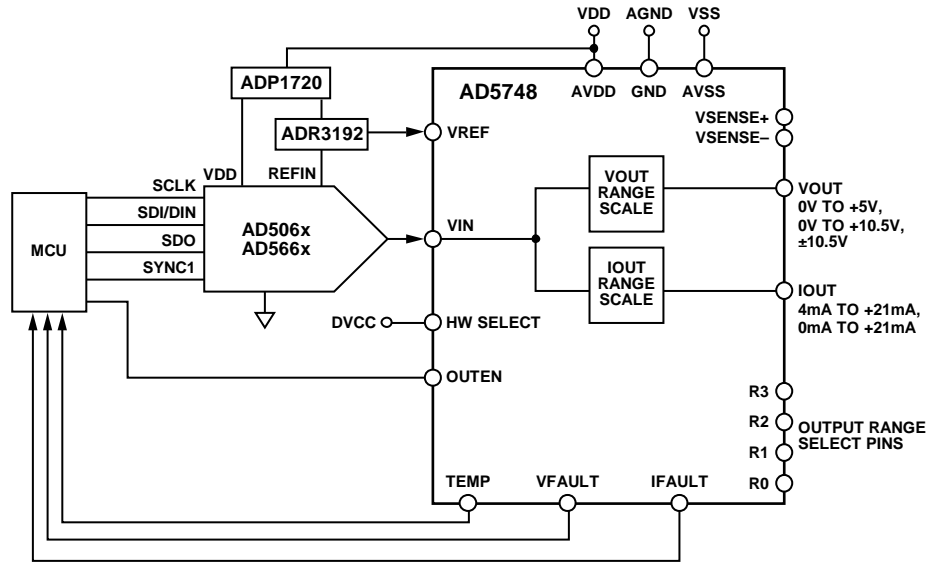

Figure 50. Typical System Configuration in Hardware Mode Using Internal DAC Reference (Pull-Up Resistors Not Shown for Open-Drain Outputs)

Table 5. Suggested Parts for Use with AD5748

DAC	Reference	Power	Accuracy	Description
AD5660	Internal	ADP1720 ¹	12-bit INL	Mid end system, single channel, internal reference
AD5664R	Internal	N/A	N/A	Mid end system, quad channel, internal reference
AD5668	Internal	N/A	N/A	Mid end system, octal channel, internal reference
AD5060	ADR434	ADP1720	16-bit INL	High end system, single channel, external reference
AD5064	ADR434	N/A	N/A	High end system, quad channel, external reference
AD5662	ADR392 ²	ADR392 ²	12-bit INL	Mid end system, single channel, external reference
AD5664	ADR392 ²	N/A	N/A	Mid end system, quad channel, external reference

¹ ADP1720 input range up to 28 V.

² ADR392 input range up to 15 V.

CURRENT OUTPUT ARCHITECTURE

The voltage input from the analog input VIN pin (0 V to 4.096 V) is either converted to a current (see Figure 51), which is then mirrored to the supply rail so that the application simply sees a current source output with respect to an internal reference voltage, or buffered and scaled to output a software-selectable unipolar or bipolar voltage range (see Figure 52). The reference is used to provide internal offsets for range and gain scaling. The selectable output range is programmable through the digital interface.

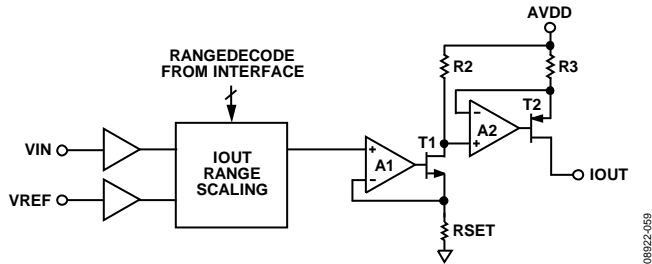

Figure 51. Current Output Configuration

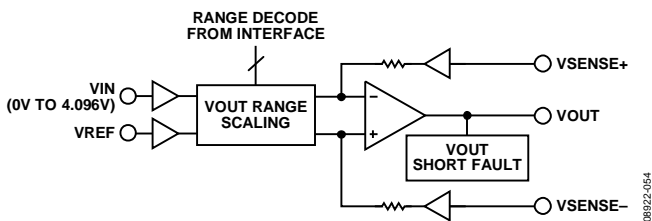

Figure 52. Voltage Output

DRIVING INDUCTIVE LOADS

When driving inductive or poorly defined loads, connect a 0.01 μF capacitor between IOUT and GND. This ensures stability with loads beyond 50 mH. There is no maximum capacitance limit. The capacitive component of the load may cause slower settling.

Voltage Output Amplifier

The voltage output amplifier is capable of generating both unipolar and bipolar output voltages. It is capable of driving a load of 1 k Ω in parallel with 1.2 μF (with an external compensation capacitor on the COMP1 and COMP2 pins). The source and sink capabilities of the output amplifier can be seen in Figure 16. The slew rate is 2 V/ μs .

Internal to the device, there is a 2.5 M Ω resistor connected between the VOUT and VSENSE+ pins and similarly between the VSENSE- pin and the internal device ground. Should a fault condition occur, these resistors act to protect the AD5748 by ensuring that the amplifier loop is closed so that the part does not enter into an open-loop condition.

The VSENSE- pin can work in a common-mode range of ± 3 V with respect to the remote load ground point.

The current and voltage are output on separate pins and cannot be output simultaneously. This allows the user to tie both the current and voltage output pins together and configure the end system as a single-channel output.

Driving Large Capacitive Loads

The voltage output amplifier is capable of driving capacitive loads of up to 1 μF with the addition of a nonpolarized compensation capacitor between the COMP1 and COMP2 pins.

Without the compensation capacitor, up to 20 nF capacitive loads can be driven. Care should be taken to choose an appropriate value for the C_{COMP} capacitor. This capacitor, while allowing the AD5748 to drive higher capacitive loads and reduce overshoot, increases the settling time of the part and, therefore, affects the bandwidth of the system. Considered values of this capacitor should be in the range 100 pF to 4 nF depending on the trade-off required between settling time, overshoot, and bandwidth.

POWER-ON STATE OF THE AD5748

On power-up, the AD5748 senses whether hardware or software mode is loaded and sets the power-up conditions accordingly.

In software SPI mode, the power-up state of the output is dependent on the state of the CLEAR pin. If the CLEAR pin is pulled high, then the part powers up, driving an active 0 V on the output. If the CLEAR pin is pulled low, then the part powers up with the voltage output channel in tristate mode. In both cases, the current output channel powers up in a tristate condition (0 mA). This allows the voltage and current outputs to be connected together if desired.

To put the part into normal operation, the user must set the OUTEN bit in the control register to enable the output and, in the same write, set the output range configuration using the R3 to R0 range bits. If the CLEAR pin is still high (active) during this write, the part automatically clears to its normal clear state as defined by the programmed range and by the CLRSEL pin or CLRSEL bit (see the Asynchronous Clear (CLEAR) section for more details). The CLEAR pin must be taken low to operate the part in normal mode.

The CLEAR pin is typically driven directly from a microcontroller. In cases where the power supply for the AD5748 supply may be independent of the microcontroller power supply, the user can connect a weak pull-up resistor to DVCC or a pull-down resistor to ground to ensure that the correct power-up condition is achieved independent of the microcontroller. A 10 k Ω pull-up/pull-down resistor on the CLEAR pin should be sufficient for most applications.

If hardware mode is selected, the part powers up to the conditions defined by the R3 to R0 range bits and the status of the OUTEN or CLEAR pin. It is recommended to keep the output disabled when powering up the part in hardware mode.

DEFAULT REGISTERS AT POWER-ON

The AD5748 power-on reset circuit ensures that all registers are loaded with zero code.

In software SPI mode, the part powers up with all outputs disabled (OUTEN bit = 0). The user must set the OUTEN bit in the control register to enable the output and, in the same write, set the output range configuration using the R3 to R0 bits.

If hardware mode is selected, the part powers up to the conditions defined by the R3 to R0 bits and the status of the OUTEN pin. It is recommended to keep the output disabled when powering up the part in hardware mode.

RESET FUNCTION

In software mode, the part can be reset using the $\overline{\text{RESET}}$ pin (active low) or the reset bit (reset = 1). A reset disables both the current and voltage outputs to their power-on condition. The user must write to the OUTEN bit to enable the output and, in the same write, set the output range configuration. The $\overline{\text{RESET}}$ pin is a level-sensitive input; the part stays in reset mode as long as the $\overline{\text{RESET}}$ pin is low. The reset bit clears to 0 following a reset command to the control register.

In hardware mode, there is no reset. If using the part in hardware mode, the $\overline{\text{RESET}}$ pin should be tied high.

OUTEN

In software mode, the output can be enabled or disabled using the OUTEN bit in the control register. When the output is

disabled, both the current and voltage channels go into tristate. The user must set the OUTEN bit to enable the output and simultaneously set the output range configuration.

In hardware mode, the output can be enabled or disabled using the OUTEN pin. When the output is disabled, both the current and voltage channels both go into tristate. The user must write to the OUTEN pin to enable the output. It is recommended that the output be disabled when changing the ranges.

SOFTWARE CONTROL

Software control is enabled by connecting the HW SELECT pin to ground. In software mode, the AD5748 is controlled over a versatile 3-wire serial interface that operates at clock rates of up to 50 MHz. It is compatible with SPI, QSPI™, MICROWIRE, and DSP standards.

Input Shift Register

The input shift register is 16 bits wide. Data is loaded into the device MSB first as a 16-bit word under the control of a serial clock input, SCLK. Data is clocked in on the falling edge of SCLK. The input shift register consists of 16 control bits, as shown in Table 6. The timing diagram for this write operation is shown in Figure 2. The first three bits of the input shift register are used to set the hardware address of the AD5748 device on the printed circuit board (PCB). Up to eight devices can be addressed per board.

Bit D11, Bit D1, and Bit D0 must always be set to 0 during any write sequence.

Table 6. Input Shift Register Contents for a Write Operation—Control Register

MSB														LSB	
D15	D14	D13	D12	D11	D10	D9	D8	D7	D6	D5	D4	D3	D2	D1	D0
A2	A1	A0	R/W	0	R3	R2	R1	R0	CLRSEL	OUTEN	Clear	RSET	Reset	0	0

Table 7. Input Shift Register Descriptions

Bit	Description			
A2, A1, A0	Used in association with the AD2, AD1, and AD0 external pins to determine which part is being addressed by the system controller			
	A2	A1	A0	Function
	0	0	0	Addresses part with Pin AD2 = 0, Pin AD1 = 0, Pin AD0 = 0
	0	0	1	Addresses part with Pin AD2 = 0, Pin AD1 = 0, Pin AD0 = 1
	0	1	0	Addresses part with Pin AD2 = 0, Pin AD1 = 1, Pin AD0 = 0
	0	1	1	Addresses part with Pin AD2 = 0, Pin AD1 = 1, Pin AD0 = 1
	1	0	0	Addresses part with Pin AD2 = 1, Pin AD1 = 0, Pin AD0 = 0
	1	0	1	Addresses part with Pin AD2 = 1, Pin AD1 = 0, Pin AD0 = 1
	1	1	0	Addresses part with Pin AD2 = 1, Pin AD1 = 1, Pin AD0 = 0
	1	1	1	Addresses part with Pin AD2 = 1, Pin AD1 = 1, Pin AD0 = 1
R/W	Indicates a read from or a write to the addressed register			

AD5748

Bit	Description					
R3, R2, R1, R0	Selects output configuration in conjunction with RSET					
	RSET	R3	R2	R1	R0	Output Configuration
	0	0	0	0	0	4 mA to 21 mA (external 15 kΩ current sense resistor)
	0	0	0	0	1	0 mA to 21 mA (external 15 kΩ current sense resistor)
	0	0	0	1	0	N/A
	0	0	0	1	1	N/A
	0	0	1	0	0	N/A
	0	0	1	0	1	0 V to 5 V
	0	0	1	1	0	N/A
	0	0	1	1	1	N/A
	0	1	0	0	0	N/A
	0	1	0	0	1	N/A
	0	1	0	1	0	0 V to 10.5 V
	0	1	0	1	1	N/A
	0	1	1	0	0	±10.5 V
	0	1	1	0	1	N/A
	0	1	1	1	0	N/A
	0	1	1	1	1	N/A
	1	0	0	0	0	4 mA to 21 mA (internal current sense resistor)
	1	0	0	0	1	0 mA to 21 mA (internal current sense resistor)
	1	0	0	1	0	N/A
	1	0	0	1	1	N/A
	1	0	1	0	0	N/A
	1	0	1	0	1	0 V to 5 V
	1	0	1	1	0	N/A
	1	0	1	1	1	N/A
	1	1	0	0	0	N/A
	1	1	0	0	1	N/A
	1	1	0	1	0	0 V to 10.5 V
	1	1	0	1	1	N/A
	1	1	1	0	0	±10.5 V
	1	1	1	0	1	N/A
	1	1	1	1	0	N/A
	1	1	1	1	1	N/A
CLRSEL	Sets clear mode to zero scale or midscale. See the Asynchronous Clear (CLEAR) section					
	CLRSEL	Function				
	0	Clear to 0 V				
	1	Clear to midscale in unipolar mode; clear to zero scale in bipolar mode				
OUTEN	Output enable bit. This bit must be set to 1 to enable the outputs					
Clear	Software clear bit, active high					
RSET	Select internal/external current sense resistor					
	RSET	Function				
	1	Select internal current sense resistor; used with the R3 to R0 bits to select range				
	0	Select external current sense resistor; used with the R3 to R0 bits to select range				
Reset	Resets the part to its power-on state					

Readback Operation

Readback mode is activated by selecting the correct device address (A2, A1, A0) and then setting the R/W bit to 1. By default, the SDO pin is disabled. After having addressed the AD5748 for a read operation, setting R/W to 1 enables the SDO pin and SDO data is clocked out on the 5th rising edge of SCLK. After the data has been clocked out on SDO, a rising edge on $\overline{\text{SYNC}}$ disables (tristate) the SDO pin again. Status register data (see Table 8) and control register data are both available during the same read cycle.

The status bits comprise four read-only bits. They are used to notify the user of specific fault conditions that occur, such as an open circuit or short circuit on the output, overtemperature error, or an interface error. If any of these fault conditions occurs, a hardware FAULT is also asserted low, which can be used as a hardware interrupt to the controller.

See the Detailed Description of Features section for a full explanation of fault conditions.

HARDWARE CONTROL

Hardware control is enabled by connecting the HW SELECT pin to DVCC. In this mode, the R3, R2, R1, and R0 pins in conjunction with the RSET pin are used to configure the output range, as per Table 7.

In hardware mode, there is no status register. The fault conditions (open circuit, short circuit, and overtemperature) are available on Pin IFAULT, Pin VFAULT, and Pin TEMP. If any one of these fault conditions is set, then a low is asserted on the specific fault pin. IFAULT, VFAULT, and TEMP are open-drain outputs and, therefore, can be connected together to allow the user to generate one interrupt to the system controller to communicate a fault. If hardwired in this way, it is not possible to isolate which fault occurred in the system.

TRANSFER FUNCTION

The AD5748 consists of an internal signal conditioning block that maps the analog input voltage to a programmed output range. The available analog input range is 0 V to 4.096 V.

For all ranges, both current and voltage, the AD5748 implements a straight linear mapping function. 0 V maps to the lower end of the selected range; 4.096 V maps to the upper end of the selected range.

Table 8. Input Shift Register Contents for a Read Operation—Status Register

MSB														LSB	
D15	D14	D13	D12	D11	D10	D9	D8	D7	D6	D5	D4	D3	D2	D1	D0
A2	A1	A0	1	0	R3	R2	R1	R0	CLRSEL	OUTEN	RSET	PEC error	OVER TEMP	IOUT fault	VOUT fault

Table 9. Status Bit Options

Bit	Description
PEC Error	This bit is set if there is an interface error detected by CRC-8 error checking. See the Detailed Description of Features section.
VOUT Fault	This bit is set if there is a short circuit on the VOUT pin.
IOUT Fault	This bit is set if there is an open circuit on the IOUT pin.
OVER TEMP	This bit is set if the AD5748 core temperature exceeds approximately 150°C.

DETAILED DESCRIPTION OF FEATURES

OUTPUT FAULT ALERT—SOFTWARE MODE

In software mode, the AD5748 is equipped with one FAULT pin; this is an open-drain output allowing several AD5748 devices to be connected together to one pull-up resistor for global fault detection. In software mode, the FAULT pin is forced active low by any one of the following fault scenarios:

- The voltage at IOUT attempts to rise above the compliance range, due to an open-loop circuit or insufficient power supply voltage. The internal circuitry that develops the fault output avoids using a comparator with window limits because this requires an actual output error before the fault output becomes active. Instead, the signal is generated when the internal amplifier in the output stage has less than approximately 1 V of remaining drive capability. Thus, the fault output activates slightly before the compliance limit is reached. Because the comparison is made within the feedback loop of the output amplifier, the output accuracy is maintained by its open-loop gain, and an output error does not occur before the fault output becomes active.
- A short is detected on the voltage output pin (VOUT). The short-circuit current is limited to 15 mA.
- An interface error is detected due to a packet error checking (PEC) failure. See the Packet Error Checking section.
- If the core temperature of the AD5748 exceeds approximately 150°C.

OUTPUT FAULT ALERT—HARDWARE MODE

In hardware mode, the AD5748 is equipped with three fault pins: VFAULT, IFAULT, and TEMP. These are open-drain outputs allowing several AD5748 devices to be connected together to one pull-up resistor for global fault detection. In hardware control mode, these fault pins are forced active by any one of the following fault scenarios:

- Open-circuit detect. The voltage at IOUT attempts to rise above the compliance range, due to an open-loop circuit or insufficient power supply voltage. The internal circuitry that develops the fault output avoids using a comparator with window limits because this requires an actual output error before the fault output becomes active. Instead, the signal is generated when the internal amplifier in the

output stage has less than approximately 1 V of remaining drive capability. Thus, the fault output activates slightly before the compliance limit is reached. Because the comparison is made within the feedback loop of the output amplifier, the output accuracy is maintained by its open-loop gain, and an output error does not occur before the fault output becomes active. If this fault is detected, the IFAULT pin is forced low.

- A short is detected on the voltage output pin (VOUT). The short-circuit current is limited to 15 mA. If this fault is detected, the VFAULT pin is forced low.
- If the core temperature of the AD5748 exceeds approximately 150°C. If this fault is detected, the TEMP pin is forced low.

VOLTAGE OUTPUT SHORT-CIRCUIT PROTECTION

Under normal operation, the voltage output sinks and sources up to 12 mA and maintains the specified operation. The maximum current that the voltage output delivers is 15 mA; this is the short-circuit current.

ASYNCHRONOUS CLEAR (CLEAR)

CLEAR is an active high clear that allows the voltage output to be cleared to either zero-scale code or midscale code and is user-selectable via the CLRSEL pin or the CLRSEL bit of the input shift register, as described in Table 7. (The clear select feature is a logical OR function of the CLRSEL pin and the CLRSEL bit.) The current loop output clears to the bottom of its programmed range. When the CLEAR signal is returned low, the output returns to its programmed value or a new value if programmed. A clear operation can also be performed via the clear command in the control register.

Table 10. CLRSEL Options

CLRSEL	Output Clear Value	
	Unipolar Output Voltage Range	Unipolar Current Output Range
0	0 V	Zero scale; for example: 4 mA on the 4 mA to 21 mA range 0 mA on the 0 mA to 21 mA range
1	Midscale	Midscale; for example: 12.5 mA on the 4 mA to 21 mA range 10.5 mA on the 0 mA to 21 mA range

CURRENT SETTING RESISTOR

Referring to Figure 1, R_{SET} is an internal sense resistor as part of the voltage-to-current conversion circuitry. The nominal value of the internal current sense resistor is 15 k Ω . To allow for over-range capability in current mode, the user can also select the internal current sense resistor to be 14.7 k Ω , giving a nominal 2% overrange capability. This feature is available in the 0 mA to 21 mA and 4 mA to 21 mA current ranges.

The stability of the output current value over temperature is dependent on the stability of the value of R_{SET} . As a method of improving the stability of the output current over temperature, an external low drift resistor can be connected to the REXT1 and REXT2 pins of the AD5748, which can be used instead of the internal resistor. The external resistor is selected via the input shift register. If the external resistor option is not used, the REXT1 and REXT2 pins should be left floating.

PACKET ERROR CHECKING

To verify that data has been received correctly in noisy environments, the AD5748 offers the option of error checking based on an 8-bit (CRC-8) cyclic redundancy check. The device controlling the AD5748 should generate an 8-bit frame check sequence using the following polynomial:

$$C(x) = x_8 + x_2 + x_1 + 1$$

This is added to the end of the data-word, and 24 data bits are sent to the AD5748 before taking SYNC high. If the AD5748 receives a 24-bit data frame, it performs the error check when SYNC goes high. If the check is valid, then the data is written to the selected register. If the error check fails, the FAULT pin goes low and Bit D3 of the status register is set. After reading this register, this error flag is cleared automatically and the FAULT pin goes high again.

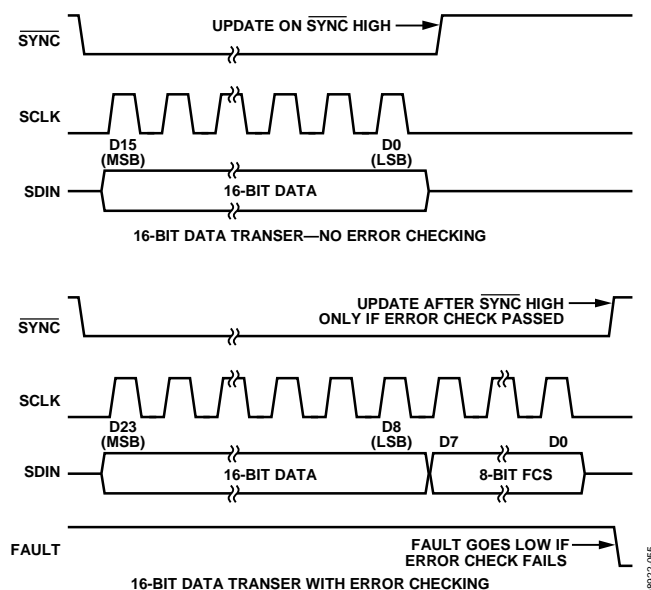

Figure 53. PEC Error Checking Timing

08822-055

APPLICATIONS INFORMATION

TRANSIENT VOLTAGE PROTECTION

The AD5748 contains ESD protection diodes that prevent damage from normal handling. The industrial control environment can, however, subject I/O circuits to much higher transients. To protect the AD5748 from excessively high voltage transients, external power diodes and a surge current limiting resistor may be required, as shown in Figure 54. The constraint on the resistor value is that, during normal operation, the output level at IOOUT must remain within its voltage compliance limit of $AV_{DD} - 2.75$ V, and the two protection diodes and resistor must have appropriate power ratings. Further protection can be added with transient voltage suppressors if needed.

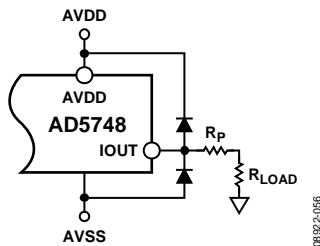

Figure 54. Output Transient Voltage Protection

THERMAL CONSIDERATIONS

It is important to understand the effects of power dissipation on the package and on junction temperature. The internal junction temperature should not exceed 125°C. The AD5748 is packaged in a 32-lead LFCSP 5, 5 mm × 5 mm package. The thermal impedance, θ_{JA} , is 28°C/W. It is important that the devices are not operated under conditions that cause the junction temperature to exceed its junction temperature.

Worst-case conditions occur when the AD5748 is operated from the maximum AV_{DD} (26.4 V) while driving the maximum current (24 mA) directly to ground. The quiescent current of the AD5748 should also be taken into account, nominally ~4 mA.

The following calculations estimate maximum power dissipation under these worst-case conditions, and determine maximum ambient temperature based on the power dissipation:

$$\text{Power Dissipation} = 26.4 \text{ V} \times 28 \text{ mA} = 0.7392 \text{ W}$$

$$\text{Temp Increase} = 28^\circ\text{C} \times 0.7392 \text{ W} = 20.7^\circ\text{C}$$

$$\text{Maximum Ambient Temp} = 125^\circ\text{C} - 20.7^\circ\text{C} = 104.3^\circ\text{C}$$

These figures assume that proper layout and grounding techniques are followed to minimize power dissipation, as outlined in the Layout Guidelines section.

LAYOUT GUIDELINES

In any circuit where accuracy is important, careful consideration of the power supply and ground return layout helps to ensure the rated performance. The PCB on which the AD5748 is mounted should be designed so that the AD5748 lies on the analog plane.

The AD5748 should have ample supply bypassing of 10 μF in parallel with 0.1 μF on each supply located as close to the package as possible, ideally right up against the device. The 10 μF capacitors are the tantalum bead type. The 0.1 μF capacitor should have low effective series resistance (ESR) and low effective series inductance (ESI) such as the common ceramic types, which provide a low impedance path to ground at high frequencies to handle transient currents due to internal logic switching.

In systems where there are many devices on one board, it is often useful to provide some heat sinking capability to allow the power to dissipate easily.

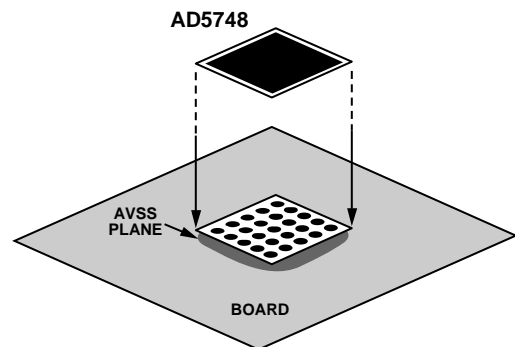

Figure 55. Paddle Connection to Board

The AD5748 has an exposed paddle beneath the device. This paddle is connected to the AVSS supply for the part. For optimum performance, special considerations should be used to design the motherboard and to mount the package. For enhanced thermal, electrical, and board level performance, the exposed paddle on the bottom of the package is soldered to the corresponding thermal land paddle on the PCB. Thermal vias are designed into the PCB land paddle area to further improve heat dissipation.

The AVSS plane on the device can be increased (as shown in Figure 55) to provide a natural heat sinking effect.

GALVANICALLY ISOLATED INTERFACE

In many process control applications, it is necessary to provide an isolation barrier between the controller and the unit being controlled to protect and isolate the controlling circuitry from any hazardous common-mode voltages that may occur. The *iCoupler*[®] family of products from Analog Devices, Inc., provides voltage isolation in excess of 5.0 kV. The serial loading structure of the AD5748 makes it ideal for isolated interfaces because the number of interface lines is kept to a minimum. Figure 56 shows a 4-channel isolated interface using an ADuM1400. For further information, visit www.analog.com/icouplers.

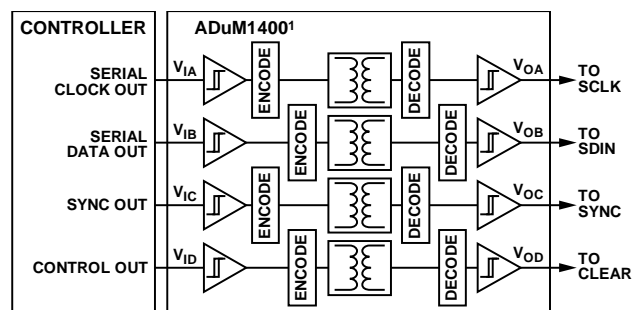

¹ADDITIONAL PINS OMITTED FOR CLARITY.

Figure 56. Isolated Interface

08922-058

MICROPROCESSOR INTERFACING

Microprocessor interfacing to the AD5748 is via a serial bus that uses a protocol compatible with microcontrollers and DSP processors. The communications channel is a 3-wire (minimum) interface consisting of a clock signal, a data signal, and a SYNC signal. The AD5748 requires a 16-bit data-word with data valid on the falling edge of SCLK.

OUTLINE DIMENSIONS

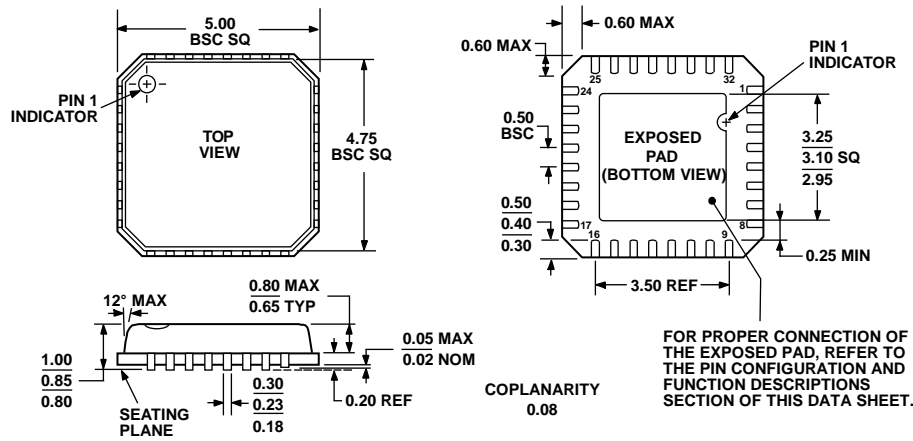

COMPLIANT TO JEDEC STANDARDS MO-220-VHHD-2

Figure 57. 32-Lead Lead Frame Chip Scale Package [LFCSP_VQ]
 5 mm × 5 mm Body, Very Thin Quad
 (CP-32-2)
 Dimensions shown in millimeters

011708-A

ORDERING GUIDE

Model ¹	TUE Accuracy	Analog Input Range	External Reference	Temperature Range	Package Description	Package Option
AD5748ACPZ	±0.3% V _{OUT} , ±0.5% I _{OUT}	0 V to 4.096 V	4.096 V	−40°C to +105°C	32-Lead LFCSP_VQ	CP-32-2
AD5748ACPZ-RL7	±0.3% V _{OUT} , ±0.5% I _{OUT}	0 V to 4.096 V	4.096 V	−40°C to +105°C	32-Lead LFCSP_VQ	CP-32-2

¹ Z = RoHS Compliant Part.