

Appendix

Package Drawings and Specifications

Package Drawing – SOIC8

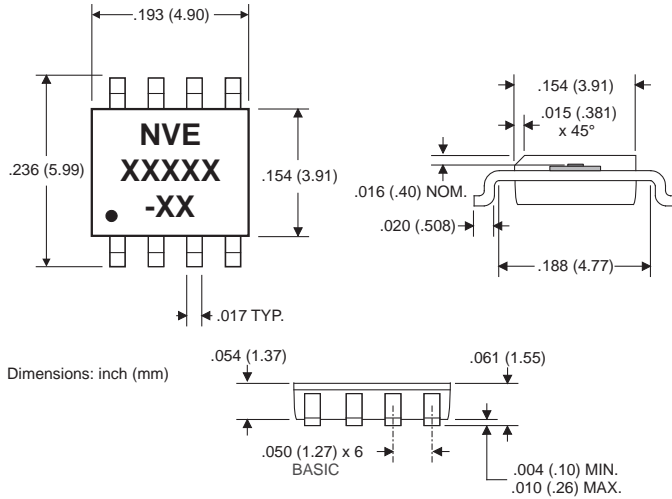

Note: SOIC8 Package has thermal power dissipation of 240°C/Watt in free air. Attaching the package to a circuit board improves thermal performance.

Package Drawing – MSOP8

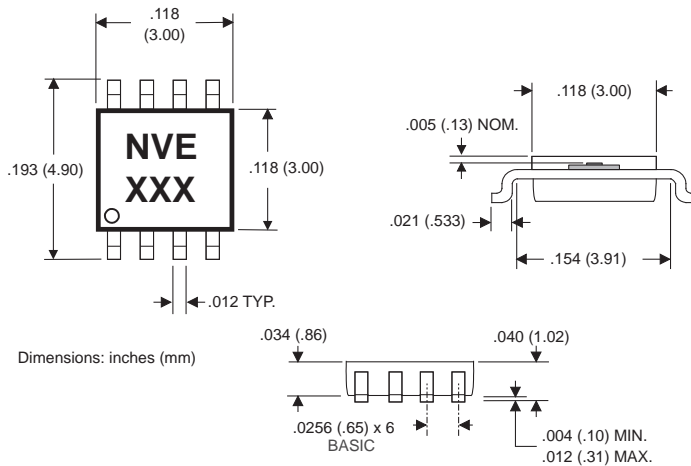

Note: MSOP8 Package has thermal power dissipation of 320°C/Watt in free air. Attaching the package to a circuit board improves thermal performance.

Package Drawing – TDFN6 2.5 mm x 2.5 mm

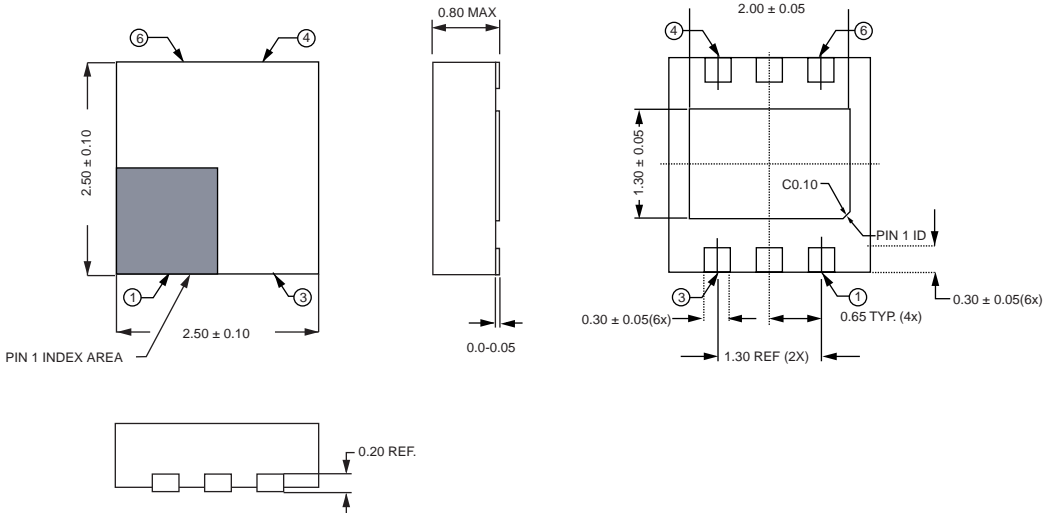

Note: Dimensions in mm. TDFN6 package has thermal power dissipation of 320°C/Watt in free air. Attaching the package to a circuit board improves thermal performance.

Package Drawing – TDFN SO8

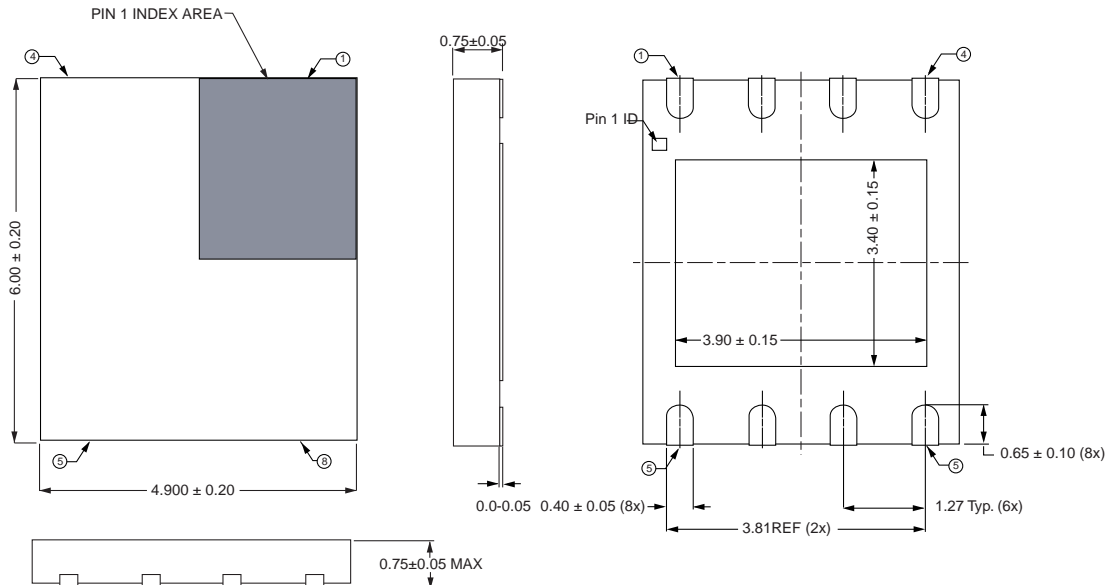

Note: Dimensions in mm. TDFN SO8 Package has thermal power dissipation of 240°C/Watt in free air. Attaching the package to a circuit board improves thermal performance.

Package Drawing – PLLP6 3.0 mm x 3.0 mm

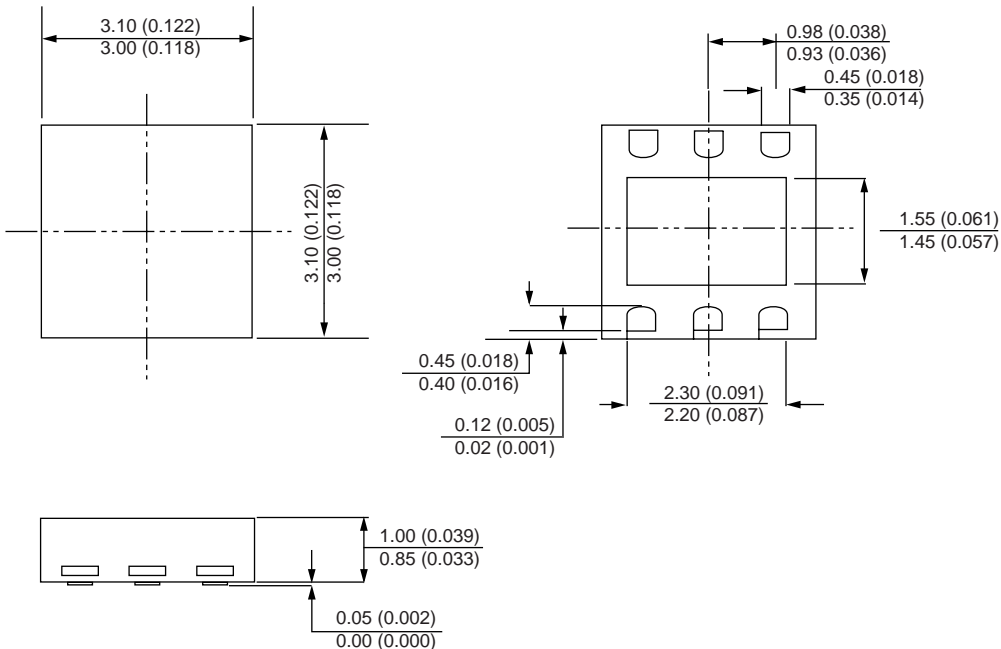

Note: The PLLP6 package has thermal power dissipation of 320°C/Watt in free air. Attaching the package to a circuit board improves thermal performance. Dimensions are in mm (inches).

Note on Lead-Free Packages

The electronics industry has been working to provide lead-free products in response to concerns about the environmental impact of the use of lead (Pb) in solder finishes. Increasing customer demand and directives to decrease the amounts of lead in consumer electronics products from governments around the globe, drives this effort.

Lead-free finishes utilizing pure tin (Sn) have already been qualified at NVE and are available in most of our products. However, additional lead times are associated with these parts.

Since most lead-free solders being used in board assembly environments have higher melting temperatures than traditional tin-lead solders, higher reflow temperatures may be necessary to form an equivalent solder joint between the component and the PC board. NVE characterizes all lead-free packages using elevated temperature (245°C to 260°C) reflow profiles characteristic of lead-free board assembly environments. All lead-free products will be identified with an “E” suffix on the part number and a lower case “e” marking on the package.

This lead-free transition is an important component of NVE’s commitment to take an active part in protecting the environment and our responsibility to our customers and the communities around the world in which we do business. We remain dedicated to meeting our customers’ requirements and expectations.

Recommended Solder Reflow Profile

NVE recommends the following soldering profile:

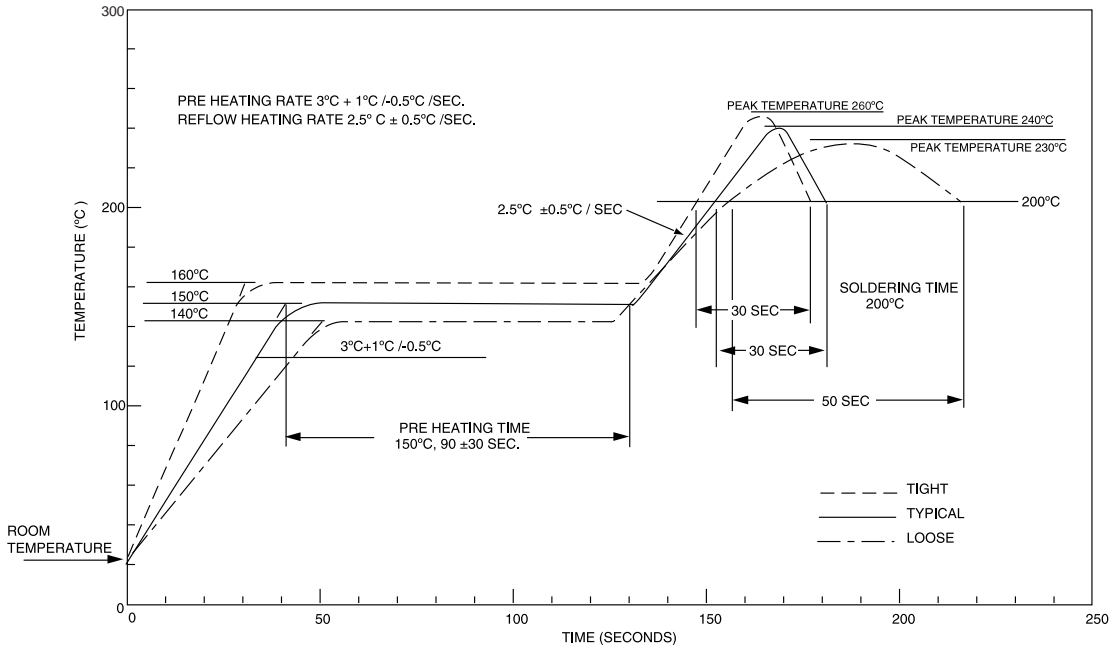

For leaded (Pb) parts, the peak temperature shown in this profile can be decreased to as low as 230°C.

Exceeding 265°C at peak or the time at peak temperature shown in this profile can damage the parts. Specifically:

1. AA- and AD-Series sensors are rated at 150°C maximum storage temperature. They can withstand the solder profile shown above with no harmful effects. However, temperatures above 265°C for even a brief period or extended periods above 160°C can cause degradation of the GMR sensor element.
2. AKL- and DD-Series parts contain an on-chip EEPROM. Exposure to temperatures in excess of 265°C can cause EEPROM data corruption, which will cause the parts to fall out of specification.

Magnet Data

NVE supplies Ceramic 8 magnets in some of our GMR sensor evaluation kits. The characteristics for these magnets are given below:

Material Type	Ceramic 8 (C8)
Maximum Operating Temperature	300°C
Curie Temperature	450°C
Temperature Coefficient of Flux Density	-0.20 %/°C
Maximum Energy Product	3.5 MGOe
Residual Induction	3850 Gauss
Coercive Force	2950 Oersteds

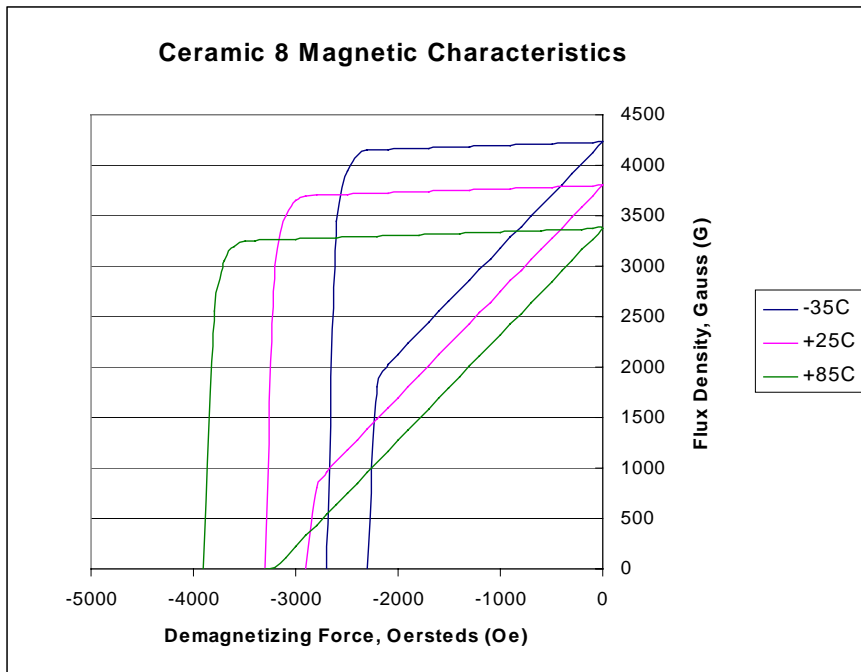

Magnet drawings for the two round disc magnets included in the GT Sensor evaluation kits are given below. These magnets are available from NVE as production parts. Contact NVE for pricing and delivery information. In addition, NVE can have custom magnets built for specific applications in Ceramic 8 or Alnico 8 materials. Please contact NVE for more details.

Ceramic 8 Disc Magnets

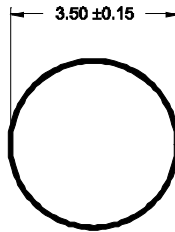
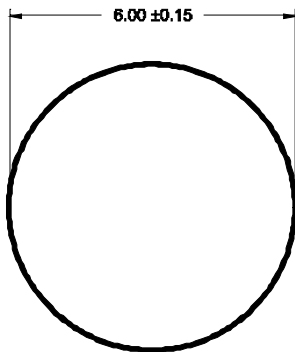

Note: All Dimensions in mm.

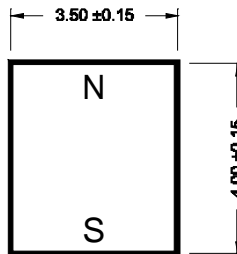
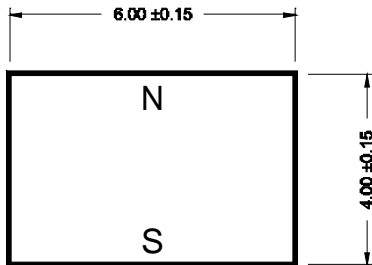

Magnet Part Number	Diameter (mm)	Length (mm)
12216	6	4
12217	3.5	4

Part Numbers and Marking Codes

NVE's part number format consists of two or three letters, then three numbers, a dash, and then two more numbers, and in some cases a final letter. Here is an example:

AAH004-00E

The meanings of the numbers and letters are defined as follows:

First Two Letters	General Part Description
AA	Analog output magnetometer or spin valve sensor
AB	Analog output gradiometer
AD	Digital output magnetometer
AG	Evaluation kit or printed circuit board assembly
AK	Digital output gradiometer
BD	Custom digital output magnetometer
DB	Digital input signal processing IC
DC	Voltage regulator
DD	Analog input signal processing IC

Third Letter	GMR Material Used In Product
	No third letter indicates NVE's standard multilayer material
H	High sensitivity, high temperature multilayer material
L	Low hysteresis, high temperature multilayer material
V	Spin valve material with synthetic anti-ferromagnet pinning

Three Digits	Consecutive Part Number
xxx	Meaning for AD-Series parts is described in the GMR Switch section of this catalog; other products have numbers assigned consecutively with no meaning implied

Two Digits After Dash	Package Type
-00	MSOP 8 pin package
-01	Raw IC (die); available in diced wafer on blue tape or waffle pack form
-02	SOIC 8 pin package
-07	Non-semiconductor style package; used for eval kits and PCBs
-10	TDFN6 2.5mm X 2.5mm 6 pin package
-11	PLL6 3.0mm X 3.0mm 6 pin package
-12	TDFN SO8 4.9mm X 6.0mm 8 pin package

Final Letter	Consecutive Part Number
E	No final letter means a standard package; E means a lead-free package

Some of NVE's products are delivered in packages that are too small to be marked with the complete part number. In these cases a three-letter code is used to identify the part. The following table provides a cross-reference from part number to marking code:

NVE Part Number	Code
AA004-00	CBD
AA006-00	CBC
AAH004-00	CBF
AAV001-11	BBP
AAV002-11	BBQ
AB001-00	CBG
ABH001-00	CBH
ABL004-00	FDB
ABL005-00	FDC
ABL006-00	FDL
ABL014-00	FDD
ABL015-00	FDG
ABL016-00	FDM
ABL004-10	FDG
ABL005-10	FDH
ABL006-10	FDN
ABL014-10	FDJ
ABL015-10	FDK
ABL016-10	FDP
AD004-00	BBH
AD005-00	BBG
AD006-00	BBJ
AD020-00	BBK
AD021-00	BBB
AD022-00	BBC
AD023-00	BBD
AD024-00	BBF
AD024-10	BBL
AD104-00	DBH
AD105-00	DBG
AD106-00	DBJ
AD120-00	DBK
AD121-00	DBB
AD122-00	DBC
AD123-00	DBD
AD124-00	DBF
AD204-00	FBH
AD205-00	FBG
AD206-00	FBJ
AD220-00	FBK
AD221-00	FBB
AD222-00	FBC
AD223-00	FBD
AD224-00	FBF
AD304-00	GBH
AD305-00	GBG
AD306-00	GBJ
AD320-00	GBK
AD321-00	GBB
AD322-00	GBC

NVE Part Number	Code
AD323-00	GBD
AD324-00	GBF
AD404-00	HBH
AD405-00	HBG
AD406-00	HBJ
AD420-00	HBK
AD421-00	HBB
AD422-00	HBC
AD423-00	HBD
AD424-00	HBF
AD504-00	JBH
AD505-00	JBG
AD506-00	BJJ
AD520-00	JBK
AD521-00	JBB
AD522-00	JBC
AD523-00	JBD
AD524-00	JBF
AD604-00	KBH
AD605-00	KBG
AD606-00	KBJ
AD620-00	KBK
AD621-00	KBB
AD622-00	KBC
AD623-00	KBD
AD624-00	KBF
AD704-00	LBH
AD705-00	LBG
AD706-00	LBJ
AD720-00	LBK
AD721-00	LBB
AD722-00	LBC
AD723-00	LBD
AD724-00	LBF
AD081-00	BDB
AD082-00	BDC
AD083-00	BDD
AD084-00	BDF
AD821-00	MBB
AD822-00	MBC
AD823-00	MBD
AD824-00	MBF
AD921-00	NBB
AD922-00	NBC
AD923-00	NBD
AD924-00	NBF
ADH025-00	MBL
BD012-00	ZBF
DB001-00	FFD
DC001-10	FFB
DC002-10	FFC

The following table provides a cross-reference from marking code to part number:

Code	NVE Part Number
BBB	AD021-00
BBC	AD022-00
BBD	AD023-00
BBF	AD024-00
BBG	AD005-00
BBH	AD004-00
BBJ	AD006-00
BBK	AD020-00
BBL	AD024-10
BBP	AAV001-11
BBQ	AAV002-11
BDB	AD081-00
BDC	AD082-00
BDD	AD083-00
BDF	AD084-00
CBC	AA006-00
CBD	AA004-00
CBF	AAH004-00
CBG	AB001-00
CBH	ABH001-00
DBB	AD121-00
DBC	AD122-00
DBD	AD123-00
DBF	AD124-00
DBG	AD105-00
DBH	AD104-00
DBJ	AD106-00
DBK	AD120-00
FBB	AD221-00
FBC	AD222-00
FBD	AD223-00
FBF	AD224-00
FBG	AD205-00
FBH	AD204-00
FBJ	AD206-00
FBK	AD220-00
FDB	ABL004-00
FDC	ABL005-00
FDD	ABL014-00
FDG	ABL015-00
FDH	ABL004-10
FDI	ABL005-10
FDJ	ABL014-10
FDK	ABL015-10
FDL	ABL006-00
FDM	ABL016-00
FDN	ABL006-10
FDP	ABL016-10
FFB	DC001-10
FFC	DC002-10

Code	NVE Part Number
FFD	DB001-00
GBB	AD321-00
GBC	AD322-00
GBD	AD323-00
GBF	AD324-00
GBG	AD305-00
GBH	AD304-00
GBJ	AD306-00
GBK	AD320-00
HBB	AD421-00
HBC	AD422-00
HBD	AD423-00
HBF	AD424-00
HBG	AD405-00
HBH	AD404-00
HBJ	AD406-00
HBK	AD420-00
JBB	AD521-00
JBC	AD522-00
JBD	AD523-00
JBF	AD524-00
JBG	AD505-00
JBH	AD504-00
JBK	AD506-00
JBJ	AD520-00
KBB	AD621-00
KBC	AD622-00
KBD	AD623-00
KBF	AD624-00
KBG	AD605-00
KBH	AD604-00
KBJ	AD606-00
KBK	AD620-00
LBB	AD721-00
LBC	AD722-00
LBD	AD723-00
LBF	AD724-00
LBG	AD705-00
LBH	AD704-00
LBJ	AD706-00
LBK	AD720-00
MBB	AD821-00
MBC	AD822-00
MBD	AD823-00
MBF	AD824-00
MBL	ADH025-00
NBB	AD921-00
NBC	AD922-00
NBD	AD923-00
NBF	AD924-00
ZBF	BD012-00

Definitions and Conversion Factors

Definitions:

CSK or Sink: Current sinking output, also referred to as Open Collector output.

Differential: The field difference between the Operate Point and the Release Point.

Electrical Offset: The inherent imbalance of the bridge expressed in differential voltage output.

HBM: Human Body Model for ESD specifications.

Hysteresis: The maximum deviation in volts between the output with increasing field and the output with decreasing field, where the applied field is unipolar (applied in either a positive or negative direction, without crossing the zero field point), divided by Voltage Span. Expressed as a percentage.

Input Voltage Range: The voltage range that can be applied across the bridge.

IOL (Current Output Low): The output current in the low (logic 0) state (output stage switched on).

Max Output: A specification given in millivolts per applied voltage. This is the maximum output voltage possible. This output condition is achieved when one set of resistors is in magnetic saturation (have achieved the maximum resistance change possible) while the other pair are at zero applied magnetic field.

Nonlinearity: The maximum deviation from a linear fit taken over the Field Range divided by the Voltage Span. Expressed as a percentage.

Off-axis Characteristic: A specification that describes the variation in sensor output versus the angle between the applied field direction and the sensitive axis of the GMR sensor with constant electrical and magnetic inputs applied. Applicable to non-integrated bridge sensors. The output will vary as the cosine of the angle rotated.

Operate Point: The field level which produces a logical change in state from “0” to “1” in NVE’s digital magnetic field sensors ADXXX-XX.

Operating Frequency: Frequency range within which a sensor will produce a responsive output.

Output Leakage Current (Current Output High): The output current in the high (logic 1) state (output stage switched off).

Output Saturation Voltage (Voltage Output Low): The output voltage in the low (logic 0) state (output stage switched on).

RBP: Reverse Battery Protection.

Release Point: The field level which produces a logical change in state from “1” to “0” in NVE’s digital magnetic field sensors ADXXX-XX.

Resistor Separation: This is the mean separation between the two pairs of resistors, in a Gradiometer or Differential sensor.

Sensitivity: A measure of the output magnitude based on electrical and magnetic input conditions. Expressed in millivolts of differential output per applied voltage per Oersted.

Specified Linear Range: Typically 70% of the field it takes to saturate the part. Field dependent specifications are based upon this range.

TCOI (Temperature Coefficient of Output at Constant Input Current): The variation of the output voltage over temperature with a constant input current applied. Expressed as a percentage per unit temperature change.

TCOV (Temperature Coefficient of Output at Constant Input Voltage): The variation of the output voltage over temperature with a constant input voltage applied. Expressed as a percentage per unit temperature change.

TCR (Temperature Coefficient of Resistance): The variation of the GMR resistors over temperature. Expressed as a percentage per unit temperature change.

Voltage Span: The differential output voltage taken from zero to 70% of the saturation field level.

Conversion Factors

To Convert	Into	Multiply by
μWb	maxwell	10^2
A/cm	Oe	1.256
A/m	Oe	1.256×10^{-2}
At	Gb	1.256
G	Oe	1 (when $\mu_o=1$)
G	T	10^{-4}
G	mT	10^{-1}
G	nT	10^5
G	Wb/cm ²	10^{-8}
G	Wb/in ²	6.452×10^{-8}
G	Wb/m ²	10^{-4}
Gb	At	0.796
kA/m	Oe	1.256×10^1
maxwell	Wb	10^{-8}
maxwell	μWb	10^{-2}
mT	G	10
maxwell	volt second	10^{-8}
nT	G	10^{-5}
nT	gamma (γ)	1
Oe	A/cm	7.962×10^{-1}
Oe	A/m	7.962×10^1
Oe	kA/m	7.962×10^{-2}
T	G	10^4
T	Wb/m ²	1
volt second	maxwell	10^8
volt second	Wb	1
Wb	maxwell	10^8
Wb/cm ²	G	10^8
Wb/m ²	G	10^4