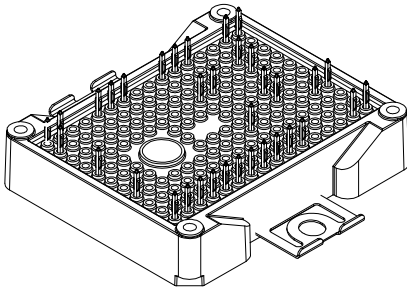
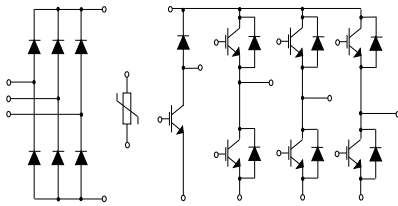


## ACEPACK™ 2 converter inverter brake, 1200 V, 25 A, trench gate field-stop M series IGBT with soft diode and NTC


**ACEPACK™ 2**


### Features

- ACEPACK™ 2 power module
  - DBC Cu Al<sub>2</sub>O<sub>3</sub> Cu
- Converter inverter brake topology
  - 1600 V, very low drop rectifiers for converter
  - 1200 V, 25 A IGBTs and diodes
  - Soft and fast recovery diode
- Integrated NTC

### Applications

- Inverters
- Motor drives

### Description

This power module is a converter-inverter brake (CIB) topology in an ACEPACK™ 2 package with NTC, integrating the advanced trench gate field-stop technology from STMicroelectronics. This new IGBT technology represents the best compromise between conduction and switching loss, to maximize the efficiency of any converter system up to 20 kHz.



#### Product status

A2C25S12M3-F

#### Product summary

<b>Order code</b>	A2C25S12M3-F
<b>Marking</b>	A2C25S12M3-F
<b>Package</b>	ACEPACK™ 2
<b>Leads type</b>	Press fit contact pins

# 1 Electrical ratings

## 1.1 Inverter stage

Limiting values at  $T_J = 25\text{ °C}$ , unless otherwise specified.

### 1.1.1 IGBTs

**Table 1. Absolute maximum ratings of the IGBTs, inverter stage**

Symbol	Description	Value	Unit
$V_{CES}$	Collector-emitter voltage ( $V_{GE} = 0\text{ V}$ )	1200	V
$I_C$	Continuous collector current ( $T_C = 100\text{ °C}$ )	25	A
$I_{CP}^{(1)}$	Pulsed collector current ( $t_p = 1\text{ ms}$ )	50	A
$V_{GE}$	Gate-emitter voltage	$\pm 20$	V
$P_{TOT}$	Total power dissipation of each IGBT ( $T_C = 25\text{ °C}$ , $T_J = 175\text{ °C}$ )	197	W
$T_{JMAX}$	Maximum junction temperature	175	°C
$T_{Jop}$	Operating junction temperature range under switching conditions	-40 to 150	°C

1. Pulse width limited by maximum junction temperature.

**Table 2. Electrical characteristics of the IGBTs, inverter stage**

Symbol	Parameter	Test conditions	Min.	Typ.	Max.	Unit
$V_{(BR)CES}$	Collector-emitter breakdown voltage	$I_C = 1\text{ mA}$ , $V_{GE} = 0\text{ V}$	1200			V
$V_{CE(sat)}$ (terminal)	Collector-emitter saturation voltage	$V_{GE} = 15\text{ V}$ , $I_C = 25\text{ A}$		1.95	2.45	V
		$V_{GE} = 15\text{ V}$ , $I_C = 25\text{ A}$ , $T_J = 150\text{ °C}$		2.3		V
$V_{GE(th)}$	Gate threshold voltage	$V_{CE} = V_{GE}$ , $I_C = 1\text{ mA}$	5	6	7	V
$I_{CES}$	Collector cut-off current	$V_{GE} = 0\text{ V}$ , $V_{CE} = 1200\text{ V}$			100	$\mu\text{A}$
$I_{GES}$	Gate-emitter leakage current	$V_{CE} = 0\text{ V}$ , $V_{GE} = \pm 20\text{ V}$			$\pm 500$	nA
$C_{ies}$	Input capacitance	$V_{CE} = 25\text{ V}$ , $f = 1\text{ MHz}$ , $V_{GE} = 0\text{ V}$		1550		pF
$C_{oes}$	Output capacitance			130		pF
$C_{res}$	Reverse transfer capacitance			65		pF
$Q_g$	Total gate charge	$V_{CC} = 960\text{ V}$ , $I_C = 25\text{ A}$ , $V_{GE} = \pm 15\text{ V}$		80		nC
$t_{d(on)}$	Turn-on delay time	$V_{CC} = 600\text{ V}$ , $I_C = 25\text{ A}$ , $R_G = 15\text{ }\Omega$ , $V_{GE} = \pm 15\text{ V}$ , $di/dt = 1290\text{ A}/\mu\text{s}$		109		ns
$t_r$	Current rise time			15.3		ns
$E_{on}^{(1)}$	Turn-on switching energy			0.97		mJ

Symbol	Parameter	Test conditions	Min.	Typ.	Max.	Unit
$t_{d(off)}$	Turn-off delay time	$V_{CC} = 600\text{ V}$ , $I_C = 25\text{ A}$ ,		109		ns
$t_f$	Current fall time	$R_G = 15\ \Omega$ , $V_{GE} = \pm 15\text{ V}$ ,		132		ns
$E_{off}^{(2)}$	Turn-off switching energy	$dv/dt = 9600\text{ V}/\mu\text{s}$		1.36		mJ
$t_{d(on)}$	Turn-on delay time	$V_{CC} = 600\text{ V}$ , $I_C = 25\text{ A}$ ,		109		ns
$t_r$	Current rise time	$R_G = 15\ \Omega$ , $V_{GE} = \pm 15\text{ V}$ ,		16.2		ns
$E_{on}^{(1)}$	Turn-on switching energy	$di/dt = 1274\text{ A}/\mu\text{s}$ , $T_J = 150\text{ }^\circ\text{C}$		1.49		mJ
$t_{d(off)}$	Turn-off delay time	$V_{CC} = 600\text{ V}$ , $I_C = 25\text{ A}$ ,		122		ns
$t_f$	Current fall time	$R_G = 15\ \Omega$ , $V_{GE} = \pm 15\text{ V}$ ,		216		ns
$E_{off}^{(2)}$	Turn-off switching energy	$dv/dt = 8200\text{ V}/\mu\text{s}$ , $T_J = 150\text{ }^\circ\text{C}$		1.85		mJ
$t_{SC}$	Short-circuit withstand time	$V_{CC} \leq 600\text{ V}$ , $V_{GE} \leq 15\text{ V}$ , $T_{Jstart} \leq 150\text{ }^\circ\text{C}$	10			$\mu\text{s}$
$R_{THj-c}$	Thermal resistance junction-to-case	Each IGBT		0.69	0.76	$^\circ\text{C}/\text{W}$
$R_{THc-h}$	Thermal resistance case-to-heatsink	Each IGBT, $\lambda_{grease} = 1\text{ W}/(\text{m}\cdot^\circ\text{C})$		0.79		$^\circ\text{C}/\text{W}$

1. Including the reverse recovery of the diode.
2. Including the tail of the collector current.

### 1.1.2

#### Diode

Limiting values at  $T_J = 25\text{ }^\circ\text{C}$ , unless otherwise specified.

**Table 3. Absolute maximum ratings of the diode, inverter stage**

Symbol	Parameter	Value	Unit
$V_{RRM}$	Repetitive peak reverse voltage	1200	V
$I_F$	Continuous forward current ( $T_C = 100\text{ }^\circ\text{C}$ )	25	A
$I_{FP}^{(1)}$	Pulsed forward current ( $t_p = 1\text{ ms}$ )	50	A
$T_{JMAX}$	Maximum junction temperature	175	$^\circ\text{C}$
$T_{Jop}$	Operating junction temperature range under switching conditions	-40 to 150	$^\circ\text{C}$

1. Pulse width limited by maximum junction temperature.

**Table 4. Electrical characteristics of the diode, inverter stage**

Symbol	Parameter	Test conditions	Min.	Typ.	Max.	Unit
$V_F$ (terminal)	Forward voltage	$I_F = 25\text{ A}$	-	2.95	4.1	V
		$I_F = 25\text{ A}$ , $T_J = 150\text{ }^\circ\text{C}$	-	2.3		
$t_{rr}$	Reverse recovery time		-	190		ns
$Q_{rr}$	Reverse recovery charge	$I_F = 25\text{ A}$ , $V_R = 600\text{ V}$ ,	-	1.53		$\mu\text{C}$
$I_{rrm}$	Reverse recovery current	$V_{GE} = \pm 15\text{ V}$ , $di_F/dt = 1290\text{ A}/\mu\text{s}$	-	29		A
$E_{rec}$	Reverse recovery energy		-	0.74		mJ

Symbol	Parameter	Test conditions	Min.	Typ.	Max.	Unit
$t_{rr}$	Reverse recovery time	$I_F = 25\text{ A}$ , $V_R = 600\text{ V}$ , $V_{GE} = \pm 15\text{ V}$ , $di_F/dt = 1274\text{ A}/\mu\text{s}$ , $T_J = 150\text{ }^\circ\text{C}$	-	378		ns
$Q_{rr}$	Reverse recovery charge		-	4.43		$\mu\text{C}$
$I_{rrm}$	Reverse recovery current		-	41		A
$E_{rec}$	Reverse recovery energy		-	2.33		mJ
$R_{THj-c}$	Thermal resistance junction-to-case	Each diode	-	1.05	1.16	$^\circ\text{C}/\text{W}$
$R_{THc-h}$	Thermal resistance case-to-heatsink	Each diode, $\lambda_{grease} = 1\text{ W}/(\text{m}\cdot^\circ\text{C})$	-	0.85		$^\circ\text{C}/\text{W}$

## 1.2 Brake stage

Limiting values at  $T_J = 25\text{ }^\circ\text{C}$ , unless otherwise specified.

### 1.2.1 IGBT

**Table 5. Absolute maximum ratings of the IGBT, brake stage**

Symbol	Parameter	Value	Unit
$V_{CES}$	Collector-emitter voltage ( $V_{GE} = 0\text{ V}$ )	1200	V
$I_C$	Continuous collector current ( $T_C = 100\text{ }^\circ\text{C}$ )	25	A
$I_{CP}^{(1)}$	Pulsed collector current ( $t_p = 1\text{ ms}$ )	50	A
$V_{GE}$	Gate-emitter voltage	$\pm 20$	V
$P_{TOT}$	Total power dissipation of each IGBT ( $T_C = 25\text{ }^\circ\text{C}$ , $T_J = 175\text{ }^\circ\text{C}$ )	197	W
$T_{JMAX}$	Maximum junction temperature	175	$^\circ\text{C}$
$T_{Jop}$	Operating junction temperature range under switching conditions	-40 to 150	$^\circ\text{C}$

1. Pulse width limited by maximum junction temperature.

**Table 6. Electrical characteristics of the IGBT, brake stage**

Symbol	Parameter	Test conditions	Min.	Typ.	Max.	Unit
$V_{(BR)CES}$	Collector-emitter breakdown voltage	$I_C = 1\text{ mA}$ , $V_{GE} = 0\text{ V}$	1200			V
$V_{CE(sat)}$ (terminal)	Collector-emitter saturation voltage	$V_{GE} = 15\text{ V}$ , $I_C = 25\text{ A}$		1.95		V
		$V_{GE} = 15\text{ V}$ , $I_C = 25\text{ A}$ , $T_J = 150\text{ }^\circ\text{C}$		2.3		
$V_{GE(th)}$	Gate threshold voltage	$V_{CE} = V_{GE}$ , $I_C = 1\text{ mA}$	5	6	7	V
$I_{CES}$	Collector cut-off current	$V_{GE} = 0\text{ V}$ , $V_{CE} = 1200\text{ V}$			100	$\mu\text{A}$
$I_{GES}$	Gate-emitter leakage current	$V_{CE} = 0\text{ V}$ , $V_{GE} = \pm 20\text{ V}$			$\pm 500$	nA
$C_{ies}$	Input capacitance	$V_{CE} = 25\text{ V}$ , $f = 1\text{ MHz}$ , $V_{GE} = 0\text{ V}$		1550		pF
$C_{oes}$	Output capacitance				130	pF
$C_{res}$	Reverse transfer capacitance				65	pF
$Q_g$	Total gate charge	$V_{CC} = 960\text{ V}$ , $I_C = 25\text{ A}$ , $V_{GE} = \pm 15\text{ V}$		80		nC

Symbol	Parameter	Test conditions	Min.	Typ.	Max.	Unit
$t_{d(on)}$	Turn-on delay time	$V_{CC} = 600\text{ V}$ , $I_C = 25\text{ A}$ , $R_G = 15\ \Omega$ , $V_{GE} = \pm 15\text{ V}$ , $di/dt = 1290\text{ A}/\mu\text{s}$		109		ns
$t_r$	Current rise time			15.3		ns
$E_{on}^{(1)}$	Turn-on switching energy			0.97		mJ
$t_{d(off)}$	Turn-off delay time	$V_{CC} = 600\text{ V}$ , $I_C = 25\text{ A}$ , $R_G = 15\ \Omega$ , $V_{GE} = \pm 15\text{ V}$ , $dv/dt = 9600\text{ V}/\mu\text{s}$		109		ns
$t_f$	Current fall time			132		ns
$E_{off}^{(2)}$	Turn-off switching energy			1.36		mJ
$t_{d(on)}$	Turn-on delay time	$V_{CC} = 600\text{ V}$ , $I_C = 25\text{ A}$ , $R_G = 15\ \Omega$ , $V_{GE} = \pm 15\text{ V}$ , $di/dt = 1274\text{ A}/\mu\text{s}$ , $T_J = 150\text{ }^\circ\text{C}$		109		ns
$t_r$	Current rise time			16.2		ns
$E_{on}^{(1)}$	Turn-on switching energy			1.49		mJ
$t_{d(off)}$	Turn-off delay time	$V_{CC} = 600\text{ V}$ , $I_C = 25\text{ A}$ , $R_G = 15\ \Omega$ , $V_{GE} = \pm 15\text{ V}$ , $dv/dt = 8200\text{ V}/\mu\text{s}$ , $T_J = 150\text{ }^\circ\text{C}$		122		ns
$t_f$	Current fall time			216		ns
$E_{off}^{(2)}$	Turn-off switching energy			1.85		mJ
$t_{SC}$	Short-circuit withstand time	$V_{CC} \leq 600\text{ V}$ , $V_{GE} \leq 15\text{ V}$ , $T_{Jstart} \leq 150\text{ }^\circ\text{C}$	10			$\mu\text{s}$
$R_{THj-c}$	Thermal resistance junction-to-case	Each IGBT		0.69	0.76	$^\circ\text{C}/\text{W}$
$R_{THc-h}$	Thermal resistance case-to-heatsink	Each IGBT, $\lambda_{grease} = 1\text{ W}/(\text{m}\cdot^\circ\text{C})$		0.79		$^\circ\text{C}/\text{W}$

1. Including the reverse recovery of the diode.
2. Including the tail of the collector current.

## 1.2.2 Diode

**Table 7. Absolute maximum ratings of the diode, brake stage**

Symbol	Parameter	Value	Unit
$V_{RRM}$	Repetitive peak reverse voltage	1200	V
$I_F$	Continuous forward current ( $T_C = 100\text{ }^\circ\text{C}$ )	25	A
$I_{FP}^{(1)}$	Pulsed forward current ( $t_p = 1\text{ ms}$ )	50	A
$T_{JMAX}$	Maximum junction temperature	175	$^\circ\text{C}$
$T_{Jop}$	Operating junction temperature range under switching conditions	-40 to 150	$^\circ\text{C}$

1. Pulse width limited by maximum junction temperature.

**Table 8. Electrical characteristics of the diode, brake stage**

Symbol	Parameter	Test conditions	Min.	Typ.	Max.	Unit
$V_F$ (terminal)	Forward voltage	$I_F = 25\text{ A}$	-	2.95		V
		$I_F = 25\text{ A}$ , $T_J = 150\text{ }^\circ\text{C}$	-	2.3		
$t_{rr}$	Reverse recovery time	$I_F = 25\text{ A}$ , $V_R = 600\text{ V}$ , $V_{GE} = \pm 15\text{ V}$ , $di/dt = 1290\text{ A}/\mu\text{s}$	-	190		ns
$Q_{rr}$	Reverse recovery charge		-	1.53		$\mu\text{C}$
$I_{rrm}$	Reverse recovery current		-	29		A
$E_{rec}$	Reverse recovery energy		-	0.74		mJ

Symbol	Parameter	Test conditions	Min.	Typ.	Max.	Unit
$t_{rr}$	Reverse recovery time	$I_F = 25\text{ A}$ , $V_R = 600\text{ V}$ , $V_{GE} = \pm 15\text{ V}$ , $di/dt = 1274\text{ A}/\mu\text{s}$ , $T_J = 150\text{ }^\circ\text{C}$	-	378		ns
$Q_{rr}$	Reverse recovery charge		-	4.43		$\mu\text{C}$
$I_{rrm}$	Reverse recovery current		-	41		A
$E_{rec}$	Reverse recovery energy		-	2.33		mJ
$R_{THj-c}$	Thermal resistance junction-to-case	Each diode	-	1.05	1.16	$^\circ\text{C}/\text{W}$
$R_{THc-h}$	Thermal resistance case-to-heatsink	Each diode, $\lambda_{grease} = 1\text{ W}/(\text{m}\cdot^\circ\text{C})$	-	0.85		$^\circ\text{C}/\text{W}$

### 1.3

## Converter stage

Limiting values at  $T_J = 25\text{ }^\circ\text{C}$ , unless otherwise specified.

**Table 9. Absolute maximum ratings of the bridge rectifiers**

Symbol	Description	Value	Unit
$V_{RRM}$	Repetitive peak reverse voltage	1600	V
$I_F$	RMS forward current	50	A
$I_{FSM}$	Forward surge current $t_p = 10\text{ ms}$ , $T_C = 25\text{ }^\circ\text{C}$	450	A
	Forward surge current $t_p = 10\text{ ms}$ , $T_C = 150\text{ }^\circ\text{C}$	365	
$I^2t$	$t_p = 10\text{ ms}$ , $T_C = 25\text{ }^\circ\text{C}$	1012	$\text{A}^2\text{s}$
	$t_p = 10\text{ ms}$ , $T_C = 150\text{ }^\circ\text{C}$	666	
$T_{JMAX}$	Maximum junction temperature	175	$^\circ\text{C}$
$T_{Jop}$	Operating junction temperature range under switching conditions	-40 to 150	$^\circ\text{C}$

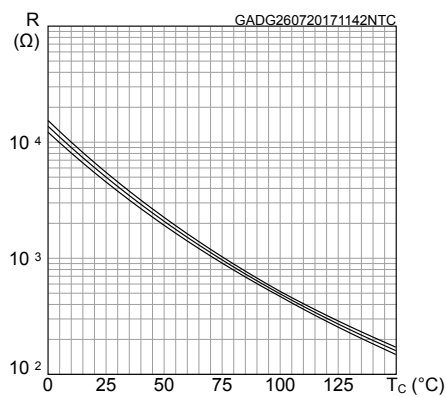
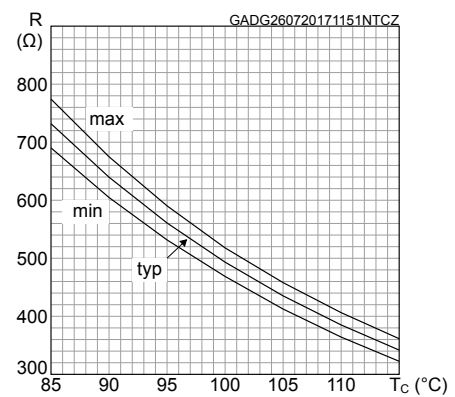
**Table 10. Electrical characteristics of the bridge rectifiers**

Symbol	Parameter	Test conditions	Min.	Typ.	Max.	Unit
$V_F$ (terminal)	Forward voltage	$I_F = 25\text{ A}$	-	1.05	1.4	V
		$I_F = 25\text{ A}$ , $T_J = 150\text{ }^\circ\text{C}$	-	0.92		
$I_R$	Reverse current	$T_J = 150\text{ }^\circ\text{C}$ , $V_R = 1600\text{ V}$	-	1		mA
$R_{THj-c}$	Thermal resistance junction-to-case	Each diode	-	1.00	1.10	$^\circ\text{C}/\text{W}$
$R_{THc-h}$	Thermal resistance case-to-heatsink	Each diode, $\lambda_{grease} = 1\text{ W}/(\text{m}\cdot^\circ\text{C})$	-	0.95		$^\circ\text{C}/\text{W}$

## 1.4 NTC

**Table 11. NTC temperature sensor, considered as stand-alone**

Symbol	Parameter	Test condition	Min.	Typ.	Max.	Unit
R <sub>25</sub>	Resistance	T = 25 °C		5		kΩ
R <sub>100</sub>	Resistance	T = 100 °C		493		Ω
ΔR/R	Deviation of R <sub>100</sub>		-5		+5	%
B <sub>25/50</sub>	B-constant			3375		K
B <sub>25/80</sub>	B-constant			3411		K
T	Operating temperature range		-40		150	°C

**Figure 1. NTC resistance vs temperature**

**Figure 2. NTC resistance vs temperature, zoom**


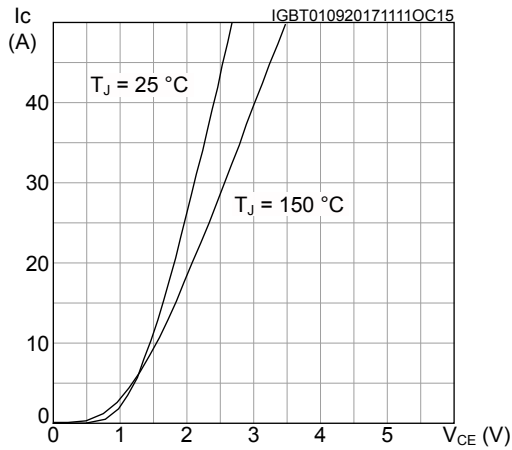
## 1.5 Package

**Table 12. ACEPACK™ 2 package**

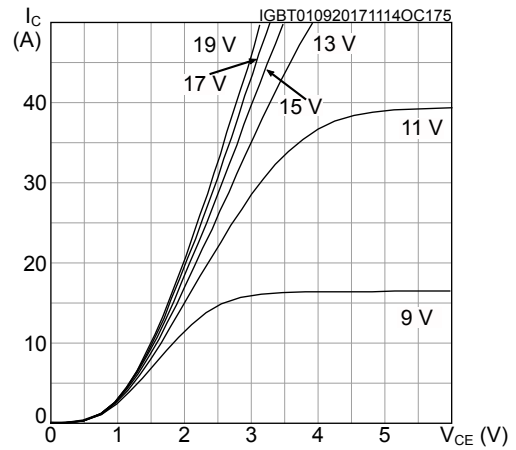
Symbol	Parameter	Min.	Typ.	Max.	Unit
V <sub>isol</sub>	Isolation voltage (AC voltage, t = 60 s)			2500	Vrms
T <sub>stg</sub>	Storage temperature	-40		125	°C
CTI	Comparative tracking index	200			
L <sub>s</sub>	Stray inductance module P1 - EW loop		33.5		nH
R <sub>s</sub>	Module single lead resistance, terminal to chip		3.6		mΩ

## 2 Electrical characteristics (curves)

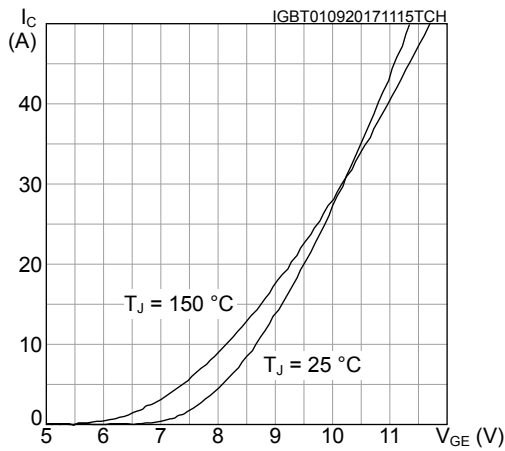
**Figure 3. IGBT output characteristics**  
( $V_{GE} = 15\text{ V}$ , terminal)



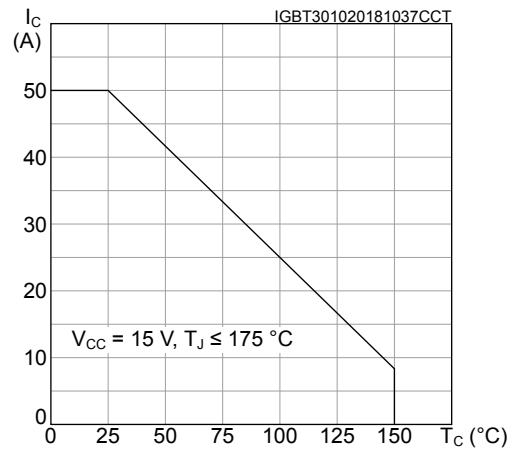
**Figure 4. IGBT output characteristics** ( $T_J = 150\text{ °C}$ , terminal)



**Figure 5. IGBT transfer characteristics**  
( $V_{CE} = 15\text{ V}$ , terminal)

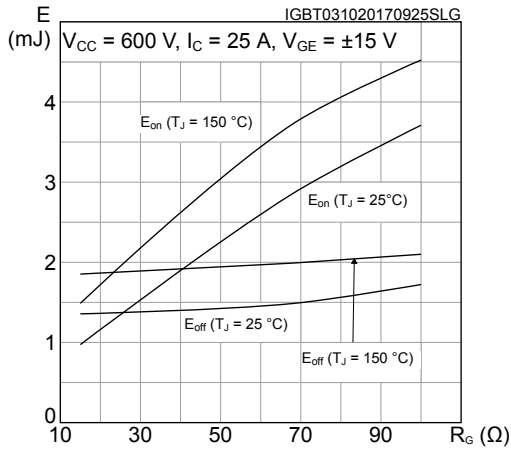


**Figure 6. IGBT collector current vs case temperature**

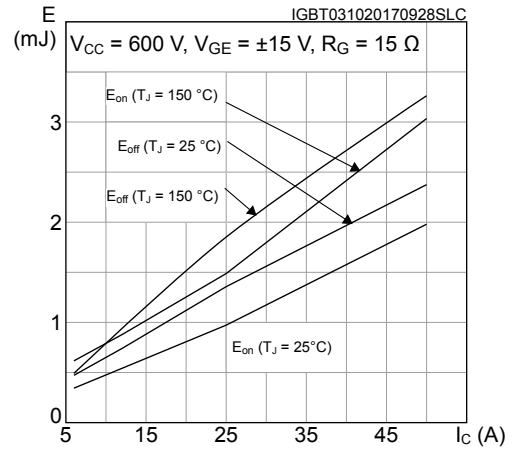




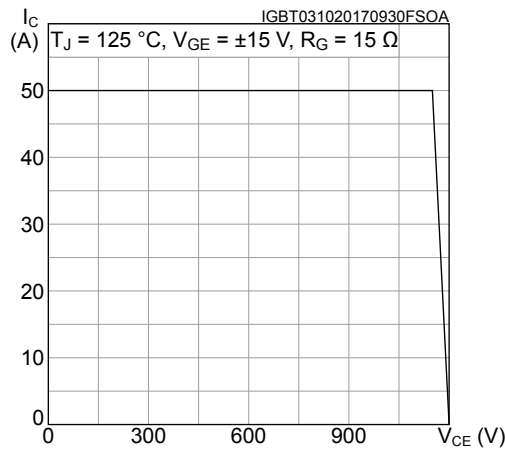
**Figure 7. Switching energy vs gate resistance**



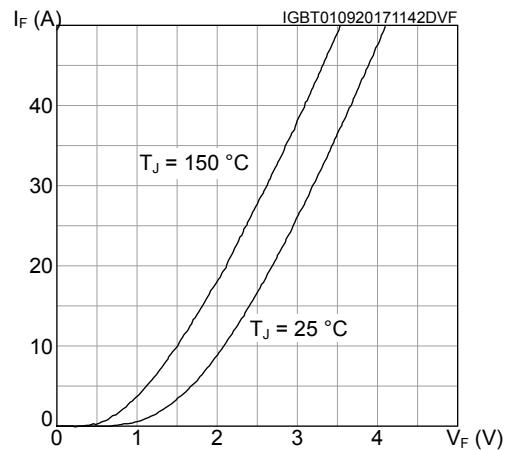
**Figure 8. Switching energy vs collector current**



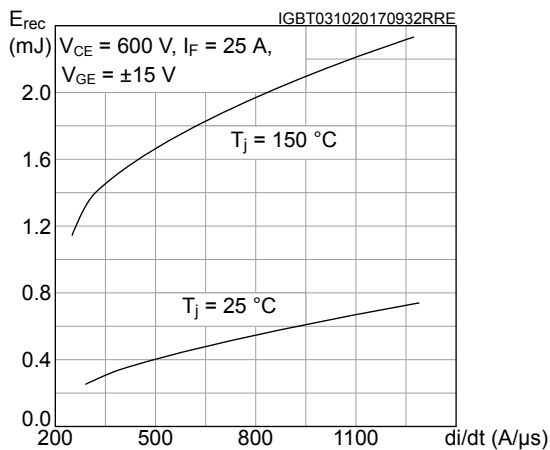
**Figure 9. IGBT reverse biased safe operating area (RBSOA)**



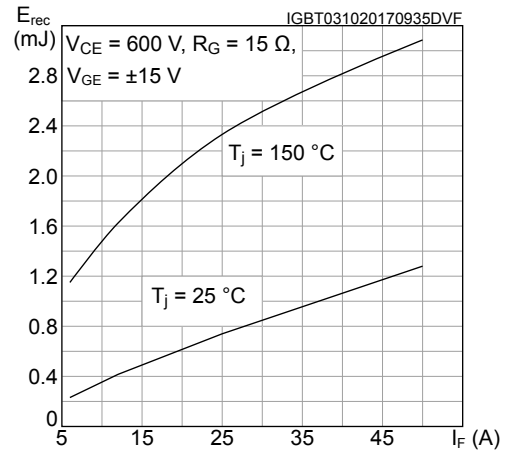
**Figure 10. Diode forward characteristics (terminal)**



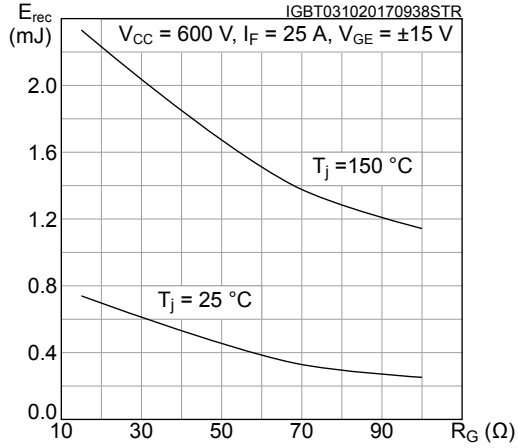
**Figure 11. Diode reverse recovery energy vs diode current slope**



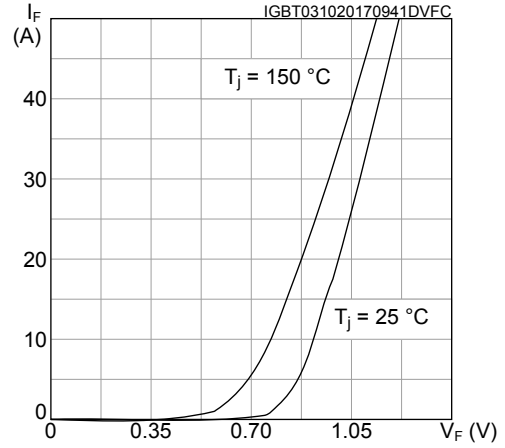
**Figure 12. Diode reverse recovery energy vs forward current**



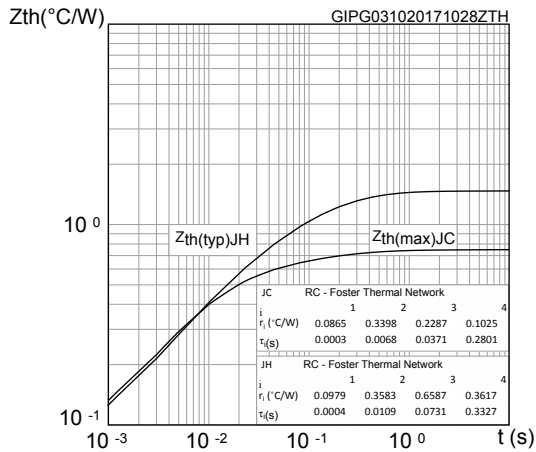
**Figure 13. Diode reverse recovery energy vs gate resistance**



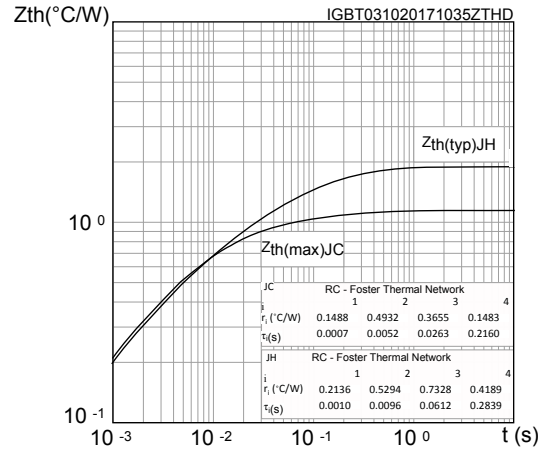
**Figure 14. Converter diode forward characteristics (terminal)**



**Figure 15. IGBT thermal impedance**



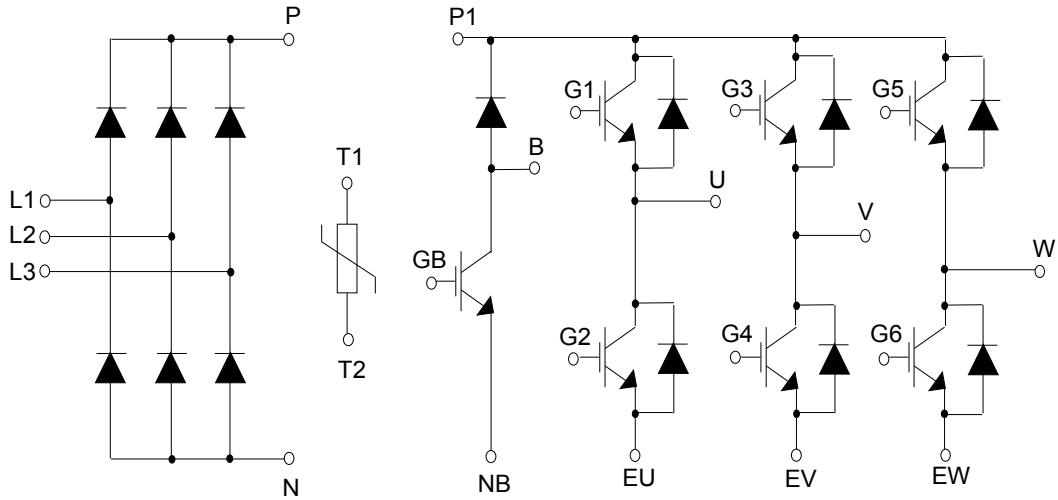
**Figure 16. Inverter diode thermal impedance**



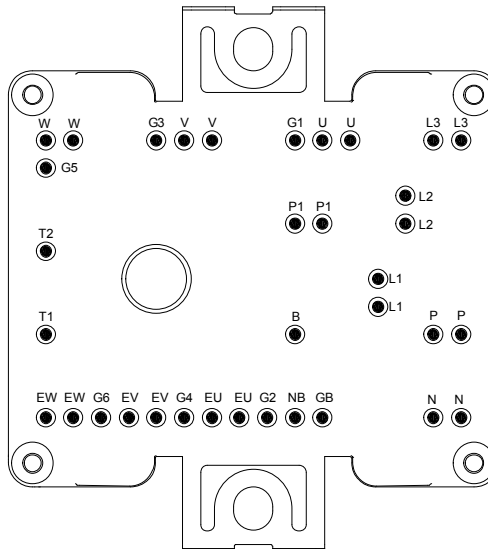


## 4 Topology and pin description

**Figure 21. Electrical topology and pin description**



**Figure 22. Package top view with CIB pinout**



GADG041020170942SA

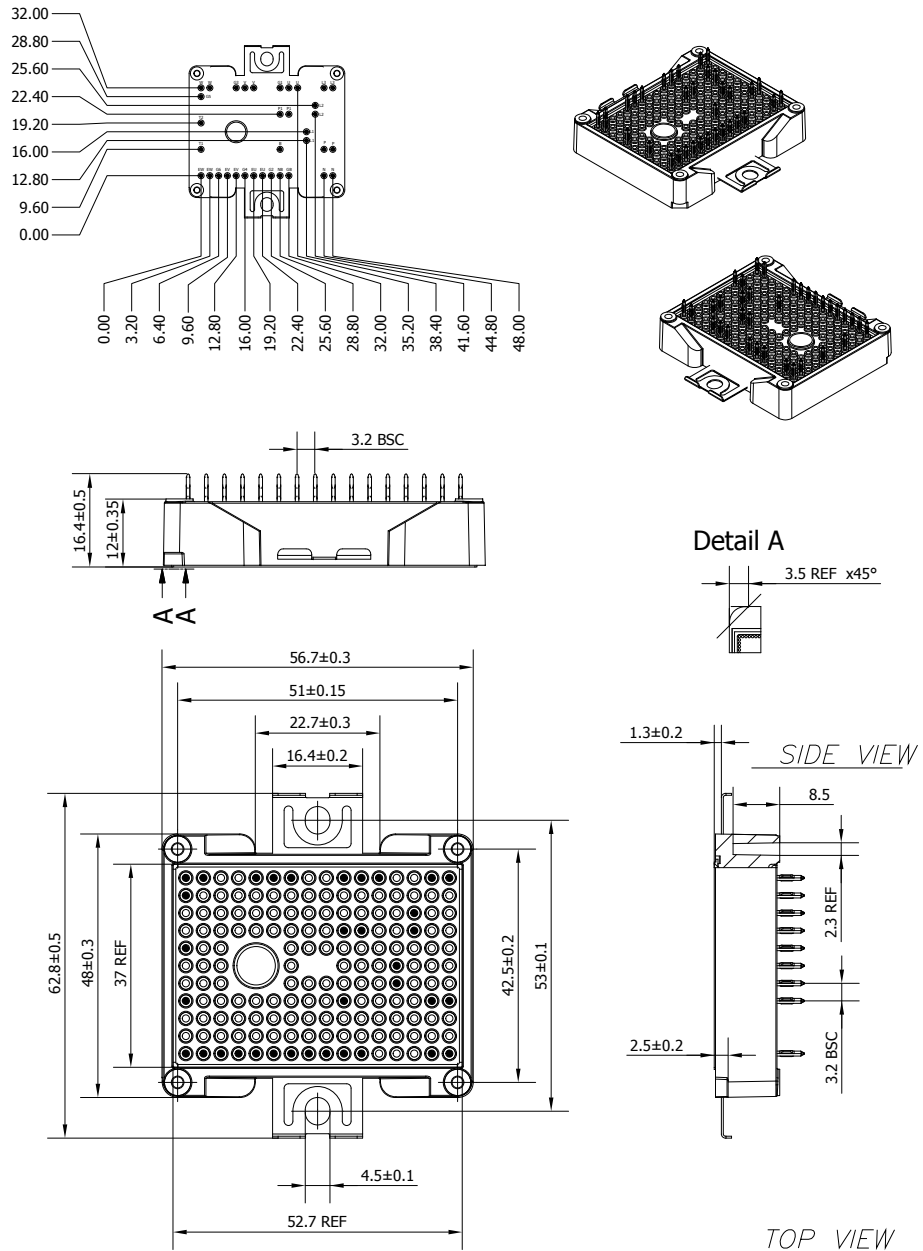
## 5 Package information

---

In order to meet environmental requirements, ST offers these devices in different grades of **ECOPACK<sup>®</sup>** packages, depending on their level of environmental compliance. ECOPACK<sup>®</sup> specifications, grade definitions and product status are available at: [www.st.com](http://www.st.com). ECOPACK<sup>®</sup> is an ST trademark.

## 5.1 ACEPACK™ 2 CIB press fit contact pins package information

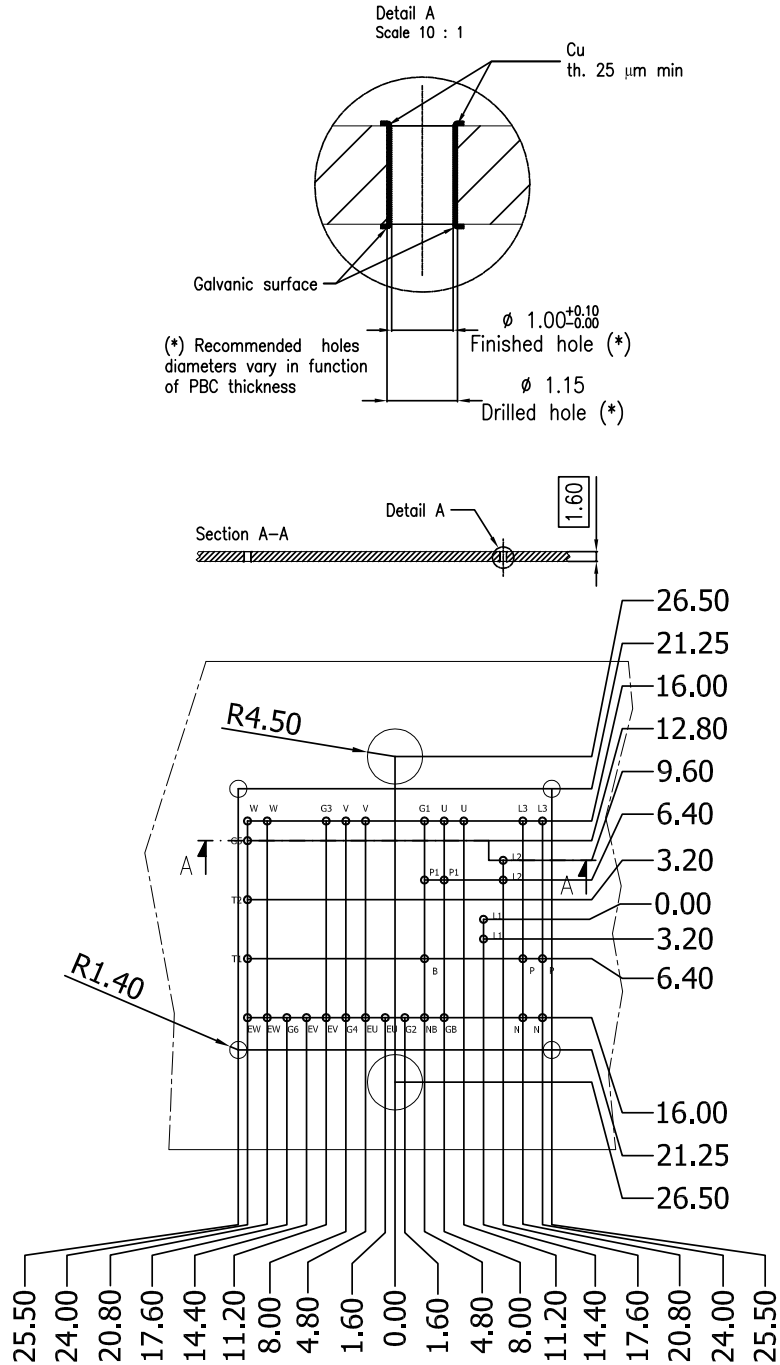
**Figure 23. ACEPACK™ 2 CIB press fit contact pins package outline (dimensions are in mm)**



8569722\_ACEPACK2\_CIB\_Press\_fit\_contact\_pins\_rev4

- The lead size includes the thickness of the lead plating material.
- Dimensions do not include mold protrusion.
- Package dimensions do not include any eventual metal burrs.

**Figure 24. ACEPACK™ 2 CIB press fit contact pins recommended PCB holes layout (dimensions are in mm)**



8569722\_ACEPACK2\_CIB\_Press\_fit\_contact\_pins\_PCBholes\_rev4

## Revision history

**Table 13. Document revision history**

Date	Revision	Changes
02-Oct-2017	1	Initial release.
13-Mar-2018	2	<p>Removed maturity status indication from cover page. The document status is production data.</p> <p>Modified features on cover page.</p> <p>Updated <i>Figure 7. Switching energy vs collector current</i>, <i>Figure 14. IGBT thermal impedance</i> and <i>Figure 15. Inverter diode thermal impedance</i>.</p> <p>Updated <i>Section 5.1 ACEPACK™ 2 CIB press fit contact pins package information</i>.</p> <p>Minor text changes.</p>
14-Nov-2018	3	<p>Added <a href="#">Figure 6. IGBT collector current vs case temperature</a>.</p> <p>Minor text changes</p>



## Contents

<b>1</b>	<b>Electrical ratings</b>	<b>2</b>
1.1	Inverter stage	2
1.1.1	IGBTs	2
1.1.2	Diode	3
1.2	Brake stage	4
1.2.1	IGBT	4
1.2.2	Diode	5
1.3	Converter stage	6
1.4	NTC	7
1.5	Package	7
<b>2</b>	<b>Electrical characteristics (curves)</b>	<b>8</b>
<b>3</b>	<b>Test circuits</b>	<b>11</b>
<b>4</b>	<b>Topology and pin description</b>	<b>12</b>
<b>5</b>	<b>Package information</b>	<b>13</b>
5.1	ACEPACK™ 2 CIB press fit contact pins package information	14
	<b>Revision history</b>	<b>16</b>

**IMPORTANT NOTICE – PLEASE READ CAREFULLY**

STMicroelectronics NV and its subsidiaries (“ST”) reserve the right to make changes, corrections, enhancements, modifications, and improvements to ST products and/or to this document at any time without notice. Purchasers should obtain the latest relevant information on ST products before placing orders. ST products are sold pursuant to ST’s terms and conditions of sale in place at the time of order acknowledgement.

Purchasers are solely responsible for the choice, selection, and use of ST products and ST assumes no liability for application assistance or the design of Purchasers’ products.

No license, express or implied, to any intellectual property right is granted by ST herein.

Resale of ST products with provisions different from the information set forth herein shall void any warranty granted by ST for such product.

ST and the ST logo are trademarks of ST. All other product or service names are the property of their respective owners.

Information in this document supersedes and replaces information previously supplied in any prior versions of this document.

© 2018 STMicroelectronics – All rights reserved