
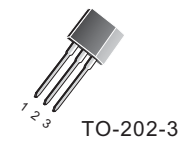


### Description

Passivated, sensitive gate triacs in a plastic envelope, intended for use in general purpose bidirectional switching and phase control applications, where high sensitivity is required in all four quadrants.

<p>Symbol</p> 		<p>Simplified outline</p> 	
Pin	Description		
1	Main terminal 1 (T1)		
2	Main terminal 2 (T2)		
3	gate (G)		
TAB	Main terminal		

### Applications:

- ◆ Motor control
- ◆ Industrial and domestic lighting
- ◆ Heating
- ◆ Static switching

### Features

- ◆ Blocking voltage to 600 V
- ◆ On-state RMS current to 4 A

SYMBOL	PARAMETER	Value	Unit
$V_{DRM}$	Repetitive peak off-state voltages	600	V
$I_{T(RMS)}$	RMS on-state current	4	A
$I_{TSM}$	Non-repetitive peak on-state current	21	A

SYMBOL	PARAMETER	CONDITIONS	MIN	TYP	Value	UNIT
Rth(j-l)	Junction to lead (AC)	-	-	-	15	°C/W
Rth j-a	Junction to ambient	-	-	-	100	°C/W



# Z0405MF

## Sensitive Gate Triacs

HAOPIN MICROELECTRONICS CO.,LTD.

Limiting values in accordance with the Maximum system(IEC 134)

SYMBOL	PARAMETER	CONDITIONS	MIN	Value	UNIT		
$V_{DSM}/V_{RSM}$			-	600	V		
$I_{T(RMS)}$	RMS on-state current	Full sine wave; $T_j=30^\circ\text{C}$	-	4	A		
$I_{TSM}$	Non repetitive surge peak on-state current	full cycle, $T_j$ initial= $25^\circ\text{C}$	F=50Hz	t=20ms	-	20	A
			F=60Hz	t=16.7ms	-	21	A
$I^2t$	$I^2t$ Value for fusing	$T_p=10\text{ms}$	-	2.2	$\text{A}^2\text{S}$		
$DI/dt$	Critical rate of rise of on-state current	$I_G=2 \times I_{GT}, tr \leq 100\text{ns}$	F=120Hz	$T_j=125^\circ\text{C}$	-	20	A/ $\mu\text{s}$
$I_{GM}$	Peak gate current		tp=20us	$T_j=125^\circ\text{C}$	-	1.2	A
$I_{DRM}$	$V_{DRM}=V_{RRM}$			$T_j=25^\circ\text{C}$	-	5	$\mu\text{A}$
$I_{RRM}$	$V_{DRM}=V_{RRM}$			$T_j=125^\circ\text{C}$	-	0.5	mA
$P_{G(AV)}$	Average gate power			$T_j=125^\circ\text{C}$	-	0.2	W
$T_{stg}$	Storage temperature range		-40	150		$^\circ\text{C}$	
$T_j$	Operating junction Temperature range		-40	125		$^\circ\text{C}$	

$T_j=25^\circ\text{C}$  unless otherwise stated

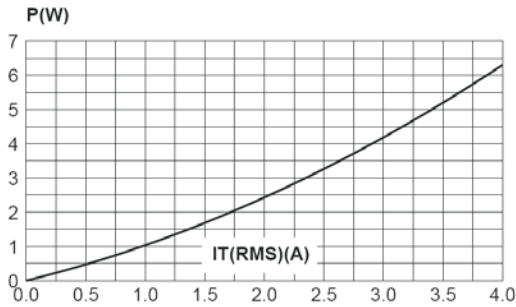
SYMBOL	PARAMETER	CONDITIONS	MIN	TYP	MAX	UNIT	
Static characteristics							
$I_{GT1}$ $V_{GT}$		$V_D=12\text{V}; R_L=33\Omega$	ALL	-	-	5	mA
						ALL	1.3
$I_L$		$I_G=1.2 I_{GT}$	I-III-IV	-	-	10	mA
			II	-	-	15	mA
$I_{H2}$		$I_T=50\text{mA}$	-	-	5	mA	
$V_{GD}$		$V_D=V_{DRM} R_L=3.3\text{K}\Omega T_j=125^\circ\text{C}$	0.2	-	-	V	
$dV/dt2$		$V_D=67\%V_{DRM}$ gate open; $T_j=110^\circ\text{C}$	20	-	-	V/us	
$(Dv/dt)c(2)$		$(DI/dt)c=1.8\text{A/ms}; T_j=110^\circ\text{C}$	1	-	-	V/us	

### Dynamic Characteristics

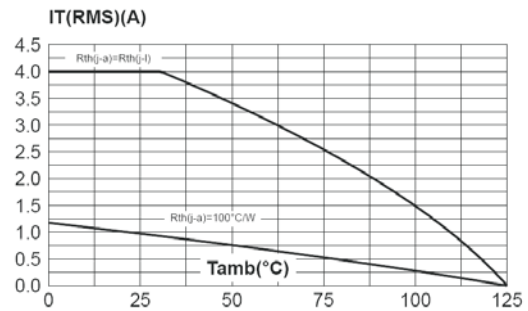
$V_{TM}(2)$	$I_{TM}=5.5\text{A}$ tp=380us	$T_j=25^\circ\text{C}$	-	-	2.0	V
$V_{to}$ $R_d$	Threshold voltage Dynamic resistance	$T_j=125^\circ\text{C}$ $T_j=125^\circ\text{C}$	-	-	0.95 180	V $\text{m}\Omega$

Description

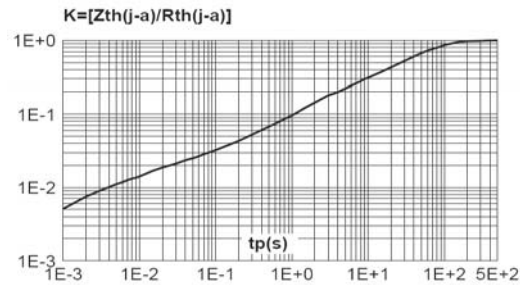
**Fig. 1:** Maximum power dissipation versus RMS on-state current (full cycle).



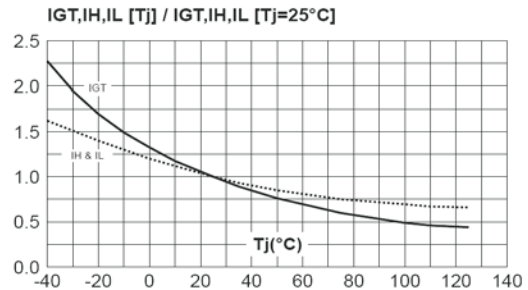
**Fig. 2:** RMS on-state current versus ambient temperature (full cycle).



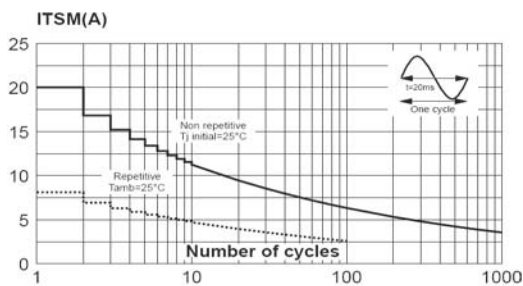
**Fig. 3:** Relative variation of thermal impedance junction to ambient versus pulse duration.



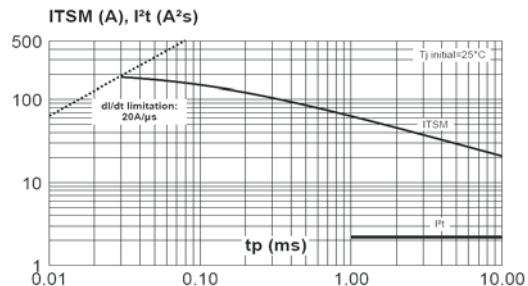
**Fig. 4:** Relative variation of gate trigger current, holding current and latching current versus junction temperature (typical values).



**Fig. 5:** Surge peak on-state current versus number of cycles.

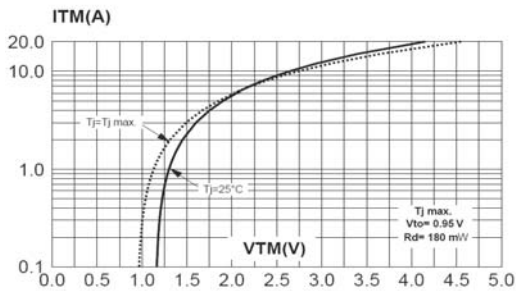


**Fig. 6:** Non-repetitive surge peak on-state current for a sinusoidal pulse with width  $t_p < 10\text{ms}$ , and corresponding value of  $I^2t$ .

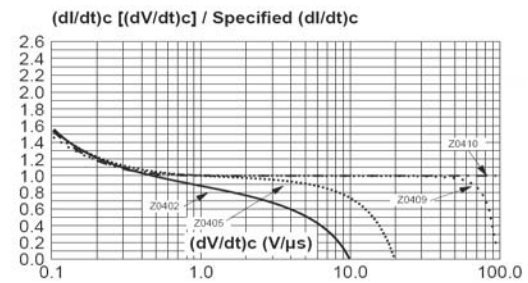


### Description

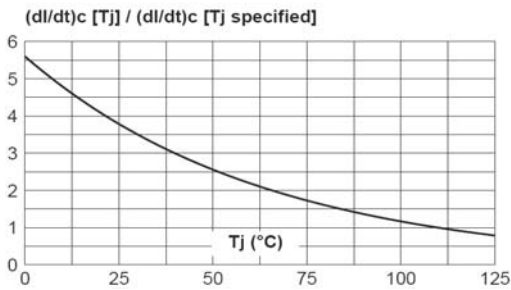
**Fig. 7:** On-state characteristics (maximum values).



**Fig. 8:** Relative variation of critical rate of decrease of main current versus  $(dV/dt)_c$  (typical values).



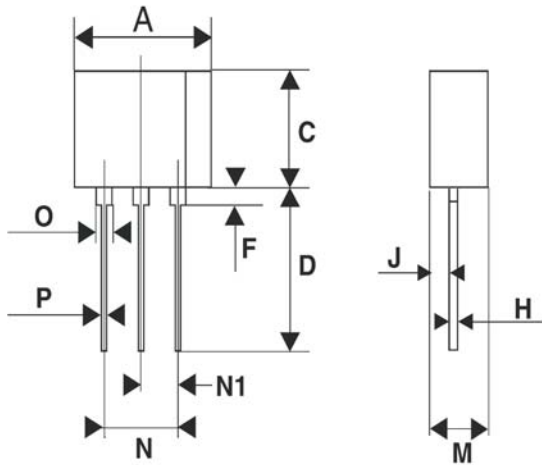
**Fig. 9:** Relative variation of critical rate of decrease of main current versus junction temperature.



MECHANICAL DATA

Dimensions in mm

Net Mass: 0.8g



REF.	DIMENSIONS					
	Millimeters			Inches		
	Min.	Typ.	Max.	Min.	Typ.	Max.
A			10.1			0.398
C		7.3			0.287	
D		10.5			0.413	
F			1.5			0.059
H		0.51			0.020	
J		1.5			0.059	
M		4.5			0.177	
N			5.3			0.209
N1		2.54			0.100	
O			1.4			0.055
P			0.7			0.028