

## USB Dual-Port Power Switch and Current Monitor

### Features

- Dual-Port Power Switches:
  - 2.9V to 5.5V source voltage range
  - 3.0A continuous current per  $V_{BUS}$  port with 40 m $\Omega$  On resistance per switch
  - Independent port power switch enable pins
  - DUAL fault ALERT# active drain output pins
  - Constant Current or Trip mode current limiting behaviors
  - Undervoltage and overvoltage lockout
  - Back-drive, back-voltage protection
  - Auto-recovery fault handling with low test current
  - BOOST# logic output to increase DC-DC converter output under large load conditions
- SMBus 2.0/I<sup>2</sup>C Mode Features:
  - Eight programmable current limits assignable to each power switch
  - Other SMBus addresses available upon request
  - Block read and block write
- Self-Contained Current Monitoring (No External Sense Resistor Required)
- Fully Programmable Per-Port Charge Rationing and Behaviors
- Configurable Per-Port BC1.2  $V_{BUS}$  Discharge Function
- Wide Operating Temperature Range:
  - -40°C to +105°C
- UL Recognized and EN/IEC 60950-1 (CB) Certified
- Passes Automotive AEC-Q100 Reliability Testing

### Description

The UCS2113 is a dual USB port power switch configuration which can provide 3.0A continuous current (3.4A maximum) per  $V_{BUS}$  port with precision overcurrent limiting (OCL), port power switch enables, auto-recovery fault handling, undervoltage and overvoltage lockout, back-drive protection and back-voltage protection, and thermal protection.

The UCS2113 is well suited for both stand-alone and applications having SMBus/I<sup>2</sup>C communications.

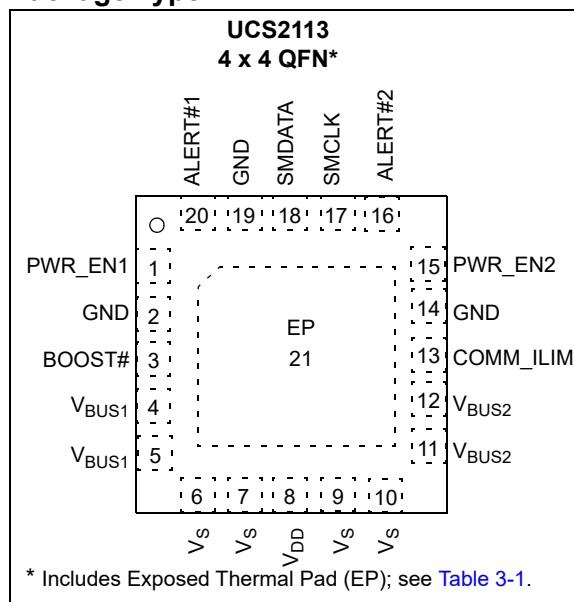
For applications with SMBus, the UCS2113 provides per-port current monitoring and eight programmable current limits per switch, ranging from 0.53A to 3.0A continuous current (3.4A maximum). Per-port charge rationing is also provided ranging from 3.8 mAh to 246.3 Ah.

In stand-alone mode, the UCS2113 provides eight current limits for both switches, ranging from 0.53A + 0.53A to 3A + 3A total continuous current (see [Table 1-1](#)).

Both power switches include an independent  $V_{BUS}$  discharge function and constant current mode current limiting for BC1.2 applications.

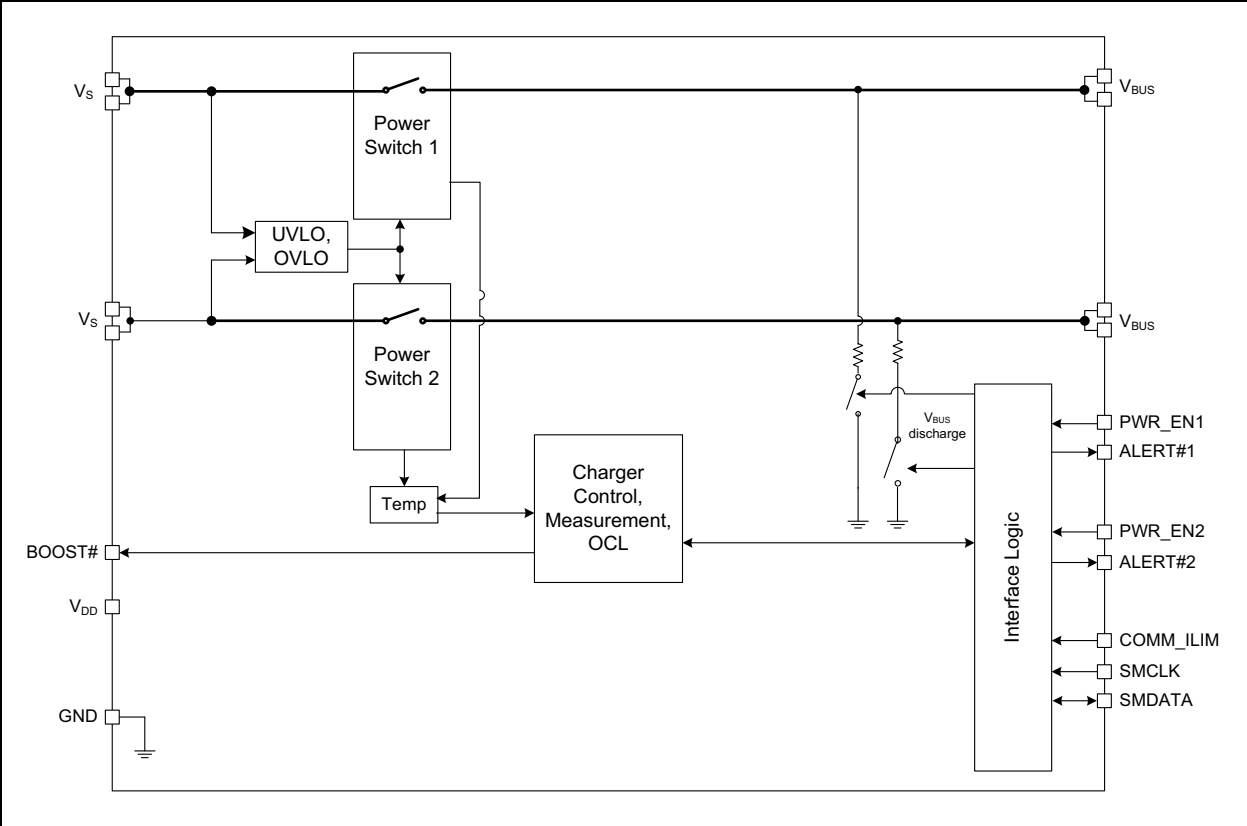
The UCS2113 is available in a 4x4 mm 20-pin QFN package.

### Package Type



# UCS2113

## Block Diagram



## 1.0 ELECTRICAL CHARACTERISTICS

### Absolute Maximum Ratings<sup>(†)</sup>

|   |                                |
|---|--------------------------------|
| Voltage on V <sub>DD</sub> , V <sub>S</sub> , and V <sub>BUS</sub> pins ..... | -0.3 to 6V                     |
| Pull-Up Voltage (V <sub>PULLUP</sub> ) .....                                  | -0.3 to V <sub>DD</sub> + 0.3  |
| Port Power Switch Current .....   | Internally limited             |
| Voltage on any Other Pin to Ground .....                                      | -0.3 to V <sub>DD</sub> + 0.3V |
| Current on any Other Pin .....  | ±10 mA                         |
| Package Power Dissipation .....   | See Table 1-1                  |
| Operating Ambient Temperature Range .....                                     | -40°C to +105°C                |
| Storage Temperature Range .....   | -55°C to +150°C                |

† **Notice:** Stresses above those listed under “Maximum Ratings” may cause permanent damage to the device. This is a stress rating only and functional operation of the device at those or any other conditions above those indicated in the operation listings of this specification is not implied. Exposure to maximum rating conditions for extended periods may affect device reliability.

**TABLE 1-1: POWER DISSIPATION SUMMARY**

| Board            | Package              | θ <sub>JC</sub> | θ <sub>JA</sub> | Derating Factor Above +25°C | T <sub>A</sub> < +25°C Power Rating | T <sub>A</sub> = +70°C Power Rating | T <sub>A</sub> = +85°C Power Rating |
|------------------|----------------------|-----------------|-----------------|-----------------------------|-------------------------------------|-------------------------------------|-------------------------------------|
| High K<br>(Note) | 20-pin QFN<br>4x4 mm | 6 °C/W          | 41 °C/W         | 24.4 mW/°C                  | 2193 mW                             | 1095 mW                             | 729 mW                              |
| Low K<br>(Note)  | 20-pin QFN<br>4x4 mm | 6 °C/W          | 60 °C/W         | 16.67 mW/°C                 | 1498 mW                             | 748 mW                              | 498 mW                              |

**Note:** A High-K board uses a thermal via design with the thermal landing soldered to the PCB ground plane with 0.3 mm (12 mil) diameter vias in a 3x3 matrix (9 total) at 0.5 mm (20 mil) pitch. The board is multilayer with 1-ounce internal power and ground planes and 2-ounce copper traces on top and bottom. A Low-K board is a two-layer board without thermal via design with 2-ounce copper traces on the top and bottom.

**TABLE 1-2: ELECTRICAL SPECIFICATIONS**

| <b>Electrical Characteristics:</b> Unless otherwise specified, V <sub>DD</sub> = 4.5V to 5.5V, V <sub>S</sub> = 2.9V to 5.5V, V <sub>PULLUP</sub> = 3V to 5.5V, T <sub>A</sub> = -40°C to 105°C. All typical values at V <sub>DD</sub> = V <sub>S</sub> = 5V, T <sub>A</sub> = 27°C. |                         |      |      |      |      |   |
|--|-------------------------|------|------|------|------|---|
| Characteristic   | Symbol                  | Min. | Typ. | Max. | Unit | Conditions  |
| <b>Power and Interrupts - DC</b>   |                         |      |      |      |      |   |
| Supply Voltage   | V <sub>DD</sub>         | 4.5  | 5    | 5.5  | V    |   |
| Supply Current in Active (I <sub>DD_ACT</sub> + I <sub>S1_ACT</sub> + I <sub>S2_ACT</sub> )  | I <sub>ACTIVE</sub>     | —    | 700  | —    | µA   | Average current I <sub>BUS</sub> = 0 mA               |
| Supply Current in Sleep (I <sub>DD_SLEEP</sub> + I <sub>S1_SLEEP</sub> + I <sub>S2_SLEEP</sub> )   | I <sub>SLEEP</sub>      | —    | 6    | 20   | µA   | Average current V <sub>PULLUP</sub> ≤ V <sub>DD</sub> |
| <b>Power-On Reset</b>  |                         |      |      |      |      |   |
| V <sub>DD</sub> Low Threshold  | V <sub>DD_TH</sub>      | —    | 4    | 4.3  | V    | V <sub>DD</sub> voltage increasing (Note 1)           |
| V <sub>DD</sub> Low Hysteresis   | V <sub>DD_TH_HYST</sub> | —    | 500  | 600  | mV   | V <sub>DD</sub> voltage decreasing (Note 1)           |

- Note**
- 1: This parameter is characterized, not 100% tested.
  - 2: This parameter is ensured by design and not 100% tested.
  - 3: The current measurement full scale range maximum value is 3.4A. However, the UCS2113 cannot report values above I<sub>LIM</sub> (if I<sub>BUS\_R2MIN</sub> ≤ I<sub>LIM</sub>) or above I<sub>BUS\_R2MIN</sub> (if I<sub>BUS\_R2MIN</sub> > I<sub>LIM</sub> and I<sub>LIM</sub> ≤ 1.6A).

# UCS2113

**TABLE 1-2: ELECTRICAL SPECIFICATIONS (CONTINUED)**

| <b>Electrical Characteristics:</b> Unless otherwise specified, $V_{DD} = 4.5V$ to $5.5V$ , $V_S = 2.9V$ to $5.5V$ , $V_{PULLUP} = 3V$ to $5.5V$ , $T_A = -40^\circ C$ to $105^\circ C$ . All typical values at $V_{DD} = V_S = 5V$ , $T_A = 27^\circ C$ . |                   |      |      |         |         |   |
|---|-------------------|------|------|---------|---------|---|
| Characteristic  | Symbol            | Min. | Typ. | Max.    | Unit    | Conditions  |
| <b>I/O Pins - SMCLK, SMDATA, PWR_EN, ALERT#, BOOST# - DC Parameters</b>   |                   |      |      |         |         |   |
| Output Low Voltage  | $V_{OL}$          | —    | —    | 0.4     | V       | $I_{SINK\_IO} = 8\text{ mA}$<br>SMDATA, ALERT#, BOOST#                          |
| Input High Voltage  | $V_{IH}$          | 2.0  | —    | —       | V       | PWR_EN, SMDATA, SMCLK   |
| Input Low Voltage   | $V_{IL}$          | —    | —    | 0.8     | V       | PWR_EN, SMDATA, SMCLK   |
| Leakage Current   | $I_{LEAK}$        | —    | —    | $\pm 5$ | $\mu A$ | Powered or unpowered<br>$V_{PULLUP} \leq V_{DD}$<br>$T_A < 85^\circ C$ (Note 1) |
| <b>Interrupt Pins - AC Parameters</b>   |                   |      |      |         |         |   |
| ALERT# Pin Blanking Time  | $t_{BLANK}$       | —    | 25   | —       | ms      | Blanking time, coming out of reset  |
| ALERT# Pin Interrupt Masking Time   | $t_{MASK}$        | —    | 5    | —       | ms      |   |
| BOOST# Pin Minimum Assertion Time   | $t_{BOOST\_MAT}$  | —    | 1    | —       | s       |   |
| BOOST# Pin Assertion Current  | $I_{BOOST}$       | —    | 1.9  | —       | A       |   |
| <b>SMBus/I<sup>2</sup>C Timing</b>  |                   |      |      |         |         |   |
| Input Capacitance   | $C_{IN}$          | —    | 5    | —       | pF      |   |
| Clock Frequency   | $f_{SMB}$         | 10   | —    | 400     | kHz     |   |
| Spike Suppression   | $t_{SP}$          | —    | —    | 50      | ns      |   |
| Bus Free Time Stop to Start   | $t_{BUF}$         | 1.3  | —    | —       | $\mu s$ |   |
| Start Setup Time  | $t_{SU:STA}$      | 0.6  | —    | —       | $\mu s$ |   |
| Start Hold Time   | $t_{HD:STA}$      | 0.6  | —    | —       | $\mu s$ |   |
| Stop Setup Time   | $t_{SU:STO}$      | 0.6  | —    | —       | $\mu s$ |   |
| Data Hold Time  | $t_{HD:DAT}$      | 0    | —    | —       | $\mu s$ | When transmitting to the host   |
| Data Hold Time  | $t_{HD:DAT}$      | 0.3  | —    | —       | $\mu s$ | When receiving from the host  |
| Data Setup Time   | $t_{SU:DAT}$      | 0.6  | —    | —       | $\mu s$ |   |
| Clock Low Period  | $t_{LOW}$         | 1.3  | —    | —       | $\mu s$ |   |
| Clock High Period   | $t_{HIGH}$        | 0.6  | —    | —       | $\mu s$ |   |
| Clock/Data Fall Time  | $t_{FALL}$        | —    | —    | 300     | ns      | Min. = $20+0.1C_{LOAD}$ ns<br>(Note 1)  |
| Clock/Data Rise Time  | $t_{RISE}$        | —    | —    | 300     | ns      | Min. = $20+0.1C_{LOAD}$ ns<br>(Note 1)  |
| Capacitive Load   | $C_{LOAD}$        | —    | —    | 400     | pF      | Per bus line (Note 1)   |
| Timeout   | $t_{TIMEOUT}$     | 25   | —    | 35      | ms      | Disabled by default (Note 1)  |
| Idle Reset  | $t_{IDLE\_RESET}$ | 350  | —    | —       | $\mu s$ | Disabled by default (Note 1)  |

**Note 1:** This parameter is characterized, not 100% tested.

**Note 2:** This parameter is ensured by design and not 100% tested.

**Note 3:** The current measurement full scale range maximum value is 3.4A. However, the UCS2113 cannot report values above  $I_{LIM}$  (if  $I_{BUS\_R2MIN} \leq I_{LIM}$ ) or above  $I_{BUS\_R2MIN}$  (if  $I_{BUS\_R2MIN} > I_{LIM}$  and  $I_{LIM} \leq 1.6A$ ).

**TABLE 1-2: ELECTRICAL SPECIFICATIONS (CONTINUED)**

| Electrical Characteristics: Unless otherwise specified, $V_{DD} = 4.5V$ to $5.5V$ , $V_S = 2.9V$ to $5.5V$ , $V_{PULLUP} = 3V$ to $5.5V$ , $T_A = -40^{\circ}C$ to $105^{\circ}C$ . All typical values at $V_{DD} = V_S = 5V$ , $T_A = 27^{\circ}C$ . |                      |      |      |      |             |  |
|---|----------------------|------|------|------|-------------|--|
| Characteristic  | Symbol               | Min. | Typ. | Max. | Unit        | Conditions   |
| <b>Port Power Switch</b>  |                      |      |      |      |             |  |
| <b>Port Power Switch - DC Parameter</b>   |                      |      |      |      |             |  |
| Overvoltage Lockout   | $V_{S\_OV}$          | —    | 6    | —    | V           | Note 2   |
| $V_S$ Low Threshold   | $V_{S\_UVLO}$        | —    | 2.5  | —    | V           | Note 2   |
| $V_S$ Low Hysteresis  | $V_{S\_UVLO\_HYST}$  | —    | 100  | —    | mV          | Note 2   |
| On Resistance   | $R_{ON\_PSW}$        | —    | 40   | —    | m $\Omega$  | $4.75V < V_S < 5.25V$  |
| $V_S$ Leakage Current   | $I_{LEAK\_VS}$       | —    | —    | 5    | $\mu A$     | Sleep state into $V_S$ pin on one channel (Note 1)   |
| Back-Voltage Protection Threshold   | $V_{BV\_TH}$         | —    | 150  | —    | mV          | $V_{BUS} > V_S$<br>$V_S > V_{S\_UVLO}$   |
| Leakage Current   | $I_{LKG\_1}$         | —    | 0    | 3    | $\mu A$     | $V_{DD} < V_{DD\_TH}$ ,<br>Leakage current from $V_{BUS}$ pins to the $V_{DD}$ and the $V_S$ pins (Note 1)                       |
|   | $I_{LKG\_2}$         | —    | 0    | 2    | $\mu A$     | $V_{DD} > V_{DD\_TH}$ ,<br>Leakage current from $V_{BUS}$ pins to the $V_S$ pins, when the power switch is open                  |
| Selectable Current Limits   | $I_{LIM1}$           | —    | 530  | —    | mA          | $I_{LIM}$ Resistor = 0 or 47 k $\Omega$ (530 mA setting)   |
|   | $I_{LIM2}$           | —    | 960  | —    | mA          | $I_{LIM}$ Resistor = 10 k $\Omega$ or 56 k $\Omega$ (960 mA setting)   |
|   | $I_{LIM3}$           | —    | 1070 | —    | mA          | $I_{LIM}$ Resistor = 12 k $\Omega$ or 68 k $\Omega$ (1070 mA setting)  |
|   | $I_{LIM4}$           | —    | 1280 | —    | mA          | $I_{LIM}$ Resistor = 15 k $\Omega$ or 82 k $\Omega$ (1280 mA setting)  |
|   | $I_{LIM5}$           | —    | 1600 | —    | mA          | $I_{LIM}$ Resistor = 18 k $\Omega$ or 100 k $\Omega$ (1600 mA setting)   |
|   | $I_{LIM6}$           | —    | 2130 | —    | mA          | $I_{LIM}$ Resistor = 22 k $\Omega$ or 120 k $\Omega$ (2130 mA setting)   |
|   | $I_{LIM7}$           | 2500 | 2670 | 2900 | mA          | $I_{LIM}$ Resistor = 27 k $\Omega$ or 150 k $\Omega$ (2670 mA setting)   |
|   | $I_{LIM8}$           | 3000 | 3200 | 3400 | mA          | $I_{LIM}$ Resistor = 33 k $\Omega$ or $V_{DD}$ (3200 mA setting)   |
| Pin Wake Time   | $t_{PIN\_WAKE}$      | —    | 3    | —    | ms          |  |
| SMBus Wake Time   | $t_{SMB\_WAKE}$      | —    | 4    | —    | ms          |  |
| Idle Sleep Time   | $t_{IDLE\_SLEEP}$    | —    | 200  | —    | ms          |  |
| First Thermal Shutdown Stage Threshold  | $T_{TSD\_LOW}$       | —    | 120  | —    | $^{\circ}C$ | Die Temperature at which the power switch will open if it is in constant current mode  |
| First Thermal Shutdown Stage Hysteresis   | $T_{TSD\_LOW\_HYST}$ | —    | 10   | —    | $^{\circ}C$ | Hysteresis for $T_{TSD\_LOW}$ functionality. Temperature must drop by this value before any of the power switches can be closed. |

**Note 1:** This parameter is characterized, not 100% tested.

**Note 2:** This parameter is ensured by design and not 100% tested.

**Note 3:** The current measurement full scale range maximum value is 3.4A. However, the UCS2113 cannot report values above  $I_{LIM}$  (if  $I_{BUS\_R2MIN} \leq I_{LIM}$ ) or above  $I_{BUS\_R2MIN}$  (if  $I_{BUS\_R2MIN} > I_{LIM}$  and  $I_{LIM} \leq 1.6A$ ).

# UCS2113

**TABLE 1-2: ELECTRICAL SPECIFICATIONS (CONTINUED)**

| <b>Electrical Characteristics:</b> Unless otherwise specified, $V_{DD} = 4.5V$ to $5.5V$ , $V_S = 2.9V$ to $5.5V$ , $V_{PULLUP} = 3V$ to $5.5V$ , $T_A = -40^{\circ}C$ to $105^{\circ}C$ . All typical values at $V_{DD} = V_S = 5V$ , $T_A = 27^{\circ}C$ . |                           |      |      |      |             |   |
|--|---------------------------|------|------|------|-------------|---|
| Characteristic   | Symbol                    | Min. | Typ. | Max. | Unit        | Conditions  |
| Second Thermal Shutdown Stage Threshold  | $T_{TSD\_HIGH}$           | —    | 135  | —    | $^{\circ}C$ | Die Temperature at which both power switches will open  |
| Second Thermal Shutdown Stage Hysteresis   | $T_{TSD\_HIGH\_HYST}$     | —    | 25   | —    | $^{\circ}C$ | Hysteresis for $T_{TSD\_HIGH}$ functionality. Temperature must drop by this value before any of the power switches can be closed. |
| Auto-Recovery Test Current   | $I_{TEST}$                | —    | 190  | —    | mA          | Portable device attached, $V_{BUS} = 0V$ , Die temp $< T_{TSD}$   |
| Auto-Recovery Test Voltage   | $V_{TEST}$                | —    | 750  | —    | mV          | Portable device attached, $V_{BUS} = 0V$ before application, Die temp $< T_{TSD}$<br>Programmable, 250 - 1000 mV, default listed  |
| Discharge Impedance  | $R_{DISCHARGE}$           | —    | 100  | —    | $\Omega$    |   |
| <b>Port Power Switch - AC Parameters</b>   |                           |      |      |      |             |   |
| Turn-On Delay  | $t_{ON\_PSW}$             | —    | 0.9  | —    | ms          | PWR_EN active toggle to switch on time, $V_{BUS}$ discharge not active  |
| Turn-Off Time  | $t_{OFF\_PSW\_INA}$       | —    | 0.75 | —    | ms          | PWR_EN inactive toggle to switch off time<br>$C_{BUS} = 120 \mu F$  |
| Turn-Off Time  | $t_{OFF\_PSW\_ERR}$       | —    | 1    | —    | ms          | Over-current Error, $V_{BUS}$ Min Error, or Discharge Error to switch off<br>$C_{BUS} = 120 \mu F$                                |
| Turn-Off Time  | $t_{OFF\_PSW\_ERR1}$      | —    | 100  | —    | ns          | TSD or Back-drive Error to switch off<br>$C_{BUS} = 120 \mu F$  |
| $V_{BUS}$ Output Rise Time   | $t_{R\_BUS}$              | —    | 1.1  | —    | ms          | Measured from 10% to 90% of $V_{BUS}$ , $C_{LOAD} = 220 \mu F$<br>$I_{LIM} = 1.0A$  |
| Soft Turn-On Rate  | $\Delta I_{BUS}/\Delta t$ | —    | 100  | —    | mA/ $\mu s$ |   |
| Temperature Update Time  | $t_{DC\_TEMP}$            | —    | 200  | —    | ms          |   |
| Short-Circuit Response Time  | $t_{SHORT\_LIM}$          | —    | 1.5  | —    | $\mu s$     | Time from detection of short to current limit applied.<br>No $C_{BUS}$ applied  |
| Short-Circuit Detection Time   | $t_{SHORT}$               | —    | 6    | —    | ms          | Time from detection of short to port power switch disconnect and ALERT# pin assertion   |
| Latched Mode Cycle Time  | $t_{UL}$                  | —    | 7    | —    | ms          | From PWR_EN edge transition from inactive to active to begin error recovery   |

- Note 1:** This parameter is characterized, not 100% tested.  
**Note 2:** This parameter is ensured by design and not 100% tested.  
**Note 3:** The current measurement full scale range maximum value is 3.4A. However, the UCS2113 cannot report values above  $I_{LIM}$  (if  $I_{BUS\_R2MIN} \leq I_{LIM}$ ) or above  $I_{BUS\_R2MIN}$  (if  $I_{BUS\_R2MIN} > I_{LIM}$  and  $I_{LIM} \leq 1.6A$ ).

**TABLE 1-2: ELECTRICAL SPECIFICATIONS (CONTINUED)**

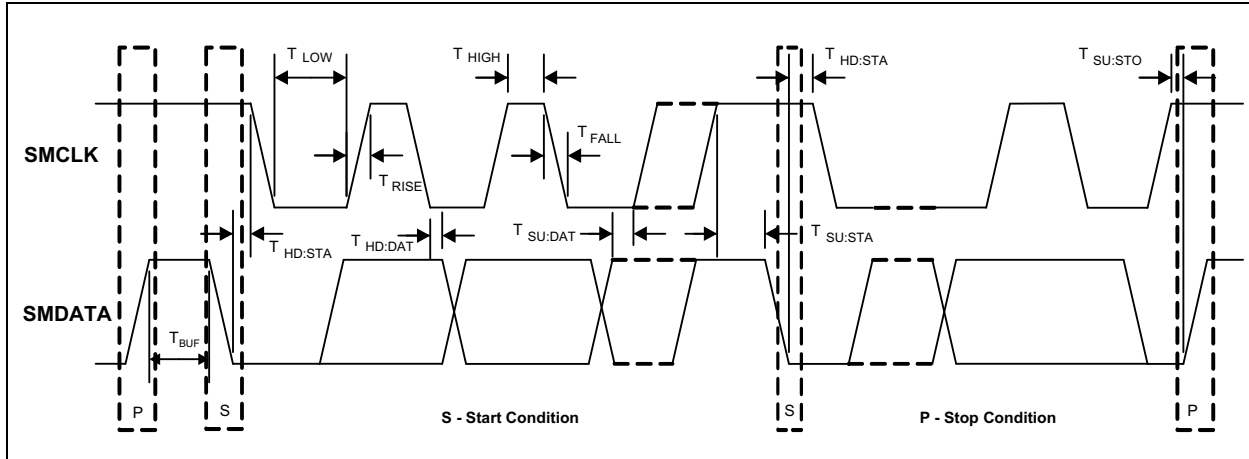
| <b>Electrical Characteristics:</b> Unless otherwise specified, $V_{DD} = 4.5V$ to $5.5V$ , $V_S = 2.9V$ to $5.5V$ , $V_{PULLUP} = 3V$ to $5.5V$ , $T_A = -40^{\circ}C$ to $105^{\circ}C$ . All typical values at $V_{DD} = V_S = 5V$ , $T_A = 27^{\circ}C$ . |                     |      |           |      |      |  |
|--|---------------------|------|-----------|------|------|--|
| Characteristic   | Symbol              | Min. | Typ.      | Max. | Unit | Conditions   |
| Auto-Recovery Mode Cycle Time  | $t_{CYCLE}$         | —    | 25        | —    | ms   | Time delay before error condition check. Programmable 15-50 ms, default listed                                     |
| Auto-Recovery Delay  | $t_{TST}$           | —    | 20        | —    | ms   | Portable device attached, $V_{BUS}$ must be $\geq V_{TEST}$ after this time. Programmable 10-25 ms, default listed |
| Discharge Time   | $t_{DISCHARGE}$     | —    | 200       | —    | ms   | Amount of time discharge resistor applied. Programmable 100-400 ms, default listed                                 |
| <b>Port Power Switch Operation With Trip Mode Current Limiting</b>   |                     |      |           |      |      |  |
| Region 2 Current Keep-Out  | $I_{BUS\_R2MIN\_1}$ | —    | —         | 0.1  | A    | Note 2   |
| Minimum $V_{BUS}$ Allowed at Output  | $V_{BUS\_MIN\_1}$   | 2.0  | —         | —    | V    | Note 2   |
| <b>Port Power Switch Operation With Constant Current Limiting (Variable Slope)</b>   |                     |      |           |      |      |  |
| Region 2 Current Keep-Out  | $I_{BUS\_R2MIN}$    | —    | —         | 2.13 | A    | Note 2   |
| Minimum $V_{BUS}$ Allowed at Output  | $V_{BUS\_MIN}$      | 2.0  | —         | —    | V    | Note 2   |
| <b>Current Measurement - DC</b>  |                     |      |           |      |      |  |
| Current Measurement Range  | $I_{BUS\_M}$        | 0    | —         | 3400 | mA   | Range (Note 2 and Note 3)  |
| Reported Current Measurement Resolution  | $\Delta I_{BUS\_M}$ | —    | 13.3      | —    | mA   | 1 LSB  |
| Current Measurement Accuracy   |                     | —    | $\pm 2$   | —    | %    | $200\text{ mA} < I_{BUS} < I_{LIM}$  |
|  |                     | —    | $\pm 2$   | —    | LSB  | $I_{BUS} < 200\text{ mA}$  |
| <b>Current Measurement - AC</b>  |                     |      |           |      |      |  |
| Sampling Rate  | —                   | —    | 1.1       | —    | ms   | Note 2   |
| Conversion Time Both Channels  | $t_{CONV}$          | —    | 2.2       | —    | ms   | All registers updated in digital (Note 2)  |
| <b>Charge Rationing - DC</b>   |                     |      |           |      |      |  |
| Accumulated Current Measurement Accuracy   | —                   | —    | $\pm 4.5$ | —    | %    |  |
| <b>Charge Rationing - AC</b>   |                     |      |           |      |      |  |
| Current Measurement Update Time  | $t_{PCYCLE}$        | —    | 1         | —    | s    |  |

**Note 1:** This parameter is characterized, not 100% tested.

**Note 2:** This parameter is ensured by design and not 100% tested.

**Note 3:** The current measurement full scale range maximum value is 3.4A. However, the UCS2113 cannot report values above  $I_{LIM}$  (if  $I_{BUS\_R2MIN} \leq I_{LIM}$ ) or above  $I_{BUS\_R2MIN}$  (if  $I_{BUS\_R2MIN} > I_{LIM}$  and  $I_{LIM} \leq 1.6A$ ).

# UCS2113



**FIGURE 1-1:** SMBus Timing.

**TABLE 1-3: TEMPERATURE SPECIFICATIONS**

| Parameters   | Sym.  | Min. | Typ. | Max. | Units | Conditions |
|--|-------|------|------|------|-------|------------|
| <b>Temperature Ranges</b>  |       |      |      |      |       |            |
| Operating Temperature Range  | $T_A$ | -40  | —    | +105 | °C    |            |
| Operating Junction Temperature                                     | $T_J$ | -40  | —    | +125 | °C    |            |
| Storage Temperature Range  | $T_A$ | -55  | —    | +150 | °C    |            |
| <b>Thermal Package Resistances - see <a href="#">Table 1-1</a></b> |       |      |      |      |       |            |



## 1.1 ESD and Transient Performance

**TABLE 1-4: ESD RATINGS**

| ESD Specification                                   | Rating or Value |
|---|-----------------|
| Human Body Model (JEDEC JESD22-A114) - All pins     | 8 kV            |
| Charged Device Model (JEDEC JESD22-C101) - All pins | 500V            |

### 1.1.1 HUMAN BODY MODEL (HBM) PERFORMANCE

HBM testing verifies the ability to withstand ESD strikes, like those that occur during handling and manufacturing, and is done without power applied to the IC. To pass the test, the device must have no change in operation or performance due to the event.

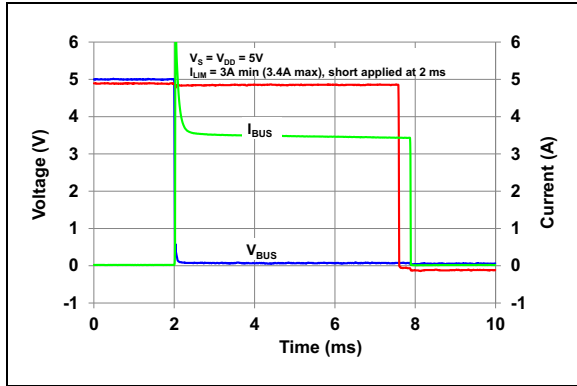
### 1.1.2 CHARGED DEVICE MODEL (CDM) PERFORMANCE

CDM testing verifies the ability to withstand ESD strikes, like those that occur during handling and assembly, with pick-and-place-style machinery and is done without power applied to the IC. To pass the test, the device must have no change in operation or performance due to the event.

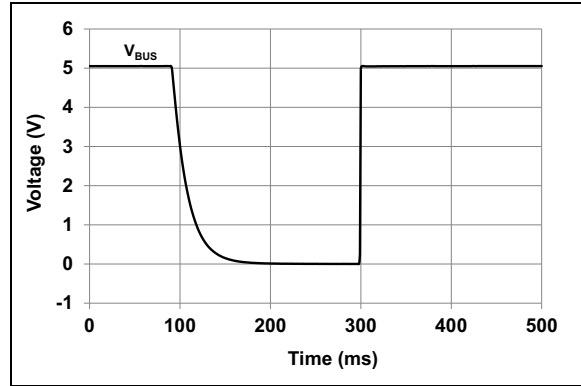
## 2.0 TYPICAL PERFORMANCE CURVES

**Note:** The graphs and tables provided following this note are a statistical summary based on a limited number of samples and are provided for informational purposes only. The performance characteristics listed herein are not tested or guaranteed. In some graphs or tables, the data presented may be outside the specified operating range (e.g., outside specified power supply range) and therefore outside the warranted range.

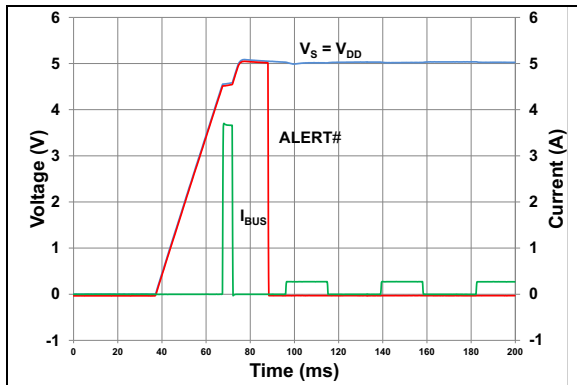
**Note:** Unless otherwise indicated,  $V_{DD} = V_S = 5V$ ,  $T_A = +27^\circ C$ .



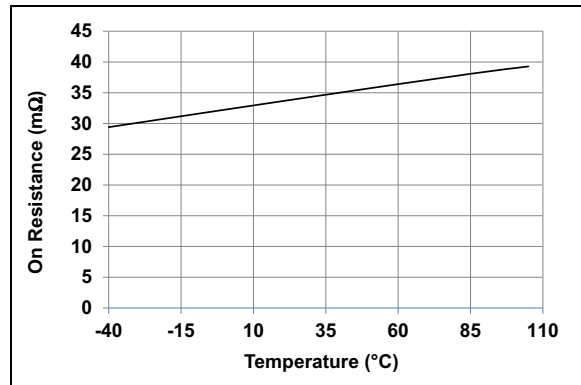
**FIGURE 2-1:** Short Applied After Power-Up.



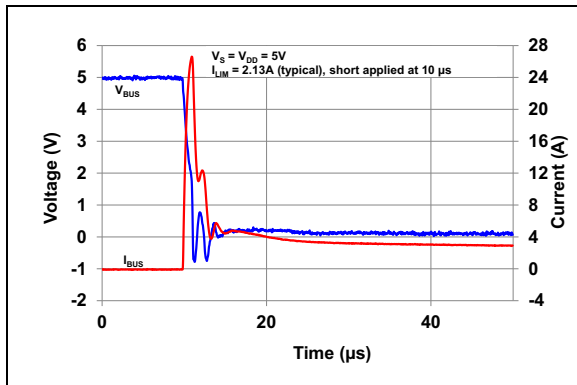
**FIGURE 2-4:**  $V_{BUS}$  Discharge Behavior.



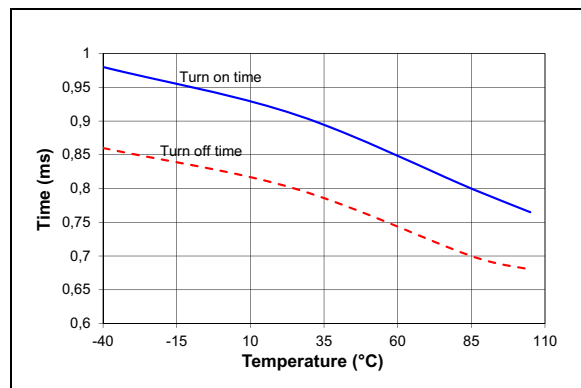
**FIGURE 2-2:** Power-Up Into a Short.



**FIGURE 2-5:** Power Switch On Resistance vs. Temperature.

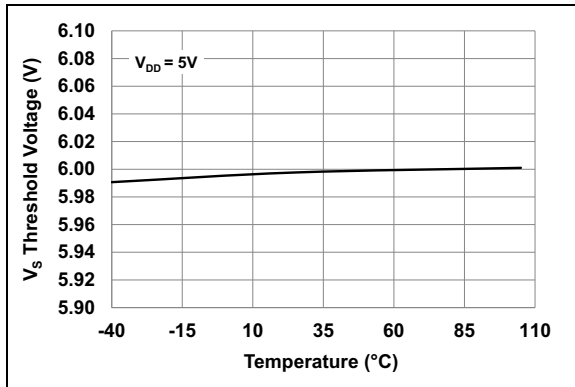


**FIGURE 2-3:** Internal Power Switch Short Response.

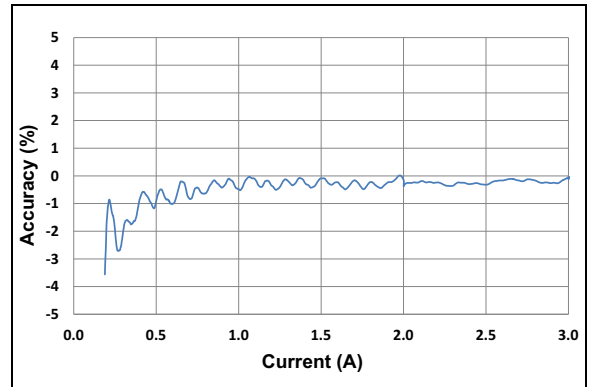


**FIGURE 2-6:** Power Switch On/Off Time vs. Temperature.

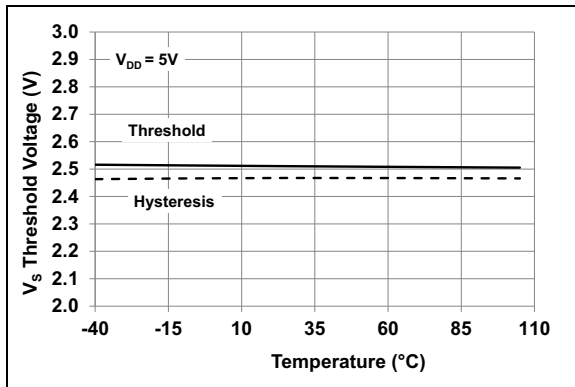
**Note:** Unless otherwise indicated,  $V_{DD} = V_S = 5V$ ,  $T_A = +27^\circ C$ .



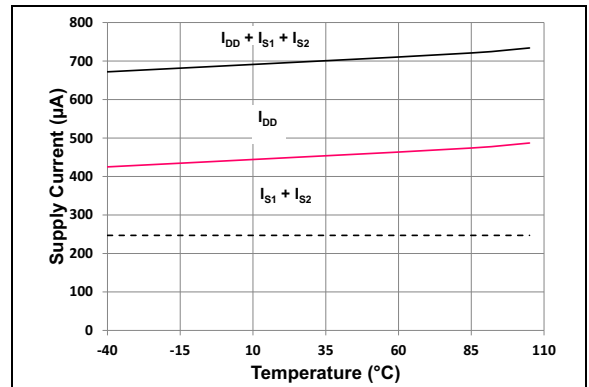
**FIGURE 2-7:**  $V_S$  Overtolerance Threshold vs. Temperature.



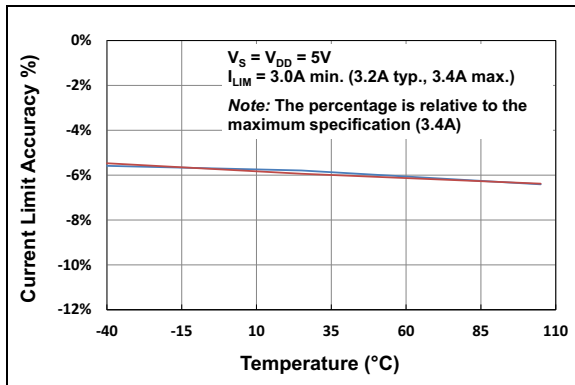
**FIGURE 2-10:**  $I_{BUS}$  Measurement Accuracy.



**FIGURE 2-8:**  $V_S$  Undervoltage Threshold vs. Temperature.

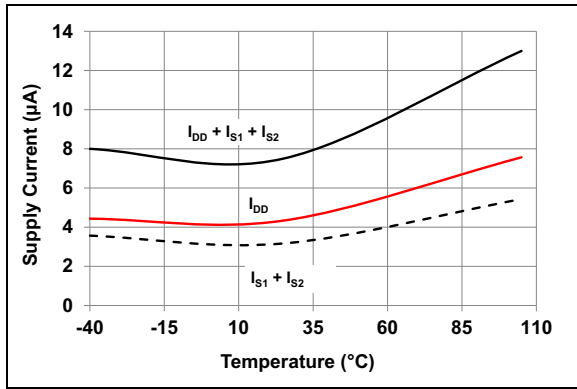


**FIGURE 2-11:** Active State Current vs. Temperature (both channels on,  $PWR\_EN1 = PWR\_EN2 = 1$ ).

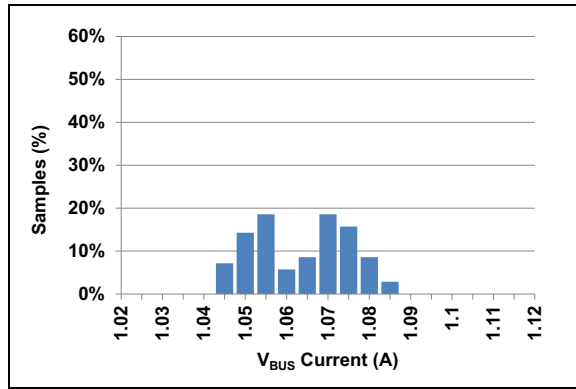


**FIGURE 2-9:** Trip Current Limit Operation vs. Temperature.

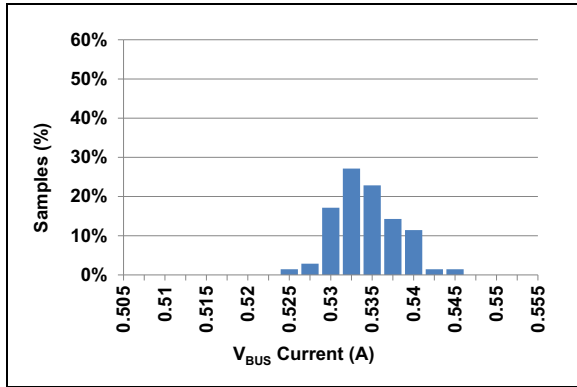
Note: Unless otherwise indicated,  $V_{DD} = V_S = 5V$ ,  $T_A = +27^\circ C$ .



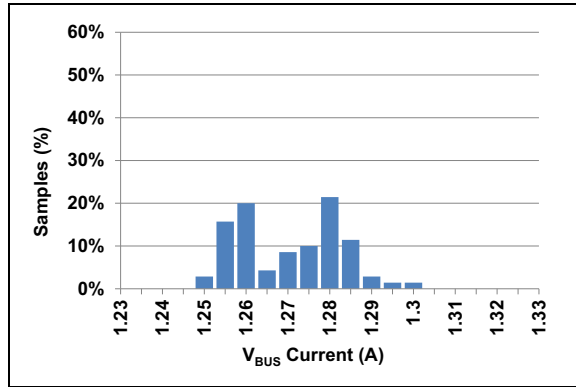
**FIGURE 2-12:** Sleep State Current vs. Temperature.



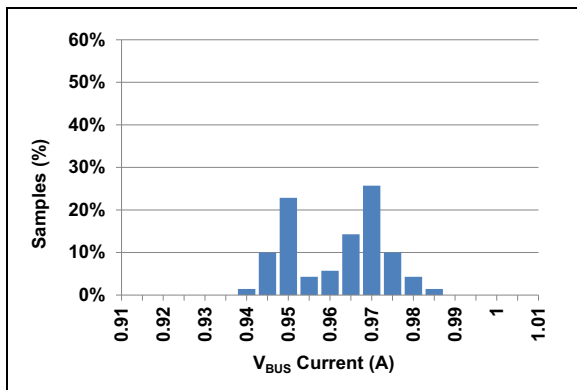
**FIGURE 2-15:** ILIM3 Trip Current Distribution<sup>(1)</sup>.



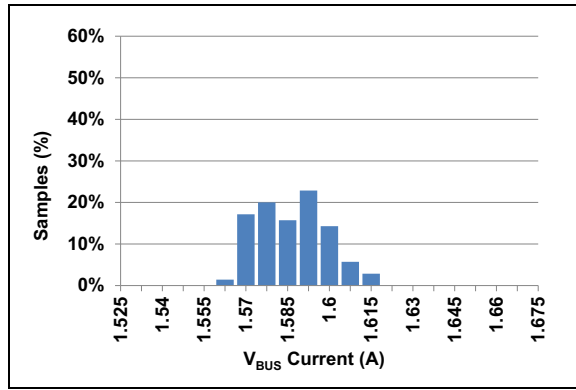
**FIGURE 2-13:** ILIM1 Trip Current Distribution.



**FIGURE 2-16:** ILIM4 Trip Current Distribution<sup>(1)</sup>.



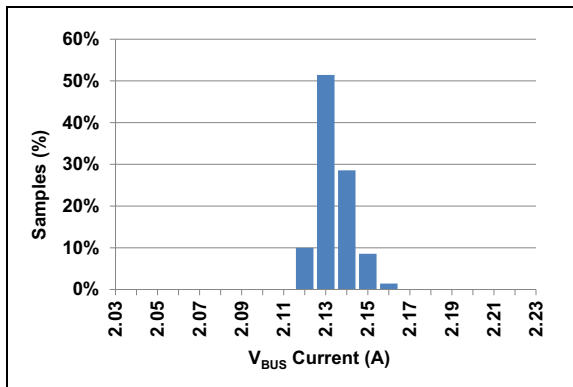
**FIGURE 2-14:** ILIM2 Trip Current Distribution<sup>(1)</sup>.



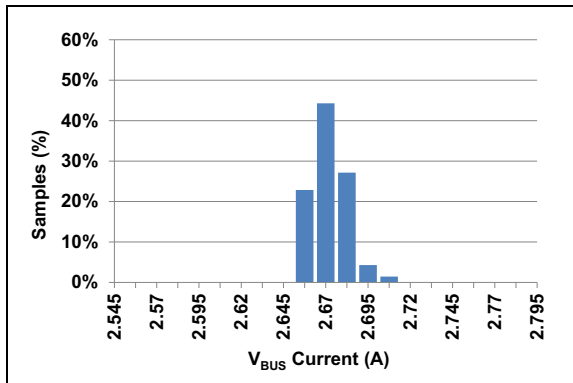
**FIGURE 2-17:** ILIM5 Trip Current Distribution<sup>(1)</sup>.

**Note 1:** The histogram aspect is caused by a mixture of two normal distributions, corresponding to the two  $V_{BUS}$  channels.

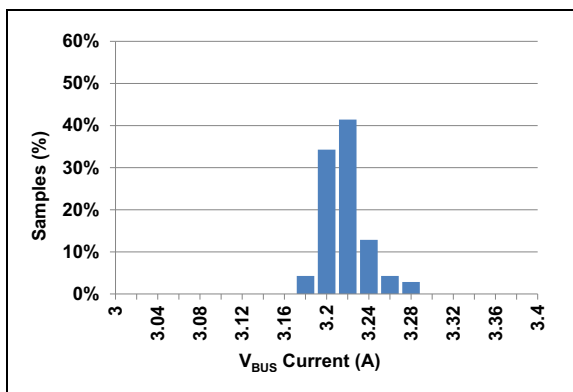
**Note:** Unless otherwise indicated,  $V_{DD} = V_S = 5V$ ,  $T_A = +27^\circ C$ .



**FIGURE 2-18:** ILIM6 Trip Current Distribution.



**FIGURE 2-19:** ILIM7 Trip Current Distribution.



**FIGURE 2-20:** ILIM8 Trip Current Distribution.

**Note 1:** The histogram aspect is caused by a mixture of two normal distributions, corresponding to the two  $V_{BUS}$  channels.

# UCS2113

## 3.0 PIN DESCRIPTION

Descriptions of the pins are listed in [Table 3-1](#).

**TABLE 3-1: PIN FUNCTION TABLE**

| UCS2113<br>4x4 QFN | Symbol     | Function   | Pin Type           | Connection Type if Pin<br>Not Used   |
|--------------------|------------|--|--------------------|--|
| 1                  | PWR_EN1    | Port power switch enable #1  | DI                 | Connect to ground or $V_{DD}$<br>(depending on the polarity<br>decoded via COMM_ILIM<br>pin) |
| 2                  | GND        | Ground   | Power              | N/A  |
| 3                  | BOOST#     | Logic output for DC-DC converter voltage<br>increase (requires pull-up resistor)                 | OD                 | Connect to ground  |
| 4, 5               | $V_{BUS1}$ | Port power switch #1 output (requires both<br>pins tied together)                                | High Power,<br>AIO | Leave open   |
| 6, 7               | $V_S$      | Voltage input to port power switch $V_{BUS1}$<br>(requires both pins<br>tied together)           | High Power,<br>AIO | Connect to ground  |
| 8                  | $V_{DD}$   | Common supply voltage  | Power              | N/A  |
| 9, 10              | $V_S$      | Voltage input to port power switch $V_{BUS2}$<br>(requires both pins<br>tied together)           | High Power,<br>AIO | Connect to ground  |
| 11, 12             | $V_{BUS2}$ | Port power switch #2 output (requires both<br>pins tied together)                                | High Power,<br>AIO | Leave open   |
| 13                 | COMM_ILIM  | Enables SMBus or Stand-Alone mode at<br>power-up. Hardware strap for maximum cur-<br>rent limit. | AIO                | N/A  |
| 14                 | GND        | Ground   | Power              | N/A  |
| 15                 | PWR_EN2    | Port power switch enable #2  | DI                 | Connect to ground or $V_{DD}$<br>(depending on the polarity<br>decoded via COMM_ILIM<br>pin) |
| 16                 | ALERT#2    | Output fault ALERT for $V_{BUS2}$ (requires<br>pull-up resistor)                                 | OD                 | Connect to ground  |
| 17                 | SMCLK      | SMCLK - SMBus clock input (requires pull-up<br>resistor)   | DI                 | Connect to $V_{PULLUP}$ (or to<br>ground in Stand-Alone<br>mode)                             |
| 18                 | SMDATA     | SMDATA - SMBus data input/output (requires<br>pull-up resistor)                                  | DIOD               | Connect to $V_{PULLUP}$ (or to<br>ground in Stand-Alone<br>mode)                             |
| 19                 | GND        | Ground   | Power              | N/A  |
| 20                 | ALERT#1    | Output fault ALERT for $V_{BUS1}$ (requires<br>pull-up resistor)                                 | OD                 | Connect to ground  |
| 21                 | EP         | Exposed thermal pad. Must be connected to<br>electrical ground.                                  | EP                 | N/A  |

**TABLE 3-2: PIN TYPES**

| <b>Pin Type</b> | <b>Description</b>   |
|-----------------|--|
| <b>Power</b>    | This pin is used to supply power or ground to the device   |
| <b>Hi-Power</b> | This pin is a high-current pin   |
| <b>AIO</b>      | Analog Input/Output - this pin is used as an I/O for analog signals  |
| <b>DI</b>       | Digital Input - this pin is used as a digital input  |
| <b>DIOD</b>     | Open-Drain Digital Input/Output - this pin is bidirectional. It is open-drain and requires a pull-up resistor. |
| <b>OD</b>       | Open-Drain Digital Output - used as a digital output. It is open-drain and requires a pull-up resistor.        |
| EP              | Exposed thermal pad  |

# UCS2113

## 4.0 TERMS AND ABBREVIATIONS

**Note:** The PWR\_EN1 and PWR\_EN2 pins each have configuration bits (“<pin name>\_S” in [General Configuration 1 register \(Address 11h\)](#) and [General Configuration 2 register \(Address 12h\)](#)) that may be used to perform the same function as the external pin state. These bits are accessed via the SMBus/I<sup>2</sup>C and are OR'd with the respective pin. This OR'd combination of pin state and register bit is referenced as the <pin name> control.

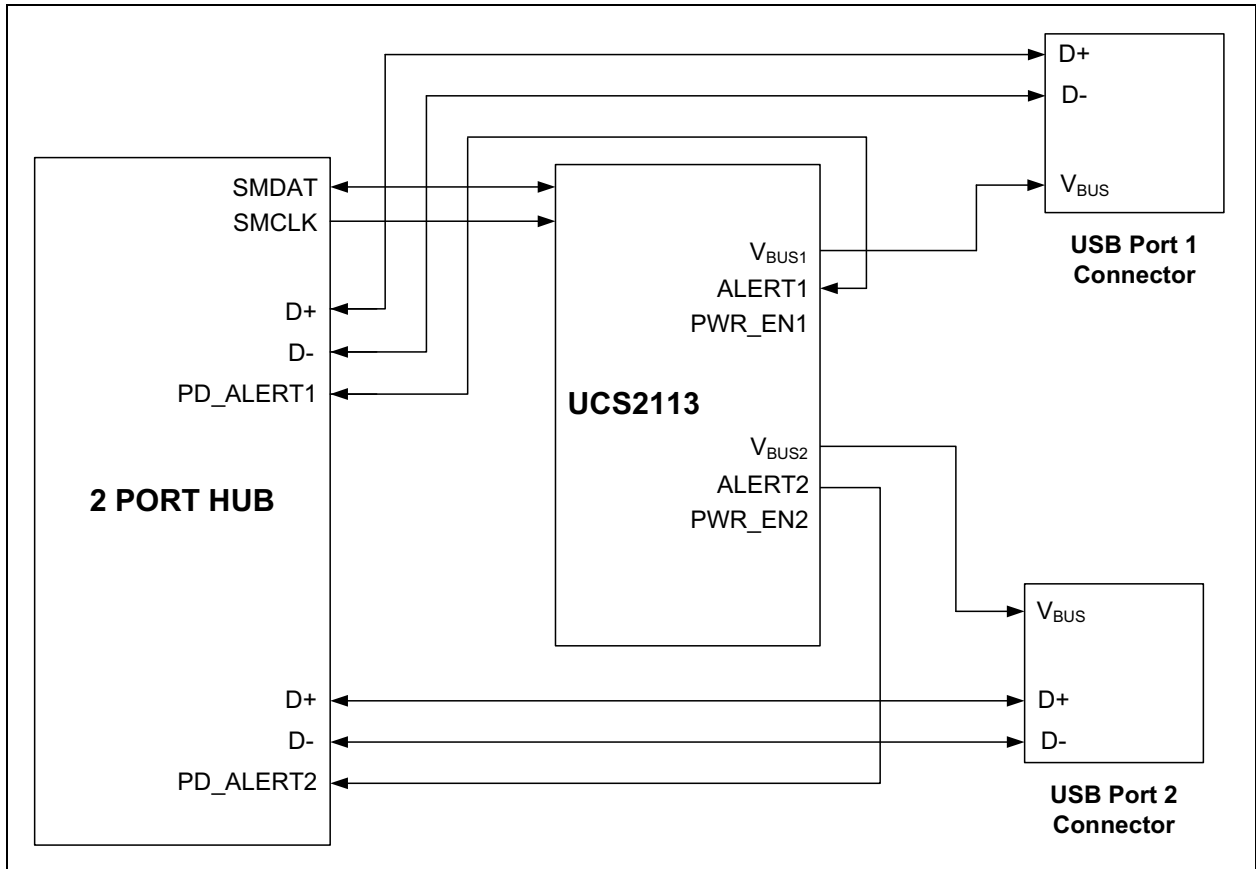
**TABLE 4-1: TERMS AND ABBREVIATIONS**

| Term/Abbreviation      | Description   |
|------------------------|---|
| CC                     | Constant Current  |
| Current Limiting Mode  | Determines the action that is performed when the I <sub>BUS</sub> current reaches the I <sub>LIM</sub> threshold. Trip opens the port power switch. Constant Current (variable slope) allows V <sub>BUS</sub> to be dropped by the portable device.   |
| I <sub>BUS_R2MIN</sub> | Current limiter mode boundary   |
| I <sub>LIM</sub>       | The I <sub>BUS</sub> current threshold used in current limiting. In Trip mode, when I <sub>LIM</sub> is reached, the port power switch is opened. In Constant Current mode, when the current exceeds I <sub>LIM</sub> , operation continues at a reduced voltage and increased current; if V <sub>BUS</sub> voltage drops below V <sub>BUS_MIN</sub> , the port power switch is opened. |
| OCL                    | Overcurrent limit   |
| POR                    | Power-on Reset  |
| Portable Device        | USB device attached to the USB port   |
| Stand-Alone Mode       | Indicates that the communications protocol is not active and all communications between the UCS2113 and a controller are done via the external pins only (PWR_EN1 and PWR_EN2 as inputs, and ALERT1# and ALERT2# as outputs)  |



## 5.0 GENERAL DESCRIPTION

The UCS2113 is a dual-port power switch. Two USB power ports are supported with current limits up to 3.0A continuous current (3.4A maximum) each. Selectable and programmable current limiting configurations are also available to the application. A typical block diagram is shown in [Figure 5-1](#).



**FIGURE 5-1:** Typical USB Application.

# UCS2113

## 5.1 UCS2113 Power States

Power states are indicators of the device's current consumption in the system and the functionality of the digital logic. [Table 5-1](#) details the UCS2113 power states.

**TABLE 5-1: POWER STATES DESCRIPTION**

| State         | Description   |
|---------------|---|
| <b>Off</b>    | This power state is entered when the voltage at the $V_{DD}$ pin voltage is $< V_{DD\_TH}$ . In this state, the device is considered "off". The UCS2113 will not retain its digital states and register contents nor respond to SMBus/I <sup>2</sup> C communications. The port power switch will be off. See <a href="#">Section 5.1.1 "Off State Operation"</a> .   |
| <b>Sleep</b>  | This is the lowest power state available. While in this state, the UCS2113 will retain digital functionality and wake to respond to SMBus/I <sup>2</sup> C communications. See <a href="#">Section 5.1.2 "Sleep State Operation"</a> .  |
| <b>Error</b>  | This power state is entered when a fault condition exists. Error power state is one or both channels in Fault Handling. This state is updated as Priority One. The Interrupt Status Registers for each channel will update the fault detected per channel. Only the channel that has detected a Fault will be affected since the other channel can remain active if no fault is detected. See <a href="#">Section 5.1.4 "Error State Operation"</a> . |
| <b>Active</b> | Active power State is one, or both channels active and sourcing current to the $V_{BUS}$ Port. This state is updated as Priority Two. None of the channels have detected Fault. This power state provides full functionality. While in this state, operations include activation of the port power switch, current limiting, and charge rationing. See <a href="#">Section 5.1.3 "Active State Operation"</a> .                                       |

[Table 5-2](#) shows the settings for the various power states, except Off and Error. If  $V_{DD} < V_{DD\_TH}$ , the UCS2113 is in the Off state.

**TABLE 5-2: POWER STATES CONTROL SETTINGS**

| Power State | PWR_EN1  | PWR_EN2  | Behavior   |
|-------------|----------|----------|--|
| Sleep       | disabled | disabled | <ul style="list-style-type: none"> <li>All switches disabled</li> <li><math>V_{BUS}</math> will be near ground potential</li> <li>The UCS2113 wakes to respond to SMBus communications</li> </ul>      |
| Active      | enabled  | disabled | <ul style="list-style-type: none"> <li>Port power switch is on for <math>V_{BUS1}</math></li> <li><math>V_{BUS2}</math> pins are near ground potential or floating (<a href="#">Note 1</a>)</li> </ul> |
|             | disabled | enabled  | <ul style="list-style-type: none"> <li>Port power switch is on for <math>V_{BUS2}</math></li> <li><math>V_{BUS1}</math> pins are near ground potential or floating (<a href="#">Note 1</a>)</li> </ul> |
|             | enabled  | enabled  | <ul style="list-style-type: none"> <li>Port power switch is on for <math>V_{BUS1}</math> and <math>V_{BUS2}</math></li> </ul>  |

**Note 1:** If the bit EN\_VBUS\_DISCHG is '1', the  $V_{BUS}$  is discharged automatically and  $V_{BUS}$  is near ground potential. If the bit EN\_VBUS\_DISCHG is '0' then the corresponding VBUS pins are floating ( $V_{BUS}$  discharge is controlled by the SMBus host).

### 5.1.1 OFF STATE OPERATION

The device will be in the Off state if  $V_{DD}$  is less than  $V_{DD\_TH}$ . When the UCS2113 is in the Off state, it will do nothing and all circuitry will be disabled. Digital register values are not stored and the device will not respond to SMBus commands.

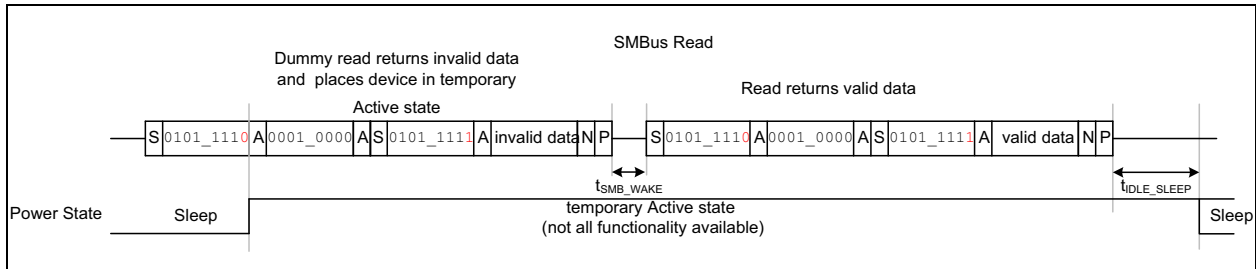
### 5.1.2 SLEEP STATE OPERATION

The PWR\_EN1 and PWR\_EN2 pins may be used to cause the UCS2113 to enter/exit Sleep. These pins are AND'ed for Sleep mode.

When the UCS2113 is in the Sleep state, the device will be in its lowest power state. The port power switch will be disabled.  $V_{BUS1}$  and  $V_{BUS2}$  will be near ground

potential. The ALERT#1 and ALERT#2 pins will not be asserted. If asserted prior to entering the Sleep state, the ALERT# pin will be released. SMBus activity is limited to single byte read or write.

The first data byte read from the UCS2113 when it is in the Sleep state will wake it; however, the data to be read will return all 0's and should be considered invalid. This is a "dummy" read byte meant to wake the UCS2113. Subsequent read or write bytes will be accepted normally. After the dummy read, the UCS2113 will be in a higher power state (see [Figure 5-2](#)). After communication has not occurred for  $t_{IDLE\_SLEEP}$ , the UCS2113 will return to Sleep.



**FIGURE 5-2:** Wake from Sleep using SMBus Read.

### 5.1.3 ACTIVE STATE OPERATION

Every time the UCS2113 enters the Active state, the port power switches are closed. The UCS2113 cannot be in the Active state (and therefore, the port power switch cannot be turned on) if any of the following conditions exist:

- $V_S < V_{S\_UVLO}$
- PWR\_EN1 and PWR\_EN2 are disabled.

### 5.1.4 ERROR STATE OPERATION

The UCS2113 will enter the Error state from the Active state when any of the following events are detected:

- The maximum allowable internal die temperature ( $T_{TSD\_HIGH}$ ) has been exceeded.
- The  $T_{TSD\_LOW}$  die temperature has been exceeded and any of the following conditions is met:
  - a power switch operates in constant current mode
  - PWR\_EN1 and/or PWR\_EN2 controls transition from inactive to active.
  - it is a power up situation and PWR\_EN1 and/or PWR\_EN2 pins are active.
- An overcurrent condition has been detected.
- An undervoltage condition on either  $V_{BUS}$  pin has been detected (see [Section 5.3.4 “Undervoltage Lockout on VS”](#)).
- A back-voltage condition has been detected (see [Section 5.3.2 “Back-voltage Detection”](#)).
- A discharge error has been detected.
- An overvoltage condition on the  $V_S$  pin.

When the UCS2113 enters the Error state, the port power switch will be disabled while the ALERT# pin is asserted. It will remain off while in this power state. The UCS2113 will leave this state as determined by the fault handling selection.

With the Auto-recovery fault handler, after the  $t_{CYCLE}$  time period, the UCS2113 will check that all of the error conditions have been removed.

If all of the error conditions have been removed, the UCS2113 will return to the Active state.

If both PWR\_EN1 and PWR\_EN2 controls transition from active to inactive while the UCS2113 is in the Error state, the device will not enter the Sleep state. After the fault has been removed, the UCS2113 will not automatically enter the Sleep state if the EN\_VBUS\_DISCHG bit from the General Configuration 2 Register is not set (default setting). To enter the Sleep state, the PWR\_EN pins must be toggled or an SMBus read register command must be sent.

## 5.2 Communication

The UCS2113 can operate in SMBus mode (see [Section 7.0 “System Management Bus Protocol”](#)) or Stand-Alone mode. The resistor connected to the COMM\_ILIM pin determines the operating mode and the hardware-set  $I_{LIM}$  setting, as shown in [Table 5-3](#). Unless connected to GND or  $V_{DD}$ , the resistors in [Table 5-3](#) are external pull-down resistors.

The SMBus address is specified in [Section 7.2 “SMBus Address and RD/WR Bit”](#).

**TABLE 5-3: COMMUNICATION DECODE**

| COMM_ILIM Pull Down Resistor ( $\pm 1\%$ ) | PWR_EN1 and PWR_EN2 Polarity | $I_{LIM}$ (A) | Total $I_{LIM}$ (A) (Note 1) | Communication Mode |
|--|------------------------------|---------------|------------------------------|--------------------|
| GND  | Active-High                  | 0.53          | 0.53 + 0.53                  | SMBUS              |
| 10 k $\Omega$                              | Active-High                  | 0.96          | 0.96 + 0.96                  | SMBUS              |
| 12 k $\Omega$                              | Active-High                  | 1.07          | 1.07 + 1.07                  | SMBUS              |
| 15 k $\Omega$                              | Active-High                  | 1.28          | 1.28 + 1.28                  | SMBUS              |
| 18 k $\Omega$                              | Active-High                  | 1.6           | 1.6 + 1.6                    | SMBUS              |

**TABLE 5-3: COMMUNICATION DECODE (CONTINUED)**

| COMM_ILIM Pull Down Resistor ( $\pm 1\%$ ) | PWR_EN1 and PWR_EN2 Polarity | $I_{LIM}$ (A) | Total $I_{LIM}$ (A) (Note 1) | Communication Mode |
|--|------------------------------|---------------|------------------------------|--------------------|
| 22 k $\Omega$                              | Active-High                  | 2.13          | 2.13 + 2.13                  | SMBUS              |
| 27 k $\Omega$                              | Active-High                  | 2.67          | 2.67 + 2.67                  | SMBUS              |
| 33 k $\Omega$                              | Active-High                  | 3.2           | 3.2 + 3.2                    | SMBUS              |
| 47 k $\Omega$                              | Active-Low                   | 0.53          | 0.53 + 0.53                  | Stand-Alone        |
| 56 k $\Omega$                              | Active-Low                   | 0.96          | 0.96 + 0.96                  | Stand-Alone        |
| 68 k $\Omega$                              | Active-Low                   | 1.07          | 1.07 + 1.07                  | Stand-Alone        |
| 82 k $\Omega$                              | Active-Low                   | 1.28          | 1.28 + 1.28                  | Stand-Alone        |
| 100 k $\Omega$                             | Active-Low                   | 1.6           | 1.6 + 1.6                    | Stand-Alone        |
| 120 k $\Omega$                             | Active-Low                   | 2.13          | 2.13 + 2.13                  | Stand-Alone        |
| 150 k $\Omega$                             | Active-Low                   | 2.67          | 2.67 + 2.67                  | Stand-Alone        |
| $V_{DD}$                                   | Active-Low                   | 3.2           | 3.2 + 3.2                    | Stand-Alone        |

**Note 1:** The total maximum current depends on power dissipation characteristics of the design (see [Table 1-1](#)).

## 5.3 Supply Voltages

### 5.3.1 $V_{DD}$ SUPPLY VOLTAGE

The UCS2113 requires 4.5V to 5.5V to be present on the  $V_{DD}$  pin for core device functionality. Core device functionality consists of maintaining register states and wake-up upon SMBus/I<sup>2</sup>C query.

### 5.3.2 BACK-VOLTAGE DETECTION

The back-voltage detector is functional in all power states (Sleep and Active).

When in Sleep, the UCS2113 will enter the Error state from Sleep if a back-voltage condition was detected.

Whenever the following condition is true for either port, the port power switch will be disabled and a back-voltage event will be flagged. This will cause the UCS2113 to enter the Error power state (see [Section 5.1.4 “Error State Operation”](#)).

**Note:** The  $V_{BUS}$  voltage exceeds the  $V_S$  and/or the  $V_{DD}$  pin voltage by  $V_{BV\_TH}$  and the port power switch is closed. The port power switch will be opened immediately. If the condition lasts for longer than  $t_{MASK}$ , then the UCS2113 will enter the Error state. Otherwise, the port power switch will be turned on as soon as the condition is removed.

### 5.3.3 BACK-DRIVE CURRENT PROTECTION

If a portable device is attached that is self-powered, it may drive the  $V_{BUS}$  port to its power supply voltage level; however, the UCS2113 is designed such that leakage current from the  $V_{BUS}$  pins to the  $V_{DD}$  and/or the  $V_S$  pin shall not exceed  $I_{LKG\_1}$  (if the  $V_{DD}$  and/or  $V_S$  voltage is zero) or  $I_{LKG\_2}$  (if the  $V_{DD}$  and/or  $V_S$  voltage exceeds  $V_{DD\_TH}$  and the power switch is open).

### 5.3.4 UNDERVOLTAGE LOCKOUT ON $V_S$

The UCS2113 requires a minimum voltage ( $V_{S\_UVLO}$ ) be present on the  $V_S$  pin for Active power state.

### 5.3.5 OVERVOLTAGE DETECTION AND LOCKOUT ON $V_S$

Both power switches will be disabled if the voltage on any  $V_S$  pin exceeds a voltage ( $V_{S\_OV}$ ) for longer than the specified time ( $t_{MASK}$ ). This will cause the device to enter the Error state and both ALERT#1 and ALERT#2 pins will be asserted.

### 5.3.6 PWR\_EN1 AND PWR\_EN2 INPUT

The PWR\_EN control affects the power state and enables the port power switch to be turned on if conditions are met (see [Table 5-2](#)). The port power switch cannot be closed if PWR\_EN is disabled. However, if PWR\_EN is enabled, the port power switch is not necessarily closed (see [Section 5.1.3 “Active State Operation”](#)). In SMBus mode, the PWR\_EN1 and PWR\_EN2 pins states will be ignored by the UCS2113 if the PIN\_IGN configuration bit is set; otherwise, the PWR\_EN1S and PWR\_EN2S configuration bits are checked along with the pins.

## 5.4 Discrete Output Pins

### 5.4.1 ALERT#1 AND ALERT#2 OUTPUT PINS

The UCS2113 has two independent ALERT# out pins. ALERT#1 is tied to the status of the V<sub>BUS1</sub> pin. ALERT#2 is tied to the status of the V<sub>BUS2</sub> pin.

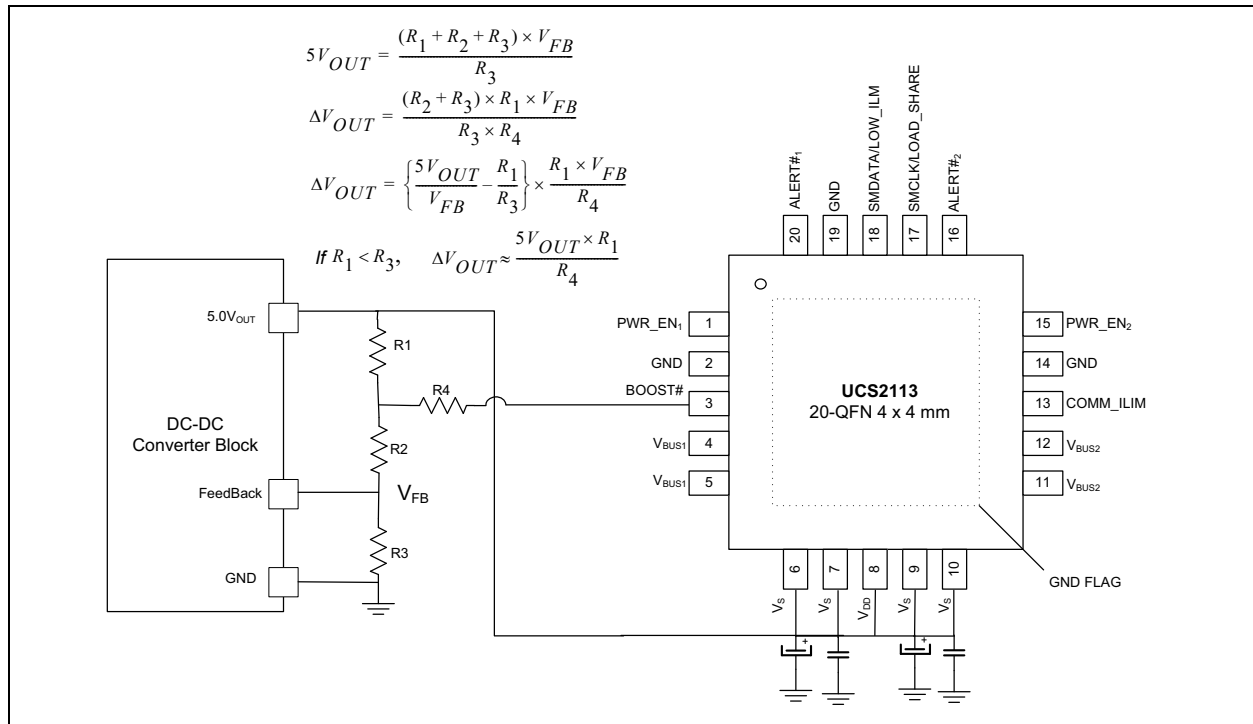
The ALERT# pin is an active-low open-drain interrupt to the host controller. The ALERT# pin is asserted when an error occurs. Also, when charge rationing is enabled, the ALERT# pin is asserted by default when the current rationing threshold is reached (as determined by RATION\_BEH<1:0>). The ALERT# pin is released when all error conditions that may assert the ALERT# pin (such as an error condition and charge rationing) have been removed or reset as necessary.

The UCS2113 is compatible with the Microchip hub devices supporting single pin power control feature. These hub devices have a single connection to the PWR\_EN and ALERT# pins of the UCS2113, which are tied together in the application.

### 5.4.2 BOOST# OUTPUT PIN

The UCS2113 provides a BOOST# output pin to compensate for voltage drops during high loads. The BOOST# pin is an active-low, open-drain output that would be connected to a resistor in the DC-DC converter's feedback error voltage loop (see [Figure 5-3](#)).

The BOOST# pin is asserted when V<sub>BUS</sub> Current > I<sub>BOOST</sub>. I<sub>BOOST</sub> typical value is 1.9A. The BOOST# is OR'ed for both V<sub>BUS1</sub> and V<sub>BUS2</sub> ports. When the BOOST# pin is asserted, it will remain in this state for at least t<sub>BOOST\_MAT</sub> (minimum assertion time).



**FIGURE 5-3:** Boost# Pin Usage.

## 5.5 Discrete Input Pins

### 5.5.1 COMM\_ILIM INPUT

The COMM\_ILIM input determines the communications mode, as shown in [Table 6-1](#). This is also the hardware strap for MAX Current Limit.

### 5.5.2 SMCLK

When operated in Stand-Alone mode, this pin should be tied to ground. When the UCS2113 is configured for SMBus communications, the SMCLK is the clock input.

### 5.5.3 SMDATA

When used in Stand-Alone, this pin should be tied to ground.

When the UCS2113 is configured for SMBus communications, the SMDATA is the data input/output.

## 6.0 USB PORT POWER SWITCH

To assure compliance to various charging specifications, the UCS2113 contains a USB port power switch that supports two current-limiting modes: Trip and Constant current (variable slope). The current limit ( $I_{LIM}$ ) is pin selectable (and may be updated via the register set). The switch also includes soft start circuitry and a separate short circuit current limit.

The port power switch is on in the Active state (except when  $V_{BUS}$  is discharging).

### 6.1 Current Limiting

#### 6.1.1 CURRENT LIMIT SETTING

The UCS2113 hardware set current limit,  $I_{LIM}$ , can be one of eight values. This resistor value is read once upon UCS2113 power-up. The current limit can be changed via the SMBus/I<sup>2</sup>C after power-up; however, the programmed current limit cannot exceed the hardware set current limit. Unless connected to  $V_{DD}$ , the resistors in [Table 6-1](#) are pull-down resistors.

At power-up, the communication mode (Stand-Alone or SMBus/I<sup>2</sup>C) and hardware current limit ( $I_{LIM}$ ) are determined via the pull-down resistor (or pull-up resistor if connected to  $V_{DD}$ ) on the COMM\_ILIM pin, as shown in [Table 6-1](#).

#### 6.1.2 SHORT CIRCUIT OUTPUT CURRENT LIMITING

Short circuit current limiting occurs when the output current is above the selectable current limit ( $I_{LIMx}$ ). This event will be detected and the current will immediately be limited (within  $t_{SHORT\_LIM}$  time). If the condition remains, the port power switch will flag an Error condition and enter the Error state.

#### 6.1.3 SOFT START

When the PWR\_EN control changes states to enable the port power switch, the UCS2113 invokes a soft start routine for the duration of the  $V_{BUS}$  rise time ( $t_{R\_BUS}$ ). This soft start routine will limit current flow from  $V_S$  into  $V_{BUS}$  while it is active. This circuitry will prevent current spikes due to a step in the portable device current draw.

In the case when a portable device is attached while the PWR\_EN pin is already enabled, if the bus current exceeds  $I_{LIM}$ , the UCS2113 current limiter will respond within a specified time ( $t_{SHORT\_LIM}$ ) and will operate normally at this point. The  $C_{BUS}$  capacitor will deliver the extra current, if any, as required by the load change.

TABLE 6-1:  $I_{LIM}$  DECODE

| COMM_ILIM Pulldown Resistor ( $\pm 1\%$ ) | PWR_EN1 and PWR_EN2 Polarity | $I_{LIM}$ (A) | Total $I_{LIM}$ (A) (Note 1) |
|---|------------------------------|---------------|------------------------------|
| GND                                       | Active-High                  | 0.53          | 0.53+0.53                    |
| 10 k $\Omega$                             | Active-High                  | 0.96          | 0.96+0.96                    |
| 12 k $\Omega$                             | Active-High                  | 1.07          | 1.07+1.07                    |
| 15 k $\Omega$                             | Active-High                  | 1.28          | 1.28+1.28                    |
| 18 k $\Omega$                             | Active-High                  | 1.6           | 1.6+1.6                      |
| 22 k $\Omega$                             | Active-High                  | 2.13          | 2.13+2.13                    |
| 27 k $\Omega$                             | Active-High                  | 2.67          | 2.67+2.67                    |
| 33 k $\Omega$                             | Active-High                  | 3.2           | 3.2+3.2                      |
| 47 k $\Omega$                             | Active-Low                   | 0.53          | 0.53+0.53                    |
| 56 k $\Omega$                             | Active-Low                   | 0.96          | 0.96+0.96                    |
| 68 k $\Omega$                             | Active-Low                   | 1.07          | 1.07+1.07                    |
| 82 k $\Omega$                             | Active-Low                   | 1.28          | 1.28+1.28                    |
| 100 k $\Omega$                            | Active-Low                   | 1.6           | 1.6+1.6                      |
| 120 k $\Omega$                            | Active-Low                   | 2.13          | 2.13+2.13                    |
| 150 k $\Omega$                            | Active-Low                   | 2.67          | 2.67+2.67                    |
| $V_{DD}$                                  | Active-Low                   | 3.2           | 3.2+3.2                      |

**Note 1:** The total maximum current depends on power dissipation characteristics of the design (see [Table 1-1](#)).

#### 6.1.4 CURRENT LIMITING MODES

The UCS2113 current limiting has two modes: Trip and Constant Current (variable slope). Either mode functions at all times when the port power switch is closed.

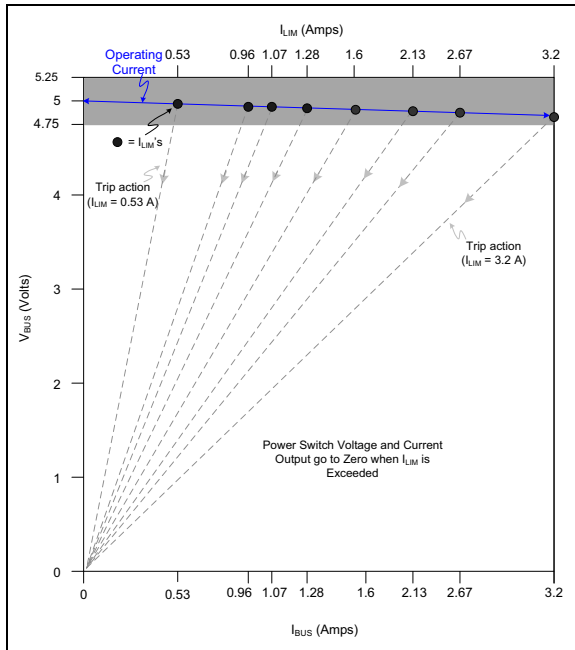
##### 6.1.4.1 Trip Mode

When using Trip current limiting, the UCS2113 USB port power switch functions as a low-resistance switch and rapidly turns off if the current limit is exceeded. While operating using Trip current limiting, the  $V_{BUS}$  output voltage will be held relatively constant (equal to the  $V_S$  voltage minus the  $R_{ON} \times I_{BUS}$  current) for all current values up to the  $I_{LIM}$ .

If the current drawn by a portable device exceeds  $I_{LIM}$ , the following occurs:

1. The port power switch will be turned off (Trip action).
2. The UCS2113 will enter the Error state and assert the ALERT# pin.
3. The fault handling circuitry will then determine subsequent actions.

Figure 6-1 shows operation of current limits in Trip mode with the shaded area representing the USB 2.0 specified  $V_{BUS}$  range. Dashed lines indicate the port power switch output will go to zero (e.g., Trip) when  $I_{LIM}$  is exceeded. Note that operation at all possible values of  $I_{LIM}$  are shown in Figure 6-1 for illustrative purposes only; in actual operation only one  $I_{LIM}$  can be active at any time.

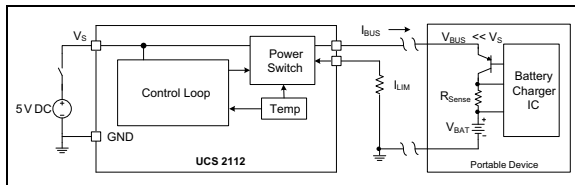


**FIGURE 6-1:** Current Limiting in Trip Mode.

### 6.1.4.2 Constant Current Limiting (Variable Slope)

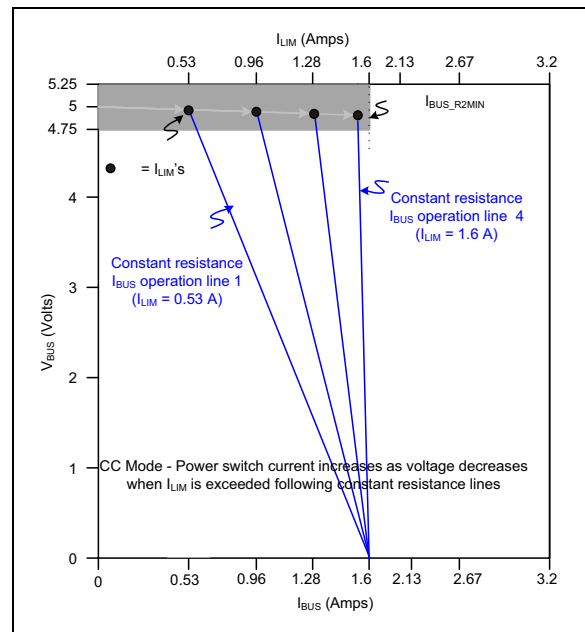
Constant current limiting is used when the current drawn is greater than  $I_{LIM}$  (and  $I_{LIM} \leq 1.6A$ ). In CC mode, the port power switch allows the attached portable device to reduce  $V_{BUS}$  output voltage to less than the input  $V_S$  voltage while maintaining current delivery. The  $V/I$  slope depends on the user set  $I_{LIM}$  value. This slope is held constant for a given  $I_{LIM}$  value.

This mode is specifically provided for devices that rely on resistive means to reduce  $V_{BUS}$  voltage for direct battery charging or to allow portable devices a means to “test” charger capacity. See Figure 6-2.



**FIGURE 6-2:** Constant Current Example.

Figure 6-3 shows operation of current limits while using CC mode. Unlike Trip mode, once  $I_{BUS}$  current exceeds  $I_{LIM}$ , operation continues at a reduced voltage and increased current. Note that the shaded area representing the USB 2.0 specified  $V_{BUS}$  range is now restricted to an upper current limit of  $I_{BUS\_R2MIN}$ . Note that the UCS2113 will heat up along each load line as voltage decreases. If the internal temperature exceeds the  $T_{TSD\_LOW}$  threshold, the corresponding power switch operating in constant current mode will open. If the internal temperature exceeds the  $T_{TSD\_HIGH}$  threshold, both power switches will open, regardless of whether the power switch channels are in current limit. Also note that when the  $V_{BUS}$  voltage is brought low enough (below  $V_{BUS\_MIN}$ ), the port power switch will open.



**FIGURE 6-3:** Current Limiting in CC Mode.

## 6.2 USB Port Power Profiles

The UCS2113 combines the qualities of traditional USB port power switches with USB port power profiles set forth in the USB-IF BC1.2 specification. USB port power profiles consist of distinct voltage-current operation regions defined by “keep-out” and “operation” regions.

While operating in the CC mode of operation, the UCS2113 provides voltage-current output operating profiles that are specified by two keep-out regions.

If the current reaches the  $I_{BUS\_R2MIN}$  setting for longer than  $t_{MASK}$ , the UCS2113 enters the Error state and an Overcurrent event is flagged.

If the  $V_{BUS}$  voltage ever goes below the no operation lower-voltage keep-out ( $V_{BUS\_MIN}$ ) value for longer than  $t_{MASK}$ , the port power switch is disabled and a

keep-out violation is flagged (by setting the MIN\_KEEP\_OUT status bit). This will cause the device to enter the Error state.

Figure 6-4 illustrates the relationship between these USB port power profile parameters.

## 6.2.1 OPERATION WITHIN A USB PORT POWER PROFILE

An attached device may be constrained to operate within the boundaries of a USB port power profile by setting the value of  $I_{LIM}$  less than the USB port power profile  $I_{BUS\_R2MIN}$  value. In this case, the port power switch will be in Trip mode up until  $I_{LIM}$  is exceeded. At which point, the switch will transition into CC mode. If the attached device reduces the output voltage to less than  $V_{BUS\_MIN}$ , the switch will trip and terminate charging.

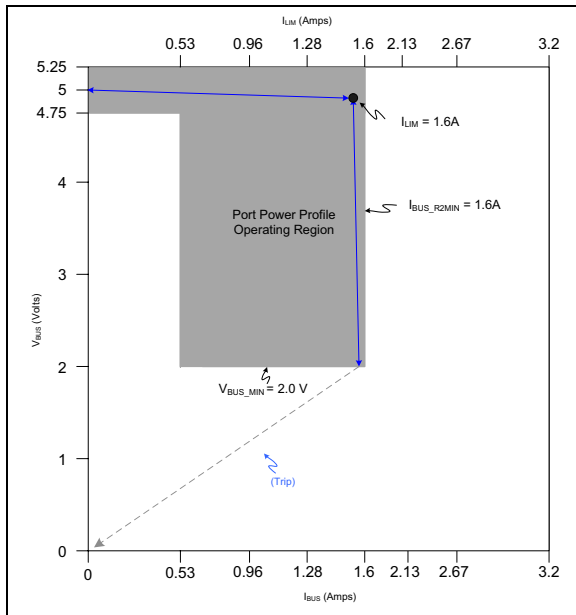


FIGURE 6-4:  $I_{LIM} < I_{BUS\_R2MIN}$  Example.

**Note:** The CC mode of operation is possible only up to 1.6A. As long as the value of  $I_{LIM}$  is less than the fixed port power profile  $I_{BUS\_R2MIN}$  value, CC mode is possible. Otherwise, the USB port power switch will operate in Trip mode operation.

## 6.2.2 OPERATION OUTSIDE OF A USB PORT POWER PROFILE

An attached device may be allowed to operate outside of the boundaries of a USB port power profile by setting the value of  $I_{LIM}$  greater than the USB port power profile  $I_{BUS\_R2MIN}$  value. This is the default operation for all portable devices. In this case, the USB port power switch will operate in Trip mode until the bus current reaches the  $I_{LIM}$  value. Once the  $I_{LIM}$  value has been exceeded, the port power switch will open and terminate charging. Figure 6-5 illustrates an example of current limiting in this configuration.

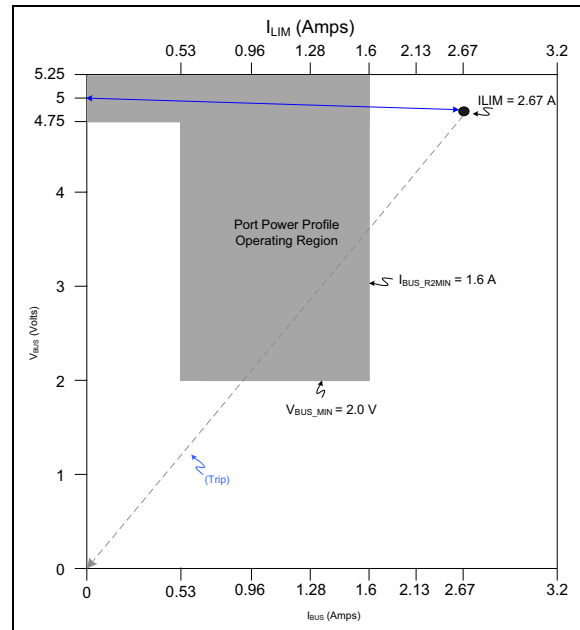


FIGURE 6-5:  $I_{LIM} > I_{BUS\_R2MIN}$  Example.



## 6.3 Thermal Protection

The UCS2113 utilizes two-stage internal thermal management. The first is triggered when the die temperature exceeds  $T_{TSD\_LOW}$  threshold and the second is triggered when the die temperature exceeds  $T_{TSD\_HIGH}$  threshold.

### 6.3.0.1 THE FIRST THERMAL SHUTDOWN STAGE ( $T_{TSD\_LOW}$ )

The first stage turns off the individual power switch channel when the die temperature exceeds  $T_{TSD\_LOW}$  threshold and a power switch operates in constant current mode. It also causes the corresponding channel to enter in error state and the corresponding ALERT# pin will be asserted.

When an over-current condition appears, the power switch operates in constant current mode for the duration of  $t_{MASK}$  time. Because of the increased voltage drop across the switch, the die temperature increases. If the die temperature exceeds  $T_{TSD\_LOW}$  threshold before the expiration of the  $t_{MASK}$  time, then the power switch will open immediately.

If the  $T_{TSD\_LOW}$  threshold has been exceeded, but the die temperature has not decreased below the  $T_{TSD\_LOW}$  recovery threshold, then the power switch cannot be closed when commanded by the PWR\_EN1 or PWR\_EN2 controls in the following situations:

- PWR\_EN1 and/or PWR\_EN2 controls transition from inactive to active.
- it is a power up situation and PWR\_EN1 and/or PWR\_EN2 pins are active.

In these situations, the corresponding channel will enter in error state and the corresponding ALERT# pin will be asserted.

The first thermal shutdown stage allows the two ports to work independently, by preventing the die temperature to increase during over-current conditions and to exceed the maximum allowable temperature ( $T_{TSD\_HIGH}$ ).

The error state will persist and the power switches can not be closed until the temperature is below  $T_{TSD\_LOW} - T_{TSD\_LOW\_HYST}$ .

### 6.3.0.2 THE SECOND THERMAL SHUTDOWN STAGE ( $T_{TSD\_HIGH}$ )

The second thermal protection stage turns off both power switches when the die temperature exceeds  $T_{TSD\_HIGH}$  threshold, regardless of whether the power switch channels are in current limit. It also causes both channels to enter in error state and both ALERT#1 and ALERT#2 pins to be asserted.

The error state will persist and the power switches cannot be closed until the temperature is below  $T_{TSD\_HIGH} - T_{TSD\_HIGH\_HYST}$ .

## 6.4 $V_{BUS}$ Discharge

When the EN\_VBUS\_DISCHG bit from General Configuration 2 Register is set (by default it is not set), the UCS2113 will discharge  $V_{BUS}$  through an internal  $100\Omega$  resistor when at least one of the following conditions occur:

- The PWR\_EN control is disabled (triggered on the inactive edge of the PWR\_EN control).
- The  $V_S$  voltage drops below a specified threshold ( $V_{S\_UVLO}$ ) that causes the port power switch to be disabled.
- When commanded into the Sleep power state.
- Upon recovery from the Error state.
- When commanded via the SMBus in the Active state.

When the automatic  $V_{BUS}$  discharge circuitry is activated, the UCS2113 will confirm that  $V_{BUS}$  was discharged at the end of the  $t_{DISCHARGE}$  time. If the  $V_{BUS}$  voltage is not below the  $V_{TEST}$  level, a discharge error will be flagged (by setting the DISCH\_ERR(1/2) status bit) and the UCS2113 will enter the Error state.

When the EN\_VBUS\_DISCHG bit from General Configuration 2 Register is not set (default setting), the automatic  $V_{BUS}$  discharges described above are disabled. In this case, the SMBus host must set and clear bits DISCHG\_LOAD1 and DISCHG\_LOAD2 from the Current Limit Behavior Registers, to discharge the  $V_{BUS1}$  and  $V_{BUS2}$ . Setting the DISCHG\_LOAD1 and DISCHG\_LOAD2 bits connects the internal  $100\Omega$  resistor to discharge the corresponding  $V_{BUS}$  path. This functionality doesn't use any timers. The discharge time is controlled by the SMBus host, which must clear this bit when its internal timer expires.

# UCS2113

## 6.5 Charge Rationing Interactions

When charge rationing is active, regardless of the specified behavior, the UCS2113 will function normally until the charge rationing threshold is reached. Note that charge rationing is only active when the UCS2113 is in the Active state. Changing the charge rationing behavior will have no effect on the charge rationing data registers. If the behavior is changed prior to reaching the charge rationing threshold, this change

will occur and be transparent to the user. When the charge rationing threshold is reached, the UCS2113 will take action as shown in [Table 6-2](#). If the behavior is changed after the charge rationing threshold has been reached, the UCS2113 will immediately adopt the newly programmed behavior, clearing the ALERT# pin and restoring switch operation respectively (see [Table 6-4](#)).

**TABLE 6-2: CHARGE RATIONING BEHAVIOR**

| RATION_BEH<br>(1 or 2) <1:0> |   | Behavior                        | Actions Taken   | Notes  |
|------------------------------|---|---------------------------------|---|--|
| 1                            | 0 |                                 |   |  |
| 0                            | 0 | Report                          | ALERT# pin asserted.  |  |
| 0                            | 1 | Report and Disconnect (default) | <ol style="list-style-type: none"> <li>ALERT# pin asserted</li> <li>Port power switch disconnected</li> </ol>               | All bus monitoring is still active. Toggling the PWR_EN control will cause the device to change power states as defined by the registers; however, the port power switch will remain off until the rationing circuitry is reset. |
| 1                            | 0 | Disconnect and Go to Sleep      | <ol style="list-style-type: none"> <li>Port power switch disconnected</li> <li>Device will enter the Sleep state</li> </ol> | All V <sub>BUS</sub> and V <sub>S</sub> monitoring will be stopped. Toggling the PWR_EN control will have no effect on the power state until the rationing circuitry is reset.   |
| 1                            | 1 | Ignore                          | Take no further action  |  |

**TABLE 6-3: CHARGE RATIONING RESET BEHAVIOR**

| Behavior                   | Reset Actions  |
|----------------------------|--|
| Report                     | <ol style="list-style-type: none"> <li>Reset the Total Accumulated Charge registers</li> <li>Clear the RATION status bit</li> <li>Release the ALERT# pin</li> </ol>  |
| Report and Disconnect      | <ol style="list-style-type: none"> <li>Reset the Total Accumulated Charge registers</li> <li>Clear the RATION status bit</li> <li>Release the ALERT# pin</li> <li>Check the PWR_EN controls and enter the indicated power state if the controls changed</li> </ol> |
| Disconnect and Go to Sleep | <ol style="list-style-type: none"> <li>Reset the Total Accumulated Charge registers</li> <li>Clear the RATION status bit</li> <li>Check the PWR_EN controls and enter the indicated power state if the controls changed</li> </ol>                                 |
| Ignore                     | <ol style="list-style-type: none"> <li>Reset the Total Accumulated Charge registers</li> <li>Clear the RATION status bit</li> </ol>  |

**TABLE 6-4: EFFECTS OF CHANGING RATIONING BEHAVIOR AFTER THRESHOLD REACHED**

| Previous Behavior | New Behavior               | Actions Taken   |
|-------------------|----------------------------|---|
| Ignore            | Report                     | Assert ALERT# pin   |
|                   | Report and Disconnect      | <ol style="list-style-type: none"> <li>Assert ALERT# pin</li> <li>Open port power switch. See the <a href="#">Report and Disconnect (default)</a> in <a href="#">Table 6-2</a></li> </ol> |
|                   | Disconnect and Go to Sleep | <ol style="list-style-type: none"> <li>Open port power switch</li> <li>Enter the Sleep state. See the <a href="#">Disconnect and Go to Sleep</a> in <a href="#">Table 6-2</a></li> </ol>  |

**TABLE 6-4: EFFECTS OF CHANGING RATIONING BEHAVIOR AFTER THRESHOLD REACHED**

| Previous Behavior          | New Behavior               | Actions Taken  |
|----------------------------|----------------------------|--|
| Report                     | Ignore                     | Release ALERT# pin.  |
|                            | Report and Disconnect      | Open port power switch. See the <a href="#">Report and Disconnect (default)</a> in <a href="#">Table 6-2</a> .   |
|                            | Disconnect and Go to Sleep | <ol style="list-style-type: none"> <li>1. Release the ALERT# pin</li> <li>2. Open the port power switch</li> <li>3. Enter the Sleep state. See the <a href="#">Disconnect and Go to Sleep</a> in <a href="#">Table 6-2</a>.</li> </ol> |
| Report and Disconnect      | Ignore                     | <ol style="list-style-type: none"> <li>1. Release the ALERT# pin</li> <li>2. Check the PWR_EN controls and enter the indicated power state if the controls changed</li> </ol>  |
|                            | Report                     | Check the PWR_EN controls and enter the indicated power state if the controls changed  |
|                            | Disconnect and Go to Sleep | <ol style="list-style-type: none"> <li>1. Release the ALERT# pin</li> <li>2. Enter the Sleep state. See the <a href="#">Disconnect and Go to Sleep</a> in <a href="#">Table 6-2</a>.</li> </ol>  |
| Disconnect and Go to Sleep | Ignore                     | Check the PWR_EN controls and enter the indicated power state if the controls changed  |
|                            | Report                     | <ol style="list-style-type: none"> <li>1. Assert the ALERT# pin</li> <li>2. Check the PWR_EN controls and enter the indicated power state if the controls changed</li> </ol>   |
|                            | Report and Disconnect      | <ol style="list-style-type: none"> <li>1. Assert the ALERT# pin</li> <li>2. Check the PWR_EN controls to determine the power state, then enter that state, except that the port power switch will not be closed</li> </ol>             |

If the RATION\_EN control is set to '0' prior to reaching the charge rationing threshold, rationing will be disabled and the Total Accumulated Charge registers will be cleared. If the RATION\_EN control is set to '0' after the charge rationing threshold has been reached, the following additional steps occur:

1. RATION status bit will be cleared.
2. The ALERT# pin will be released if asserted by the rationing circuitry and no other conditions are present.
3. The PWR\_EN controls are checked to determine the power state.

Setting the RATION\_RST control to '1' will automatically reset the Total Accumulated Charge registers to 00\_00h. If this is done prior to reaching the charge rationing threshold, the data will continue to be accumulated restarting from 00\_00h. If this is done after the charge rationing threshold is reached, the UCS2113 will take action as shown in [Table 6-3](#).

## 6.6 Fault Handling Mechanism

The UCS2113 has two modes for handling faults:

- Latch (latch-upon-fault)
- Auto-recovery (automatically attempt to restore the Active power state after a fault occurs).

If the SMBus is actively utilized, Auto-Recovery Fault Handling is the default error handler as determined by the LATCH\_SET bit. Faults include overcurrent, overvoltage (on  $V_S$ ), undervoltage (on  $V_{BUS}$ ), back-voltage ( $V_{BUS}$  to  $V_S$  or  $V_{BUS}$  to  $V_{DD}$ ), discharge error, and maximum allowable internal die temperature ( $T_{TSD\_HIGH}$ ) exceeded. Fault conditions also include the situations when  $T_{TSD\_LOW}$  die temperature has been exceeded and any of the following conditions are met:

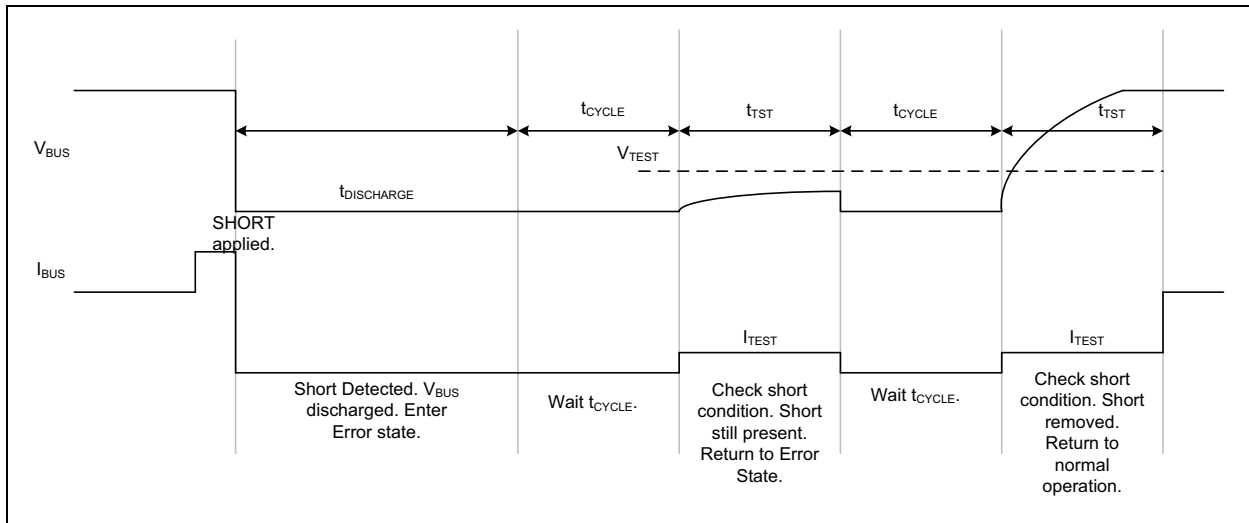
- a power switch operates in constant current mode
- PWR\_EN1 and/or PWR\_EN2 controls transition from inactive to active.
- it is a power up situation and PWR\_EN1 and/or PWR\_EN2 pins are active.

Faults do not include:

- keep-out violations except  $V_{BUS\_MIN}$ .
- $T_{TSD\_LOW}$  die temperature has been exceeded and any of the following conditions are met:
  - the power switch is closed at the time when  $T_{TSD\_LOW}$  is reached and it is not in constant current mode.
  - the power switch remains open (PWR\_EN1 and/or PWR\_EN2 controls are not active).

### 6.6.1 AUTO-RECOVERY FAULT HANDLING

When the LATCH\_SET bit is low, Auto-Recovery Fault Handling is used. When an error condition is detected, the UCS2113 will immediately enter the Error state and assert the ALERT# pin. Independently from the host controller, the UCS2113 will wait a preset time ( $t_{CYCLE}$ ), check error conditions ( $t_{TST}$ ), and restore Active operation if the error condition(s) no longer exist. If all other conditions that may cause the ALERT# pin to be asserted have been removed, the ALERT# pin will be released. Short-Circuit Auto-Recovery example in [Figure 6-6](#).



**FIGURE 6-6:** Error Recovery.

### 6.6.2 LATCHED FAULT HANDLING

When the LATCH\_SET bit is high, latch fault handling is used. When an error condition is detected, the UCS2113 will enter the Error power state and assert the ALERT# (1 or 2) pin. Upon command from the host controller (by toggling the PWR\_EN (1, or 2) pin control from enabled to disabled or by clearing the ERR bit via SMBus), the UCS2113 will check error conditions once and restore Active operation if error conditions no longer exist. If an error condition still exists, the host controller is required to issue the command again to check error conditions.

If the ALERT# pin is asserted and the interrupt status registers (addresses 03h or 04h) are not read, the corresponding ALERT# pin remains asserted until the corresponding PWR\_EN pin is toggled.

If the ALERT# pin is asserted and the interrupt status registers are read, the ALERT# pin will deassert, but the UCS will remain in error state until the ERR bit is cleared via SMBus or the PWR\_EN pin is toggled.

## 7.0 SYSTEM MANAGEMENT BUS PROTOCOL

In SMBus mode, the UCS2113 communicates with a host controller, such as a Microchip PIC<sup>®</sup> microcontroller or hub, through the SMBus. The SMBus is a two-wire serial communication protocol between a computer host and its peripheral devices. A detailed timing diagram is shown in [Figure 1-1](#). Stretching of the SMCLK signal is supported; however, the UCS2113 will not stretch the clock signal.

### 7.1 SMBus Start Bit

The SMBus Start bit is defined as a transition of the SMBus Data line from a logic '1' state to a logic '0' state while the SMBus Clock line is in a logic '1' state.

### 7.2 SMBus Address and RD/WR Bit

The SMBus Address Byte consists of the 7-bit client address followed by the RD/WR indicator bit. If this RD/WR bit is a logic '0', the SMBus Host is writing data to the client device. If this RD/WR bit is a logic '1', the SMBus Host is reading data from the client device.

The UCS2113 with the order code UCS2113-1-V/G4 has the SMBus address 57h - 1010\_111(r/w).

Customers should contact their distributor, representatives or field application engineer (FAE) for additional SMBus addresses. Local sales offices are also available to help customers. A list of sales offices and locations is included in the back of this document.

### 7.3 SMBus Data Bytes

All SMBus Data bytes are sent most significant bit first and composed of 8 bits of information.

### 7.4 SMBus ACK and NACK Bits

The SMBus client will acknowledge all data bytes that it receives. This is done by the client device pulling the SMBus Data line low after the 8th bit of each byte that is transmitted. This applies to both the Write Byte and Block Write protocols.

The Host will NACK (not acknowledge) the last data byte to be received from the client by holding the SMBus data line high after the 8th data bit has been sent. For the Block Read protocol, the Host will ACK (acknowledge) each data byte that it receives except the last data byte.

### 7.5 SMBus Stop Bit

The SMBus Stop bit is defined as a transition of the SMBus Data line from a logic '0' state to a logic '1' state while the SMBus clock line is in a logic '1' state. When the UCS2113 detects an SMBus Stop bit and it has been communicating with the SMBus protocol, it will reset its client interface and prepare to receive further communications.

### 7.6 SMBus Time-out

The UCS2113 includes an SMBus time-out feature. If the clock is held at logic '0' for  $t_{TIMEOUT}$ , the device can time out and reset the SMBus interface. The SMBus interface can also reset if both the clock and data lines are held at a logic '1' for  $t_{IDLE\_RESET}$ . Communication is restored with a start condition.

The time-out function defaults to disabled. It can be enabled by clearing the DIS\_TO bit in the General Configuration 3 register (see [Register 8-9](#)).

### 7.7 SMBus and I<sup>2</sup>C Compliance

The major difference between SMBus and I<sup>2</sup>C devices is highlighted here. For complete compliance information, refer to the SMBus 2.0 specification and Application Note 14.0.

- UCS2113 supports I<sup>2</sup>C fast mode at 400 kHz. This covers the SMBus maximum time of 100 kHz.
- The minimum frequency for SMBus communications is 10 kHz.
- The client protocol will reset if the clock is held low longer than 30 ms. This time out functionality is disabled by default in the UCS2113 and can be enabled by clearing the DIS\_TO bit. I<sup>2</sup>C does not have a time out.
- Except when operating in Sleep, the client protocol will reset if both the clock and the data line are logic '1' for longer than 200  $\mu$ s (idle condition). This function is disabled by default in the UCS2113 and can be enabled by clearing the DIS\_TO bit. I<sup>2</sup>C does not have an idle condition.
- I<sup>2</sup>C devices do not support the Alert Response Address functionality (which is optional for SMBus).
- I<sup>2</sup>C devices support block read and write differently. I<sup>2</sup>C protocol allows for unlimited number of bytes to be sent in either direction. The SMBus protocol requires that an additional data byte indicating number of bytes to read/write is transmitted. The UCS2113 supports I<sup>2</sup>C formatting only.

### 7.8 SMBus Protocols

The UCS2113 is SMBus 2.0-compatible and supports Send Byte, Read Byte, Block Read, Receive Byte as valid protocols as shown below. The UCS2113 also supports the I<sup>2</sup>C block read and block write protocols. The device supports Write Byte, Read Byte, and Block Read/Block Write. All of the below protocols use the convention in [Table 7-1](#).

**TABLE 7-1: SMBUS PROTOCOL**

| Data Sent to Device | Data Sent to the Host |
|---------------------|-----------------------|
| Data sent           | Data sent             |

# UCS2113

## 7.9 SMBus Write Byte

The Write Byte is used to write one byte of data to a specific register as shown in [Table 7-2](#).

**TABLE 7-2: WRITE BYTE PROTOCOL**

| START | Client Address | WR | ACK | Reg. Addr. | ACK | Register Data | ACK | STOP  |
|-------|----------------|----|-----|------------|-----|---------------|-----|-------|
| 1 → 0 | YYYY_YYY       | 0  | 0   | XXh        | 0   | XXh           | 0   | 0 → 1 |

## 7.10 SMBus Read Byte

The Read Byte protocol is used to read one byte of data from the registers as shown in [Table 7-3](#).

**TABLE 7-3: READ BYTE PROTOCOL**

| START | Client Address | WR | ACK | Register Address | ACK  |       |
|-------|----------------|----|-----|------------------|------|-------|
| 1 → 0 | YYYY_YYY       | 0  | 0   | XXh              | 0    |       |
| START | Client Address | RD | ACK | Register Data    | NACK | STOP  |
| 1 → 0 | YYYY_YYY       | 1  | 0   | XXh              | 1    | 0 → 1 |

## 7.11 Block Write

The Block Write is used to write multiple data bytes to a group of contiguous registers, as shown in [Table 7-4](#). It is an extension of the Write Byte Protocol.

**Note:** The Block Write and Block Read protocols require that the address pointer be automatically incremented. For a write command, the address pointer will be automatically incremented when the ACK is sent to the host. There are no over or under bound limit checking and the address pointer will wrap around from FFh to 00h if necessary.

**TABLE 7-4: BLOCK WRITE PROTOCOL**

| START | Client Address | WR | ACK | Register Address | ACK | Repeat N Times |     | STOP  |
|-------|----------------|----|-----|------------------|-----|----------------|-----|-------|
|       |                |    |     |                  |     | Register Data  | ACK |       |
| 1 → 0 | YYYY_YYY       | 0  | 0   | XXh              | 0   | XXh            | 0   | 0 → 1 |

## 7.12 Block Read

The Block Read is used to read multiple data bytes from a group of contiguous registers, as shown in [Table 7-5](#). It is an extension of the Read Byte Protocol.

**TABLE 7-5: BLOCK READ PROTOCOL**

| START | Client Address | WR | ACK | Register Address | ACK |               |      |       |
|-------|----------------|----|-----|------------------|-----|---------------|------|-------|
| 1 → 0 | YYYY_YYY       | 0  | 0   | XXh              | 0   |               |      |       |
| START | Client Address | RD | ACK | Repeat N Times   |     | Register Data | NACK | STOP  |
|       |                |    |     | Register Data    | ACK |               |      |       |
| 1 → 0 | YYYY_YYY       | 1  | 0   | XXh              | 0   | XXh           | 1    | 0 → 1 |

## 7.13 SMBus Send Byte

The Send Byte protocol is used to set the internal address register pointer to the correct address location. No data is transferred during the Send Byte protocol as shown in [Table 7-6](#).

**Note:** The SMBus Send Byte command is expected to be followed by the SMBus Receive Byte command. When two SMBus Send Byte commands are sent in a row, the first command receives an ACK and will be processed by the UCS2113, but the second command receives a NACK and will be ignored.

**TABLE 7-6: SEND BYTE PROTOCOL**

| START | Client Address | WR | ACK | Register Address | ACK | STOP  |
|-------|----------------|----|-----|------------------|-----|-------|
| 1→0   | YYYY_YYY       | 0  | 0   | XXh              | 0   | 0 → 1 |

## 7.14 SMBus Receive Byte

The Receive Byte protocol is used to read data from a register when the internal register address pointer is known to be at the right location (e.g. set via Send Byte). This is used for consecutive reads of the same register as shown in [Table 7-7](#).

**TABLE 7-7: RECEIVE BYTE PROTOCOL**

| START | Client Address | RD | ACK | Register Data | NACK | STOP  |
|-------|----------------|----|-----|---------------|------|-------|
| 1→0   | YYYY_YYY       | 1  | 0   | XXh           | 1    | 0 → 1 |

### 7.14.1 STAND-ALONE OPERATING MODE

Stand-Alone mode allows the UCS2113 to operate without active SMBus/I<sup>2</sup>C communications. Stand-Alone mode can be enabled by connecting a pull-down resistor greater or equal to 47 kΩ on the COMM\_ILIM pin as shown in [Table 5-3](#). The SMCLK pin should be tied to ground in this mode.

# UCS2113

## 8.0 REGISTER DESCRIPTION

The registers shown in [Table 8-1](#) are accessible through the SMBus or I<sup>2</sup>C. An entry of ‘—’ indicates that the bit is not used. Writing to these bits will have no effect and reading these bits will return ‘0’. Writing to a reserved bit may cause unexpected results and reading from a reserved bit will return either ‘1’ or ‘0’ as indicated in the bit description. While in the Sleep state, the UCS2113 will retain configuration and charge rationing data as indicated in the text. If a register does not indicate that data will be retained in the Sleep power state, this information will be lost when the UCS2113 enters the Sleep power state.

**TABLE 8-1: REGISTER SET IN HEXADECIMAL ORDER**

| Register Address | Register Name                                    | R/W      | Function   | Default Value | Page No.           |
|------------------|--|----------|--|---------------|--------------------|
| 00h              | Port 1 Current Measurement                       | R        | Stores the current measurement for Port 1                              | 00h           | <a href="#">33</a> |
| 01h              | Port 2 Current Measurement                       | R        | Stores the current measurement for Port 2                              | 00h           | <a href="#">33</a> |
| 02h              | Port Status                                      | R        | Indicates Port and general status                                      | 00h           | <a href="#">34</a> |
| 03h              | Interrupt Status1                                | See Text | Indicates why ALERT# pin asserted for Port 1                           | 00h           | <a href="#">35</a> |
| 04h              | Interrupt Status2                                | See Text | Indicates why ALERT# pin asserted for Port 2                           | 00h           | <a href="#">37</a> |
| 0Fh              | General Status1                                  | R/R-C    | Indicates General Status for Port 1                                    | 00h           | <a href="#">39</a> |
| 10h              | General Status2                                  | R/R-C    | Indicates General Status for Port 2                                    | 00h           | <a href="#">40</a> |
| 11h              | General Configuration1                           | R/W      | Controls basic functionality for Port 1                                | 06h           | <a href="#">41</a> |
| 12h              | General Configuration2                           | R/W      | Controls basic functionality for Port 2                                | 02h           | <a href="#">42</a> |
| 13h              | General Configuration3                           | R/W      | Controls other functionality   | 60h           | <a href="#">43</a> |
| 14h              | Current Limit                                    | R/W      | Controls/Displays MAX Current Limit per port                           | 00h           | <a href="#">44</a> |
| 15h              | Auto-Recovery Configuration                      | R/W      | Controls the Auto-Recovery functionality                               | 2Ah           | <a href="#">45</a> |
| 16h              | Port 1 Total Accumulated Charge High Byte        | R        | Stores the total accumulated charge delivered high byte, Port 1        | 00h           | <a href="#">46</a> |
| 17h              | Port 1 Total Accumulated Charge Middle High Byte | R        | Stores the total accumulated charge delivered middle high byte, Port 1 | 00h           | <a href="#">46</a> |
| 18h              | Port 1 Total Accumulated Charge Middle Low Byte  | R        | Stores the total accumulated charge delivered middle low byte, Port 1  | 00h           | <a href="#">46</a> |
| 19h              | Port 1 Total Accumulated Charge Low Byte         | R        | Stores the total accumulated charge delivered low byte, Port 1         | 00h           | <a href="#">46</a> |
| 1Ah              | Port 2 Total Accumulated Charge High Byte        | R        | Stores the total accumulated charge delivered high byte, Port 2        | 00h           | <a href="#">47</a> |
| 1Bh              | Port 2 Total Accumulated Charge Middle High Byte | R        | Stores the total accumulated charge delivered middle high byte, Port 2 | 00h           | <a href="#">47</a> |
| 1Ch              | Port 2 Total Accumulated Charge Middle Low Byte  | R        | Stores the total accumulated charge delivered middle low byte, Port 2  | 00h           | <a href="#">47</a> |
| 1Dh              | Port 2 Total Accumulated Charge Low Byte         | R        | Stores the total accumulated charge delivered low byte, Port 2         | 00h           | <a href="#">47</a> |
| 1Eh              | Port 1 Charge Rationing Threshold High Byte      | R/W      | Sets the maximum allowed charge that will be delivered to Port 1       | FFh           | <a href="#">48</a> |
| 1Fh              | Port 1 Charge Rationing Threshold Low Byte       | R/W      | Sets the maximum allowed charge that will be delivered to Port 1       | FFh           | <a href="#">48</a> |
| 20h              | Port 2 Charge Rationing Threshold High Byte      | R/W      | Sets the maximum allowed charge that will be delivered to Port 2       | FFh           | <a href="#">48</a> |



**TABLE 8-1: REGISTER SET IN HEXADECIMAL ORDER (CONTINUED)**

| Register Address | Register Name                              | R/W | Function   | Default Value | Page No. |
|------------------|--|-----|--|---------------|----------|
| 21h              | Port 2 Charge Rationing Threshold Low Byte | R/W | Sets the maximum allowed charge that will be delivered to Port 2     | FFh           | 48       |
| 22h              | Ration Configuration                       | R/W | Controls Charge Ration Functionality                                 | 11h           | 49       |
| 23h              | Port 1 Current Limit Behavior              | R/W | Controls the Current Limiting Behavior (CC Mode Region 2) for Port 1 | 96h           | 50       |
| 24h              | Port 2 Current Limit Behavior              | R/W | Controls the Current Limiting Behavior (CC Mode Region 2) for Port 2 | 96h           | 50       |
| FDh              | Product ID                                 | R   | Stores a fixed value that identifies each product                    | E1h           | 51       |
| FEh              | Manufacturer ID                            | R   | Stores a fixed value that identifies Microchip                       | 5Dh           | 51       |
| FFh              | Revision                                   | R   | Stores a fixed value that represents the revision number             | 81h           | 52       |

## 8.1 Current Measurement Register

The Current Measurement register stores the measured current value delivered to the portable device ( $I_{BUS}$ ). This value is updated continuously while the device is in the Active power state.

**REGISTER 8-1: PORTS 1 AND 2 CURRENT MEASUREMENT REGISTERS (ADDRESSES 00H, 01H)**

|            |     |     |     |     |     |     |       |
|------------|-----|-----|-----|-----|-----|-----|-------|
| R-0        | R-0 | R-0 | R-0 | R-0 | R-0 | R-0 | R-0   |
| CM(x)<7:0> |     |     |     |     |     |     |       |
| bit 7      |     |     |     |     |     |     | bit 0 |

**Legend:**

R = Readable bit                      W = Writable bit                      U = Unimplemented bit  
 -n = Value at POR                      '1' = Bit is set                      '0' = Bit is cleared                      x = Bit is unknown

bit 7-0                      **CM(x)<7:0>**: Port X Current Measurement, where x=1 or 2 (address 00h for Port 1 and address 01h for Port 2).

- Note 1:** The bit weights are in mA, 1 LSB = 13.3 mA (maximum value is 255 LSB corresponding to 3.4A).  
**2:** This data will be cleared when the device enters the Sleep state. This data will also be cleared whenever the port power switch is turned off (or any time that  $V_{BUS}$  is discharged).

# UCS2113

## 8.2 Status Registers

The Status registers store bits that indicate the state of the ALERT# pins and if the ports operate in Constant Current Mode.

### REGISTER 8-2: PORT STATUS REGISTER (ADDRESS 02H)

|            |            |          |          |     |     |     |       |
|------------|------------|----------|----------|-----|-----|-----|-------|
| R-0        | R-0        | R-0      | R-0      | U-0 | U-0 | R-x | R-x   |
| ALERT2_PIN | ALERT1_PIN | CC_MODE2 | CC_MODE1 | —   | —   | —   | —     |
| bit 7      |            |          |          |     |     |     | bit 0 |

#### Legend:

R = Readable bit

W = Writable bit

U = Unimplemented bit

-n = Value at POR

'1' = Bit is set

'0' = Bit is cleared

x = Bit is unknown

- bit 7      **ALERT2\_PIN:** Reflects the status of the ALERT#2 pin. This bit is set and cleared as the ALERT#2 pin changes states.  
1 = ALERT#2 Pin asserted (logic low)  
0 = ALERT#2 Pin not asserted
- bit 6      **ALERT1\_PIN:** Reflects the status of the ALERT#1 pin. This bit is set and cleared as the ALERT#1 pin changes states.  
1 = ALERT#1 Pin asserted (logic low)  
0 = ALERT#1 Pin not asserted
- bit 5      **CC\_MODE2:** Port 2 Constant Current Mode State  
1 = Port 2 in Constant Current mode  
0 = Port 2 operating normally
- bit 4      **CC\_MODE1:** Port 1 Constant Current Mode State  
1 = Port 1 in Constant Current mode  
0 = Port 1 operating normally
- bit 3-0    **Unimplemented**

## REGISTER 8-3: INTERRUPT STATUS 1 REGISTER (ADDRESS 03H)

|       |            |       |           |          |         |         |         |
|-------|------------|-------|-----------|----------|---------|---------|---------|
| R/W-0 | R/C-0      | R/C-0 | R/C-0     | R/C-0    | R/C-0   | R/C-0   | R/C-0   |
| ERR1  | DISCH_ERR1 | RESET | KEEP_OUT1 | TSD_HIGH | OV_VOLT | BACK_V1 | OV_LIM1 |
| bit 7 |            |       |           |          |         |         | bit 0   |

### Legend:

|                   |                  |                       |                    |
|-------------------|------------------|-----------------------|--------------------|
| R = Readable bit  | W = Writable bit | U = Unimplemented bit | C = Clear on Read  |
| -n = Value at POR | '1' = Bit is set | '0' = Bit is cleared  | x = Bit is unknown |

bit 7 **ERR1:** Error Port 1 - Indicates that an error was detected on the  $V_{BUS1}$  pin and the device has entered the Error state. Writing this bit to '0' will clear the Error state and allows the device to be returned to the Active state. When written to '0', all error conditions are checked. If all error conditions have been removed, the UCS2113 returns to the Active state. This bit is set automatically by the UCS2113 when the Error state is entered. If any other bit is set in the Interrupt Status register (03h), the device will not leave the Error state.

This bit is cleared automatically by the UCS2113 if the Auto-recovery fault handling functionality is active and no error conditions are detected. Likewise, this bit is cleared when the PWR\_EN1 control is disabled ([Note 1](#)).

- 1 = Port 1 in Error State
- 0 = Port 1 in Active State (no errors detected)

bit 6 **DISCH\_ERR1:** Discharge Error Port 1 - Indicates the device was unable to discharge Port1. This bit will be cleared when read if the error condition has been removed or if the ERR bit is cleared. This bit will cause the ALERT#1 pin to be asserted and the device to enter the Error state.

- 1 = UCS2113 was unable to Discharge  $V_{BUS1}$
- 0 = No  $V_{BUS1}$  discharge error

bit 5 **RESET:** Indicates that the UCS2113 has just been reset and should be reprogrammed. This bit will be set at power-up. This bit is cleared when read or when the PWR\_EN control is toggled. The ALERT# pins are not asserted when this bit is set. This data is retained in the Sleep state.

- 1 = UCS2113 has just been reset
- 0 = Reset did not occur

bit 4 **KEEP\_OUT1:** Port 1 Minimum Keep-Out region - Indicates that the V-I output on the  $V_{BUS1}$  pin has dropped below  $V_{BUS\_MIN}$ . This bit will be cleared when read if the error condition has been removed or if the ERR1 bit is cleared. This bit will cause the ALERT#1 pin to be asserted and the device to enter the Error state.

- 1 =  $V_{BUS1} < V_{BUS\_MIN}$
- 0 =  $V_{BUS1} > V_{BUS\_MIN}$

bit 3 **TSD\_HIGH:** Indicates that the internal temperature has exceeded  $T_{TSD\_HIGH}$  threshold and the device has entered the Error state. This bit will be cleared when read if the error condition has been removed or if the ERR1 bit is cleared. This bit will cause the ALERT#1 and ALERT#2 pins to be asserted and the device to enter the Error state.

- 1 = Internal die temperature has exceeded  $T_{TSD\_HIGH}$
- 0 = Internal die temperature has not exceeded  $T_{TSD\_HIGH}$

bit 2 **OV\_VOLT:**  $V_S$  Overvoltage indicates that the  $V_S$  voltage has exceeded the  $V_{S\_OV}$  threshold, and the device has entered the Error state. This bit will be cleared when read if the error condition has been removed or if the ERR1 bit is cleared. This bit will cause the ALERT#1 and ALERT#2 pins to be asserted and the device to enter the Error state.

- 1 =  $V_S > V_{S\_OV}$
- 0 =  $V_S < V_{S\_OV}$

## REGISTER 8-3: INTERRUPT STATUS 1 REGISTER (ADDRESS 03H) (CONTINUED)

- bit 1      **BACK\_V1:** Back-Bias Voltage Port 1 - Indicates that the  $V_{BUS1}$  voltage has exceeded the  $V_S$  or  $V_{DD}$  voltages by more than 150 mV. This bit will be cleared when read if the error condition has been removed or if the ERR1 bit is cleared. This bit will cause the ALERT#1 pin to be asserted and the device to enter the Error state.
- 1 =  $V_{BUS1} > V_S$ , or  $V_{BUS1} > V_{DD}$  by more than 150 mV.
  - 0 =  $V_{BUS1}$  voltage has not exceeded the  $V_S$  and  $V_{DD}$  voltages by more than 150 mV.
- bit 0      **OV\_LIM1:** Over Current Limit Port 1 - Indicates that the  $I_{BUS}$  current has exceeded both the  $I_{LIM}$  threshold and the  $I_{BUS\_R2MIN}$  threshold settings for  $V_{BUS1}$ . This bit will be cleared when read if the error condition has been removed or if the ERR1 bit is cleared. This bit will cause the ALERT#1 pin to be asserted and the device to enter the Error state.
- 1 = Current Limit for Port 1 exceeded
  - 0 = Current Limit for Port 1 not exceeded

**Note 1:** Note that the ERR1 bit does not necessarily reflect the ALERT#1 pin status. The ALERT#1 pin may be cleared or asserted without the ERR1 bit changing states.

## REGISTER 8-4: INTERRUPT STATUS 2 REGISTER (ADDRESS 04H)

|       |            |        |           |         |     |         |         |
|-------|------------|--------|-----------|---------|-----|---------|---------|
| R/W-0 | R/C-0      | R-0    | R/C-0     | R/C-0   | U-0 | R/C-0   | R/C-0   |
| ERR2  | DISCH_ERR2 | VS_LOW | KEEP_OUT2 | TSD_LOW | —   | BACK_V2 | OV_LIM2 |
| bit 7 |            |        |           |         |     | bit 0   |         |

### Legend:

|                   |                  |                       |                    |
|-------------------|------------------|-----------------------|--------------------|
| R = Readable bit  | W = Writable bit | U = Unimplemented bit | C = Clear on Read  |
| -n = Value at POR | '1' = Bit is set | '0' = Bit is cleared  | x = Bit is unknown |

- bit 7 **ERR2:** Error Port 2 - Indicates that an error was detected on the  $V_{BUS1}$  pin and the device has entered the Error state. Writing this bit to a '0' will clear the Error state and allows the device to be returned to the Active state. When written to '0', all error conditions are checked. If all error conditions have been removed, the UCS2113 returns to the Active state. This bit is set automatically by the UCS2113 when the Error state is entered. If any other bit is set in the Interrupt Status register (04h), the device will not leave the Error state. This bit is cleared automatically by the UCS2113 if the auto-recovery fault handling functionality is active and no error conditions are detected. Likewise, this bit is cleared when the PWR\_EN2 control is disabled (Note 1).
- 1 = Port 2 in Error State
  - 0 = Port 2 in Active State (no errors detected)
- bit 6 **DISCH\_ERR2:** Discharge Error Port 2 - Indicates the device was unable to discharge Port2. This bit will be cleared when read if the error condition has been removed or if the ERR bit is cleared. This bit will cause the ALERT#2 pin to be asserted and the device to enter the Error state.
- 1 = Device was unable to Discharge  $V_{BUS2}$
  - 0 = No  $V_{BUS2}$  discharge error
- bit 5 **VS\_LOW:** Indicates that the  $V_S$  voltage has fallen below the  $V_{S\_UVLO}$  threshold and both  $V_{BUS1}$  and  $V_{BUS2}$  port power switches are held off. This bit is cleared automatically when the  $V_S$  voltage is above the  $V_{S\_UVLO}$  threshold.
- 1 =  $V_S$  voltage has fallen below the  $V_{S\_UVLO}$
  - 0 =  $V_S$  voltage is above  $V_{S\_UVLO}$
- bit 4 **KEEP\_OUT2:** Port 2 Minimum Keep-out region - Indicates that the V-I output on the  $V_{BUS2}$  pin has dropped below  $V_{BUS\_MIN}$ . This bit will be cleared when read if the error condition has been removed or if the ERR2 bit is cleared. This bit will cause the ALERT#2 pin to be asserted and the device to enter the Error state.
- 1 =  $V_{BUS2} < V_{BUS\_MIN}$
  - 0 =  $V_{BUS2} > V_{BUS\_MIN}$
- bit 3 **TSD\_LOW:** Indicates that the die temperature has exceeded the  $T_{TSD\_LOW}$  threshold and it is still above the  $T_{TSD\_LOW} - T_{TSD\_LOW\_HYST}$ . This bit is cleared automatically when the die temperature is below the  $T_{TSD\_LOW} - T_{TSD\_LOW\_HYST}$ . This bit will not cause the corresponding ALERT#1 and/or ALERT#2 pins to be asserted and ERR1 and/or ERR2 bits to be set unless:
- a power switch operates in constant current mode
  - PWR\_EN1 and/or PWR\_EN2 controls transition from inactive to active
  - it is a power up situation and PWR\_EN1 and/or PWR\_EN2 pins are active.
- 1 = Internal die temperature has exceeded  $T_{TSD\_LOW}$
  - 0 = Internal die temperature has not exceeded  $T_{TSD\_LOW}$
- bit 2 **Unimplemented:** Read as '0'
- bit 1 **BACK\_V2:** Back-Bias Voltage Port 2 - Indicates that the  $V_{BUS2}$  voltage has exceeded the  $V_S$  or  $V_{DD}$  voltages by more than 150 mV. This bit will be cleared when read if the error condition has been removed or if the ERR2 bit is cleared. This bit will cause the ALERT#2 pin to be asserted and the device to enter the Error state.
- 1 =  $V_{BUS2} > V_S$ , or  $V_{BUS2} > V_{DD}$  by more than 150 mV
  - 0 =  $V_{BUS2}$  voltage has not exceeded the  $V_S$  and  $V_{DD}$  voltages by more than 150 mV

## REGISTER 8-4: INTERRUPT STATUS 2 REGISTER (ADDRESS 04H) (CONTINUED)

bit 0      **OV\_LIM2**: Overcurrent Limit Port 2 - Indicates that the  $I_{BUS}$  current has exceeded both the  $I_{LIM}$  threshold and the  $I_{BUS\_R2MIN}$  threshold settings for  $V_{BUS2}$ . This bit will be cleared when read if the error condition has been removed or if the ERR2 bit is cleared. This bit will cause the ALERT#2 pin to be asserted and the device to enter the Error state.

1 = Current Limit for Port 2 exceeded

0 = Current Limit for Port 2 not exceeded

**Note 1:** Note that the ERR2 bit does not necessarily reflect the ALERT#2 pin status. The ALERT#2 pin may be cleared or asserted without the ERR2 bit changing states.

## REGISTER 8-5: GENERAL STATUS 1 REGISTER (ADDRESS 0FH)

|         |     |     |          |             |     |     |       |
|---------|-----|-----|----------|-------------|-----|-----|-------|
| R/C-0   | U-x | U-x | R-0      | R-0         | U-x | U-x | U-x   |
| RATION1 | —   | —   | CC_MODE1 | PWR_EN1_CON | —   | —   | —     |
| bit 7   |     |     |          |             |     |     | bit 0 |

### Legend:

|                   |                  |                       |                    |
|-------------------|------------------|-----------------------|--------------------|
| R = Readable bit  | W = Writable bit | U = Unimplemented bit | C = Clear on Read  |
| -n = Value at POR | '1' = Bit is set | '0' = Bit is cleared  | x = Bit is unknown |

- bit 7      **RATION1:** Indicates the state of Port 1 Rationing. This bit is cleared when read, or cleared automatically when the RATION\_RST1 bit is set or the RATION\_EN1 bit is cleared.  
 1 = Port 1 has delivered the programmed mAh of current  
 0 = Port 1 has not delivered the programmed mAh of current
- bit 6-5    **Unimplemented**
- bit 4      **CC\_MODE1:** Indicates whether Port 1 has entered CC mode.  
 1 = Port 1 is in CC mode  
 0 = Port 1 not in CC mode
- bit 3      **PWR\_EN1\_CON:** Reflects the PWR\_EN control state. This bit is set and cleared automatically with the logic expression (PWR\_EN1 pin OR PWR\_EN1S).  
 1 = Port 1 Power Enable is set  
 0 = Port 1 Power Enable is clear
- bit 2-0    **Unimplemented**

# UCS2113

## REGISTER 8-6: GENERAL STATUS 2 REGISTER (ADDRESS 10H)

|         |     |     |          |             |     |     |       |
|---------|-----|-----|----------|-------------|-----|-----|-------|
| R/C-0   | U-x | U-x | R-0      | R-0         | U-x | U-x | U-x   |
| RATION2 | —   | —   | CC_MODE2 | PWR_EN2_CON | —   | —   | —     |
| bit 7   |     |     |          |             |     |     | bit 0 |

### Legend:

|                   |                  |                       |                    |
|-------------------|------------------|-----------------------|--------------------|
| R = Readable bit  | W = Writable bit | U = Unimplemented bit | C = Clear on Read  |
| -n = Value at POR | '1' = Bit is set | '0' = Bit is cleared  | x = Bit is unknown |

bit 7 **RATION2:** Indicates the state of Port 2 Rationing. This bit is cleared when read, or cleared automatically when the RATION\_RST2 bit is set or the RATION\_EN2 bit is cleared.

- 1 = Port 2 has delivered the programmed mAh of current
- 0 = Port 2 has not delivered the programmed mAh of current

bit 6-5 **Unimplemented**

bit 4 **CC\_MODE2:** Indicates whether Port 2 has entered CC mode.

- 1 = Port 2 is in CC mode
- 0 = Port 2 not in CC mode

bit 3 **PWR\_EN2\_CON:** Reflects the PWR\_EN control state. This bit is set and cleared automatically with the logic expression (PWR\_EN2 pin OR. PWR\_EN2S).

- 1 = Port 2 Power Enable is set
- 0 = Port 2 Power Enable is clear

bit 2-0 **Unimplemented**



## 8.3 Configuration Registers

The Configuration registers control basic device functionality. The contents of these registers are retained in Sleep.

### REGISTER 8-7: GENERAL CONFIGURATION 1 REGISTER (ADDRESS 11H)

|             |     |        |          |                  |       |     |       |
|-------------|-----|--------|----------|------------------|-------|-----|-------|
| R/W-0       | U-0 | R/W-0  | R/W-0    | R/W-0            | R/W-1 | U-1 | U-0   |
| ALERT1_MASK | —   | DSCHG1 | PWR_EN1S | DISCHG_TIME<1:0> | —     | —   | —     |
| bit 7       |     |        |          |                  |       |     | bit 0 |

#### Legend:

|                   |                  |                       |                    |
|-------------------|------------------|-----------------------|--------------------|
| R = Readable bit  | W = Writable bit | U = Unimplemented bit | C = Clear on Read  |
| -n = Value at POR | '1' = Bit is set | '0' = Bit is cleared  | x = Bit is unknown |

- bit 7      **ALERT1\_MASK:** Mask errors for all interrupts in [Register 8-3](#) except OV\_LIM1 and TSD.  
 1 = The ALERT#1 pin will only assert if a OV\_LIM1 or TSD is detected  
 0 = The ALERT#1 pin will be asserted if an error condition or indicator event is detected
- bit 6      **Unimplemented**
- bit 5      **DSCHG1:** Forces the VBUS1 to be reset and discharged when the UCS2113 is in the Active state and the EN\_VBUS\_DISCHG bit is logic '1'. Writing this bit to a logic '1' will cause the port power switch to be opened and the discharge circuitry to activate and discharge V<sub>BUS</sub>. Actual discharge time is controlled by DISCHG\_TIME<1:0>. This bit must be cleared by the SMBus host after the forced VBUS discharge.  
 1 = V<sub>BUS1</sub> discharge initiated  
 0 = Port 1 not in discharge
- bit 4      **PWR\_EN1S:** Power Enable Port 1 override - This bit is OR'ed with the PWR\_EN1 pin. Thus, if the polarity is set to active-high, either the PWR\_EN1 pin or this bit must be '1' to enable the port power switch.
- bit 3-2    **DISCHG\_TIME<1:0>:** Discharge time Port 1 - sets t<sub>DISCHARGE</sub>. The discharge time value is the same for both ports.  
 00 = 100 ms  
 01 = 200 ms  
 10 = 300 ms  
 11 = 400 ms
- bit 1-0    **Unimplemented**

# UCS2113

## REGISTER 8-8: GENERAL CONFIGURATION 2 REGISTER (ADDRESS 12H)

|             |     |        |          |   |                |     |       |
|-------------|-----|--------|----------|---|----------------|-----|-------|
| R/W-0       | U-0 | R/W-0  | R/W-0    | U | R/W-0          | U-1 | U-0   |
| ALERT2_MASK | —   | DSCHG2 | PWR_EN2S | — | EN_VBUS_DISCHG | —   | —     |
| bit 7       |     |        |          |   |                |     | bit 0 |

### Legend:

|                   |                  |                       |                    |
|-------------------|------------------|-----------------------|--------------------|
| R = Readable bit  | W = Writable bit | U = Unimplemented bit | C = Clear on Read  |
| -n = Value at POR | '1' = Bit is set | '0' = Bit is cleared  | x = Bit is unknown |

- bit 7      **ALERT2\_MASK:** Mask errors for all interrupts in [Register 8-4](#) except OV\_LIM2 and TSD.  
 1 = The ALERT#2 pin will only assert if a OV\_LIM2 or TSD is detected  
 0 = The ALERT#2 pin will be asserted if an error condition or indicator event is detected
- bit 6      **Unimplemented**
- bit 5      **DSCHG2:** Forces the VBUS2 to be reset and discharged when the UCS2113 is in the Active state and the EN\_VBUS\_DISCHG bit is logic '1'. Writing this bit to a logic '1' will cause the port power switch to be opened and the discharge circuitry to activate to discharge V<sub>BUS</sub>. Actual discharge time is controlled by DISCHG\_TIME<1:0>. This bit must be cleared by the SMBus host after the forced VBUS discharge.  
 1 = V<sub>BUS2</sub> discharge initiated  
 0 = Port 2 not in discharge
- bit 4      **PWR\_EN2S:** Power Enable Port 2 override - This bit is OR'ed with the PWR\_EN2 pin. Thus, if the polarity is set to active-high, either the PWR\_EN2 pin or this bit must be '1' to enable the port power switch.
- bit 3      **Unimplemented**
- bit 2      **EN\_VBUS\_DISCHG:** Enables V<sub>BUS</sub> discharge circuitry.  
 If it is '0', it completely disables all the automatic V<sub>BUS</sub> discharges from happening and allows only manual VBUS discharges (the SMBus host must set and clear DISCHG\_LOAD1 and DISCHG\_LOAD2 bits from the Current Limit Behavior Registers 23h and 24h). Setting DSCHG1 and DSCHG2 bits from the General Configuration 1 and 2 registers 11h and 12h does not have any effect in this case ([Note 1](#)).  
 If it is '1', the V<sub>BUS</sub> is discharged automatically as described in [Section 6.4, V<sub>BUS</sub> Discharge](#). The VBUS can be discharged manually by the SMBus host only by setting DSCHG1 and DSCHG2 bits from the General Configuration 1 and 2 Registers 11h and 12h. Setting DISCHG\_LOAD1 and DISCHG\_LOAD2 bits from the Current Limit Behavior Registers 23h and 24h doesn't have any effect in this case.
- bit 1-0      **Unimplemented**
- Note 1:** When the automatic VBUS discharges are disabled (EN\_VBUS\_DISCHG is '0'), the UCS2113 will not check that the VBUS voltage is below the VTEST level after the manual VBUS discharges.

## REGISTER 8-9: GENERAL CONFIGURATION 3 REGISTER (ADDRESS 13H)

|         |     |        |     |     |       |       |     |
|---------|-----|--------|-----|-----|-------|-------|-----|
| R/W-0   | U-1 | R/W-1  | U-x | U-x | R/W-0 | U-0   | U-0 |
| PIN_IGN | —   | DIS_TO | —   | —   | BOOST | —     | —   |
| bit 7   |     |        |     |     |       | bit 0 |     |

### Legend:

|                   |                  |                       |                    |
|-------------------|------------------|-----------------------|--------------------|
| R = Readable bit  | W = Writable bit | U = Unimplemented bit | C = Clear on Read  |
| -n = Value at POR | '1' = Bit is set | '0' = Bit is cleared  | x = Bit is unknown |

- bit 7      **PIN\_IGN:** Ignores the PWR\_EN1 and PWR\_EN2 pin states when determining the power state. This bit is retained in Sleep.  
             1 = PWR\_EN1 and PWR\_EN2 pin states are ignored.  
             0 = Power state is determined by the OR'd combination of the PWR\_EN1 and PWR\_EN2 pins states and the corresponding PWR\_EN1S and PWR\_EN2S bit states.
- bit 6      **Unimplemented**
- bit 5      **DIS\_TO:** Disable Time Out - Disables the SMBus time out feature.  
             1 = Time out disabled  
             0 = Time out enabled
- bit 4-3    **Unimplemented**
- bit 2      **BOOST:** Indicates that the I<sub>BUS</sub> current is higher than I<sub>BOOST</sub> on V<sub>BUS1</sub> or V<sub>BUS2</sub> (bit is OR'ed).  
             1 = I<sub>BUS</sub> has exceeded I<sub>BOOST</sub> on either or both ports  
             0 = I<sub>BUS</sub> is less than I<sub>BOOST</sub> on either port individually
- bit 1-0    **Unimplemented:** Read as '0'

# UCS2113

## 8.4 Current Limit Register

The Current Limit register controls the  $I_{LIM}$  used by the port power switch. The default setting is based on the resistor on the COMM\_ILIM pin and this value cannot be changed to be higher than hardware set value. The contents of this register are retained in Sleep.

### REGISTER 8-10: CURRENT LIMIT REGISTER (ADDRESS 14H)

|       |     |                 |       |       |                 |       |       |
|-------|-----|-----------------|-------|-------|-----------------|-------|-------|
| U-0   | U-0 | R/W-0           | R/W-0 | R/W-0 | R/W-0           | R/W-0 | R/W-0 |
| —     | —   | ILIM_PORT2<2:0> |       |       | ILIM_PORT1<2:0> |       |       |
| bit 7 |     |                 |       |       |                 |       | bit 0 |

#### Legend:

|                   |                  |                       |                    |
|-------------------|------------------|-----------------------|--------------------|
| R = Readable bit  | W = Writable bit | U = Unimplemented bit |                    |
| -n = Value at POR | '1' = Bit is set | '0' = Bit is cleared  | x = Bit is unknown |

bit 7-6 **Unimplemented:** Read as '0'

bit 5-3 **ILIM\_PORT2<2:0>:** Sets the  $I_{LIM}$  value for Port 2

000 = 0.53A  
001 = 0.96A  
010 = 1.07A  
011 = 1.28A  
100 = 1.6A  
101 = 2.13A  
110 = 2.67A  
111 = 3.2A

bit 2-0 **ILIM\_SW<2:0>:** Sets the  $I_{LIM}$  value for Port 1

000 = 0.53A  
001 = 0.96A  
010 = 1.07A  
011 = 1.28A  
100 = 1.6A  
101 = 2.13A  
110 = 2.67A  
111 = 3.2A

## 8.5 Auto-Recovery Register

The contents of this register are retained in Sleep.

The Auto-Recovery Configuration register sets the parameters used when the Auto-Recovery fault handling algorithm is invoked. Once the Auto-Recovery fault handling algorithm has checked the overtemperature and back-drive conditions, it will set the  $I_{LIM}$  value to  $I_{TEST}$  and then turn on the port power switch and start the  $t_{TST}$  timer. If, after the timer has expired, the  $V_{BUS}$  voltage is less than  $V_{TEST}$ , then it is assumed that a short-circuit condition is present and the Error state is restarted for Auto Recovery.

**REGISTER 8-11: AUTO RECOVERY CONFIGURATION REGISTER (ADDRESS 15H)**

|        |             |       |       |           |       |              |       |
|--------|-------------|-------|-------|-----------|-------|--------------|-------|
| R/W-0  | R/W-0       | R/W-1 | R/W-0 | R/W-1     | R/W-0 | R/W-1        | R/W-0 |
| LATCHS | TCYCLE<2:0> |       |       | TTST<1:0> |       | VTST_SW<1:0> |       |
| bit 7  |             |       |       |           |       |              | bit 0 |

**Legend:**

|                   |                  |                       |
|-------------------|------------------|-----------------------|
| R = Readable bit  | W = Writable bit | U = Unimplemented bit |
| -n = Value at POR | '1' = Bit is set | '0' = Bit is cleared  |
|                   |                  | x = Bit is unknown    |

- bit 7      **LATCHS:** Latch Set - Controls the fault-handling routine that is used in the case that an error is detected.
  - 1 = Error state will be latched. In order for the UCS2113 to return to normal Active state, the ERR bit must be cleared by the user.
  - 0 = The UCS2113 will automatically retry when an error condition is detected.
- bit 6-4    **TCYCLE<2:0>:** Defines the delay ( $t_{CYCLE}$ ) after the Error state is entered before the Auto-Recovery fault handling algorithm is started as shown below.
  - 000 = 15 ms
  - 001 = 20 ms
  - 010 = 25 ms
  - 011 = 30 ms
  - 100 = 35 ms
  - 101 = 40 ms
  - 110 = 45 ms
  - 111 = 50 ms
- bit 3-2    **TTST<1:0>:** Retry Duration timer - Sets the  $t_{TST}$  as shown below
  - 00 = 10 ms
  - 01 = 15 ms
  - 10 = 20 ms
  - 11 = 25 ms
- bit 1-0    **VTST\_SW:** Short-circuit voltage threshold  $V_{TEST}$  that must be crossed during retries to declare the short removed
  - 00 = 250 mV
  - 01 = 500 mV
  - 10 = 750 mV
  - 11 = 1000 mV

# UCS2113

## 8.6 Total Accumulated Charge Registers

The Total Accumulated Charge registers store the total accumulated charge delivered from the  $V_S$  source to a portable device. The bit weighting of the registers is given in mA-hrs. The register value is reset to 00\_00h only when the RATION\_RST bit is set or if the RATION\_EN bit is cleared. This value will be retained when the device transitions out of the Active state and resumes accumulation, if the device returns to the Active state and charge rationing is still enabled.

These registers are updated every one (1) second while the UCS2113 is in the Active power state. Every time the value is updated, it is compared against the target value in the Charge Rationing Threshold registers. This data is retained in the Sleep state.

### REGISTER 8-12: PORT1 TOTAL ACCUMULATED CHARGE REGISTERS (ADDRESS 16H, 17H, 18H, 19H)

|             |     |     |     |        |     |     |     |
|-------------|-----|-----|-----|--------|-----|-----|-----|
| R-0         | R-0 | R-0 | R-0 | R-0    | R-0 | R-0 | R-0 |
| TAC1<25:18> |     |     |     |        |     |     |     |
| bit 31      |     |     |     | bit 24 |     |     |     |

|             |     |     |     |        |     |     |     |
|-------------|-----|-----|-----|--------|-----|-----|-----|
| R-0         | R-0 | R-0 | R-0 | R-0    | R-0 | R-0 | R-0 |
| TAC1<17:10> |     |     |     |        |     |     |     |
| bit 23      |     |     |     | bit 16 |     |     |     |

|           |     |     |     |       |     |     |     |
|-----------|-----|-----|-----|-------|-----|-----|-----|
| R-0       | R-0 | R-0 | R-0 | R-0   | R-0 | R-0 | R-0 |
| TAC1<9:2> |     |     |     |       |     |     |     |
| bit 15    |     |     |     | bit 8 |     |     |     |

|           |     |     |     |       |     |     |     |
|-----------|-----|-----|-----|-------|-----|-----|-----|
| R-0       | R-0 | U-0 | U-0 | U-0   | U-0 | U-0 | U-0 |
| TAC1<1:0> |     | —   | —   | —     | —   | —   | —   |
| bit 7     |     |     |     | bit 0 |     |     |     |

#### Legend:

R = Readable bit      W = Writable bit      U = Unimplemented bit  
 -n = Value at POR      '1' = Bit is set      '0' = Bit is cleared      x = Bit is unknown

bit 31-6      **TAC1<25:0>**: Total Accumulated Charge Port 1 - Each LSB of this 26-bit value equals 0.00367 mAh  
 bit 5-0      **Unimplemented**: Read as '0'

**REGISTER 8-13: PORT2 TOTAL ACCUMULATED CHARGE REGISTERS (ADDRESS 1AH,1BH,1CH,1DH)**

|             |     |     |     |        |     |     |     |
|-------------|-----|-----|-----|--------|-----|-----|-----|
| R-0         | R-0 | R-0 | R-0 | R-0    | R-0 | R-0 | R-0 |
| TAC2<25:18> |     |     |     |        |     |     |     |
| bit 31      |     |     |     | bit 24 |     |     |     |

|             |     |     |     |        |     |     |     |
|-------------|-----|-----|-----|--------|-----|-----|-----|
| R-0         | R-0 | R-0 | R-0 | R-0    | R-0 | R-0 | R-0 |
| TAC2<17:10> |     |     |     |        |     |     |     |
| bit 23      |     |     |     | bit 16 |     |     |     |

|           |     |     |     |       |     |     |     |
|-----------|-----|-----|-----|-------|-----|-----|-----|
| R-0       | R-0 | R-0 | R-0 | R-0   | R-0 | R-0 | R-0 |
| TAC2<9:2> |     |     |     |       |     |     |     |
| bit 15    |     |     |     | bit 8 |     |     |     |

|           |     |     |     |       |     |     |     |
|-----------|-----|-----|-----|-------|-----|-----|-----|
| R-0       | R-0 | U-0 | U-0 | U-0   | U-0 | U-0 | U-0 |
| TAC2<1:0> |     | —   | —   | —     | —   | —   | —   |
| bit 7     |     |     |     | bit 0 |     |     |     |

**Legend:**

|                   |                  |                       |
|-------------------|------------------|-----------------------|
| R = Readable bit  | W = Writable bit | U = Unimplemented bit |
| -n = Value at POR | '1' = Bit is set | '0' = Bit is cleared  |
|                   |                  | x = Bit is unknown    |

bit 31-6     **TAC2<25:0>**: Total Accumulated Charge Port 2 - Each LSB of this 26-bit value equals 0.00367 mAh  
bit 5-0     **Unimplemented**: Read as '0'

## 8.7 Charge Rationing Threshold Registers

The Charge Rationing Threshold registers set the maximum allowed charge that will be delivered to a portable device. Every time the Total Accumulated Charge registers are updated, the value is checked against this limit. If the value meets or exceeds this limit, the RATION(1/2) bit is set and action taken according to the RATION\_BEH1<1:0> and RATION\_BEH2<1:0> bits.

### REGISTER 8-14: PORT 1 CHARGE RATIONING THRESHOLD REGISTERS (ADDRESS 1EH,1FH)

|           |       |       |       |       |       |       |       |
|-----------|-------|-------|-------|-------|-------|-------|-------|
| R/W-1     | R/W-1 | R/W-1 | R/W-1 | R/W-1 | R/W-1 | R/W-1 | R/W-1 |
| CT1<15:8> |       |       |       |       |       |       |       |
| bit 15    |       |       |       | bit 8 |       |       |       |

|          |       |       |       |       |       |       |       |
|----------|-------|-------|-------|-------|-------|-------|-------|
| R/W-1    | R/W-1 | R/W-1 | R/W-1 | R/W-1 | R/W-1 | R/W-1 | R/W-1 |
| CT1<7:0> |       |       |       |       |       |       |       |
| bit 7    |       |       |       | bit 0 |       |       |       |

**Legend:**

R = Readable bit      W = Writable bit      U = Unimplemented bit  
 -n = Value at POR      '1' = Bit is set      '0' = Bit is cleared      x = Bit is unknown

bit 15-0      **CT1<15:0>**: Charge Rationing Threshold Port 1 - Each LSB of this 16-bit value equals 3.76 mAh

### REGISTER 8-15: PORT 2 CHARGE RATIONING THRESHOLD REGISTERS (ADDRESS 20H, 21H)

|           |       |       |       |       |       |       |       |
|-----------|-------|-------|-------|-------|-------|-------|-------|
| R/W-1     | R/W-1 | R/W-1 | R/W-1 | R/W-1 | R/W-1 | R/W-1 | R/W-1 |
| CT2<15:8> |       |       |       |       |       |       |       |
| bit 15    |       |       |       | bit 8 |       |       |       |

|          |       |       |       |       |       |       |       |
|----------|-------|-------|-------|-------|-------|-------|-------|
| R/W-1    | R/W-1 | R/W-1 | R/W-1 | R/W-1 | R/W-1 | R/W-1 | R/W-1 |
| CT2<7:0> |       |       |       |       |       |       |       |
| bit 7    |       |       |       | bit 0 |       |       |       |

**Legend:**

R = Readable bit      W = Writable bit      U = Unimplemented bit  
 -n = Value at POR      '1' = Bit is set      '0' = Bit is cleared      x = Bit is unknown

bit 15-0      **CT2**: Charge Rationing Threshold Port 2 - Each LSB of this 16-bit value equals 3.76 mAh



## REGISTER 8-16: RATION CONFIGURATION REGISTER (ADDRESS 22H)

|         |          |               |       |         |          |               |       |
|---------|----------|---------------|-------|---------|----------|---------------|-------|
| R/W-0   | R/W-0    | R/W-0         | R/W-1 | R/W-0   | R/W-0    | R/W-0         | R/W-1 |
| RTN_EN2 | RTN_RST2 | RTN_BEH2<1:0> |       | RTN_EN1 | RTN_RST1 | RTN_BEH1<1:0> |       |
| bit 7   |          |               |       |         |          | bit 0         |       |

### Legend:

|                   |                  |                       |
|-------------------|------------------|-----------------------|
| R = Readable bit  | W = Writable bit | U = Unimplemented bit |
| -n = Value at POR | '1' = Bit is set | '0' = Bit is cleared  |
|                   |                  | x = Bit is unknown    |

- bit 7      **RTN\_EN2:** Charge Ration Enable Port 2 - Enables Charge Rationing for Port 2.  
 1 = Charge Rationing enabled  
 0 = Charge Rationing disabled. The Total Accumulated Charge registers for Port 2 will be cleared to 00\_00h and current data will no longer be accumulated. If the Total Accumulated Charge registers have already reached the Charge Rationing Threshold, the applied response will be removed as if the charge rationing had been reset. This will also clear the RATION2 status bit (if set).
- bit 6      **RTN\_RST2:** Port 2 Ration Reset - Resets the charge rationing functionality for Port 2.  
 1 = Total Accumulated Charge registers are reset to 00\_00h. In addition, when this bit is set, the RATION2 status bit will be cleared and, if there are no other errors or active indicators, the ALERT#2 pin will be released.  
 0 = Normal operation. This bit must be cleared to enable charge rationing
- bit 5-4    **RTN\_BEH2<1:0>:** Ration Behavior Control bits - Controls how the UCS2113 responds when the Ration Threshold has been exceeded (as shown in [Table 6-2](#)).  
 00 = Report  
 01 = Report and Disconnect  
 10 = Disconnect and SLEEP  
 11 = Ignore
- bit 3      **RTN\_EN1:** Charge Ration Enable Port 1 - Enables Charge Rationing for Port 1.  
 1 = Charge Rationing enabled  
 0 = Charge Rationing disabled. The Total Accumulated Charge registers for Port 1 will be cleared to 00\_00h and current data will no longer be accumulated. If the Total Accumulated Charge registers have already reached the Charge Rationing Threshold, the applied response will be removed as if the charge rationing had been reset. This will also clear the RATION1 status bit (if set).
- bit 2      **RTN\_RST1:** Port 1 Ration Reset - Resets the charge rationing functionality for Port 1.  
 1 = Total Accumulated Charge registers are reset to 00\_00h. In addition, when this bit is set, the RATION1 status bit will be cleared and, if there are no other errors or active indicators, the ALERT#1 pin will be released.  
 0 = Normal operation. This bit must be cleared to enable charge rationing.
- bit 1-0    **RTN\_BEH1<1:0>:** Ration Behavior Control bits - Controls how the UCS2113 responds when the Ration Threshold has been exceeded (as shown in [Table 6-2](#)).  
 00 = Report  
 01 = Report and Disconnect  
 10 = Disconnect and SLEEP  
 11 = Ignore

# UCS2113

## 8.8 Current Limit Behavior Registers

The Current Limit Behavior register stores the values used by the applied current limiting mode (Trip or CC). The contents of this register are not retained in Sleep.

### REGISTER 8-17: PORT 1 CURRENT LIMIT BEHAVIOR REGISTER (ADDRESS 23H)

| R/W-1              | R/W-0 | R/W-0        | R/W-1             | R/W-0 | R/W-1    | R/W-1    | R/W-0 |
|--------------------|-------|--------------|-------------------|-------|----------|----------|-------|
| SEL_VBUS1_MIN<1:0> |       | DISCHG_LOAD1 | SEL_R2_IMIN1<2:0> |       | Reserved | Reserved |       |
| bit 7              |       |              |                   |       |          |          | bit 0 |

#### Legend:

R = Readable bit                      W = Writable bit                      U = Unimplemented bit  
-n = Value at POR                      '1' = Bit is set                      '0' = Bit is cleared                      x = Bit is unknown

bit 7-6      **SEL\_VBUS1\_MIN<1:0>**: Define the  $V_{BUS\_MIN}$  voltage for Port 1 as follows:

00 = 1.50V  
01 = 1.75V  
10 = 2.0V  
11 = 2.25V

bit 5      **DISCHG\_LOAD1**: Connects the internal 100Ω load to discharge  $V_{BUS1}$  (Note 1). The SMBus host must set this bit to discharge  $V_{BUS1}$  if the EN\_VBUS\_DISCHG bit from the General Configuration 2 register 12h is '0'. This functionality doesn't use any timer. The discharge time is controlled by the SMBus host, which must clear this bit when its internal timer expires. The difference from DISCHG1 bit from the General Configuration 1 register 11h is that, when that bit is set, the discharge time is controlled by the UCS2113 internal timer.

The state of this bit is ignored when the EN\_VBUS\_DISCHG bit from the General Configuration 2 register 12h is '1'.

bit 4-2      **SEL\_R2\_IMIN1<2:0>**: Defines the  $I_{BUS\_R2MIN}$  current

000 = 100 mA  
001 = 530 mA  
010 = 960 mA  
011 = 1280 mA  
100 = 1600 mA  
101 = 2130 mA

bit 1-0      **Reserved**: Do not change

**Note 1:** If the corresponding power switch is still turned on (PWR\_EN1 control is active) while DISCHG\_LOAD1 bit is set, the internal 100Ω load will be connected in parallel with the load on the VBUS1 pins.

### REGISTER 8-18: PORT 2 CURRENT LIMIT BEHAVIOR REGISTER (ADDRESS 24H)

| R/W-1              | R/W-0 | R/W-0        | R/W-1                 | R/W-0 | R/W-1    | R/W-1    | R/W-0 |
|--------------------|-------|--------------|-----------------------|-------|----------|----------|-------|
| SEL_VBUS2_MIN<1:0> |       | DISCHG_LOAD2 | SEL_R2_IMIN2_MIN<2:0> |       | Reserved | Reserved |       |
| bit 7              |       |              |                       |       |          |          | bit 0 |

#### Legend:

R = Readable bit                      W = Writable bit                      U = Unimplemented bit  
-n = Value at POR                      '1' = Bit is set                      '0' = Bit is cleared                      x = Bit is unknown

bit 7-6      **SEL\_VBUS2\_MIN<1:0>**: Define the  $V_{BUS\_MIN}$  voltage for Port 2 as follows:

00 = 1.50V  
01 = 1.75V  
10 = 2.0V  
11 = 2.25V

## REGISTER 8-18: PORT 2 CURRENT LIMIT BEHAVIOR REGISTER (ADDRESS 24H) (CONTINUED)

bit 5 **DISCHG\_LOAD2**: Connects the internal 100Ω load to discharge  $V_{BUS2}$  (Note 1). The SMBus host must set this bit to discharge  $V_{BUS2}$  if the EN\_VBUS\_DISCHG bit from the General Configuration 2 register 12h is '0'. This functionality doesn't use any timer. The discharge time is controlled by the SMBus host, which must clear this bit when its internal timer expires. The difference from DSCHG2 bit from the General Configuration 2 register 12h is that, when that bit is set, the discharge time is controlled by the UCS2113 internal timer.

The state of this bit is ignored when the EN\_VBUS\_DISCHG bit from the General Configuration 2 register 12h is '1'.

bit 4-2 **SEL\_R2\_IMIN2\_MIN<2:0>**: Defines the  $I_{BUS\_R2MIN}$  current

000 =100 mA  
 001 =530 mA  
 010 =960 mA  
 011 =1280 mA  
 100 =1600 mA  
 101 =2130 mA

bit 1-0 **Reserved**: Do not change

**Note 1:** If the corresponding power switch is still turned on (PWR\_EN2 control is active) while DISCHG\_LOAD2 bit is set, the internal 100Ω load will be connected in parallel with the load on the VBUS2 pins.

## 8.9 Product ID Register

The Product ID register stores a unique 8-bit value that identifies the UCS device family.

### REGISTER 8-19: PRODUCT ID REGISTER (ADDRESS FDH)

|          |     |     |     |     |     |       |     |
|----------|-----|-----|-----|-----|-----|-------|-----|
| R-1      | R-1 | R-1 | R-0 | R-0 | R-0 | R-1   | R-0 |
| PID<7:0> |     |     |     |     |     |       |     |
| bit 7    |     |     |     |     |     | bit 0 |     |

#### Legend:

R = Readable bit                      W = Writable bit                      U = Unimplemented bit  
 -n = Value at POR                      '1' = Bit is set                      '0' = Bit is cleared                      x = Bit is unknown

bit 7-0 **PID<7:0>**: Product ID for the UCS2113

## 8.10 Manufacture ID Register

The Manufacturer ID register stores a unique 8-bit value that identifies Microchip Technology Inc.

### REGISTER 8-20: MANUFACTURER ID REGISTER (ADDRESS FEH)

|          |     |     |     |     |     |       |     |
|----------|-----|-----|-----|-----|-----|-------|-----|
| R-0      | R-1 | R-0 | R-1 | R-1 | R-1 | R-0   | R-1 |
| MID<7:0> |     |     |     |     |     |       |     |
| bit 7    |     |     |     |     |     | bit 0 |     |

#### Legend:

R = Readable bit                      W = Writable bit                      U = Unimplemented bit  
 -n = Value at POR                      '1' = Bit is set                      '0' = Bit is cleared                      x = Bit is unknown

bit 7-0 **MID<7:0>**: Manufacturer ID for Microchip

# UCS2113

---

## 8.11 Revision Register

The Revision register stores an 8-bit value that represents the part revision.

### REGISTER 8-21: REVISION REGISTER (ADDRESS FFH)

|          |     |     |     |       |     |     |     |
|----------|-----|-----|-----|-------|-----|-----|-----|
| R-1      | R-0 | R-0 | R-0 | R-0   | R-0 | R-0 | R-1 |
| REV<7:0> |     |     |     |       |     |     |     |
| bit 7    |     |     |     | bit 0 |     |     |     |

**Legend:**

R = Readable bit

W = Writable bit

U = Unimplemented bit

-n = Value at POR

'1' = Bit is set

'0' = Bit is cleared

x = Bit is unknown

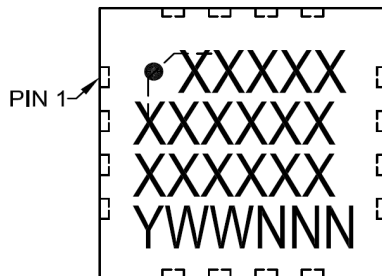
bit 7-0

**REV<7:0>**: Part Revision

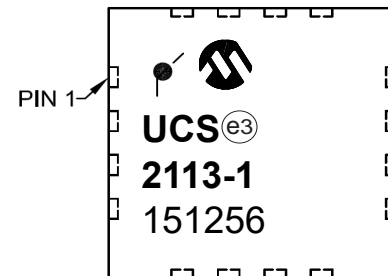
## 9.0 PACKAGING INFORMATION

### 9.1 Package Marking Information

20-Lead QFN (4x4x0.9 mm)



Example



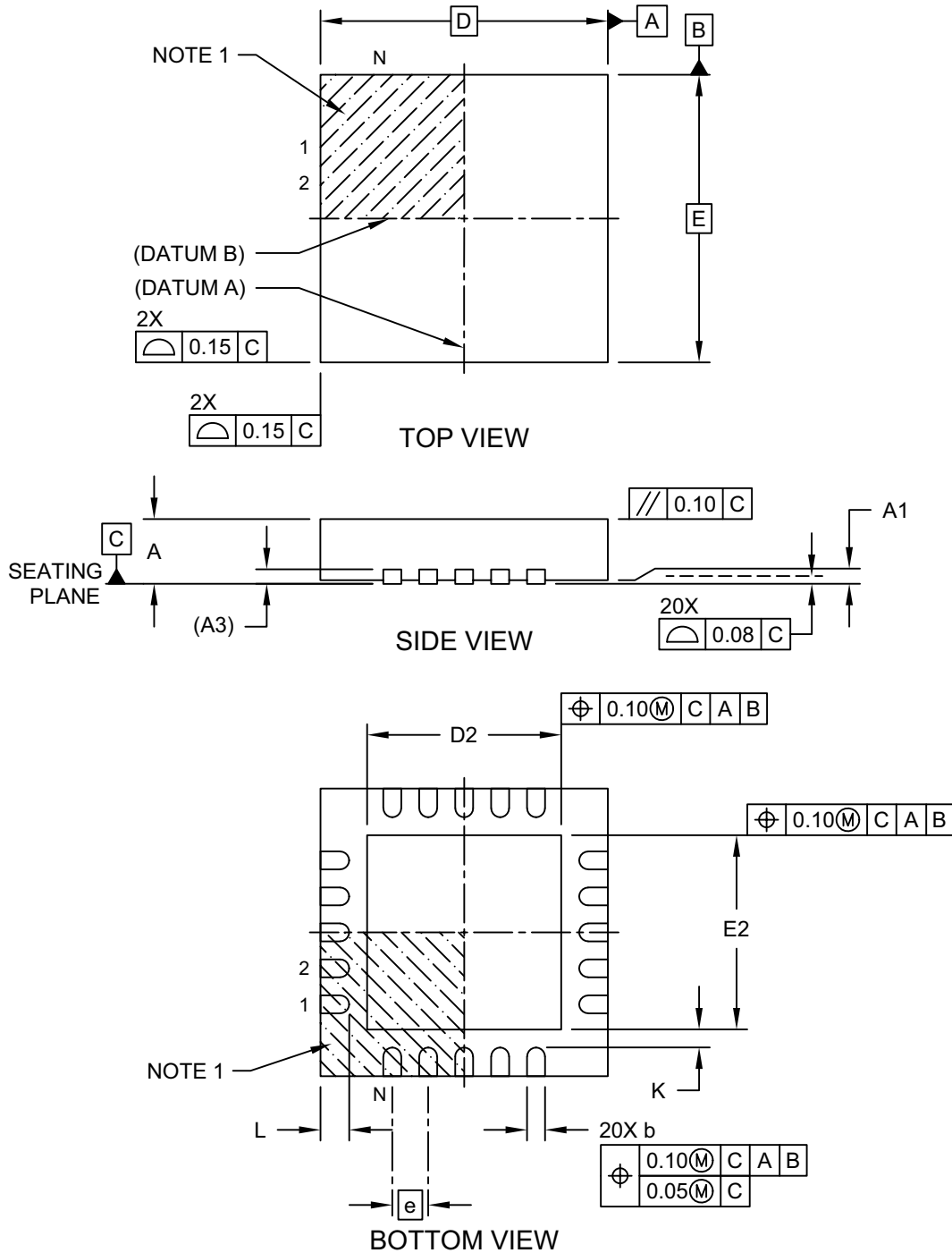
|                |        |  |
|----------------|--------|--|
| <b>Legend:</b> | XX...X | Customer-specific information  |
|                | Y      | Year code (last digit of calendar year)  |
|                | YY     | Year code (last 2 digits of calendar year)   |
|                | WW     | Week code (week of January 1 is week '01')   |
|                | NNN    | Alphanumeric traceability code   |
|                | (e3)   | Pb-free JEDEC® designator for Matte Tin (Sn)   |
|                | *      | This package is Pb-free. The Pb-free JEDEC designator (e3) can be found on the outer packaging for this package. |

**Note:** In the event the full Microchip part number cannot be marked on one line, it will be carried over to the next line, thus limiting the number of available characters for customer-specific information.

# UCS2113

## 20-Lead Plastic Quad Flat, No Lead Package (G4) - 4x4 mm Body [QFN] Also called VQFN

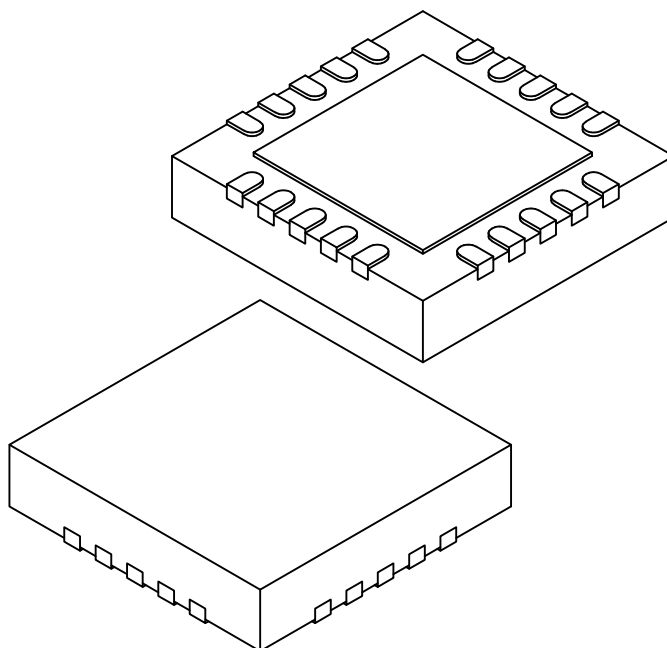
**Note:** For the most current package drawings, please see the Microchip Packaging Specification located at <http://www.microchip.com/packaging>



Microchip Technology Drawing C04-126-G4 Rev D Sheet 1 of 2

## 20-Lead Plastic Quad Flat, No Lead Package (G4) - 4x4 mm Body [QFN] Also called VQFN

**Note:** For the most current package drawings, please see the Microchip Packaging Specification located at <http://www.microchip.com/packaging>



| Dimension Limits        | Units | MILLIMETERS |      |      |
|-------------------------|-------|-------------|------|------|
|                         |       | MIN         | NOM  | MAX  |
| Number of Terminals     | N     | 20          |      |      |
| Pitch                   | e     | 0.50 BSC    |      |      |
| Overall Height          | A     | 0.80        | 0.90 | 1.00 |
| Standoff                | A1    | 0.00        | 0.02 | 0.05 |
| Terminal Thickness      | A3    | 0.20 REF    |      |      |
| Overall Length          | D     | 4.00 BSC    |      |      |
| Exposed Pad Length      | D2    | 2.60        | 2.70 | 2.80 |
| Overall Width           | E     | 4.00 BSC    |      |      |
| Exposed Pad Width       | E2    | 2.60        | 2.70 | 2.80 |
| Terminal Width          | b     | 0.18        | 0.25 | 0.30 |
| Terminal Length         | L     | 0.30        | 0.40 | 0.50 |
| Terminal-to-Exposed-Pad | K     | 0.20        | -    | -    |

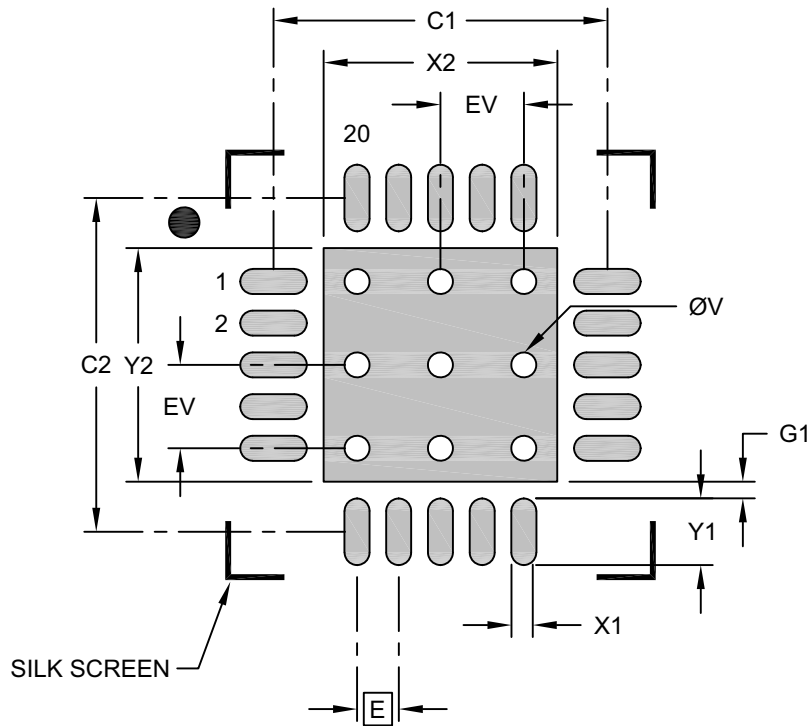
**Notes:**

1. Pin 1 visual index feature may vary, but must be located within the hatched area.
2. Package is saw singulated
3. Dimensioning and tolerancing per ASME Y14.5M
  - BSC: Basic Dimension. Theoretically exact value shown without tolerances.
  - REF: Reference Dimension, usually without tolerance, for information purposes only.

Microchip Technology Drawing C04-126-G4 Rev D Sheet 2 of 2

## 20-Lead Plastic Quad Flat, No Lead Package (G4) - 4x4 mm Body [QFN] Also called VQFN

**Note:** For the most current package drawings, please see the Microchip Packaging Specification located at <http://www.microchip.com/packaging>



**RECOMMENDED LAND PATTERN**

| Dimension Limits                | Units | MILLIMETERS |      |      |
|---------------------------------|-------|-------------|------|------|
|                                 |       | MIN         | NOM  | MAX  |
| Contact Pitch                   | E     | 0.50 BSC    |      |      |
| Optional Center Pad Width       | X2    |             |      | 2.80 |
| Optional Center Pad Length      | Y2    |             |      | 2.80 |
| Contact Pad Spacing             | C1    |             | 4.00 |      |
| Contact Pad Spacing             | C2    |             | 4.00 |      |
| Contact Pad Width (X20)         | X1    |             |      | 0.30 |
| Contact Pad Length (X20)        | Y1    |             |      | 0.80 |
| Contact Pad to Center Pad (X16) | G1    | 0.20        |      |      |
| Thermal Via Diameter            | V     |             | 0.30 |      |
| Thermal Via Pitch               | EV    |             | 1.00 |      |

**Notes:**

1. Dimensioning and tolerancing per ASME Y14.5M  
BSC: Basic Dimension. Theoretically exact value shown without tolerances.
2. For best soldering results, thermal vias, if used, should be filled or tented to avoid solder loss during reflow process

Microchip Technology Drawing C04-2126-G4 Rev D



## APPENDIX A: REVISION HISTORY

### Revision B (December 2021)

- Added automotive qualification to [Features](#).
- Updated document layout.
- Updated markings and drawings in [Section 9.0 “Packaging Information”](#).
- Updated [Product Identification System](#) to include automotive information and examples.

### Revision A (December 2016)

- Original release of this document.

# UCS2113

---

NOTES:

## PRODUCT IDENTIFICATION SYSTEM

To order or obtain information, e.g., on pricing or delivery, refer to the factory or the listed sales office.

| <b>PART NO.</b>              | <b>[I]<sup>(1)</sup></b> | <b>=X</b>   | <b>=X</b>                | <b>/XX</b>     | <b>XXX</b>           | <b>Examples:</b> |   |
|------------------------------|--------------------------|---|--------------------------|----------------|----------------------|------------------|---|
| <b>Device</b>                | <b>Tape and Reel</b>     | <b>Version</b>  | <b>Temperature Range</b> | <b>Package</b> | <b>Qualification</b> |                  |   |
| <b>Device:</b>               | UCS2113:                 | USB Dual-Port Power Switch and Current Monitor  |                          |                |                      |                  | a) UCS2113-1-V/G4: Tube or Tray, SMBus Address 57h, Various Temperature, 20-pin 4x4 QFN Package   |
| <b>Tape and Reel Option:</b> | <Blank><br>T             | = Standard packaging (tube or tray)<br>= Tape and Reel <sup>(1)</sup>                                       |                          |                |                      |                  | b) UCS2113T-1-V/G4: Tape and Reel, SMBus Address 57h, Various Temperature, 20-pin 4x4 QFN Package   |
| <b>Version:</b>              | 1<br>2                   | = SMBus address 57h<br>= SMBus address 56h  |                          |                |                      |                  | c) UCS2113-2-V/G4: Tube or Tray, SMBus Address 56h, Various Temperature, 20-pin 4x4 QFN Package   |
| <b>Temperature Range:</b>    | V                        | = -40°C to +105°C (Various)   |                          |                |                      |                  | d) UCS2113T-2-V/G4: Tape and Reel, SMBus Address 56h, Various Temperature, 20-pin 4x4 QFN Package   |
| <b>Package:</b>              | G4                       | = Plastic Quad Flat No Lead Package - 4x4 mm Body with 0.40 mm Contact Length, Saw Singulated, QFN, 20-lead |                          |                |                      |                  | e) UCS2113T-1-V/G4VAO: Tape and Reel, SMBus Address 57h, Various Temperature, 20-pin 4x4 QFN Package, Automotive Qualified  |
| <b>Qualification:</b>        | <Blank><br>VAO           | = Standard Part<br>= Automotive AEC-Q100 Qualified  |                          |                |                      |                  | <b>Note 1:</b> Tape and Reel identifier only appears in the catalog part number description. This identifier is used for ordering purposes and is not printed on the device package. Check with your Microchip Sales Office for package availability with the Tape and Reel option. |

# UCS2113

---

NOTES:

---

---

**Note the following details of the code protection feature on Microchip products:**

- Microchip products meet the specifications contained in their particular Microchip Data Sheet.
- Microchip believes that its family of products is secure when used in the intended manner, within operating specifications, and under normal conditions.
- Microchip values and aggressively protects its intellectual property rights. Attempts to breach the code protection features of Microchip product is strictly prohibited and may violate the Digital Millennium Copyright Act.
- Neither Microchip nor any other semiconductor manufacturer can guarantee the security of its code. Code protection does not mean that we are guaranteeing the product is “unbreakable”. Code protection is constantly evolving. Microchip is committed to continuously improving the code protection features of our products.

---

This publication and the information herein may be used only with Microchip products, including to design, test, and integrate Microchip products with your application. Use of this information in any other manner violates these terms. Information regarding device applications is provided only for your convenience and may be superseded by updates. It is your responsibility to ensure that your application meets with your specifications. Contact your local Microchip sales office for additional support or, obtain additional support at <https://www.microchip.com/en-us/support/design-help/client-support-services>.

THIS INFORMATION IS PROVIDED BY MICROCHIP "AS IS". MICROCHIP MAKES NO REPRESENTATIONS OR WARRANTIES OF ANY KIND WHETHER EXPRESS OR IMPLIED, WRITTEN OR ORAL, STATUTORY OR OTHERWISE, RELATED TO THE INFORMATION INCLUDING BUT NOT LIMITED TO ANY IMPLIED WARRANTIES OF NON-INFRINGEMENT, MERCHANTABILITY, AND FITNESS FOR A PARTICULAR PURPOSE, OR WARRANTIES RELATED TO ITS CONDITION, QUALITY, OR PERFORMANCE.

IN NO EVENT WILL MICROCHIP BE LIABLE FOR ANY INDIRECT, SPECIAL, PUNITIVE, INCIDENTAL, OR CONSEQUENTIAL LOSS, DAMAGE, COST, OR EXPENSE OF ANY KIND WHATSOEVER RELATED TO THE INFORMATION OR ITS USE, HOWEVER CAUSED, EVEN IF MICROCHIP HAS BEEN ADVISED OF THE POSSIBILITY OR THE DAMAGES ARE FORESEEABLE. TO THE FULLEST EXTENT ALLOWED BY LAW, MICROCHIP'S TOTAL LIABILITY ON ALL CLAIMS IN ANY WAY RELATED TO THE INFORMATION OR ITS USE WILL NOT EXCEED THE AMOUNT OF FEES, IF ANY, THAT YOU HAVE PAID DIRECTLY TO MICROCHIP FOR THE INFORMATION.

Use of Microchip devices in life support and/or safety applications is entirely at the buyer's risk, and the buyer agrees to defend, indemnify and hold harmless Microchip from any and all damages, claims, suits, or expenses resulting from such use. No licenses are conveyed, implicitly or otherwise, under any Microchip intellectual property rights unless otherwise stated.

For information regarding Microchip's Quality Management Systems, please visit [www.microchip.com/quality](http://www.microchip.com/quality).

**Trademarks**

The Microchip name and logo, the Microchip logo, Adaptec, AnyRate, AVR, AVR logo, AVR Freaks, BesTime, BitCloud, CryptoMemory, CryptoRF, dsPIC, flexPWR, HELDO, IGLOO, JukeBlox, KeeLoq, Kleer, LANCheck, LinkMD, maXStylus, maXTouch, MediaLB, megaAVR, Microsemi, Microsemi logo, MOST, MOST logo, MPLAB, OptoLyzr, PIC, picoPower, PICSTART, PIC32 logo, PolarFire, Prochip Designer, QTouch, SAM-BA, SenGenuity, SpyNIC, SST, SST Logo, SuperFlash, Symmetricom, SyncServer, Tachyon, TimeSource, tinyAVR, UNI/O, Vectron, and XMEGA are registered trademarks of Microchip Technology Incorporated in the U.S.A. and other countries.

AgileSwitch, APT, ClockWorks, The Embedded Control Solutions Company, EtherSynch, Flashtec, Hyper Speed Control, HyperLight Load, IntelliMOS, Libero, motorBench, mTouch, Powermite 3, Precision Edge, ProASIC, ProASIC Plus, ProASIC Plus logo, QuietWire, SmartFusion, SyncWorld, Temux, TimeCesium, TimeHub, TimePictra, TimeProvider, TrueTime, WinPath, and ZL are registered trademarks of Microchip Technology Incorporated in the U.S.A.

Adjacent Key Suppression, AKS, Analog-for-the-Digital Age, Any Capacitor, AnyIn, AnyOut, Augmented Switching, BlueSky, BodyCom, CodeGuard, CryptoAuthentication, CryptoAutomotive, CryptoCompanion, CryptoController, dsPICDEM, dsPICDEM.net, Dynamic Average Matching, DAM, ECAN, Espresso T1S, EtherGREEN, GridTime, IdealBridge, In-Circuit Serial Programming, ICSP, INICnet, Intelligent Paralleling, Inter-Chip Connectivity, JitterBlocker, Knob-on-Display, maxCrypto, maxView, memBrain, Mindi, MiWi, MPASM, MPF, MPLAB Certified logo, MPLIB, MPLINK, MultiTRAK, NetDetach, NVM Express, NVMe, Omniscient Code Generation, PICDEM, PICDEM.net, PICKit, PICtail, PowerSmart, PureSilicon, QMatrix, REAL ICE, Ripple Blocker, RTAX, RTG4, SAM-ICE, Serial Quad I/O, simpleMAP, SimpliPHY, SmartBuffer, SmartHLS, SMART-I.S., storClad, SQL, SuperSwitcher, SuperSwitcher II, Switchtec, SynchroPHY, Total Endurance, TSHARC, USBCheck, VariSense, VectorBlox, VeriPHY, ViewSpan, WiperLock, XpressConnect, and ZENA are trademarks of Microchip Technology Incorporated in the U.S.A. and other countries.

SQTP is a service mark of Microchip Technology Incorporated in the U.S.A.

The Adaptec logo, Frequency on Demand, Silicon Storage Technology, Symmcom, and Trusted Time are registered trademarks of Microchip Technology Inc. in other countries.

GestIC is a registered trademark of Microchip Technology Germany II GmbH & Co. KG, a subsidiary of Microchip Technology Inc., in other countries.

All other trademarks mentioned herein are property of their respective companies.

© 2016-2021, Microchip Technology Incorporated and its subsidiaries.

All Rights Reserved.

ISBN: 978-1-5224-9358-7



# MICROCHIP

## Worldwide Sales and Service

### AMERICAS

**Corporate Office**  
2355 West Chandler Blvd.  
Chandler, AZ 85224-6199  
Tel: 480-792-7200  
Fax: 480-792-7277  
Technical Support:  
<http://www.microchip.com/support>  
Web Address:  
[www.microchip.com](http://www.microchip.com)

#### Atlanta

Duluth, GA  
Tel: 678-957-9614  
Fax: 678-957-1455

#### Austin, TX

Tel: 512-257-3370

#### Boston

Westborough, MA  
Tel: 774-760-0087  
Fax: 774-760-0088

#### Chicago

Itasca, IL  
Tel: 630-285-0071  
Fax: 630-285-0075

#### Dallas

Addison, TX  
Tel: 972-818-7423  
Fax: 972-818-2924

#### Detroit

Novi, MI  
Tel: 248-848-4000

#### Houston, TX

Tel: 281-894-5983

#### Indianapolis

Noblesville, IN  
Tel: 317-773-8323  
Fax: 317-773-5453  
Tel: 317-536-2380

#### Los Angeles

Mission Viejo, CA  
Tel: 949-462-9523  
Fax: 949-462-9608  
Tel: 951-273-7800

#### Raleigh, NC

Tel: 919-844-7510

#### New York, NY

Tel: 631-435-6000

#### San Jose, CA

Tel: 408-735-9110  
Tel: 408-436-4270

#### Canada - Toronto

Tel: 905-695-1980  
Fax: 905-695-2078

### ASIA/PACIFIC

**Australia - Sydney**  
Tel: 61-2-9868-6733

**China - Beijing**  
Tel: 86-10-8569-7000

**China - Chengdu**  
Tel: 86-28-8665-5511

**China - Chongqing**  
Tel: 86-23-8980-9588

**China - Dongguan**  
Tel: 86-769-8702-9880

**China - Guangzhou**  
Tel: 86-20-8755-8029

**China - Hangzhou**  
Tel: 86-571-8792-8115

**China - Hong Kong SAR**  
Tel: 852-2943-5100

**China - Nanjing**  
Tel: 86-25-8473-2460

**China - Qingdao**  
Tel: 86-532-8502-7355

**China - Shanghai**  
Tel: 86-21-3326-8000

**China - Shenyang**  
Tel: 86-24-2334-2829

**China - Shenzhen**  
Tel: 86-755-8864-2200

**China - Suzhou**  
Tel: 86-186-6233-1526

**China - Wuhan**  
Tel: 86-27-5980-5300

**China - Xian**  
Tel: 86-29-8833-7252

**China - Xiamen**  
Tel: 86-592-2388138

**China - Zhuhai**  
Tel: 86-756-3210040

### ASIA/PACIFIC

**India - Bangalore**  
Tel: 91-80-3090-4444

**India - New Delhi**  
Tel: 91-11-4160-8631

**India - Pune**  
Tel: 91-20-4121-0141

**Japan - Osaka**  
Tel: 81-6-6152-7160

**Japan - Tokyo**  
Tel: 81-3-6880-3770

**Korea - Daegu**  
Tel: 82-53-744-4301

**Korea - Seoul**  
Tel: 82-2-554-7200

**Malaysia - Kuala Lumpur**  
Tel: 60-3-7651-7906

**Malaysia - Penang**  
Tel: 60-4-227-8870

**Philippines - Manila**  
Tel: 63-2-634-9065

**Singapore**  
Tel: 65-6334-8870

**Taiwan - Hsin Chu**  
Tel: 886-3-577-8366

**Taiwan - Kaohsiung**  
Tel: 886-7-213-7830

**Taiwan - Taipei**  
Tel: 886-2-2508-8600

**Thailand - Bangkok**  
Tel: 66-2-694-1351

**Vietnam - Ho Chi Minh**  
Tel: 84-28-5448-2100

### EUROPE

**Austria - Wels**  
Tel: 43-7242-2244-39  
Fax: 43-7242-2244-393

**Denmark - Copenhagen**  
Tel: 45-4485-5910  
Fax: 45-4485-2829

**Finland - Espoo**  
Tel: 358-9-4520-820

**France - Paris**  
Tel: 33-1-69-53-63-20  
Fax: 33-1-69-30-90-79

**Germany - Garching**  
Tel: 49-8931-9700

**Germany - Haan**  
Tel: 49-2129-3766400

**Germany - Heilbronn**  
Tel: 49-7131-72400

**Germany - Karlsruhe**  
Tel: 49-721-625370

**Germany - Munich**  
Tel: 49-89-627-144-0  
Fax: 49-89-627-144-44

**Germany - Rosenheim**  
Tel: 49-8031-354-560

**Israel - Ra'anana**  
Tel: 972-9-744-7705

**Italy - Milan**  
Tel: 39-0331-742611  
Fax: 39-0331-466781

**Italy - Padova**  
Tel: 39-049-7625286

**Netherlands - Drunen**  
Tel: 31-416-690399  
Fax: 31-416-690340

**Norway - Trondheim**  
Tel: 47-7288-4388

**Poland - Warsaw**  
Tel: 48-22-3325737

**Romania - Bucharest**  
Tel: 40-21-407-87-50

**Spain - Madrid**  
Tel: 34-91-708-08-90  
Fax: 34-91-708-08-91

**Sweden - Gothenberg**  
Tel: 46-31-704-60-40

**Sweden - Stockholm**  
Tel: 46-8-5090-4654

**UK - Wokingham**  
Tel: 44-118-921-5800  
Fax: 44-118-921-5820