

- Qualified for Automotive Applications
- ESD Protection Exceeds 200 V Using Machine Model (C = 200 pF, R = 0)
- 100- $\mu$ A Typical Starting Supply Current
- 500- $\mu$ A Typical Operating Supply Current
- Operation to 1 MHz
- Internal Soft Start
- Internal Fault Soft Start
- Internal Leading-Edge Blanking of the Current Sense Signal
- 1-Amp Totem-Pole Output
- 70-ns Typical Response from Current-Sense to Gate Drive Output
- 1.5% Tolerance Voltage Reference
- Same Pinout as UC3842 and UC3842A

## description

The UCC2800/1/2/3/4/5 family of high-speed, low-power integrated circuits contain all of the control and drive components required for off-line and dc-to-dc fixed frequency current-mode switching power supplies with minimal parts count.

These devices have the same pin configuration as the UC2842/3/4/5 family and also offer the added features of internal full-cycle soft start and internal leading-edge blanking of the current-sense input.

The UCC2800/1/2/3/4/5 family offers choice of maximum duty cycle and critical voltage levels. Lower reference parts such as the UCC2803 and UCC2805 fit best into battery operated systems, while the higher reference and the higher UVLO hysteresis of the UCC2802 and UCC2804 make these ideal choices for use in off-line power supplies.

The UCC280xQDRQ1 series is specified for the automotive temperature range of  $-40^{\circ}\text{C}$  to  $125^{\circ}\text{C}$ , and qualified in accordance with AEC-Q100 stress test qualification for integrated circuits.

PART NUMBER	MAXIMUM DUTY CYCLE	REFERENCE VOLTAGE	TURN-ON THRESHOLD	TURN-OFF THRESHOLD
UCC2800	100%	5 V	7.2 V	6.9 V
UCC2801	50%	5 V	9.4 V	7.4 V
UCC2802	100%	5 V	12.5 V	8.3 V
UCC2803	100%	4 V	4.1 V	3.6 V
UCC2804	50%	5 V	12.5 V	8.3 V
UCC2805	50%	4 V	4.1 V	3.6 V



Please be aware that an important notice concerning availability, standard warranty, and use in critical applications of Texas Instruments semiconductor products and disclaimers thereto appears at the end of this data sheet.

PRODUCTION DATA information is current as of publication date. Products conform to specifications per the terms of Texas Instruments standard warranty. Production processing does not necessarily include testing of all parameters.



POST OFFICE BOX 655303 • DALLAS, TEXAS 75265

Copyright © 2008, Texas Instruments Incorporated

# UCC2800/2801/2802/2803/2804/2805-Q1

## LOW-POWER BICMOS CURRENT-MODE PWM

SGLS121C – JULY 2002 – REVISED APRIL 2008

### block diagram

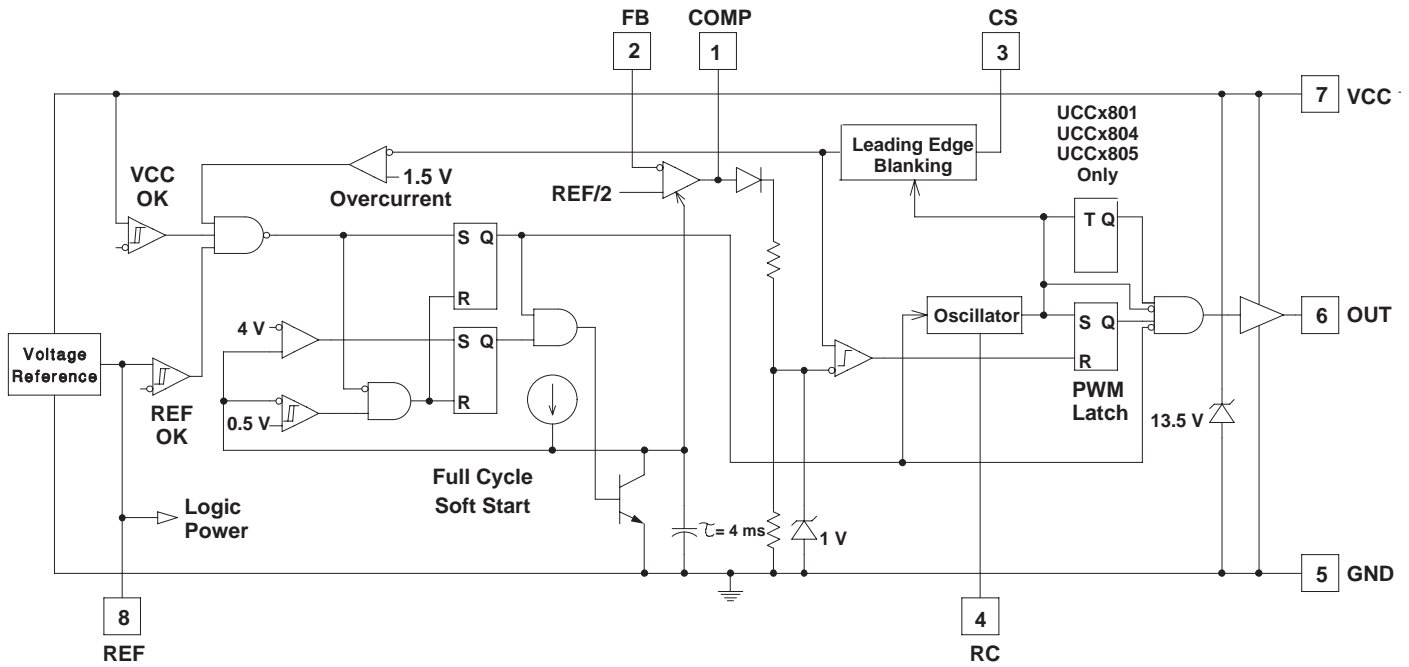

#### AVAILABLE OPTIONS†

TA	SOIC-8 SMALL OUTLINE‡ (D)
-40°C to 125°C	UCC2800QDRQ1§
	UCC2801QDRQ1§
	UCC2802QDRQ1§
	UCC2803QDRQ1§
	UCC2804QDRQ1§
	UCC2805QDRQ1§

† For the most current package and ordering information, see the Package Option Addendum at the end of this document, or see the TI web site at <http://www.ti.com>.

‡ Package drawings, thermal data, and symbolization are available at <http://www.ti.com/packaging>.

§ The UCC280x-Q1 is only available taped and reeled in quantities of 2500 devices per reel.

#### D PACKAGE (TOP VIEW)

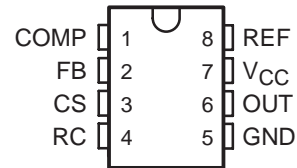

# UCC2800/2801/2802/2803/2804/2805-Q1 LOW-POWER BICMOS CURRENT-MODE PWM

SGLS121C – JULY 2002 – REVISED APRIL 2008

## Ordering Information

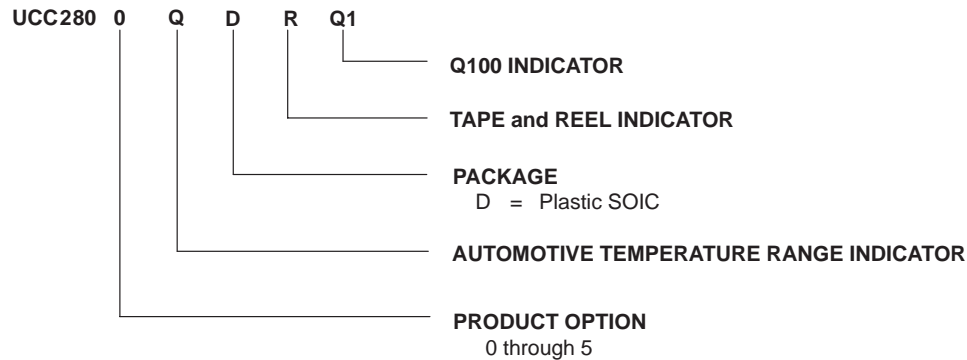

### absolute maximum ratings over operating free-air temperature range (unless otherwise noted)<sup>†‡</sup>

V <sub>CC</sub> voltage §	12 V
V <sub>CC</sub> current §	30 mA
Output current, I <sub>O</sub>	±1 A
Output energy, (Capacitive Load)	20 μJ
Analog Inputs (FB, CS)	–0.3 V to 6.3 V
Power Dissipation at T <sub>A</sub> < +25°C (D package)	0.65 W
Storage temperature range, T <sub>stg</sub>	–65°C to 150°C
Lead temperature soldering 1,6 mm (1/16 inch) from case for 10 seconds	300°C

<sup>†</sup> Stresses beyond those listed under “absolute maximum ratings” may cause permanent damage to the device. These are stress ratings only, and functional operation of the device at these or any other conditions beyond those indicated under “recommended operating conditions” is not implied. Exposure to absolute-maximum-rated conditions for extended periods may affect device reliability.

<sup>‡</sup> Unless otherwise indicated, voltages are reference to ground and currents are positive into and negative out of the specified terminals.

§ In normal operation V<sub>CC</sub> is powered through a current limiting resistor. Absolute maximum of 12 V applies when V<sub>CC</sub> is driven from a low impedance source such that I<sub>CC</sub> does not exceed 30 mA (which includes gate drive current requirement).

### electrical characteristics T<sub>A</sub> = –40°C to 125°C, V<sub>CC</sub> = 10 V (see Note 1), R<sub>T</sub> = 100 kΩ from REF to RC, C<sub>T</sub> = 330 pF from RC to GND, 0.1-F capacitor from V<sub>CC</sub> to GND, 0.1-F capacitor from V<sub>REF</sub> to GND and T<sub>A</sub> = T<sub>J</sub> (unless otherwise stated)

PARAMETER	TEST CONDITIONS	MIN	TYP	MAX	UNITS	
<b>Reference Section</b>						
Output voltage	T <sub>J</sub> = 25°C, I = 0.2 mA	UCC2800/01/02/04	4.925	5	5.075	V
		UCC2803/05	3.94	4	4.06	
Load regulation voltage	I = 0.2 mA to 5 mA		10	30	mV	
Line regulation voltage	V <sub>CC</sub> = 10 V to 12 V	T <sub>J</sub> = 25°C			1.9	mV/V
		T <sub>J</sub> = –40°C to 125°C			2.5	
Total variation voltage	See Note 5	UCC2800/01/02/04	4.88	5	5.1	V
		UCC2803/05	3.9	4	4.08	
Output noise voltage	f = 10 Hz to 10 kHz, See Note 7		130		μV	
Long term stability	1000 hours, See Note 7		5		mV	
Output short-circuit current		–5		–35	mA	



# UCC2800/2801/2802/2803/2804/2805-Q1

## LOW-POWER BICMOS CURRENT-MODE PWM

SGLS121C – JULY 2002 – REVISED APRIL 2008

electrical characteristics  $T_A = -40^\circ\text{C}$  to  $125^\circ\text{C}$ ,  $V_{CC} = 10\text{ V}$  (see Note 1),  $R_T = 100\text{ k}\Omega$  from REF to RC,  $C_T = 330\text{ pF}$  from RC to GND, 0.1-F capacitor from  $V_{CC}$  to GND, 0.1-F capacitor from  $V_{REF}$  to GND and  $T_A = T_J$  (unless otherwise stated)

PARAMETER	TEST CONDITIONS		MIN	TYP	MAX	UNITS	
<b>Oscillator Section</b>							
Oscillator frequency	See Note 2	UCC2800/01/02/04	40	46	52	kHz	
		UCC2803/05	26	31	36		
Temperature stability	See Note 7		2.5			%	
Amplitude peak-to-peak			2.25	2.4	2.55	V	
Oscillator peak voltage			2.45			V	
<b>Error Amplifier Section</b>							
Input voltage	COMP = 2.5 V	UCC2800/01/02/04	2.44	2.5	2.56	V	
	COMP = 2.0 V	UCC2803/05	1.95	2	2.05		
Input bias current			-1		1	$\mu\text{A}$	
Open loop voltage gain			60	80		db	
COMP sink current	FB = 2.7 V,	COMP = 1.1 V	0.3		3.5	mA	
COMP source current	FB = 1.8 V,	COMP = REF - 1.2 V	-0.2	-0.5	-0.8	mA	
Gain bandwidth product	See Note 7		2			MHz	
<b>PWM Section</b>							
Maximum duty cycle			UCC2800/02/03	97	99	100	%
			UCC2801/04/05	48	49	50	
Minimum duty cycle	COMP = 0 V					0	%
<b>Current Sense Section</b>							
Gain	See Note 3		1.1	1.65	1.8	V/V	
Maximum input signal	COMP = 5 V,	See Note 4	0.9	1	1.1	V	
Input bias current			-200		200	nA	
CS blank time			50	100	150	ns	
Over-current threshold voltage			1.42	1.55	1.68	V	
COMP to CS offset voltage	CS = 0 V		0.45	0.9	1.35	V	
<b>Output Section (OUT)</b>							
Low-level output voltage	$I_{OUT} = 20\text{ mA}$	All parts	0.1		0.4	V	
	$I_{OUT} = 200\text{ mA}$	All parts	0.35		0.9		
	$I_{OUT} = 50\text{ mA}$ , $V_{CC} = 5\text{ V}$	UCC2803/05	0.15		0.4		
	$I_{OUT} = 20\text{ mA}$ , $V_{CC} = 0\text{ V}$	All parts	0.7		1.2		
High-level output voltage $V_{SAT}$ ( $V_{CC} - OUT$ )	$I_{OUT} = -20\text{ mA}$	All parts	0.15		0.4	V	
	$I_{OUT} = -200\text{ mA}$	All parts	1		1.9		
	$I_{OUT} = -50\text{ mA}$ , $V_{CC} = 5\text{ V}$	UCC2803/05	0.4		0.9		
Rise time	$C_L = 1\text{ nF}$		41		70	ns	
Fall time	$C_L = 1\text{ nF}$		44		75	ns	



# UCC2800/2801/2802/2803/2804/2805-Q1

## LOW-POWER BICMOS CURRENT-MODE PWM

SGLS121C – JULY 2002 – REVISED APRIL 2008

electrical characteristics  $T_A = -40^\circ\text{C}$  to  $125^\circ\text{C}$ ,  $V_{CC} = 10\text{ V}$  (see Note 1),  $R_T = 100\text{ k}\Omega$  from REF to RC,  $C_T = 330\text{ pF}$  from RC to GND, 0.1-F capacitor from  $V_{CC}$  to GND, 0.1-F capacitor from  $V_{REF}$  to GND and  $T_A = T_J$  (unless otherwise stated)

PARAMETER	TEST CONDITIONS		MIN	TYP	MAX	UNITS
<b>Undervoltage Lockout Section</b>						
Start threshold	See Note 6	UCC2800	6.6	7.2	7.8	V
		UCC2801	8.6	9.4	10.2	
		UCC2802/04	11.5	12.5	13.5	
		UCC2803/05	3.7	4.1	4.5	
Stop threshold	See Note 6	UCC2800	6.3	6.9	7.5	V
		UCC2801	6.8	7.4	8	
		UCC2802/04	7.6	8.3	9	
		UCC2803/05	3.2	3.6	4	
Start to stop hysteresis		UCC2800	0.12	0.3	0.48	V
		UCC2801	1.6	2	2.4	
		UCC2802/04	3.5	4.2	5.1	
		UCC2803/05	0.2	0.5	0.8	
<b>Soft Start Section</b>						
COMP rise time	FB = 1.8 V,	Rise from 0.5 V to REF – 1 V		4	10	ms
<b>Overall Section</b>						
Start-up current	$V_{CC} < \text{Start Threshold}$			0.1	0.2	mA
Operating supply current	FB = 0 V,	CS = 0 V		0.5	1	mA
$V_{CC}$ internal zener voltage	$I_{CC} = 10\text{ mA}$ ,	See Notes 6 and 8	12	13.5	15	V
$V_{CC}$ internal zener voltage minus start threshold voltage	See Note 6	UCC2802/04	0.5	1.0		V

- NOTES:
- Adjust  $V_{CC}$  above the start threshold before setting at 10 V.
  - Oscillator frequency for the UCC2800, UCC2802 and UCC2803 is the output frequency.  
Oscillator frequency for the UCC2801, UCC2804 and UCC2805 is twice the output frequency.
  - Gain is defined by:  $A = \frac{\Delta V_{COMP}}{\Delta V_{CS}}$   $0 \leq V_{CS} \leq 0.8\text{ V}$ .
  - Parameter measured at trip point of latch with pin 2 at 0 V.
  - Total variation includes temperature stability and load regulation.
  - Start threshold, stop threshold, and zener shunt thresholds track one another.
  - Not production tested.
  - The device is fully operating in clamp mode as the forcing current is higher than the normal operating supply current.



# UCC2800/2801/2802/2803/2804/2805-Q1

## LOW-POWER BICMOS CURRENT-MODE PWM

SGLS121C – JULY 2002 – REVISED APRIL 2008

---

### detailed terminal descriptions

#### COMP

COMP is the output of the error amplifier and the input of the PWM comparator.

Unlike other devices, the error amplifier in the UCC2800 family is a true, low output-impedance, 2-MHz operational amplifier. As such, the COMP terminal can both source and sink current. However, the error amplifier is internally current limited, so that one can command zero duty cycle by externally forcing COMP to GND.

The UCC2800 family features built-in full cycle soft start. Soft start is implemented as a clamp on the maximum COMP voltage.

#### CS

CS is the input to the current sense comparators. The UCC2800 family has two different current sense comparators: the PWM comparator and an over-current comparator.

The UCC2800 family contains digital current sense filtering, which disconnects the CS terminal from the current sense comparator during the 100 ns interval immediately following the rising edge of the OUT pin. This digital filtering, also called leading-edge blanking, means that in most applications, no analog filtering (RC filter) is required on CS. Compared to an external RC filter technique, the leading-edge blanking provides a smaller effective CS to OUT propagation delay. Note, however, that the minimum non-zero on-time of the OUT signal is directly affected by the leading-edge-blanking and the CS to OUT propagation delay.

The over-current comparator is only intended for fault sensing, and exceeding the over-current threshold causes a soft start cycle.

#### FB

FB is the inverting input of the error amplifier. For best stability, keep the FB lead length as short as possible and the FB stray capacitance as small as possible.

#### ground (GND)

GND is reference ground and power ground for all functions on this part.

#### OUT

OUT is the output of a high-current power driver capable of driving the gate of a power MOSFET with peak currents exceeding  $\pm 750$  mA. OUT is actively held low when  $V_{CC}$  is below the UVLO threshold.

The high-current power driver consists of FET output devices, which can switch all of the way to GND and all of the way to  $V_{CC}$ . The output stage also provides a low impedance to overshoot and undershoot. This means that in many cases, external Schottky clamp diodes are not required.

## detailed descriptions (continued)

### RC

RC is the oscillator timing pin. For fixed frequency operation, set timing capacitor charging current by connecting a resistor from REF to RC. Set frequency by connecting timing capacitor from RC to GND. For the best performance, keep the timing capacitor lead to GND as short and direct as possible. If possible, use separate ground traces for the timing capacitor and all other functions.

The frequency of oscillation can be estimated with the following equations:

$$\text{UCC2800/01/02/04} : F = \frac{1.5}{R \times C}$$

$$\text{UCC2803/UCC2805} : F = \frac{1.0}{R \times C}$$

(1)

Where frequency is in Hz, resistance is in ohms, and capacitance is in farads. The recommended range of timing resistors is between 10 k $\Omega$  and 200 k $\Omega$  and the timing capacitor is 100 pF to 1000 pF. Never use a timing resistor less than 10 k $\Omega$ .

To prevent noise problems, bypass  $V_{CC}$  to GND with a ceramic capacitor as close to the  $V_{CC}$  pin as possible. An electrolytic capacitor may also be used in addition to the ceramic capacitor.

### voltage reference (REF)

REF is the voltage reference for the error amplifier and also for many other functions on the IC. REF is also used as the logic power supply for high speed switching logic on the IC.

When  $V_{CC}$  is greater than 1 V and less than the UVLO threshold, REF is pulled to ground through a 5-k $\Omega$  resistor. This means that REF can be used as a logic output indicating power system status. It is important for reference stability that REF is bypassed to GND with a ceramic capacitor as close to the pin as possible. An electrolytic capacitor may also be used in addition to the ceramic capacitor. A minimum of 0.1- $\mu$ F ceramic is required. Additional REF bypassing is required for external loads greater than 2.5 mA on the reference.

To prevent noise problems with high speed switching transients, bypass REF to ground with a ceramic capacitor close to the IC package.

### power ( $V_{CC}$ )

$V_{CC}$  is the power input connection for this device. In normal operation  $V_{CC}$  is powered through a current limiting resistor. Although quiescent  $V_{CC}$  current is low, total supply current will be higher, depending on OUT current. Total  $V_{CC}$  current is the sum of quiescent  $V_{CC}$  current and the average OUT current. Knowing the operating frequency and the MOSFET gate charge ( $Q_g$ ), average OUT current can be calculated from:

$$I_{OUT} = Q_g \times F.$$

(2)

# UCC2800/2801/2802/2803/2804/2805-Q1 LOW-POWER BICMOS CURRENT-MODE PWM

SGLS121C – JULY 2002 – REVISED APRIL 2008

## PARAMETER MEASUREMENT INFORMATION

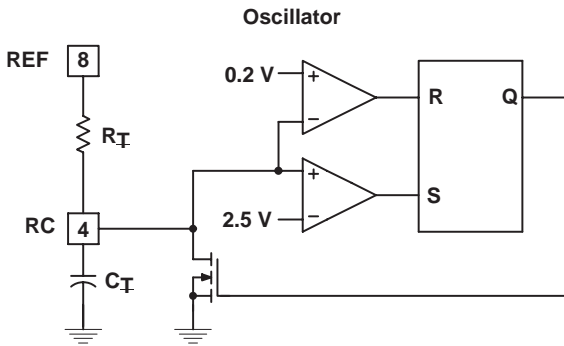

The UCC3800/1/2/3/4/5 oscillator generates a sawtooth waveform on RC. The rise time is set by the time constant of  $R_T$  and  $C_T$ . The fall time is set by  $C_T$  and an internal transistor on-resistance of approximately 125. During the fall time, the output is off and the maximum duty cycle is reduced below 50% or 100% depending on the part number. Larger timing capacitors increase the discharge time and reduce the maximum duty cycle and frequency.

Figure 1

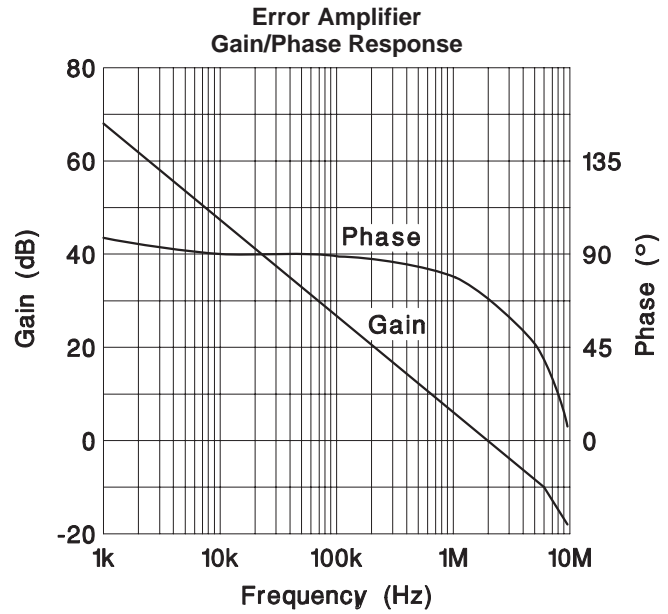

Figure 2

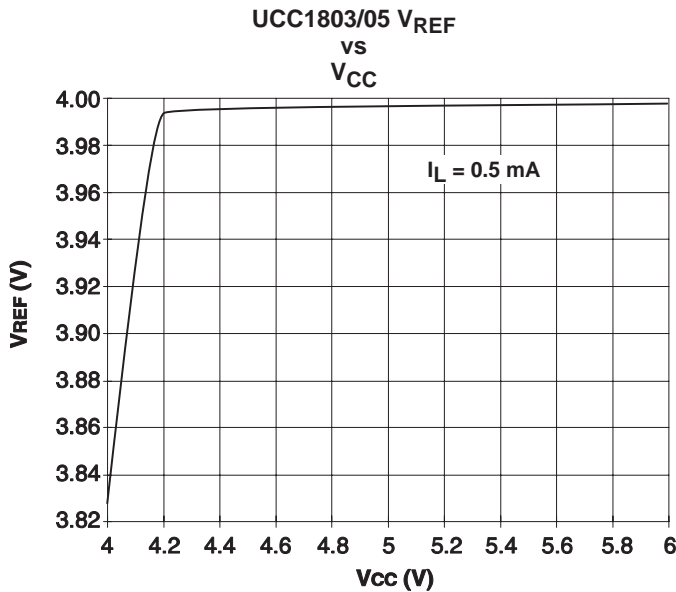

Figure 3

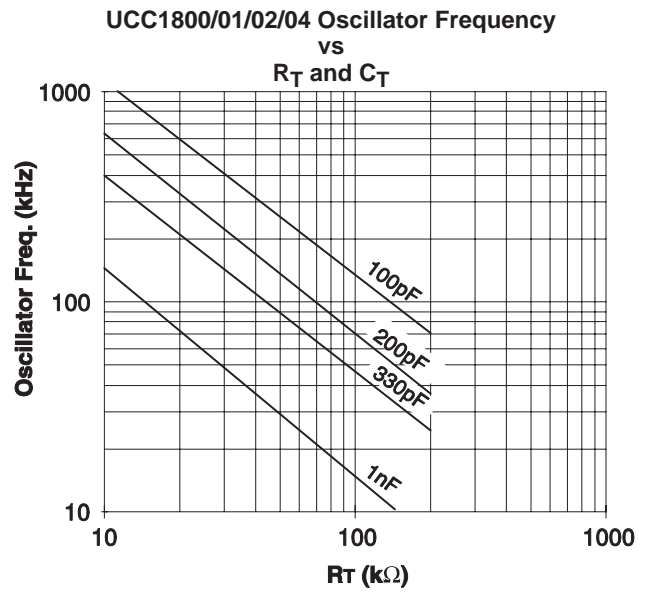

Figure 4



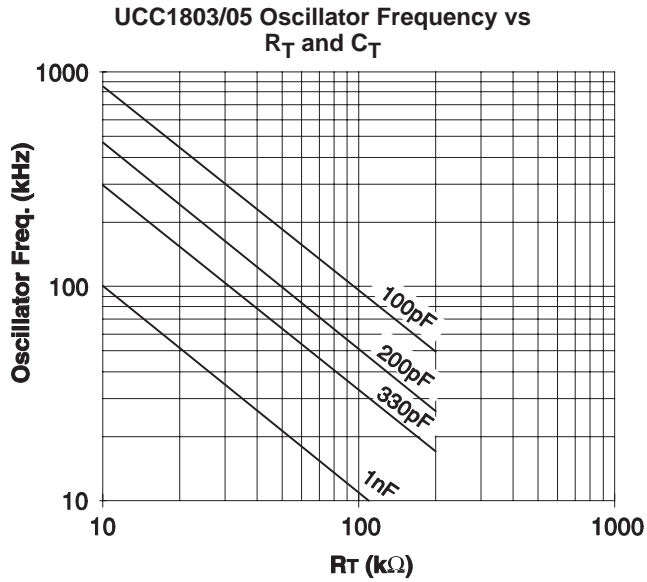

Figure 5

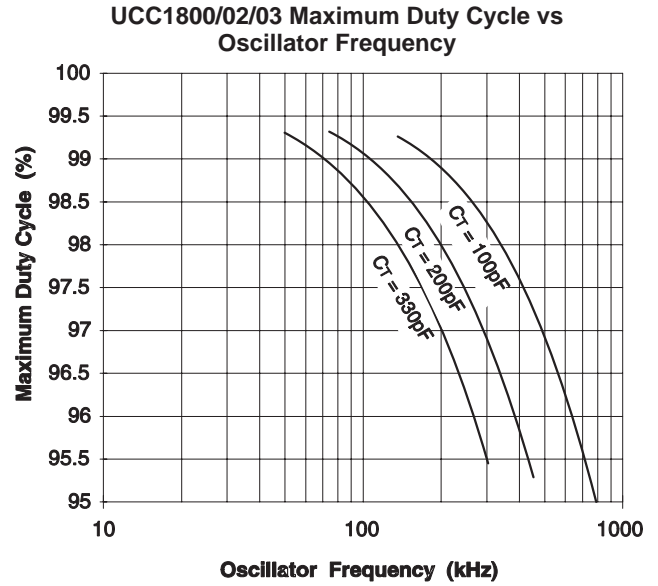

Figure 6

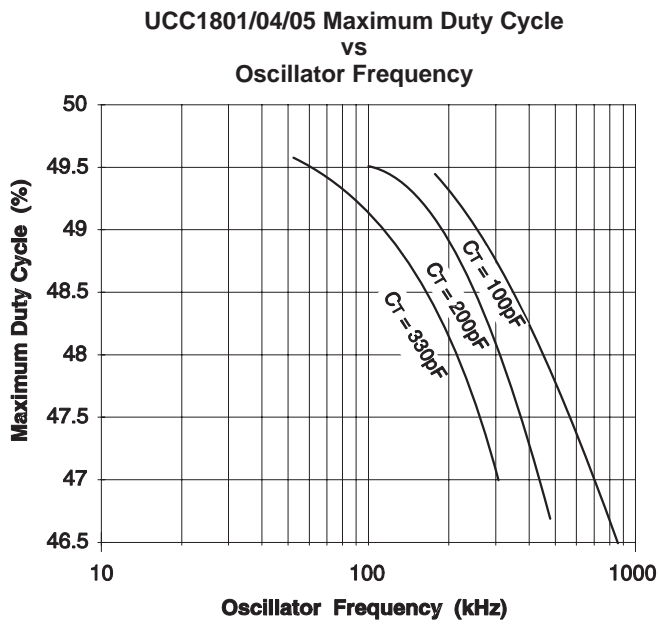

Figure 7

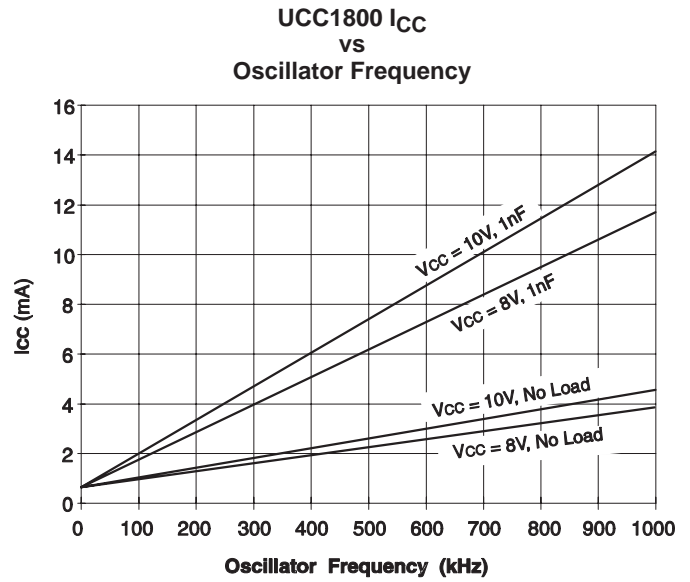

Figure 8

# UCC2800/2801/2802/2803/2804/2805-Q1 LOW-POWER BICMOS CURRENT-MODE PWM

SGLS121C – JULY 2002 – REVISED APRIL 2008

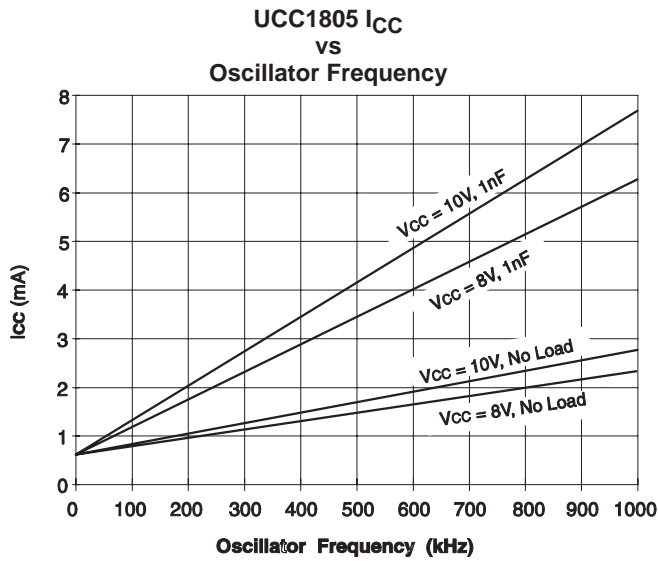

Figure 9

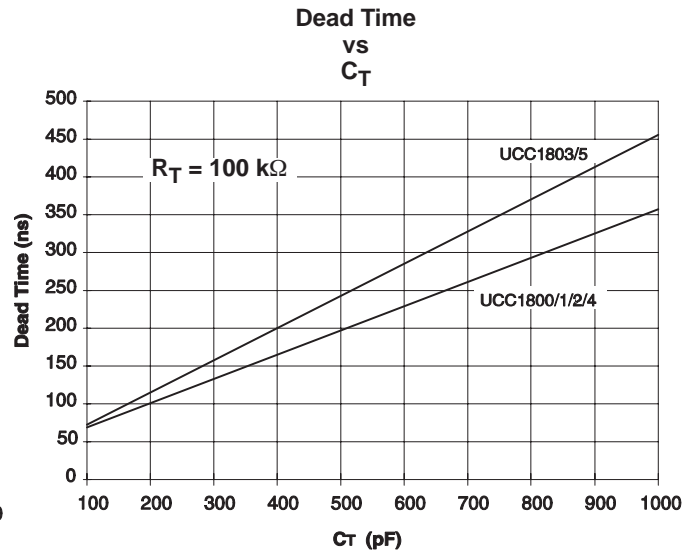

Figure 10

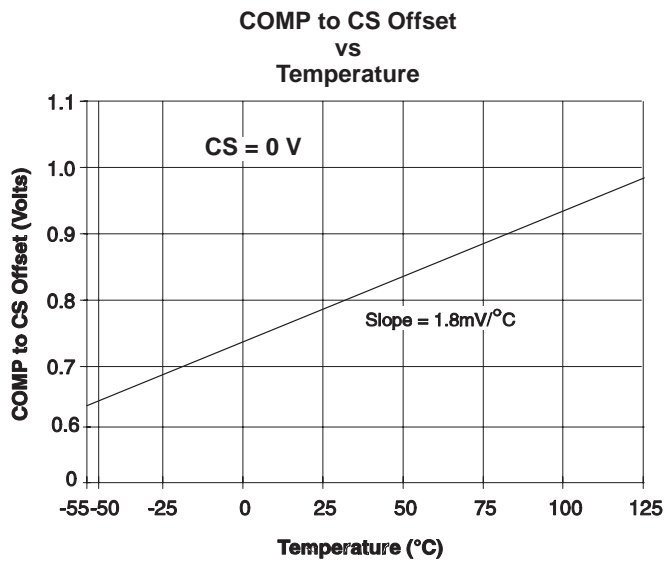

Figure 11

**PACKAGING INFORMATION**

Orderable Device	Status (1)	Package Type	Package Drawing	Pins	Package Qty	Eco Plan (2)	Lead/Ball Finish (6)	MSL Peak Temp (3)	Op Temp (°C)	Device Marking (4/5)	Samples
UCC2800QDRQ1	ACTIVE	SOIC	D	8	2500	Green (RoHS & no Sb/Br)	CU NIPDAU	Level-1-260C-UNLIM	-40 to 125	(C2800 ~ C2800DQ1)	<a href="#">Samples</a>
UCC2801QDRQ1	ACTIVE	SOIC	D	8	2500	Green (RoHS & no Sb/Br)	CU NIPDAU	Level-1-260C-UNLIM	-40 to 125	(C2801 ~ C2801DQ1)	<a href="#">Samples</a>
UCC2802QDRQ1	ACTIVE	SOIC	D	8	2500	Green (RoHS & no Sb/Br)	CU NIPDAU	Level-1-260C-UNLIM	-40 to 125	(C2802 ~ C2802DQ1)	<a href="#">Samples</a>
UCC2803QDRQ1	ACTIVE	SOIC	D	8	2500	Green (RoHS & no Sb/Br)	CU NIPDAU	Level-1-260C-UNLIM	-40 to 125	(C2803 ~ C2803DQ1)	<a href="#">Samples</a>
UCC2804QDRQ1	ACTIVE	SOIC	D	8	2500	Green (RoHS & no Sb/Br)	CU NIPDAU	Level-1-260C-UNLIM	-40 to 125	(C2804 ~ C2804DQ1)	<a href="#">Samples</a>
UCC2805QDRQ1	ACTIVE	SOIC	D	8	2500	Green (RoHS & no Sb/Br)	CU NIPDAU	Level-1-260C-UNLIM	-40 to 125	(C2805 ~ C2805DQ1)	<a href="#">Samples</a>

(1) The marketing status values are defined as follows:

**ACTIVE:** Product device recommended for new designs.

**LIFEBUY:** TI has announced that the device will be discontinued, and a lifetime-buy period is in effect.

**NRND:** Not recommended for new designs. Device is in production to support existing customers, but TI does not recommend using this part in a new design.

**PREVIEW:** Device has been announced but is not in production. Samples may or may not be available.

**OBSELETE:** TI has discontinued the production of the device.

(2) Eco Plan - The planned eco-friendly classification: Pb-Free (RoHS), Pb-Free (RoHS Exempt), or Green (RoHS & no Sb/Br) - please check <http://www.ti.com/productcontent> for the latest availability information and additional product content details.

**TBD:** The Pb-Free/Green conversion plan has not been defined.

**Pb-Free (RoHS):** TI's terms "Lead-Free" or "Pb-Free" mean semiconductor products that are compatible with the current RoHS requirements for all 6 substances, including the requirement that lead not exceed 0.1% by weight in homogeneous materials. Where designed to be soldered at high temperatures, TI Pb-Free products are suitable for use in specified lead-free processes.

**Pb-Free (RoHS Exempt):** This component has a RoHS exemption for either 1) lead-based flip-chip solder bumps used between the die and package, or 2) lead-based die adhesive used between the die and leadframe. The component is otherwise considered Pb-Free (RoHS compatible) as defined above.

**Green (RoHS & no Sb/Br):** TI defines "Green" to mean Pb-Free (RoHS compatible), and free of Bromine (Br) and Antimony (Sb) based flame retardants (Br or Sb do not exceed 0.1% by weight in homogeneous material)

(3) MSL, Peak Temp. - The Moisture Sensitivity Level rating according to the JEDEC industry standard classifications, and peak solder temperature.

(4) There may be additional marking, which relates to the logo, the lot trace code information, or the environmental category on the device.

(5) Multiple Device Markings will be inside parentheses. Only one Device Marking contained in parentheses and separated by a "~" will appear on a device. If a line is indented then it is a continuation of the previous line and the two combined represent the entire Device Marking for that device.

<sup>(6)</sup> Lead/Ball Finish - Orderable Devices may have multiple material finish options. Finish options are separated by a vertical ruled line. Lead/Ball Finish values may wrap to two lines if the finish value exceeds the maximum column width.

**Important Information and Disclaimer:** The information provided on this page represents TI's knowledge and belief as of the date that it is provided. TI bases its knowledge and belief on information provided by third parties, and makes no representation or warranty as to the accuracy of such information. Efforts are underway to better integrate information from third parties. TI has taken and continues to take reasonable steps to provide representative and accurate information but may not have conducted destructive testing or chemical analysis on incoming materials and chemicals. TI and TI suppliers consider certain information to be proprietary, and thus CAS numbers and other limited information may not be available for release.

In no event shall TI's liability arising out of such information exceed the total purchase price of the TI part(s) at issue in this document sold by TI to Customer on an annual basis.

**OTHER QUALIFIED VERSIONS OF UCC2800-Q1, UCC2801-Q1, UCC2802-Q1, UCC2803-Q1, UCC2804-Q1, UCC2805-Q1 :**

- Catalog: [UCC2800](#), [UCC2801](#), [UCC2802](#), [UCC2803](#), [UCC2804](#), [UCC2805](#)
- Enhanced Product: [UCC2800-EP](#), [UCC2801-EP](#), [UCC2802-EP](#), [UCC2803-EP](#), [UCC2804-EP](#), [UCC2805-EP](#)
- Military: [UCC2802M](#), [UCC2803M](#)

NOTE: Qualified Version Definitions:

- Catalog - TI's standard catalog product
- Enhanced Product - Supports Defense, Aerospace and Medical Applications
- Military - QML certified for Military and Defense Applications

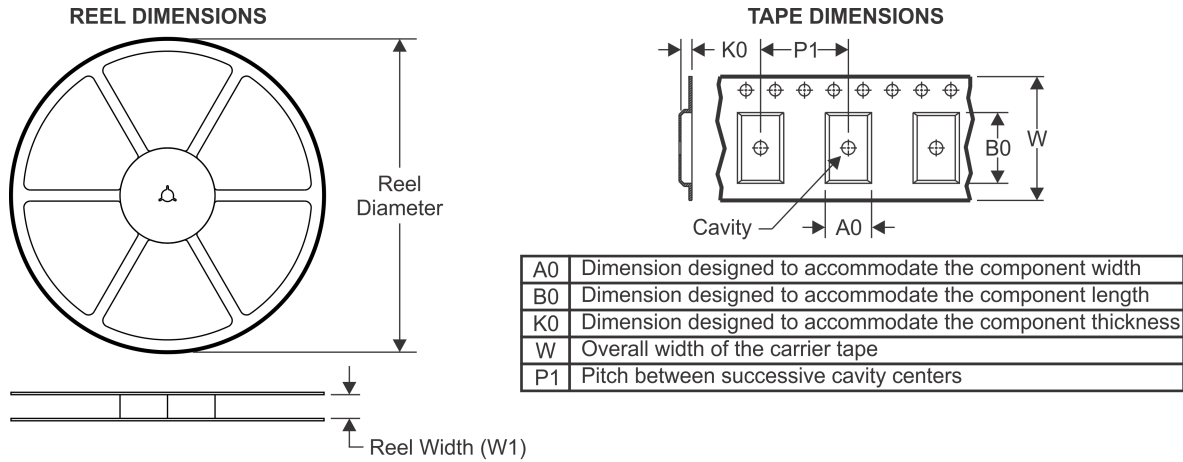
**TAPE AND REEL INFORMATION**

**QUADRANT ASSIGNMENTS FOR PIN 1 ORIENTATION IN TAPE**

\*All dimensions are nominal

Device	Package Type	Package Drawing	Pins	SPQ	Reel Diameter (mm)	Reel Width W1 (mm)	A0 (mm)	B0 (mm)	K0 (mm)	P1 (mm)	W (mm)	Pin1 Quadrant
UCC2800QDRQ1	SOIC	D	8	2500	330.0	12.4	6.4	5.2	2.1	8.0	12.0	Q1
UCC2801QDRQ1	SOIC	D	8	2500	330.0	12.4	6.4	5.2	2.1	8.0	12.0	Q1
UCC2802QDRQ1	SOIC	D	8	2500	330.0	12.4	6.4	5.2	2.1	8.0	12.0	Q1
UCC2803QDRQ1	SOIC	D	8	2500	330.0	12.4	6.4	5.2	2.1	8.0	12.0	Q1
UCC2804QDRQ1	SOIC	D	8	2500	330.0	12.4	6.4	5.2	2.1	8.0	12.0	Q1
UCC2805QDRQ1	SOIC	D	8	2500	330.0	12.4	6.4	5.2	2.1	8.0	12.0	Q1

**TAPE AND REEL BOX DIMENSIONS**

\*All dimensions are nominal

Device	Package Type	Package Drawing	Pins	SPQ	Length (mm)	Width (mm)	Height (mm)
UCC2800QDRQ1	SOIC	D	8	2500	367.0	367.0	35.0
UCC2801QDRQ1	SOIC	D	8	2500	367.0	367.0	35.0
UCC2802QDRQ1	SOIC	D	8	2500	367.0	367.0	35.0
UCC2803QDRQ1	SOIC	D	8	2500	367.0	367.0	35.0
UCC2804QDRQ1	SOIC	D	8	2500	367.0	367.0	35.0
UCC2805QDRQ1	SOIC	D	8	2500	367.0	367.0	35.0

D (R-PDSO-G8)

PLASTIC SMALL OUTLINE



NOTES: A. All linear dimensions are in inches (millimeters).  
 B. This drawing is subject to change without notice.  
 C. Body length does not include mold flash, protrusions, or gate burrs. Mold flash, protrusions, or gate burrs shall not exceed 0.006 (0,15) each side.  
 D. Body width does not include interlead flash. Interlead flash shall not exceed 0.017 (0,43) each side.  
 E. Reference JEDEC MS-012 variation AA.

D (R-PDSO-G8)

PLASTIC SMALL OUTLINE



- NOTES:
- A. All linear dimensions are in millimeters.
  - B. This drawing is subject to change without notice.
  - C. Publication IPC-7351 is recommended for alternate designs.
  - D. Laser cutting apertures with trapezoidal walls and also rounding corners will offer better paste release. Customers should contact their board assembly site for stencil design recommendations. Refer to IPC-7525 for other stencil recommendations.
  - E. Customers should contact their board fabrication site for solder mask tolerances between and around signal pads.



## IMPORTANT NOTICE

Texas Instruments Incorporated and its subsidiaries (TI) reserve the right to make corrections, enhancements, improvements and other changes to its semiconductor products and services per JESD46, latest issue, and to discontinue any product or service per JESD48, latest issue. Buyers should obtain the latest relevant information before placing orders and should verify that such information is current and complete. All semiconductor products (also referred to herein as "components") are sold subject to TI's terms and conditions of sale supplied at the time of order acknowledgment.

TI warrants performance of its components to the specifications applicable at the time of sale, in accordance with the warranty in TI's terms and conditions of sale of semiconductor products. Testing and other quality control techniques are used to the extent TI deems necessary to support this warranty. Except where mandated by applicable law, testing of all parameters of each component is not necessarily performed.

TI assumes no liability for applications assistance or the design of Buyers' products. Buyers are responsible for their products and applications using TI components. To minimize the risks associated with Buyers' products and applications, Buyers should provide adequate design and operating safeguards.

TI does not warrant or represent that any license, either express or implied, is granted under any patent right, copyright, mask work right, or other intellectual property right relating to any combination, machine, or process in which TI components or services are used. Information published by TI regarding third-party products or services does not constitute a license to use such products or services or a warranty or endorsement thereof. Use of such information may require a license from a third party under the patents or other intellectual property of the third party, or a license from TI under the patents or other intellectual property of TI.

Reproduction of significant portions of TI information in TI data books or data sheets is permissible only if reproduction is without alteration and is accompanied by all associated warranties, conditions, limitations, and notices. TI is not responsible or liable for such altered documentation. Information of third parties may be subject to additional restrictions.

Resale of TI components or services with statements different from or beyond the parameters stated by TI for that component or service voids all express and any implied warranties for the associated TI component or service and is an unfair and deceptive business practice. TI is not responsible or liable for any such statements.

Buyer acknowledges and agrees that it is solely responsible for compliance with all legal, regulatory and safety-related requirements concerning its products, and any use of TI components in its applications, notwithstanding any applications-related information or support that may be provided by TI. Buyer represents and agrees that it has all the necessary expertise to create and implement safeguards which anticipate dangerous consequences of failures, monitor failures and their consequences, lessen the likelihood of failures that might cause harm and take appropriate remedial actions. Buyer will fully indemnify TI and its representatives against any damages arising out of the use of any TI components in safety-critical applications.

In some cases, TI components may be promoted specifically to facilitate safety-related applications. With such components, TI's goal is to help enable customers to design and create their own end-product solutions that meet applicable functional safety standards and requirements. Nonetheless, such components are subject to these terms.

No TI components are authorized for use in FDA Class III (or similar life-critical medical equipment) unless authorized officers of the parties have executed a special agreement specifically governing such use.

Only those TI components which TI has specifically designated as military grade or "enhanced plastic" are designed and intended for use in military/aerospace applications or environments. Buyer acknowledges and agrees that any military or aerospace use of TI components which have **not** been so designated is solely at the Buyer's risk, and that Buyer is solely responsible for compliance with all legal and regulatory requirements in connection with such use.

TI has specifically designated certain components as meeting ISO/TS16949 requirements, mainly for automotive use. In any case of use of non-designated products, TI will not be responsible for any failure to meet ISO/TS16949.

### Products

Audio	<a href="http://www.ti.com/audio">www.ti.com/audio</a>
Amplifiers	<a href="http://amplifier.ti.com">amplifier.ti.com</a>
Data Converters	<a href="http://dataconverter.ti.com">dataconverter.ti.com</a>
DLP® Products	<a href="http://www.dlp.com">www.dlp.com</a>
DSP	<a href="http://dsp.ti.com">dsp.ti.com</a>
Clocks and Timers	<a href="http://www.ti.com/clocks">www.ti.com/clocks</a>
Interface	<a href="http://interface.ti.com">interface.ti.com</a>
Logic	<a href="http://logic.ti.com">logic.ti.com</a>
Power Mgmt	<a href="http://power.ti.com">power.ti.com</a>
Microcontrollers	<a href="http://microcontroller.ti.com">microcontroller.ti.com</a>
RFID	<a href="http://www.ti-rfid.com">www.ti-rfid.com</a>
OMAP Applications Processors	<a href="http://www.ti.com/omap">www.ti.com/omap</a>
Wireless Connectivity	<a href="http://www.ti.com/wirelessconnectivity">www.ti.com/wirelessconnectivity</a>

### Applications

Automotive and Transportation	<a href="http://www.ti.com/automotive">www.ti.com/automotive</a>
Communications and Telecom	<a href="http://www.ti.com/communications">www.ti.com/communications</a>
Computers and Peripherals	<a href="http://www.ti.com/computers">www.ti.com/computers</a>
Consumer Electronics	<a href="http://www.ti.com/consumer-apps">www.ti.com/consumer-apps</a>
Energy and Lighting	<a href="http://www.ti.com/energy">www.ti.com/energy</a>
Industrial	<a href="http://www.ti.com/industrial">www.ti.com/industrial</a>
Medical	<a href="http://www.ti.com/medical">www.ti.com/medical</a>
Security	<a href="http://www.ti.com/security">www.ti.com/security</a>
Space, Avionics and Defense	<a href="http://www.ti.com/space-avionics-defense">www.ti.com/space-avionics-defense</a>
Video and Imaging	<a href="http://www.ti.com/video">www.ti.com/video</a>

### TI E2E Community

[e2e.ti.com](http://e2e.ti.com)