

# TPS6280x 1.8-V to 5.5-V, 0.6A / 1-A, 2.3- $\mu$ A $I_Q$ Step Down Converter

## 6-Pin, 0.35-mm Pitch WCSP Package

### 1 Features

- Input Voltage Range from 1.8 V to 5.5 V
- 2.3- $\mu$ A Operating Quiescent Current
- Up to 4 MHz Switching Frequency
- Output Current 0.6 A / 1 A
- 1% Output Voltage Accuracy
- Selectable Power Save / Forced PWM Mode
- R2D converter for flexible  $V_{OUT}$  setting
- 16 Selectable + 1 Fixed Output Voltages
  - TPS62800 (4 MHz): 0.4 V to 0.775 V
  - TPS62801 (4 MHz): 0.8 V to 1.55 V
  - TPS62802 (4 MHz): 1.8 V to 3.3 V
  - TPS62806 (1.5 MHz): 0.4 V to 0.775 V
  - TPS62807 (1.5 MHz): 0.8 V to 1.55 V
  - TPS62808 (1.5 MHz): 1.8 V to 3.3 V
- Smart Enable Pin
- Optimized Pinout to Support 0201 Components
- DCS-Control™ Topology
- Output Discharge
- 100% Duty Cycle Operation
- Tiny 6-pin, 0.35 mm Pitch WCSP package
- Supports < 0.6 mm Solution Height
- Supports < 5 mm<sup>2</sup> Solution Size

### 2 Applications

- Wearable Electronics, IoT Applications
- 2xAA Battery Powered Applications
- Smart Phones

### 3 Description

The TPS6280x device family is a step down converter with 2.3- $\mu$ A typical quiescent current featuring highest efficiency and smallest solution size. TI's DCS-Control™ topology enables the device to operate with tiny inductors and capacitors with a switching frequency up to 4MHz. At light load conditions, it seamlessly enters Power Save Mode to reduce switching cycles and maintain high efficiency.

Connecting the VSEL/MODE pin to GND selects a fixed output voltage. With only one external resistor connected to VSEL/MODE pin, 16 internally set output voltages can be selected. An integrated R2D (resistor to digital) converter reads out the external resistor and sets the output voltage. The same device part number can be used for different applications and voltage rails just by changing a single resistor. Furthermore, the internally set output voltage provides better accuracy compared to a traditional external resistor divider network. Once the device has started up, the DC/DC converter enters Forced PWM Mode by applying a high level at the VSEL/MODE pin. In this operating mode, the device runs at a typical 4-MHz or 1.5-MHz switching frequency, enabling lowest output voltage ripple and highest efficiency. The TPS6280x device series comes in a tiny 6-pin WCSP package with 0.35-mm pitch.

#### Device Information<sup>(1)</sup>

PART NUMBER	PACKAGE	BODY SIZE (NOM)
TPS6280x	DSBGA (6)	1.05 mm x 0.70 mm x 0.4mm

(1) For all available packages, see the orderable addendum at the end of the datasheet.

#### Typical Application

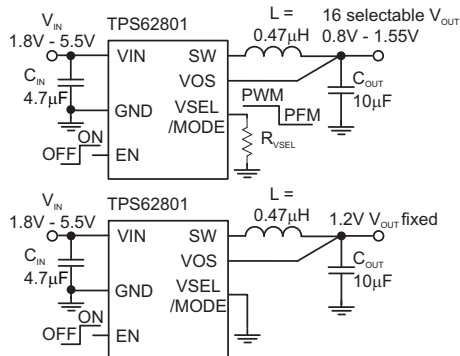

#### Efficiency vs. $I_{OUT}$ at 1.2V<sub>OUT</sub>

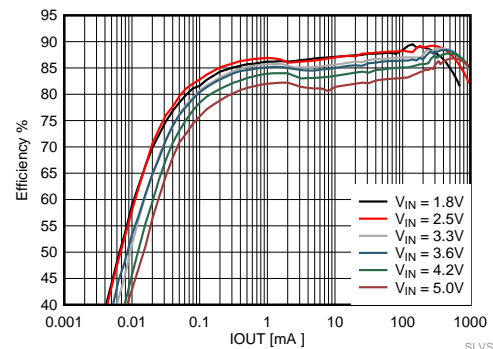

SLVS



## Table of Contents

<b>1</b>	<b>Features</b> .....	<b>1</b>	<b>9</b>	<b>Application and Implementation</b> .....	<b>14</b>
<b>2</b>	<b>Applications</b> .....	<b>1</b>	9.1	Application Information.....	14
<b>3</b>	<b>Description</b> .....	<b>1</b>	9.2	Typical Application .....	14
<b>4</b>	<b>Revision History</b> .....	<b>2</b>	9.3	System Examples .....	25
<b>5</b>	<b>Device Comparison Table</b> .....	<b>3</b>	<b>10</b>	<b>Power Supply Recommendations</b> .....	<b>27</b>
<b>6</b>	<b>Pin Configuration and Functions</b> .....	<b>3</b>	<b>11</b>	<b>Layout</b> .....	<b>27</b>
<b>7</b>	<b>Specifications</b> .....	<b>5</b>	11.1	Layout Guidelines .....	27
7.1	Absolute Maximum Ratings .....	5	11.2	Layout Example .....	27
7.2	ESD Ratings.....	5	<b>12</b>	<b>Device and Documentation Support</b> .....	<b>28</b>
7.3	Recommended Operating Conditions.....	5	12.1	Device Support.....	28
7.4	Thermal Information .....	6	12.2	Custom Design With WEBENCH® Tools .....	28
7.5	Electrical Characteristics.....	6	12.3	Related Links .....	28
7.6	Typical Characteristics .....	8	12.4	Community Resources.....	28
<b>8</b>	<b>Detailed Description</b> .....	<b>10</b>	12.5	Trademarks .....	29
8.1	Overview .....	10	12.6	Electrostatic Discharge Caution.....	29
8.2	Functional Block Diagram .....	10	12.7	Glossary .....	29
8.3	Feature Description.....	10	<b>13</b>	<b>Mechanical, Packaging, and Orderable Information</b> .....	<b>29</b>
8.4	Device Functional Modes.....	13			

## 4 Revision History

NOTE: Page numbers for previous revisions may differ from page numbers in the current version.

<b>Changes from Revision D (July 2018) to Revision E</b>	<b>Page</b>
• Added devices TPS62807 and TPS62808 throughout data sheet.....	<b>1</b>

---

<b>Changes from Revision C (June 2018) to Revision D</b>	<b>Page</b>
• Added device <i>TPS62800</i> to the data sheet .....	<b>1</b>
• Changed the $I_{LIMF}$ High side and Low side values in the <i>Electrical Characteristics</i> table .....	<b>6</b>

---

<b>Changes from Revision B (May 2018) to Revision C</b>	<b>Page</b>
• Changed TPS62802 From: <i>Advanced Information</i> To: <i>Production</i> data.....	<b>1</b>
• Changed the YKA pinout image appearance .....	<b>3</b>
• Added the <a href="#">Optimized Transient Performance from PWM to PFM Mode Operation</a> section .....	<b>13</b>
• Added <a href="#">Figure 52</a> to <a href="#">Figure 56</a> .....	<b>22</b>
• Changed <a href="#">Figure 63</a> .....	<b>27</b>

---

<b>Changes from Revision A (March 2018) to Revision B</b>	<b>Page</b>
• Added TPS62802 application curves. ....	<b>17</b>

---

<b>Changes from Original (December 2017) to Revision A</b>	<b>Page</b>
• Production Data release .....	<b>1</b>

## 5 Device Comparison Table

Device	Function VSEL/MODE	Fixed VOUT	Selectable Output Voltages with R <sub>VSEL</sub>	f <sub>sw</sub> [MHz]	I <sub>OUT</sub> [A]	Soft Start t <sub>SS</sub>	Output Discharge
TPS62800	VSEL + MODE	0.7V (VSEL / MODE = GND)	0.4V - 0.775V in 25mV steps	4	1	125 μs	Yes
TPS62801	VSEL + MODE	1.20V (VSEL / MODE = GND)	0.8V - 1.55V in 50mV steps	4	1	125 μs	Yes
TPS62802	VSEL + MODE	1.8V (VSEL / MODE = GND)	1.8V - 3.3V in 100mV steps	4	1	400 μs	Yes
TPS62806	VSEL + MODE	0.7V (VSEL / MODE = GND)	0.4V - 0.775V in 25mV steps	1.5	0.6	125 μs	Yes
TPS62807	VSEL + MODE	1.20V (VSEL / MODE = GND)	0.8V - 1.55V in 50mV steps	1.5	0.6	125 μs	Yes
TPS62808	VSEL + MODE	1.8V (VSEL / MODE = GND)	1.8V - 3.3V in 100mV steps	1.5	0.6	125 μs	Yes

## 6 Pin Configuration and Functions

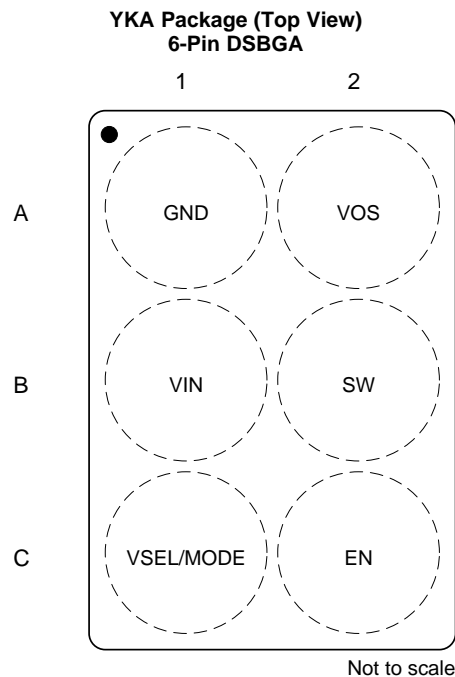

### Pin Functions

PIN		I/O	DESCRIPTION
NAME	NO.		
GND	A1	PWR	GND supply pin. Connect this pin close to the GND terminal of the input and output capacitor.
VIN	B1	PWR	V <sub>IN</sub> power supply pin. Connect the input capacitor close to this pin for best noise and voltage spike suppression. A ceramic capacitor is required.
VSEL/MODE	C1	IN	Connecting a resistor to GND selects a pre-defined output voltage. Once the device has started up, the R2D converter is disabled and the pin operates as an input. Applying a high level selects forced PWM mode operation and a low level power save mode operation.
VOS	A2	IN	Output voltage sense pin for the internal feedback divider network and regulation loop. This pin also discharges V <sub>OUT</sub> by an internal MOSFET, when the converter is disabled. Connect this pin directly to the output capacitor with a short trace.
SW	B2	OUT	The switch pin is connected to the internal MOSFET switches. Connect the inductor to this terminal.
EN	C2	IN	A high level enables the devices, and a low level turns the device off. The pin features an internal pulldown resistor, which is disabled once the device has started up.

**Table 1. Output Voltage Setting (VSEL/MODE Pin)**

VSEL	Output voltage setting V <sub>OUT</sub> [V]			R <sub>VSEL</sub> Resistance [kΩ], E96 Resistor Series, 1% Accuracy, Temperature Coefficient better or equal than ±200 ppm/°C
	TPS62800 TPS62806	TPS62801 TPS62807	TPS62802 TPS62808	
0	0.700	1.2	1.8	Connected to GND (no resistor needed)
1	0.400	0.8	1.8	10.0
2	0.425	0.85	1.9	12.1
3	0.450	0.9	2.0	15.4
4	0.475	0.95	2.1	18.7
5	0.500	1.0	2.2	23.7
6	0.525	1.05	2.3	28.7
7	0.550	1.1	2.4	36.5
8	0.575	1.15	2.5	44.2
9	0.600	1.2	2.6	56.2
10	0.625	1.25	2.7	68.1
11	0.650	1.3	2.8	86.6
12	0.675	1.35	2.9	105.0
13	0.700	1.4	3.0	133.0
14	0.725	1.45	3.1	162.0
15	0.750	1.5	3.2	205.0
16	0.775	1.55	3.3	249.0 or larger

## 7 Specifications

### 7.1 Absolute Maximum Ratings<sup>(1)</sup>

		MIN	MAX	UNIT
Pin voltage <sup>(2)</sup>	V <sub>IN</sub>	-0.3	6	V
	SW	-0.3	V <sub>IN</sub> + 0.3V	V
	SW (AC), less than 10ns, while switching	-2.5	9	V
	EN, VSEL/MODE	-0.3	6	V
	VOS	-0.3	5	V
Operating junction temperature, T <sub>J</sub>		-40	150	°C
Storage temperature, T <sub>stg</sub>		-65	150	°C

- (1) Stresses beyond those listed under *absolute maximum ratings* may cause permanent damage to the device. These are stress ratings only and functional operation of the device at these or any other conditions beyond those indicated under *recommended operating conditions* is not implied. Exposure to absolute–maximum–rated conditions for extended periods may affect device reliability.
- (2) All voltage values are with respect to network ground terminal GND.

### 7.2 ESD Ratings

			VALUE	UNIT
V <sub>(ESD)</sub>	Electrostatic discharge	Human body model (HBM), per ANSI/ESDA/JEDEC JS-001, all pins <sup>(1)</sup>	±2000	V
		Charged device model (CDM), per JEDEC specification JESD22-C101, all pins <sup>(2)</sup>	±500	

- (1) JEDEC document JEP155 states that 500-V HBM allows safe manufacturing with a standard ESD control process. The human body model is a 100-pF capacitor discharged through a 1.5-kΩ resistor into each pin.
- (2) JEDEC document JEP157 states that 250-V CDM allows safe manufacturing with a standard ESD control process.

### 7.3 Recommended Operating Conditions

		MIN	NOM	MAX	UNIT
V <sub>IN</sub>	Supply voltage V <sub>IN</sub>	1.8		5.5	V
I <sub>OUT</sub>	Output current V <sub>IN</sub> ≥ 2.3V, TPS62800, TPS62801, TPS62802			1	A
I <sub>OUT</sub>	Output current V <sub>IN</sub> < 2.3V, TPS62800, TPS62801, TPS62802			0.7	A
I <sub>OUT</sub>	Output current TPS62806, TPS62807, TPS62808			0.6	A
L	Effective inductance TPS62800, TPS62801, TPS62802	0.33	0.47	0.82	μH
C <sub>OUT</sub>	Effective output capacitance, TPS62800, TPS62801, TPS62802	2		26	μF
L	Effective inductance TPS62806, TPS62807, TPS62808	0.7	1.0	1.2	μH
C <sub>OUT</sub>	Effective output capacitance TPS62806, TPS62807, TPS62808	3		26	μF
C <sub>IN</sub>	Effective input capacitance	0.5	4.7		μF
C <sub>VSEL/MODE</sub>	External parasitic capacitance at VSEL/MODE pin			30	pF
R <sub>VSEL</sub>	Resistance range for external resistor at VSEL/MODE pin (E96 1% resistor values)	10		249	kΩ
	External resistor tolerance E96 series at VSEL/MODE pin			1%	
	E96 resistor series temperature coefficient (TCR)	-200		+200	ppm/°C
T <sub>J</sub>	Operating junction temperature range	-40		125	°C

## 7.4 Thermal Information

THERMAL METRIC <sup>(1)</sup>		YKA (DSBGA) 6 PINS	UNIT
R <sub>θJA</sub>	Junction-to-ambient thermal resistance	147.7	°C/W
R <sub>θJC(top)</sub>	Junction-to-case (top) thermal resistance	1.7	°C/W
R <sub>θJB</sub>	Junction-to-board thermal resistance	47.5	°C/W
ψ <sub>JT</sub>	Junction-to-top characterization parameter	0.5	°C/W
ψ <sub>JB</sub>	Junction-to-board characterization parameter	47.6	°C/W
R <sub>θJC(bot)</sub>	Junction-to-case (bottom) thermal resistance	–	°C/W

(1) For more information about traditional and new thermal metrics, see the [Semiconductor and IC Package Thermal Metrics](#) application report.

## 7.5 Electrical Characteristics

V<sub>IN</sub> = 3.6 V, T<sub>J</sub> = –40°C to 125°C typical values are at T<sub>J</sub> = 25°C (unless otherwise noted)

PARAMETER		TEST CONDITIONS	MIN	TYP	MAX	UNIT
<b>SUPPLY</b>						
I <sub>Q</sub>	Operating quiescent current (Power Save Mode)	EN = V <sub>IN</sub> , I <sub>OUT</sub> = 0μA, V <sub>OUT</sub> = 1.2 V device not switching, T <sub>J</sub> = –40°C to +85°C		2.3	4	μA
		EN = V <sub>IN</sub> , I <sub>OUT</sub> = 0μA, V <sub>OUT</sub> = 1.2 V, device switching		2.5		μA
	Operating quiescent current (PWM Mode)	EN = V <sub>IN</sub> , VSEL/MODE = V <sub>IN</sub> (after power up) device switching, I <sub>OUT</sub> = 0mA, V <sub>OUT</sub> = 1.2V		8		mA
I <sub>SD</sub>	Shutdown current	EN = GND, shutdown current into V <sub>IN</sub> VSEL/MODE = GND, T <sub>J</sub> = –40°C to +85°C		120	250	nA
V <sub>TH_UVLO+</sub>	Undervoltage lockout threshold	Rising V <sub>IN</sub>		1.65	1.8	V
V <sub>TH_UVLO–</sub>		Falling V <sub>IN</sub>		1.56	1.7	V
<b>INPUT EN</b>						
V <sub>IH_TH</sub>	High level input voltage		0.8			V
V <sub>IL_TH</sub>	Low level input voltage				0.4	V
I <sub>IN</sub>	Input bias current	T <sub>J</sub> = –40°C to +85°C, EN = high		10	25	nA
R <sub>PD</sub>	Internal pulldown resistance	EN = low		500		kΩ
<b>INPUT VSEL/MODE</b>						
V <sub>IH_TH</sub>	High level input voltage (digital input)		0.8			V
V <sub>IL_TH</sub>	Low level input voltage (digital input)				0.4	V
I <sub>IN</sub>	Input bias current	EN = high		10	25	nA
<b>POWER SWITCHES</b>						
I <sub>LKG_SW</sub>	Leakage current into SW pin	V <sub>SW</sub> = 1.2V, T <sub>J</sub> = –40°C to +85°C		10	25	nA
R <sub>DS(ON)</sub>	High side MOSFET on-resistance	I <sub>OUT</sub> = 500 mA		120	170	mΩ
	Low side MOSFET on-resistance	I <sub>OUT</sub> = 500 mA		80	115	mΩ
I <sub>LIMF</sub>	High side MOSFET switch current limit	TPS62806, TPS62807, TPS62808	0.95	1.1	1.2	A
I <sub>LIMF</sub>	Low side MOSFET switch current limit	TPS62806, TPS62807, TPS62808	0.85	1	1.1	A
I <sub>LIMF</sub>	High side MOSFET switch current limit	TPS62800, TPS62801	1.3	1.45	1.55	A
		TPS62802	1.4	1.55	1.65	A
I <sub>LIMF</sub>	Low side MOSFET switch current limit	TPS62800, TPS62801	1.2	1.35	1.45	A
		TPS62802	1.3	1.45	1.55	A
<b>OUTPUT VOLTAGE DISCHARGE</b>						
R <sub>DSCH_VOS</sub>	MOSFET on-resistance	EN = GND, I <sub>VOS</sub> = –10 mA into VOS pin T <sub>J</sub> = –40°C to +85°C		7	11	Ω
I <sub>IN_VOS</sub>	Bias current into VOS pin	EN = V <sub>IN</sub> , V <sub>OUT</sub> = 1.2 V (internal 12MΩ resistor divider), T <sub>J</sub> = –40°C to +85°C		100	400	nA

**Electrical Characteristics (continued)**
 $V_{IN} = 3.6\text{ V}$ ,  $T_J = -40^\circ\text{C}$  to  $125^\circ\text{C}$  typical values are at  $T_J = 25^\circ\text{C}$  (unless otherwise noted)

PARAMETER		TEST CONDITIONS	MIN	TYP	MAX	UNIT
<b>THERMAL PROTECTION</b>						
$T_{SD}$	Thermal shutdown temperature	Rising Junction Temperature, PWM mode		160		$^\circ\text{C}$
	Thermal shutdown hysteresis			20		$^\circ\text{C}$
<b>OUTPUT</b>						
$V_{OUT}$	Output voltage range	TPS62800, TPS62806, 25mV steps	0.4		0.775	V
$V_{OUT}$	Output voltage range	TPS62801, TPS62807, 50mV steps	0.8		1.55	V
$V_{OUT}$	Output voltage range	TPS62802, TPS62808, 100mV steps	1.8		3.3	V
$V_{OUT}$	Output voltage accuracy	Power Save Mode		0%		
$V_{OUT}$	Output voltage accuracy	PWM Mode $I_{OUT} = 0\text{ mA}$ , $T_J = 25^\circ\text{C}$ to $+85^\circ\text{C}$	-1%	0%	1%	
$V_{OUT}$	Output voltage accuracy	PWM Mode $I_{OUT} = 0\text{ mA}$ , $T_J = -40^\circ\text{C}$ to $+125^\circ\text{C}$	-2%	0%	1.7%	
$f_{SW}$	Switching frequency	$V_{IN} = 3.6\text{V}$ , $V_{OUT} = 1.2\text{V}$ , PWM operation		4		MHz
$f_{SW}$	Switching frequency	TPS62806 $V_{IN} = 3.6\text{V}$ , $V_{OUT} = 0.7\text{V}$ , PWM operation		1.5		MHz
$f_{SW}$	Switching frequency	TPS62807 $V_{IN} = 3.6\text{V}$ , $V_{OUT} = 1.2\text{V}$ , PWM operation		1.5		MHz
$f_{SW}$	Switching frequency	TPS62808 $V_{IN} = 3.6\text{V}$ , $V_{OUT} = 1.8\text{V}$ , PWM operation		1.5		MHz
$t_{Startup\_delay}$	Regulator start up delay time	From transition EN = low to high until device starts switching, VSEL = 16		500	1100	$\mu\text{s}$
$t_{SS}$	Soft start time	TPS62801, from $V_{OUT} = 0\text{V}$ to 0.95% of $V_{OUT}$ nominal		125	170	$\mu\text{s}$
$t_{SS}$	Soft start time	TPS62800, TPS62806, TPS62807, TPS62808 from $V_{OUT} = 0\text{V}$ to 0.95% of $V_{OUT}$ nominal		125	210	$\mu\text{s}$
$t_{SS}$	Soft start time	TPS62802, from $V_{OUT} = 0\text{V}$ to 0.95% of $V_{OUT}$ nominal		400	500	$\mu\text{s}$

## 7.6 Typical Characteristics

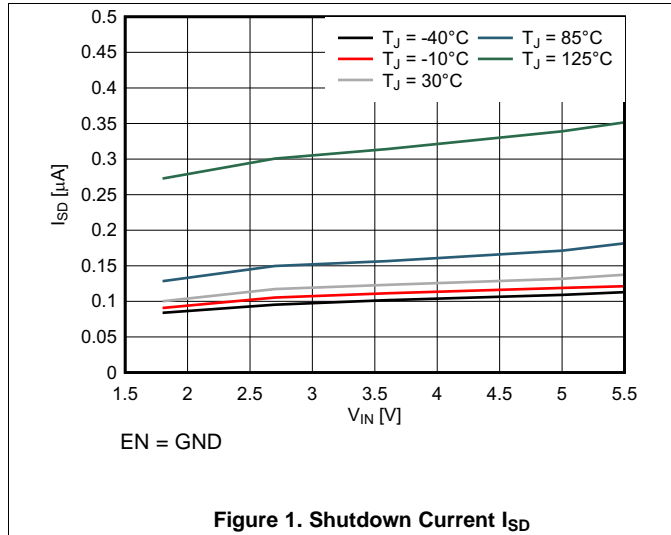

Figure 1. Shutdown Current  $I_{SD}$

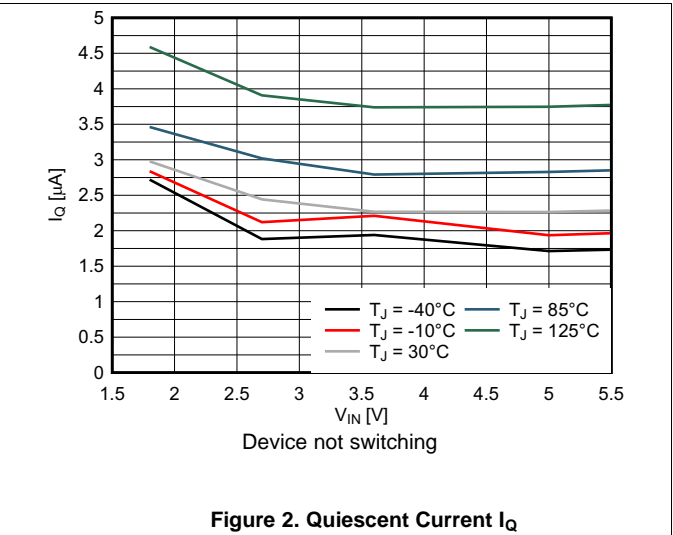

Figure 2. Quiescent Current  $I_Q$

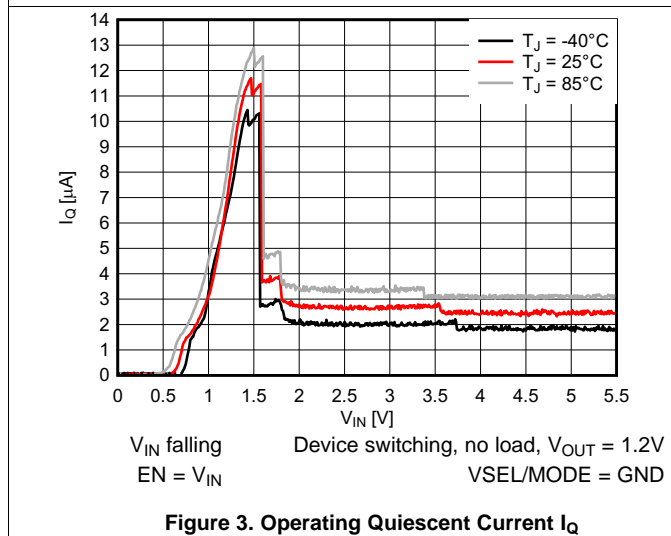

Figure 3. Operating Quiescent Current  $I_Q$

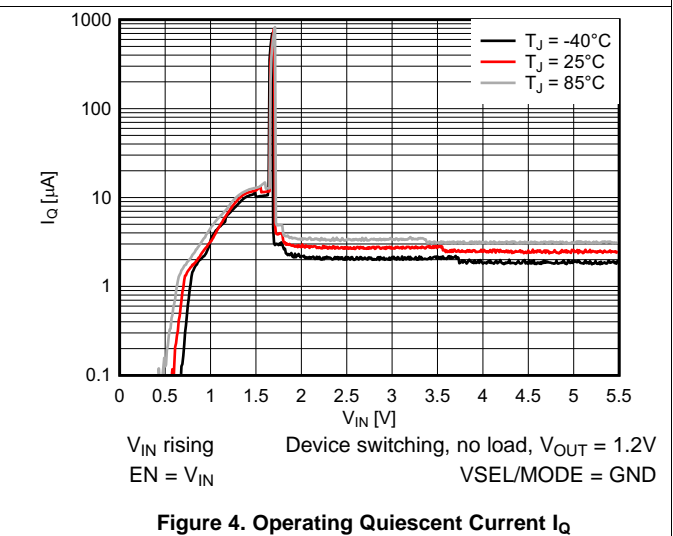

Figure 4. Operating Quiescent Current  $I_Q$

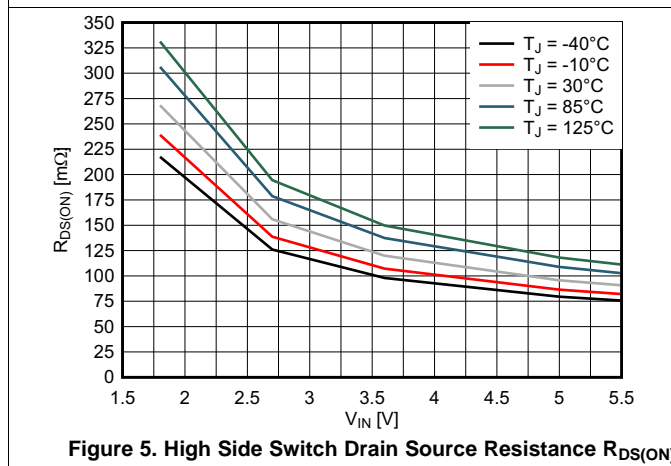

Figure 5. High Side Switch Drain Source Resistance  $R_{DS(ON)}$

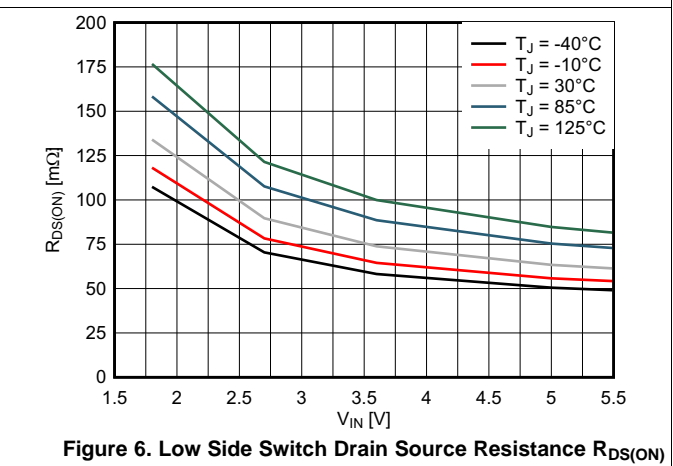
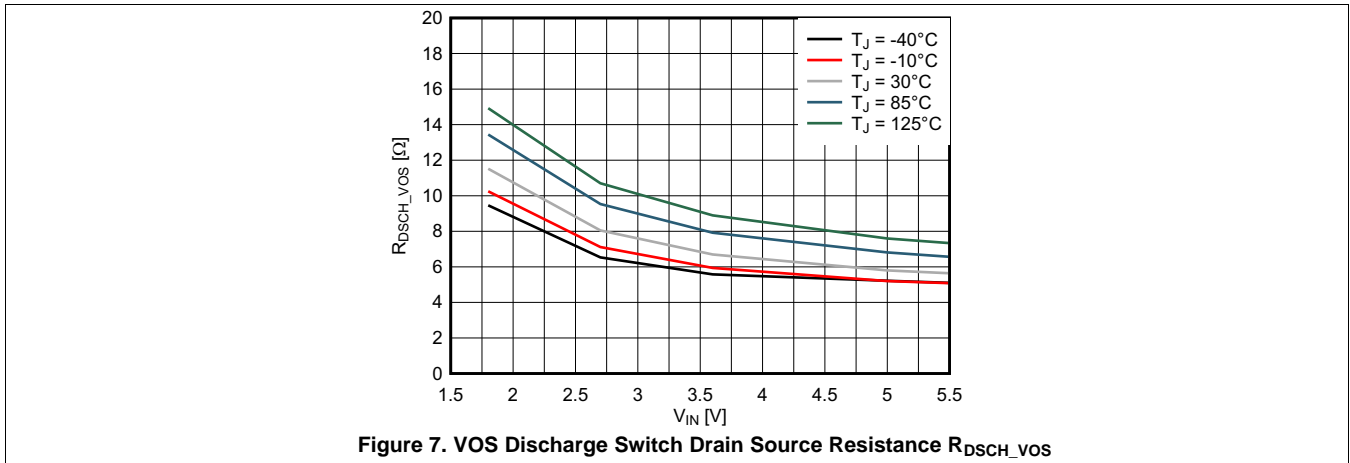

Figure 6. Low Side Switch Drain Source Resistance  $R_{DS(ON)}$



**Typical Characteristics (continued)**



## 8 Detailed Description

### 8.1 Overview

The TPS6280x is a high frequency synchronous step down converter with ultra low quiescent current consumption. Using TI's DCS-Control™ topology, the device extends the high efficiency operation area down to microamperes of load current during Power Save Mode Operation. TI's DCS-Control™ (Direct Control with Seamless Transition into Power Save Mode) is an advanced regulation topology, which combines the advantages of hysteretic and voltage mode control. Characteristics of DCS-Control™ are excellent AC load regulation and transient response, low output ripple voltage and a seamless transition between PFM and PWM mode operation. DCS-Control™ includes an AC loop which senses the output voltage (VOS pin) and directly feeds the information to a fast comparator stage. This comparator sets the switching frequency, which is constant for steady state operating conditions, and provides immediate response to dynamic load changes. In order to achieve accurate DC load regulation, a voltage feedback loop is used. The internally compensated regulation network achieves fast and stable operation with small external components and low ESR capacitors.

### 8.2 Functional Block Diagram

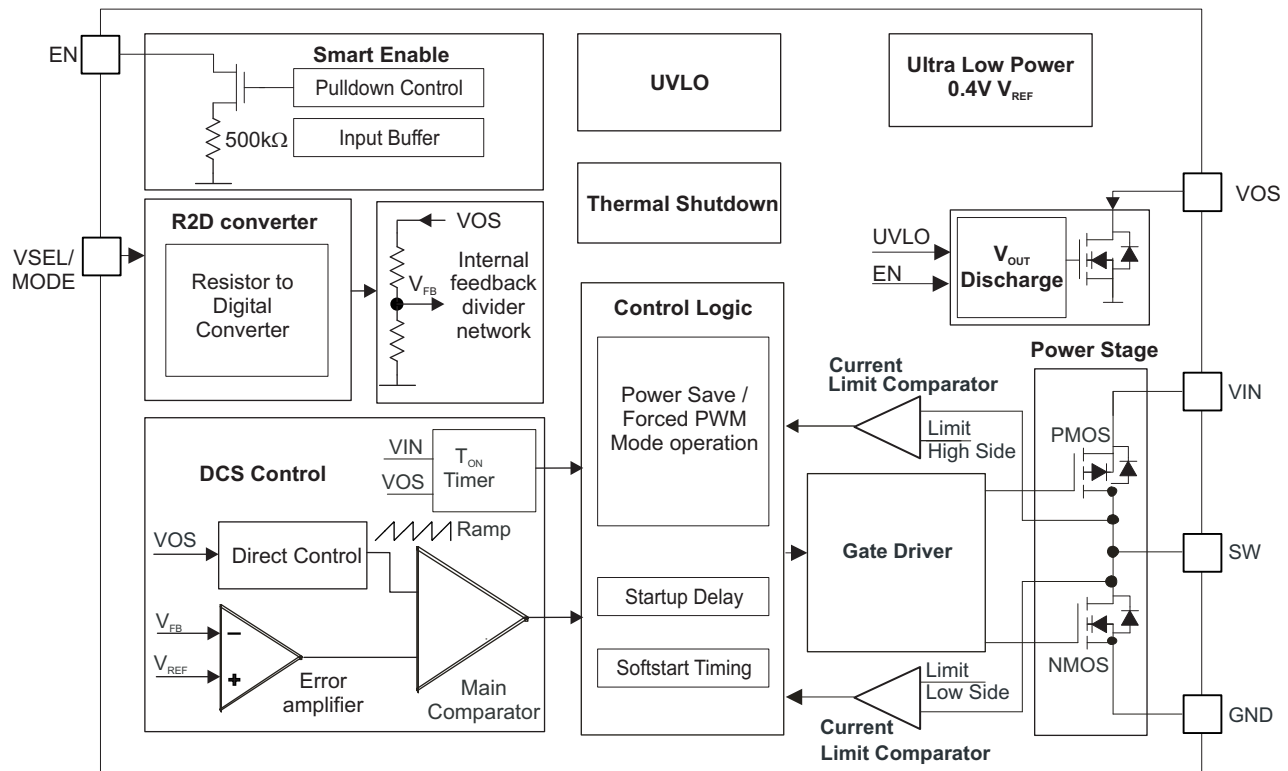

**Figure 8. Functional Block Diagram**

### 8.3 Feature Description

#### 8.3.1 Smart Enable and Shutdown (EN)

An internal 500kΩ resistor pulls the EN pin to GND and avoids the pin to be floating. This prevents an uncontrolled startup of the device in case the EN pin cannot be driven to low level safely. With EN low, the device is in shutdown mode. The device is turned on with EN set to a high level. The pull-down control circuit disconnects the pull-down resistor on the EN pin once the internal control logic and the reference have been powered up. With EN set to a low level, the device enters shutdown mode and the pull-down resistor is activated again.

## Feature Description (continued)

### 8.3.2 Softstart

Once the device has been enabled with EN high, it initializes and powers up its internal circuits. This occurs during the regulator startup delay time  $t_{\text{Startup\_delay}}$ . Once  $t_{\text{Startup\_delay}}$  expires, the internal soft start circuitry ramps up the output voltage within the Soft start time  $t_{\text{SS}}$ , see [Figure 9](#).

The startup delay time  $t_{\text{Startup\_delay}}$  varies depending on the selected VSEL value. It is shortest with VSEL = 0 and longest with VSEL = 16. See [Figure 52](#) to [Figure 56](#).

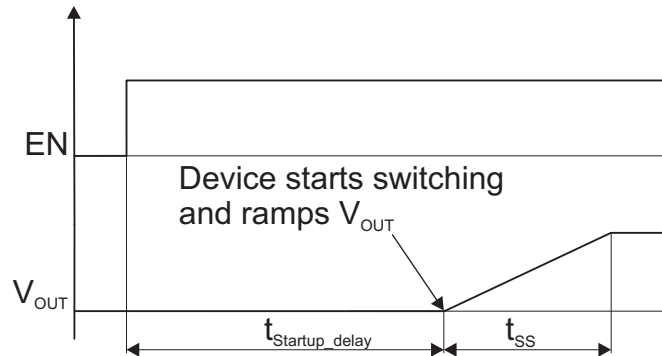

**Figure 9. Device Startup**

### 8.3.3 VSEL/MODE Pin

This pin has two functions, output voltage selection during startup of the converter and operating mode selection. See also [Device Comparison Table](#).

#### 8.3.3.1 Output Voltage Selection (R2D Converter)

The output voltage is set with a single external resistor connected between the VSEL/MODE pin and GND. Once the device has been enabled and the control logic as well as the internal reference have been powered up, a R2D (resistor to digital) conversion is started to detect the external resistor  $R_{\text{VSEL}}$  within the regulator startup delay time  $t_{\text{Startup\_delay}}$ . An internal current source applies current through the external resistor and an internal ADC reads back the resulting voltage level. Depending on the level, an internal feedback divider network is selected to set the correct output voltage. Once this R2D conversion is finished, the current source is turned off to avoid current flow through the external resistor.

After power up, the pin is configured as an input for Mode Selection. Therefore, the output voltage is set only once. If the Mode selection function is used in combination with the VSEL function, ensure that there is no additional current path or capacitance greater than 30pF total to GND, during R2D conversion. Otherwise the additional current to GND is interpreted as a lower resistor value and a false output voltage will be set. [Table 1](#) lists the correct resistor values for  $R_{\text{VSEL}}$  to set the appropriate output voltages. The R2D converter is designed to operate with resistor values out of the E96 table and requires 1% resistor value accuracy. The external resistor  $R_{\text{VSEL}}$  is not a part of the regulator feedback loop and has therefore no impact on the output voltage accuracy. Ensure that there is no other leakage path than the  $R_{\text{VSEL}}$  resistor at the VSEL/MODE pin during an undervoltage lockout event. Otherwise a false output voltage will be set.

Connecting VSEL/MODE to GND selects a pre-defined output voltage (TPS62800 = 0.7 V, TPS62801 = 1.2 V, TPS62802 = 1.8 V, TPS62806 = 0.7 V, TPS62807 = 1.2 V, TPS62808 = 1.8 V). In this case, no external resistor is needed which enables a smaller solution size.

#### 8.3.3.2 Mode Selection: Power Save Mode / Forced PWM Operation

A low level at this pin selects Power Save Mode operation, and a high level selects forced PWM operation. The Mode can be changed during operation after the device has been powered up. The Mode selection function is only available after the R2D converter has read out the external resistor.

## Feature Description (continued)

### 8.3.4 Undervoltage Lockout (UVLO)

To avoid misoperation of the device at low input voltages, an undervoltage lockout (UVLO) comparator monitors the supply voltage. The UVLO comparator shuts down the device at an input voltage of 1.7V (max) with falling  $V_{IN}$ . The device starts at an input voltage of 1.8V (max) rising  $V_{IN}$ . Once the device re-enters operation out of an undervoltage lockout condition, it behaves like being enabled. The internal control logic is powered up and the external resistor at the VSEL/MODE pin is read out.

### 8.3.5 Switch Current Limit / Short Circuit Protection

The TPS6280x integrates a current limit on the high side, as well on the low side MOSFETs to protect the device against overload or short circuit conditions. The current in the switches is monitored cycle by cycle. If the high side MOSFET current limit  $I_{LIMF}$  trips, the high side MOSFET is turned off and the low side MOSFET is turned on to ramp down the inductor current. Once the inductor current through the low side switch decreases below the low side MOSFET current limit  $I_{LIMF}$ , the low side MOSFET is turned off and the high side MOSFET turns on again.

### 8.3.6 Thermal Shutdown

The junction temperature ( $T_J$ ) of the device is monitored by an internal temperature sensor. If  $T_J$  exceeds the thermal shutdown temperature  $T_{SD}$  of 160°C (typ), the device enters thermal shutdown. Both the high side and low side power FETs are turned off. When  $T_J$  decreases below the hysteresis amount of typically 20°C, the converter resumes operation, beginning with a soft start to the originally set  $V_{OUT}$  (there is no R2D conversion of  $R_{VSEL}$ ). The thermal shutdown is not active in Power Save Mode.

### 8.3.7 Output Voltage Discharge

The purpose of the output discharge function is to ensure a defined down-ramp of the output voltage when the device is disabled and to keep the output voltage close to 0 V. The output discharge feature is only active once the device has been enabled at least once since the supply voltage was applied. The output discharge function is not active if the device is disabled and the supply voltage is applied the first time.

The internal discharge resistor is connected to the VOS pin. The discharge function is enabled as soon as the device is disabled. The minimum supply voltage required to keep the discharge function active is  $V_{IN} > V_{TH\_UVLO}$ .

## 8.4 Device Functional Modes

### 8.4.1 Power Save Mode Operation

The DCS-Control™ topology supports Power Save Mode operation. At light loads the device operates in PFM (Pulse Frequency Modulation) mode that generates a single switching pulse to ramp up the inductor current and recharge the output capacitor, followed by a sleep period where most of the internal circuits are shutdown to achieve lowest operating quiescent current. During this time, the load current is supported by the output capacitor. The duration of the sleep period depends on the load current and the inductor peak current. During the sleep periods, the current consumption is reduced to typically 2.3  $\mu$ A. This low quiescent current consumption is achieved by an ultra low power voltage reference, an integrated high impedance feedback divider network and an optimized Power Save Mode operation.

In PFM Mode, the switching frequency varies linearly with the load current. At medium and high load conditions, the device enters automatically PWM (Pulse Width Modulation) mode and operates in continuous conduction mode with a nominal switch frequency  $f_{sw}$  of typically 4MHz or 1.5MHz. The switching frequency in PWM mode is controlled and depends on  $V_{IN}$  and  $V_{OUT}$ . The boundary between PWM and PFM mode is when the inductor current becomes discontinuous.

If the load current decreases, the converter seamlessly enters PFM mode to maintain high efficiency down to very light loads. Since DCS-Control™ supports both operation modes within one single building block, the transition from PWM to PFM Mode is seamless with minimum output voltage ripple.

### 8.4.2 Forced PWM Mode Operation

After the device has powered up and ramped up  $V_{OUT}$ , the VSEL/MODE pin acts as an input. With a high level on VSEL/MODE pin, the device enters forced PWM Mode and operates with a constant switching frequency over the entire load range, even at very light loads. This reduces or eliminates interference with RF and noise sensitive circuits, but lowers efficiency at light loads.

### 8.4.3 100% Mode Operation

The duty cycle of the buck converter operating in PWM mode is given as  $D = V_{OUT}/V_{IN}$ . The duty cycle increases as the input voltage comes close to the output voltage. In 100% duty cycle mode, it keeps the high side switch on continuously. The high side switch stays turned on as long as the output voltage is below the internal set point. This allows the conversion of small input to output voltage differences.

### 8.4.4 Optimized Transient Performance from PWM to PFM Mode Operation

For most converters, the load transient response in PWM mode is improved compared to PFM mode, since the converter reacts faster on the load step and actively sinks energy on the load release. Compare figure [Figure 43](#) and [Figure 42](#). As an additional feature, the TPS6280x automatically enters PWM mode for 16 cycles after a heavy load release in order to bring the output voltage back to the regulation level faster. After 16 cycles of PWM mode, it automatically returns to PFM mode (if VSEL/MODE is driven low). See [Figure 10](#). Without this optimization, the output voltage overshoot would be higher and would look like the  $V_{OUT}'$  trace. This feature is only active once the load is high enough and the converter operates in PWM mode.

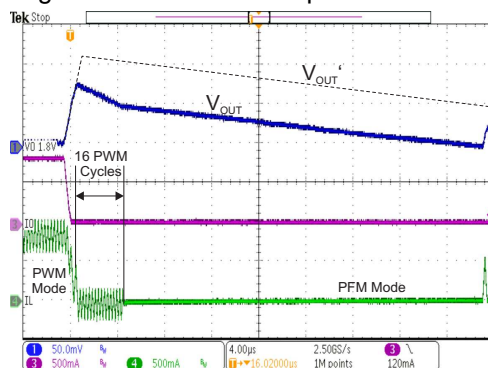

**Figure 10. Optimized Transient Performance from PWM to PFM Mode**

## 9 Application and Implementation

### NOTE

Information in the following applications sections is not part of the TI component specification, and TI does not warrant its accuracy or completeness. TI's customers are responsible for determining suitability of components for their purposes. Customers should validate and test their design implementation to confirm system functionality.

### 9.1 Application Information

The following section discusses the design of the external components to complete the power supply design for several input and output voltage options by using typical applications as a reference.

### 9.2 Typical Application

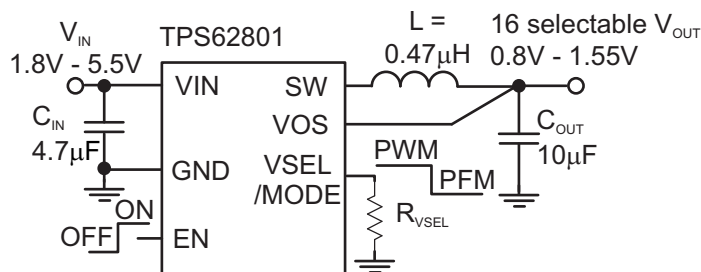

**Figure 11. TPS62801 Adjustable  $V_{OUT}$  Application Circuit**

Additional circuits are shown in the [System Examples](#) section.

#### 9.2.1 Design Requirements

[Table 2](#) shows the list of components for the application circuit and the characteristic application curves

**Table 2. Components for Application Characteristic Curves**

Reference	Description	Value	Size [L x W X T]	Manufacturer <sup>(1)</sup>
TPS62801 / 2	Step down converter		1.05mm x 0.70mm x 0.4mm max.	Texas Instruments
$C_{IN}$	Ceramic capacitor, GRM155R60J475ME47D	4.7 $\mu$ F	0402 (1mm x 0.5mm x 0.6mm max.)	Murata
$C_{OUT}$	Ceramic capacitor, GRM155R60J106ME15D	10 $\mu$ F	0402 (1mm x 0.5mm x 0.65mm max.)	Murata
L	Inductor DFE18SANR47MG0L	0.47 $\mu$ H	0603 (1.6mm x 0.8mm x 1.0mm max.)	Murata

(1) See [Third-party Products Disclaimer](#)

## 9.2.2 Detailed Design Procedure

### 9.2.2.1 Custom Design With WEBENCH® Tools

[Click here](#) to create a custom design using the TPS62800 device with the WEBENCH® Power Designer.

[Click here](#) to create a custom design using the TPS62801 device with the WEBENCH® Power Designer.

[Click here](#) to create a custom design using the TPS62802 device with the WEBENCH® Power Designer.

[Click here](#) to create a custom design using the TPS62806 device with the WEBENCH® Power Designer.

[Click here](#) to create a custom design using the TPS62807 device with the WEBENCH® Power Designer.

[Click here](#) to create a custom design using the TPS62808 device with the WEBENCH® Power Designer.

1. Start by entering the input voltage ( $V_{IN}$ ), output voltage ( $V_{OUT}$ ), and output current ( $I_{OUT}$ ) requirements.
2. Optimize the design for key parameters such as efficiency, footprint, and cost using the optimizer dial.
3. Compare the generated design with other possible solutions from Texas Instruments.

The WEBENCH Power Designer provides a customized schematic along with a list of materials with real-time pricing and component availability.

In most cases, these actions are available:

- Run electrical simulations to see important waveforms and circuit performance
- Run thermal simulations to understand board thermal performance
- Export customized schematic and layout into popular CAD formats
- Print PDF reports for the design, and share the design with colleagues

Get more information about WEBENCH tools at [www.ti.com/WEBENCH](http://www.ti.com/WEBENCH).

### 9.2.2.2 Inductor Selection

The inductor value affects the peak-to-peak ripple current, the PWM-to-PFM transition point, the output voltage ripple and the efficiency. The selected inductor has to be rated for its DC resistance and saturation current. The inductor ripple current ( $\Delta I_L$ ) decreases with higher inductance and increases with higher  $V_{IN}$  or  $V_{OUT}$  and can be estimated according to [Equation 1](#).

[Equation 2](#) calculates the maximum inductor current under static load conditions. The saturation current of the inductor should be rated higher than the maximum inductor current, as calculated with [Equation 2](#). This is recommended because during a heavy load transient the inductor current rises above the calculated value. A more conservative way is to select the inductor saturation current according to the high side MOSFET switch current limit,  $I_{LIMF}$ .

$$\Delta I_L = V_{out} \times \frac{1 - \frac{V_{out}}{V_{in}}}{L \times f} \quad (1)$$

$$I_{Lmax} = I_{outmax} + \frac{\Delta I_L}{2}$$

where

- $f$  = Switching Frequency
  - $L$  = Inductor Value
  - $\Delta I_L$  = Peak to Peak inductor ripple current
  - $I_{Lmax}$  = Maximum Inductor current
- (2)



Table 3 shows a list of possible inductors.

**Table 3. List of Possible Inductors<sup>(1)</sup>**

INDUCTANCE [ $\mu$ H]	INDUCTOR SERIES	SIZE IMPERIAL (METRIC)	DIMENSIONS L x W x T	SUPPLIER <sup>(1)</sup>
0.47	DFE18SAN_G0	0603 (1608)	1.6mm x 0.8mm x 1.0mm max	Murata
0.47	HTEB16080F	0603 (1608)	1.6mm x 0.8mm x 0.6mm max.	Cyntec
0.47	HTET1005FE	0402 (1005)	1.0mm x 0.5mm x 0.65mm max.	Cyntec
0.47	TFM160808ALC	0603 (1608)	1.6mm x 0.8mm x 0.8mm max.	TDK
1.0	DFE201610E	0806 (201610)	2.0mm x 1.6mm x 1.0mm max	Murata

(1) See [Third-party Products Disclaimer](#)

### 9.2.2.3 Output Capacitor Selection

The DCS-Control™ scheme of the TPS6280x allows the use of tiny ceramic capacitors. Ceramic capacitors with low ESR values have the lowest output voltage ripple and are recommended. The output capacitor requires either an X7R or X5R dielectric. At light load currents, the converter operates in Power Save Mode and the output voltage ripple is dependent on the output capacitor value. A larger output capacitors can be used reducing the output voltage ripple.

The inductor and output capacitor together provide a low-pass filter. To simplify this process, [Table 4](#) outlines possible inductor and capacitor value combinations.

**Table 4. Recommended LC Output Filter Combinations**

Device	Nominal Inductor Value [ $\mu$ H]	Nominal Output Capacitor Value [ $\mu$ F]			
		4.7 $\mu$ F	10 $\mu$ F	2 x 10 $\mu$ F	22 $\mu$ F
TPS62800, TPS62801	0.47 <sup>(1)</sup>	√	√ <sup>(2)</sup>	√	√
TPS62802	0.47 <sup>(1)</sup>		√ <sup>(2)</sup>	√	√
TPS62806, TPS62807, TPS62808	1.0 <sup>(3)</sup>	√	√ <sup>(2)</sup>	√	√

(1) An effective inductance range of 0.33  $\mu$ H to 0.82  $\mu$ H is recommended. An effective capacitance range of 2  $\mu$ F to 26 $\mu$ F is recommended.

(2) Typical application configuration. Other check marks indicate alternative filter combinations.

(3) An effective inductance range of 0.7  $\mu$ H to 1.2  $\mu$ H is recommended. An effective capacitance range of 3  $\mu$ F to 26  $\mu$ F is recommended.

### 9.2.2.4 Input Capacitor Selection

Because the buck converter has a pulsating input current, a low ESR ceramic input capacitor is required for best input voltage filtering to minimize input voltage spikes. For most applications a 4.7- $\mu$ F input capacitor is sufficient. When operating from a high impedance source, like a coin cell, a larger input buffer capacitor  $\geq 10\mu$ F is recommended to avoid voltage drops during startup and load transients. The input capacitor can be increased without any limit for better input voltage filtering. The leakage current of the input capacitor adds to the overall current consumption.

[Table 5](#) shows a selection of input and output capacitors.

**Table 5. List of Possible Capacitors<sup>(1)</sup>**

CAPACITANCE [ $\mu$ F]	CAPACITOR PART NUMBER	SIZE IMPERIAL (METRIC)	DIMENSIONS L x W x T	SUPPLIER <sup>(1)</sup>
4.7	GRM155R60J475ME47D	0402 (1005)	1.0mm x 0.5mm x 0.6mm max.	Murata
4.7	GRM035R60J475ME15	0201 (0603)	0.6mm x 0.3mm x 0.55mm max	Murata
10	GRM155R60J106ME15D	0402 (1005)	1.0mm x 0.5mm x 0.65mm max.	Murata

(1) See [Third-party Products Disclaimer](#)



### 9.2.3 Application Curves

The conditions for the below application curves are  $V_{IN} = 3.6\text{ V}$ ,  $V_{OUT} = 1.2\text{ V}$  and the components listed in Table 2, unless otherwise noted.

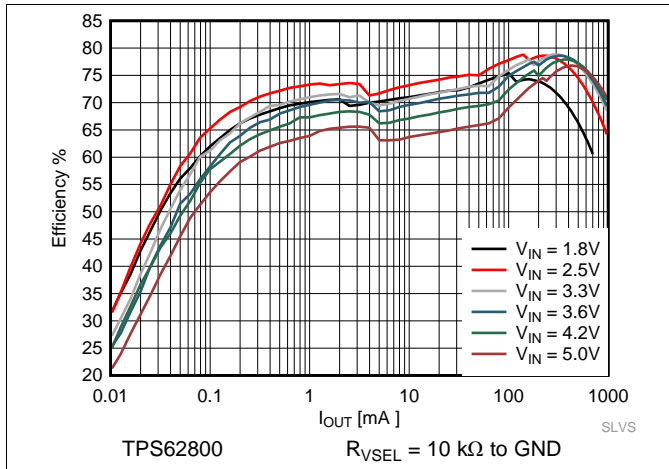

Figure 12. Efficiency Power Save Mode  $V_{OUT} = 0.4\text{ V}$

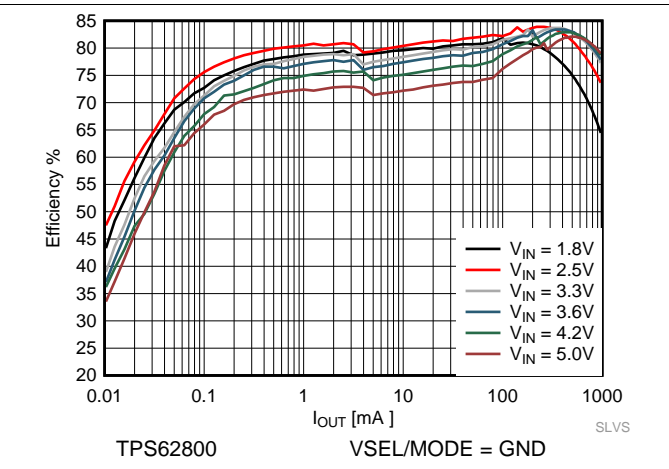

Figure 13. Efficiency Power Save Mode  $V_{OUT} = 0.7\text{ V}$

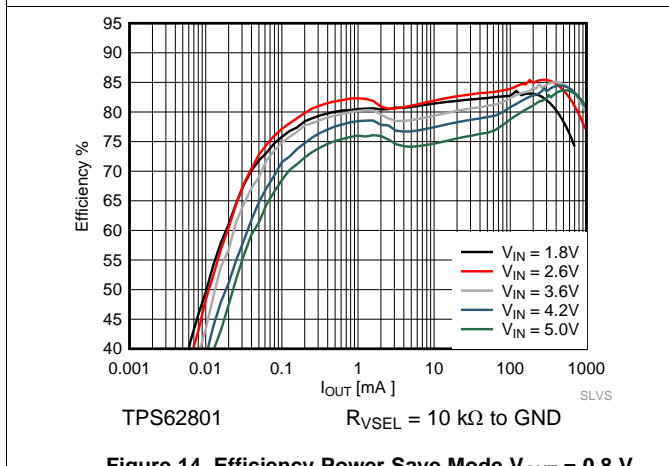

Figure 14. Efficiency Power Save Mode  $V_{OUT} = 0.8\text{ V}$

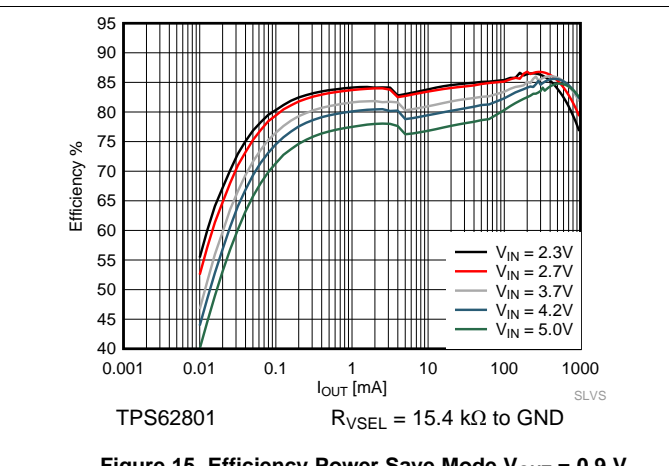

Figure 15. Efficiency Power Save Mode  $V_{OUT} = 0.9\text{ V}$

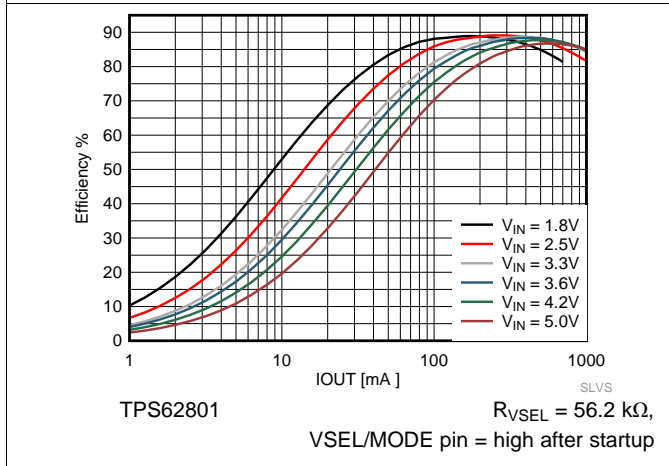

Figure 16. Efficiency Forced PWM Mode  $V_{OUT} = 1.2\text{ V}$

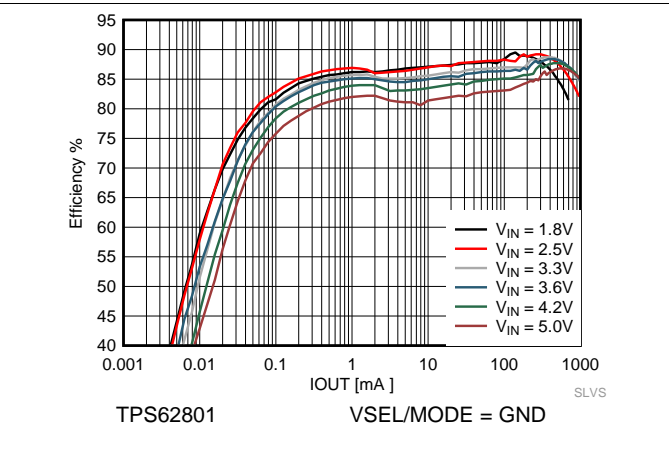

Figure 17. Efficiency Power Save Mode  $V_{OUT} = 1.2\text{ V}$

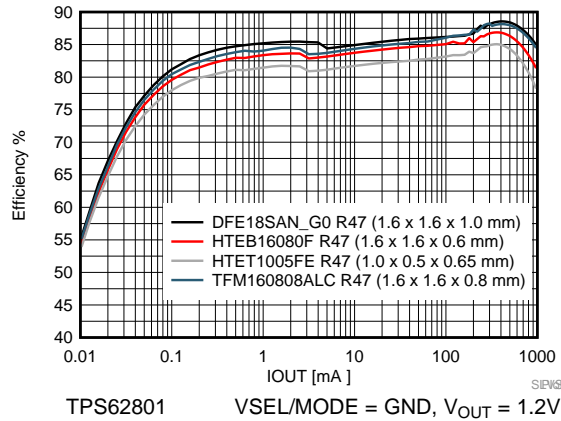

Figure 18. Inductor Comparison

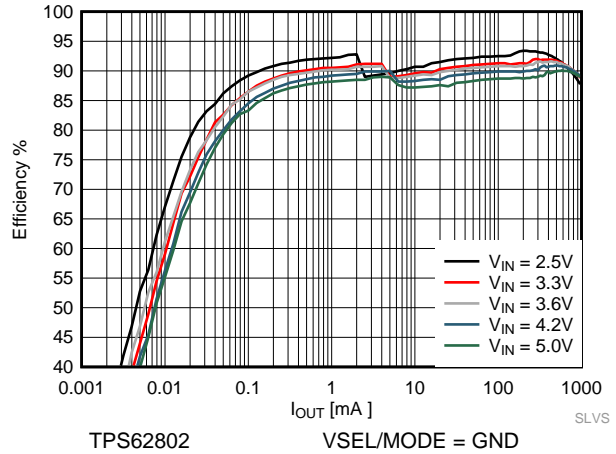

Figure 19. Efficiency Power Save Mode  $V_{OUT} = 1.8\text{ V}$

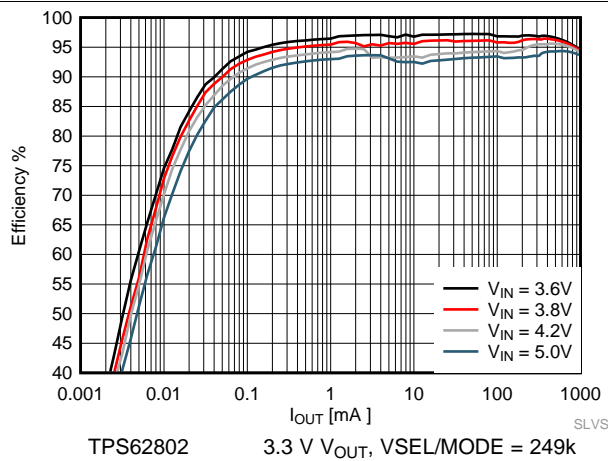

Figure 20. Efficiency Power Save Mode  $V_{OUT} = 3.3\text{ V}$

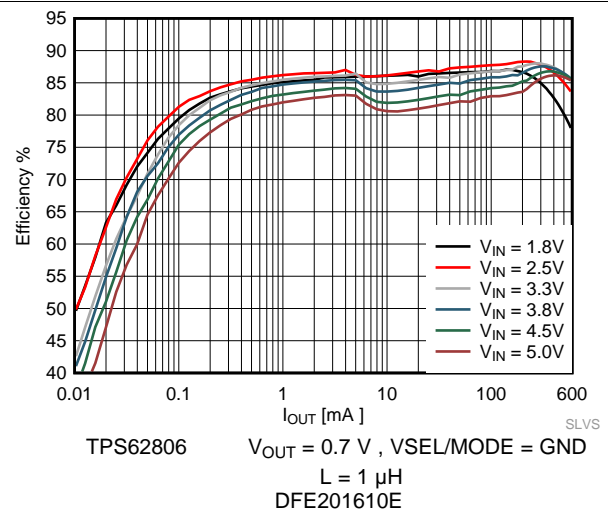

Figure 21. Efficiency Power Save Mode  $V_{OUT} = 0.7\text{ V}$

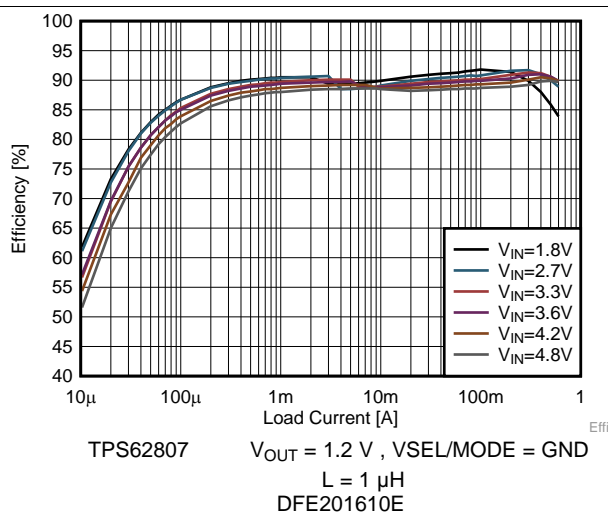

Figure 22. Efficiency Power Save Mode  $V_{OUT} = 1.2\text{ V}$

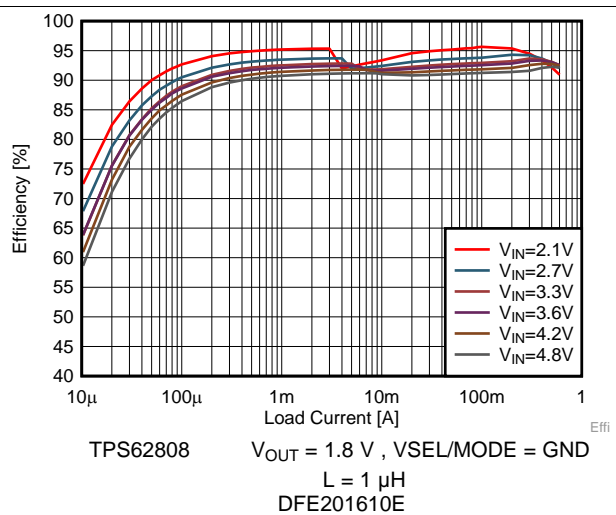

Figure 23. Efficiency Power Save Mode  $V_{OUT} = 1.8\text{ V}$

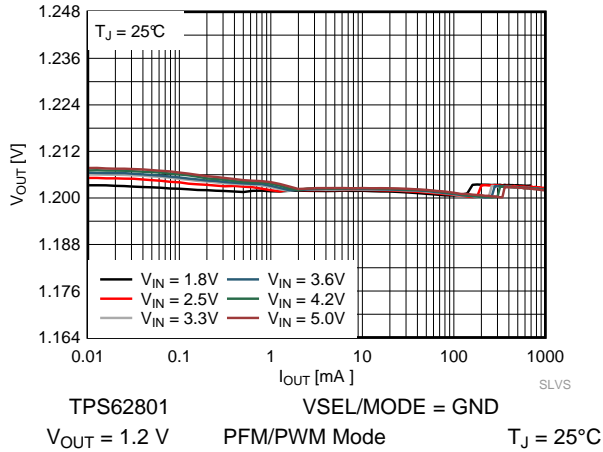

Figure 24. Output Voltage vs. Output Current

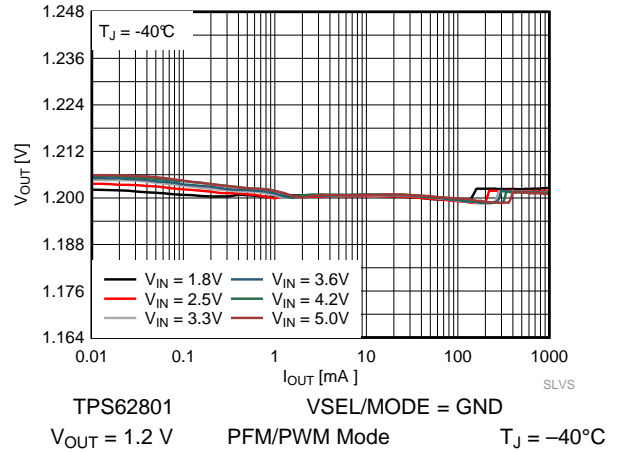

Figure 25. Output Voltage vs. Output Current

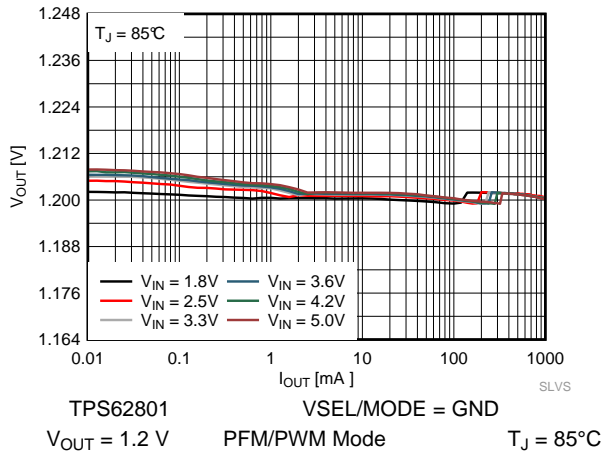

Figure 26. Output Voltage vs. Output Current

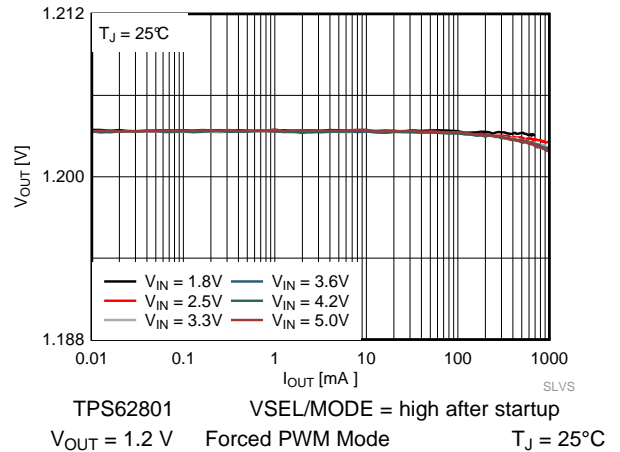

Figure 27. Output Voltage vs. Output Current

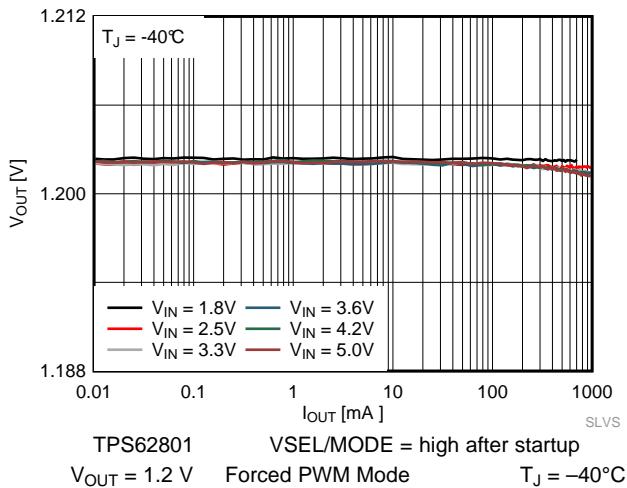

Figure 28. Output Voltage vs. Output Current

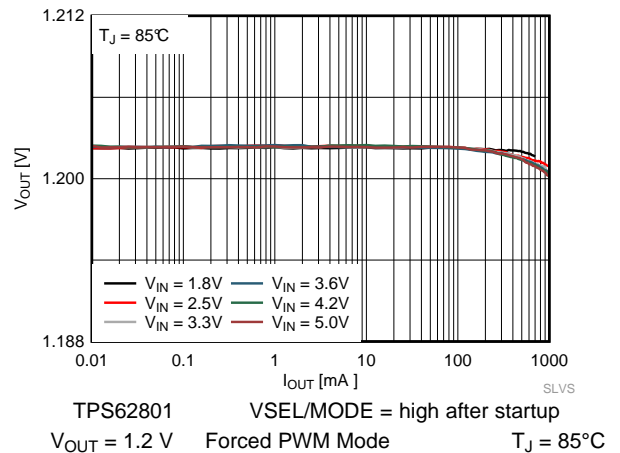

Figure 29. Output Voltage vs. Output Current

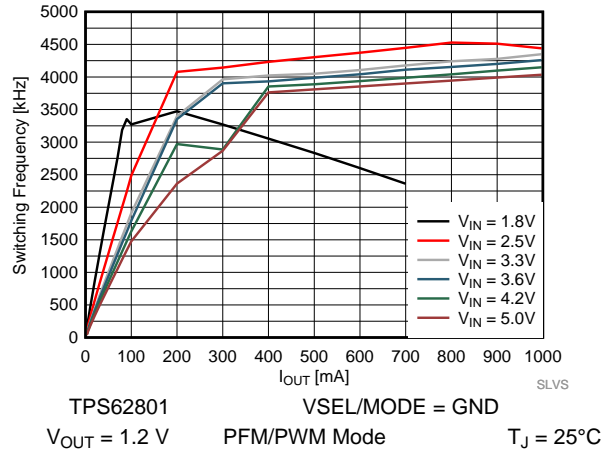

Figure 30. Switching Frequency vs. Output Current

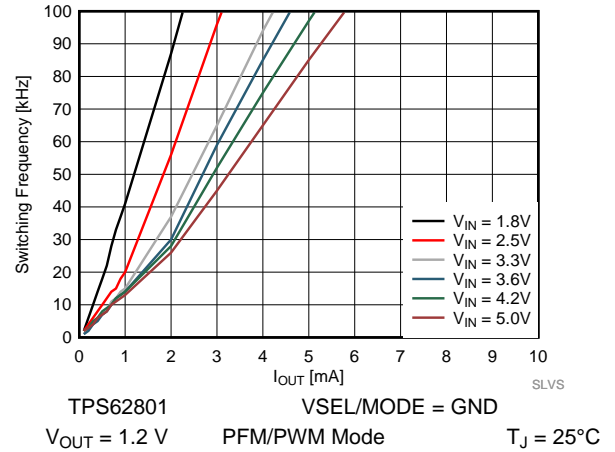

Figure 31. Switching Frequency (zoom in)

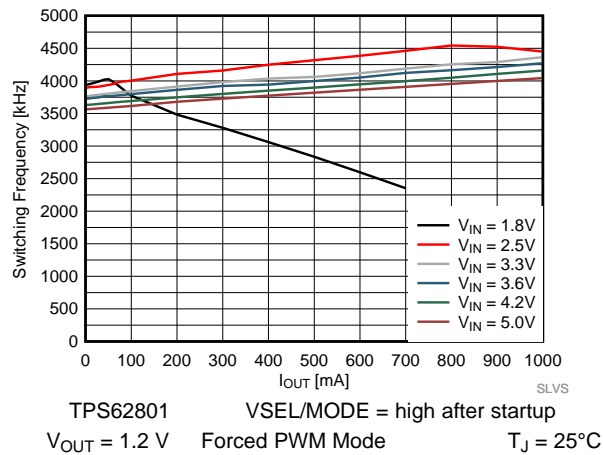

Figure 32. Switching Frequency vs. Output Current

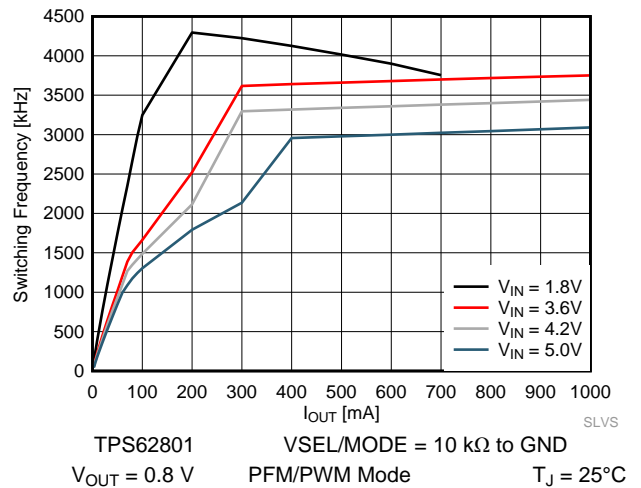

Figure 33. Switching Frequency vs. Output Current

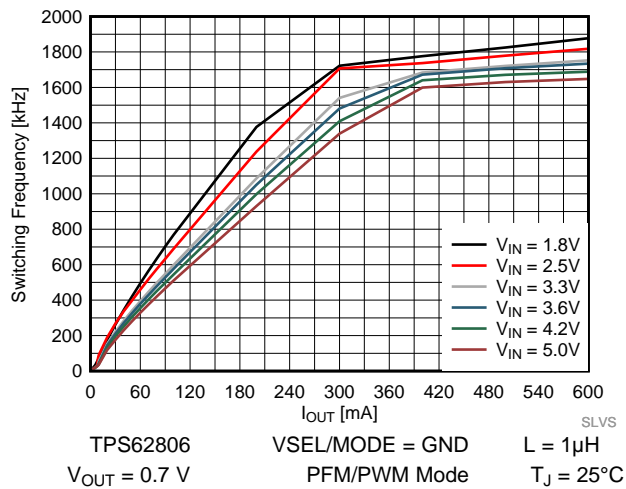

Figure 34. Switching Frequency vs. Output Current

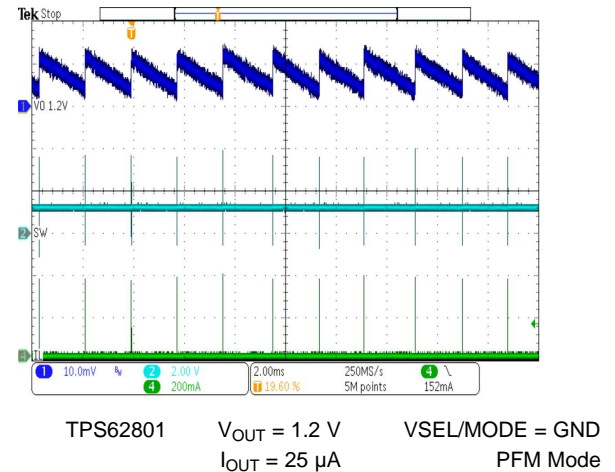
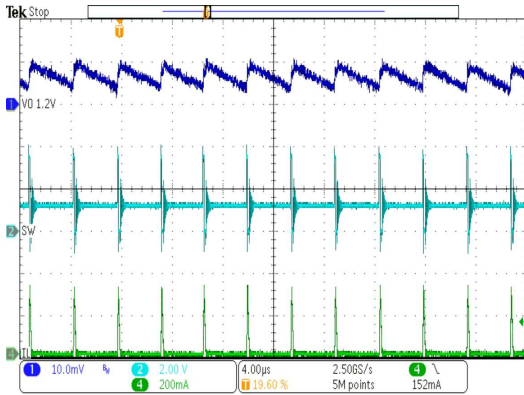
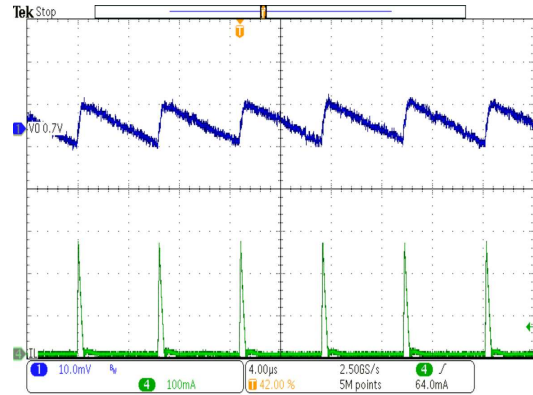

Figure 35. Typical Operation Power Save Mode



TPS62801  $V_{OUT} = 1.2\text{ V}$   $V_{SEL}/MODE = GND$   
 $I_{OUT} = 10\text{ mA}$  PFM Mode

Figure 36. Typical Operation Power Save Mode



TPS62806  $V_{OUT} = 0.7\text{ V}$   $V_{SEL}/MODE = GND$   
 $V_{IN} = 3.8\text{ V}$   $I_{OUT} = 10\text{ mA}$  PFM Mode,  $L = 1\mu\text{H}$   
 DFE201610E

Figure 37. TPS62806 Typical operation Power Save Mode

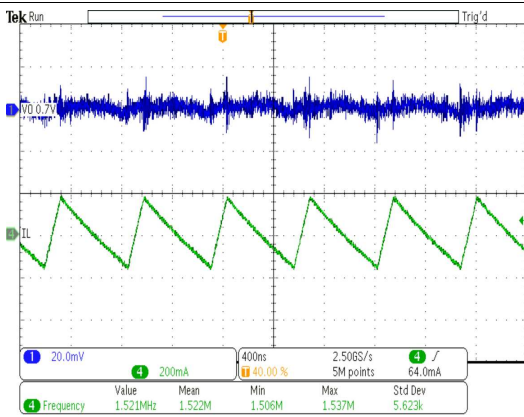

TPS62806  $V_{OUT} = 0.7\text{ V}$   $V_{SEL}/MODE = V_{IN}$  (after startup)  
 $V_{IN} = 3.8\text{ V}$   $I_{OUT} = 0\text{ mA}$  PFM Mode,  $L = 1\mu\text{H}$   
 DFE201610E

Figure 38. TPS62806 typical forced PWM mode operation (1.5MHz)

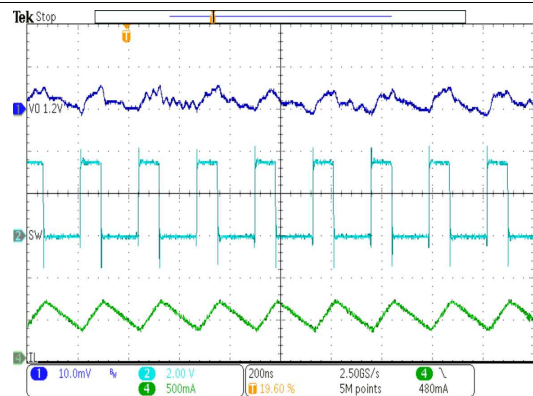

TPS62801  $V_{OUT} = 1.2\text{ V}$   $V_{SEL}/MODE = GND$   
 $I_{OUT} = 500\text{ mA}$  PWM Mode

Figure 39. Typical Operation PWM Mode

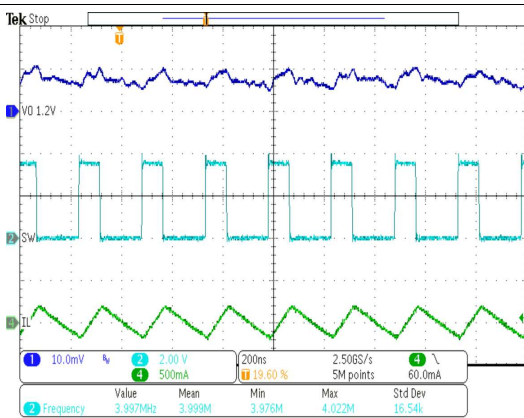

TPS62801  $V_{OUT} = 1.2\text{ V}$   $I_{OUT} = 0\text{ mA}$   
 Forced PWM Mode  $V_{SEL}/MODE = V_{IN}$  (after startup)

Figure 40. Typical Operation Forced PWM Mode

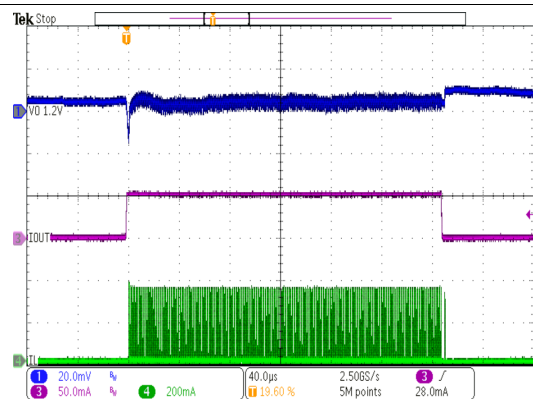

TPS62801  $V_{OUT} = 1.2\text{ V}$   $V_{SEL}/MODE = GND$   
 rise / fall time < 1  $\mu\text{s}$   $I_{OUT} = 0\text{ mA}$  to 50 mA, PFM Mode

Figure 41. Load Transient Power Save Mode

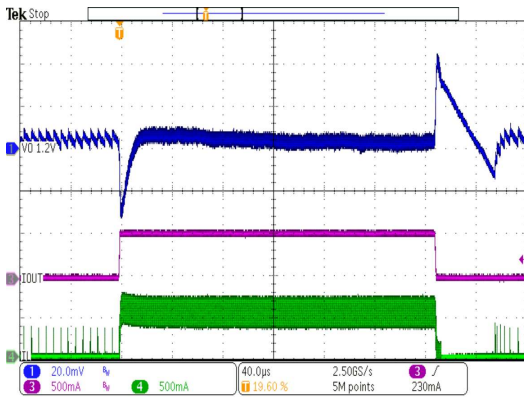

TPS62801  $V_{OUT} = 1.2\text{ V}$   $VSEL/MODE = \text{GND}$   
 rise / fall time  $< 1\ \mu\text{s}$  PFM / PWM Mode  
 $I_{OUT} = 5\text{ mA to } 500\text{ mA}$

Figure 42. Load Transient Power Save Mode

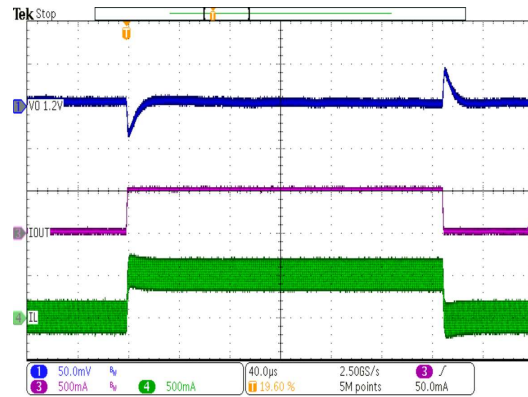

TPS62801  $V_{OUT} = 1.2\text{ V}$   $VSEL/MODE = \text{VIN}$   
 rise / fall time  $< 1\ \mu\text{s}$  (after startup)  
 Forced PWM Mode  $I_{OUT} = 5\text{ mA to } 500\text{ mA}$

Figure 43. Load Transient Forced PWM Mode

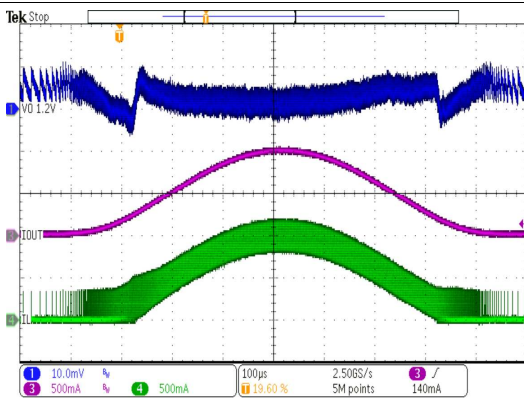

TPS62801  $V_{OUT} = 1.2\text{ V}$   $VSEL/MODE = \text{GND}$   
 $I_{OUT} = 1\text{ mA to } 1\text{ A}$  1 kHz PFM/PWM Mode

Figure 44. AC Load Sweep Power Save Mode

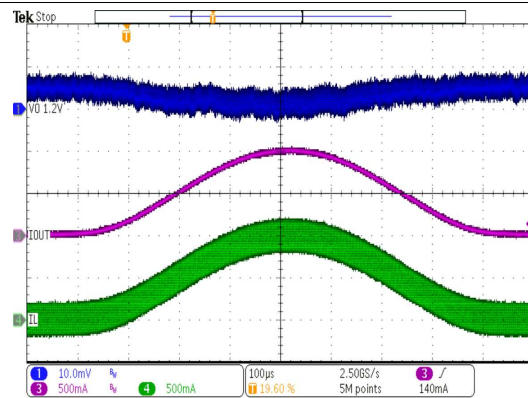

TPS62801  $V_{OUT} = 1.2\text{ V}$   $VSEL/MODE = \text{VIN}$   
 $I_{OUT} = 1\text{ mA to } 1\text{ A}$ , 1 kHz (after startup)  
 Forced PWM Mode

Figure 45. AC Load Sweep Forced PWM Mode

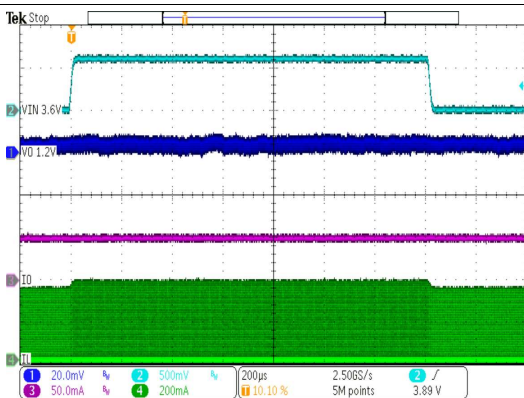

TPS62801  $V_{OUT} = 1.2\text{ V}$   $V_{IN} = 3.6\text{ V to } 4.2\text{ V}$   
 rise / fall time =  $10\ \mu\text{s}$   $I_{OUT} = 50\text{ mA}$

Figure 46. Line Transient PFM Mode

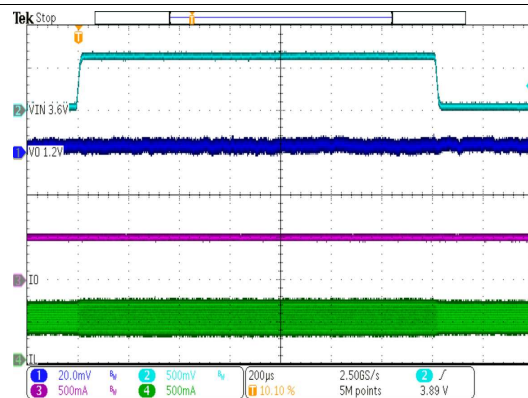

TPS62801  $V_{OUT} = 1.2\text{ V}$   $V_{IN} = 3.6\text{ V to } 4.2\text{ V}$   
 rise / fall time =  $10\ \mu\text{s}$   $I_{OUT} = 500\text{ mA}$

Figure 47. Line Transient PWM Mode



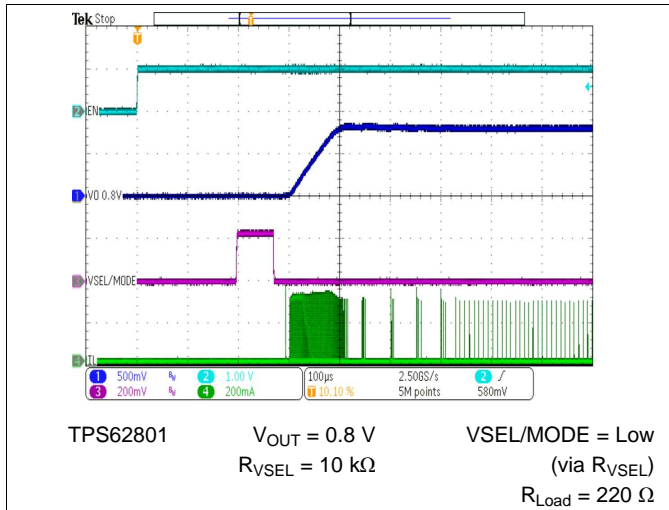

Figure 48. Startup  $V_{OUT} = 0.8\text{ V}$

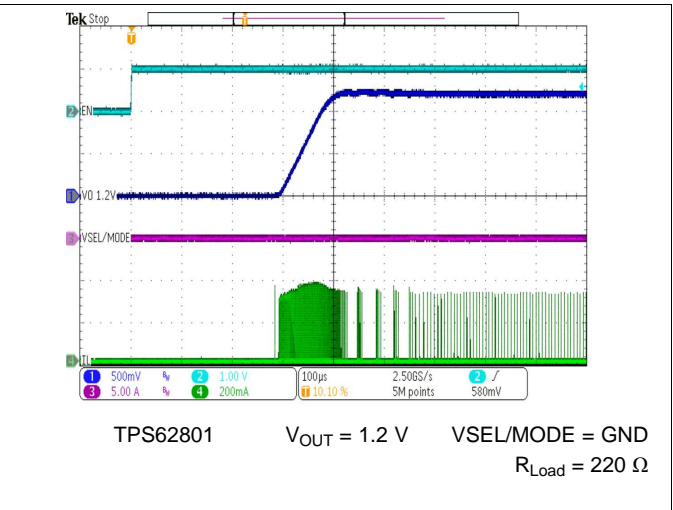

Figure 49. Startup  $V_{OUT} = 1.2\text{ V}$

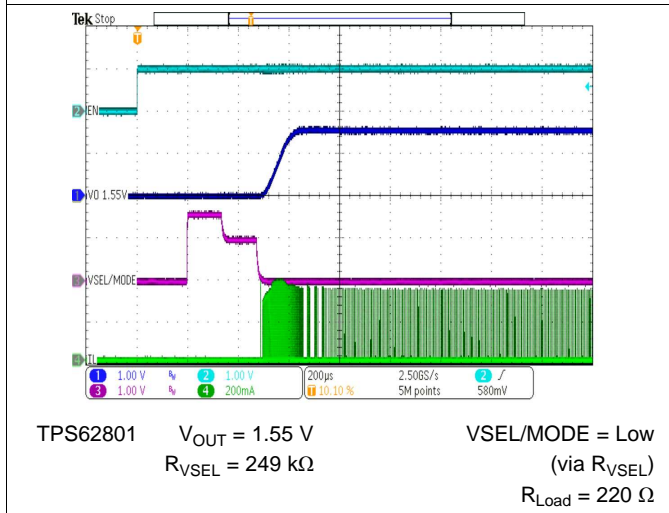

Figure 50. Startup  $V_{OUT} = 1.55\text{ V}$

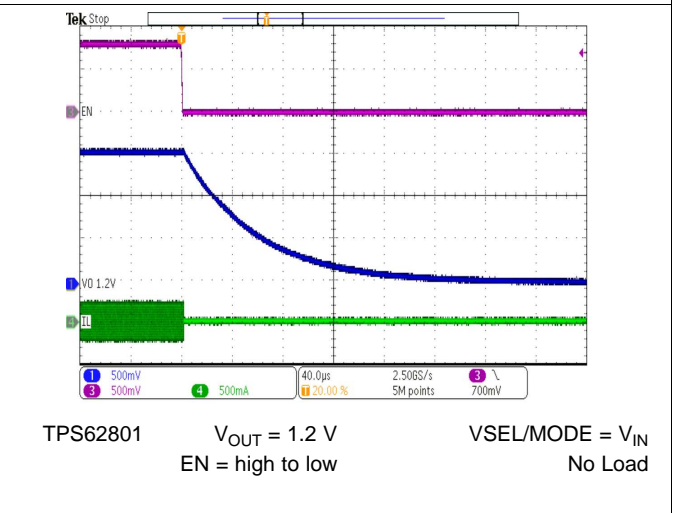

Figure 51. Output Discharge

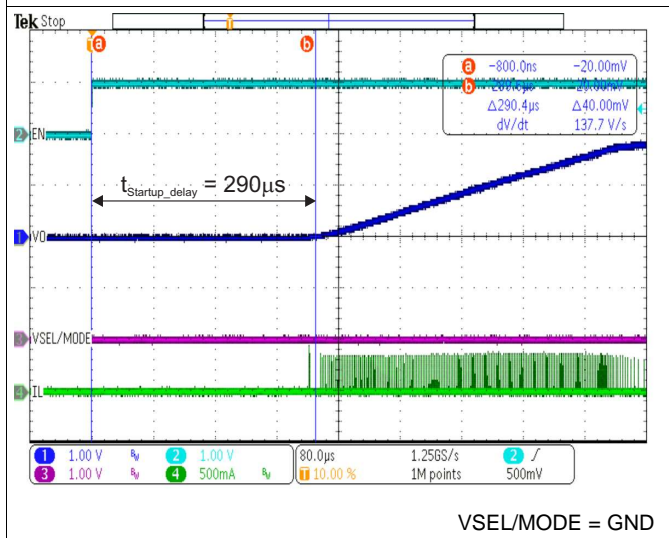

Figure 52. Startup Delay Time,  $VSEL = 0$

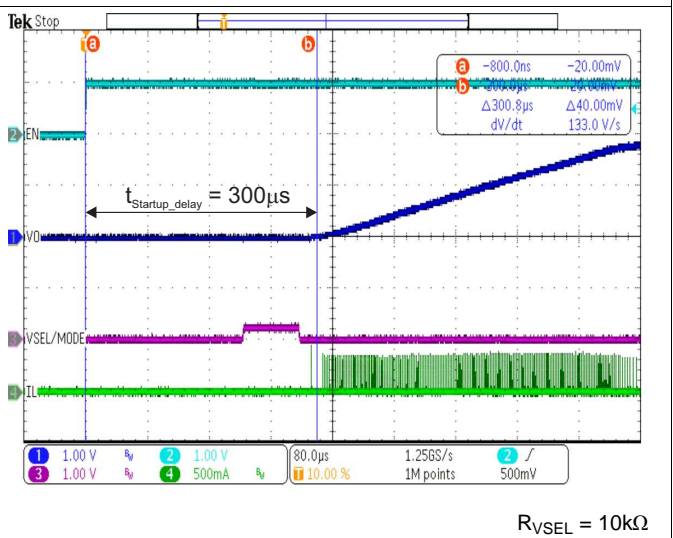
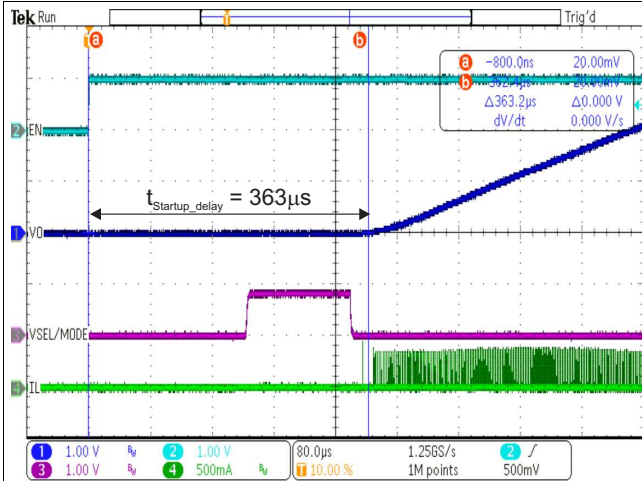
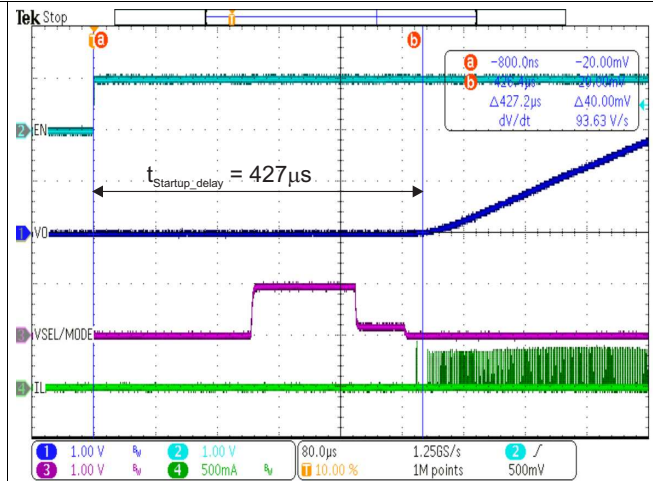

Figure 53. Startup Delay Time,  $VSEL = 1$



$R_{VSEL} = 36.5k\Omega$

Figure 54. Startup Delay Time, VSEL = 7



$R_{VSEL} = 44.2k\Omega$

Figure 55. Startup Delay Time, VSEL = 8

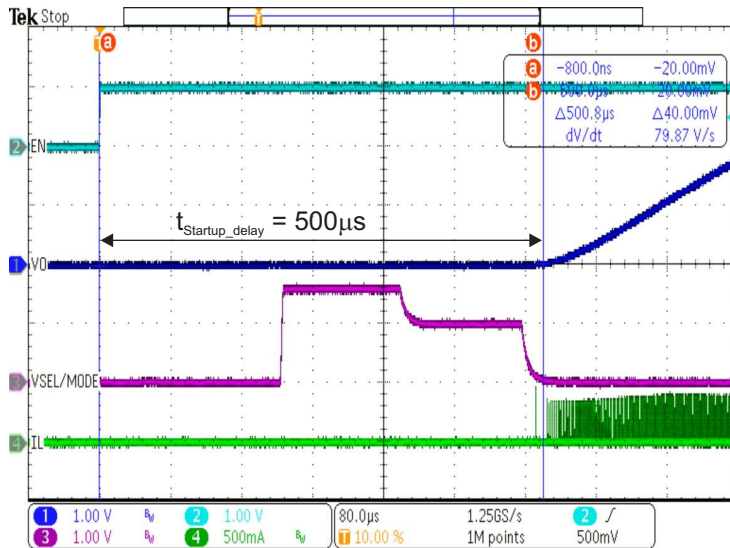

$R_{VSEL} = 249k\Omega$

Figure 56. Startup Delay Time, VSEL = 16



### 9.3 System Examples

This section shows additional circuits for various output voltages.

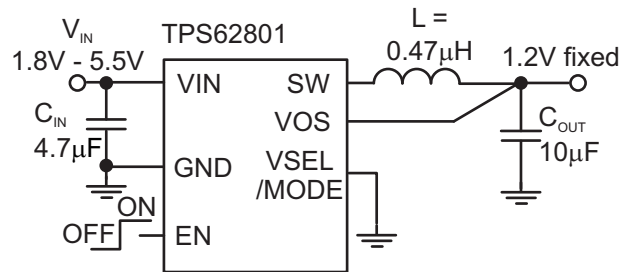

Copyright © 2017, Texas Instruments Incorporated

Figure 57. TPS62801 VSEL Connected to GND for 1.2V Fixed  $V_{OUT}$

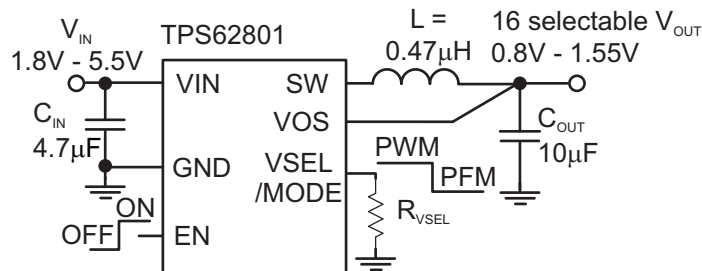

Figure 58. TPS62801 Adjustable  $V_{OUT}$  Application Circuit

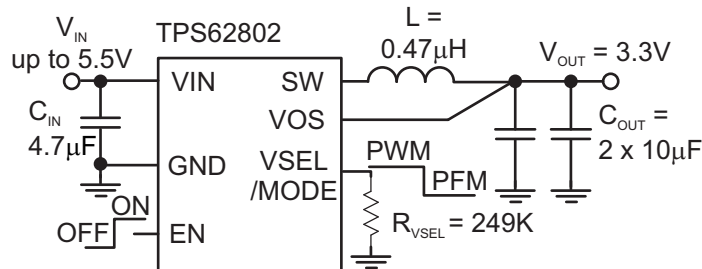
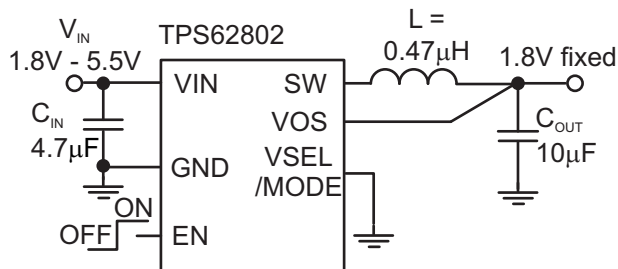

Figure 59. TPS62802 Adjustable 3.3V  $V_{OUT}$  Application Circuit



Copyright © 2017, Texas Instruments Incorporated

Figure 60. TPS62802 VSEL Connected to GND for 1.8V Fixed  $V_{OUT}$

**System Examples (continued)**

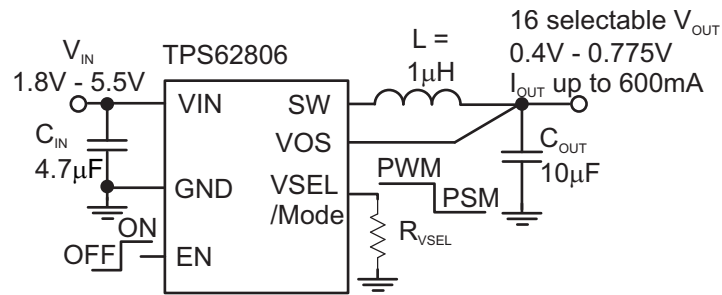

**Figure 61. TPS62806 Adjustable  $V_{OUT}$  Application Circuit**

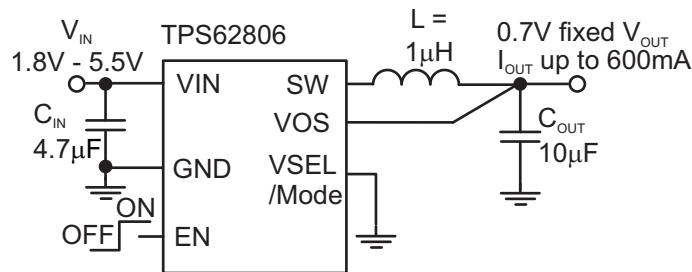

**Figure 62. TPS62806 VSEL Connected to GND for 0.7V Fixed  $V_{OUT}$**

## 10 Power Supply Recommendations

The power supply must provide a current rating according to the supply voltage, output voltage and output current of the TPS6280x.

## 11 Layout

### 11.1 Layout Guidelines

The pinout of TPS6280x has been optimized to enable a single top layer PCB routing of the IC and its critical passive components such as  $C_{IN}$ ,  $C_{OUT}$  and L. Furthermore, this pin out allows to connect tiny components such as 0201 (0603) size capacitors and 0402 (1005) size inductor. A solution size smaller than  $5\text{mm}^2$  can be achieved with a fixed output voltage.

- As for all switching power supplies, the layout is an important step in the design. Care must be taken in board layout to get the specified performance.
- It is critical to provide a low inductance, low impedance ground path. Therefore, use wide and short traces for the main current paths.
- The input capacitor should be placed as close as possible to the IC's VIN and GND pins. This is the most critical component placement.
- The VOS line is a sensitive, high impedance line and should be connected to the output capacitor and routed away from noisy components and traces (e.g. SW line) or other noise sources.

### 11.2 Layout Example

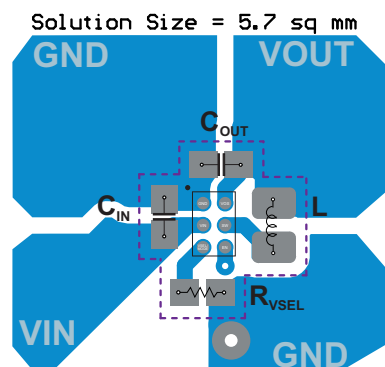

**Figure 63. PCB Layout Example**

## 12 Device and Documentation Support

### 12.1 Device Support

#### 12.1.1 Third-Party Products Disclaimer

TI'S PUBLICATION OF INFORMATION REGARDING THIRD-PARTY PRODUCTS OR SERVICES DOES NOT CONSTITUTE AN ENDORSEMENT REGARDING THE SUITABILITY OF SUCH PRODUCTS OR SERVICES OR A WARRANTY, REPRESENTATION OR ENDORSEMENT OF SUCH PRODUCTS OR SERVICES, EITHER ALONE OR IN COMBINATION WITH ANY TI PRODUCT OR SERVICE.

#### 12.2 Custom Design With WEBENCH® Tools

[Click here](#) to create a custom design using the TPS62800 device with the WEBENCH® Power Designer.

[Click here](#) to create a custom design using the TPS62801 device with the WEBENCH® Power Designer.

[Click here](#) to create a custom design using the TPS62802 device with the WEBENCH® Power Designer.

[Click here](#) to create a custom design using the TPS62806 device with the WEBENCH® Power Designer.

1. Start by entering the input voltage ( $V_{IN}$ ), output voltage ( $V_{OUT}$ ), and output current ( $I_{OUT}$ ) requirements.
2. Optimize the design for key parameters such as efficiency, footprint, and cost using the optimizer dial.
3. Compare the generated design with other possible solutions from Texas Instruments.

The WEBENCH Power Designer provides a customized schematic along with a list of materials with real-time pricing and component availability.

In most cases, these actions are available:

- Run electrical simulations to see important waveforms and circuit performance
- Run thermal simulations to understand board thermal performance
- Export customized schematic and layout into popular CAD formats
- Print PDF reports for the design, and share the design with colleagues

Get more information about WEBENCH tools at [www.ti.com/WEBENCH](http://www.ti.com/WEBENCH).

### 12.3 Related Links

The table below lists quick access links. Categories include technical documents, support and community resources, tools and software, and quick access to order now.

**Table 6. Related Links**

PARTS	PRODUCT FOLDER	ORDER NOW	TECHNICAL DOCUMENTS	TOOLS & SOFTWARE	SUPPORT & COMMUNITY
TPS62800	<a href="#">Click here</a>	<a href="#">Click here</a>	<a href="#">Click here</a>	<a href="#">Click here</a>	<a href="#">Click here</a>
TPS62801	<a href="#">Click here</a>	<a href="#">Click here</a>	<a href="#">Click here</a>	<a href="#">Click here</a>	<a href="#">Click here</a>
TPS62802	<a href="#">Click here</a>	<a href="#">Click here</a>	<a href="#">Click here</a>	<a href="#">Click here</a>	<a href="#">Click here</a>
TPS62806	<a href="#">Click here</a>	<a href="#">Click here</a>	<a href="#">Click here</a>	<a href="#">Click here</a>	<a href="#">Click here</a>
TPS62807	<a href="#">Click here</a>	<a href="#">Click here</a>	<a href="#">Click here</a>	<a href="#">Click here</a>	<a href="#">Click here</a>
TPS62808	<a href="#">Click here</a>	<a href="#">Click here</a>	<a href="#">Click here</a>	<a href="#">Click here</a>	<a href="#">Click here</a>

### 12.4 Community Resources

The following links connect to TI community resources. Linked contents are provided "AS IS" by the respective contributors. They do not constitute TI specifications and do not necessarily reflect TI's views; see TI's [Terms of Use](#).

**TI E2E™ Online Community** *TI's Engineer-to-Engineer (E2E) Community*. Created to foster collaboration among engineers. At [e2e.ti.com](http://e2e.ti.com), you can ask questions, share knowledge, explore ideas and help solve problems with fellow engineers.

**Design Support** *TI's Design Support* Quickly find helpful E2E forums along with design support tools and

## Community Resources (continued)

contact information for technical support.

### 12.5 Trademarks

DCS-Control, E2E are trademarks of Texas Instruments.

Topology is a trademark of others.

All other trademarks are the property of their respective owners.

### 12.6 Electrostatic Discharge Caution



These devices have limited built-in ESD protection. The leads should be shorted together or the device placed in conductive foam during storage or handling to prevent electrostatic damage to the MOS gates.

### 12.7 Glossary

[SLYZ022](#) — *TI Glossary*.

This glossary lists and explains terms, acronyms, and definitions.

## 13 Mechanical, Packaging, and Orderable Information

The following pages include mechanical, packaging, and orderable information. This information is the most current data available for the designated devices. This data is subject to change without notice and revision of this document. For browser-based versions of this data sheet, refer to the left-hand navigation.

**PACKAGING INFORMATION**

Orderable Device	Status (1)	Package Type	Package Drawing	Pins	Package Qty	Eco Plan (2)	Lead/Ball Finish (6)	MSL Peak Temp (3)	Op Temp (°C)	Device Marking (4/5)	Samples
TPS62800YKAR	ACTIVE	DSBGA	YKA	6	3000	Green (RoHS & no Sb/Br)	Call TI	Level-1-260C-UNLIM	-40 to 125	-	<a href="#">Samples</a>
TPS62800YKAT	ACTIVE	DSBGA	YKA	6	250	Green (RoHS & no Sb/Br)	Call TI	Level-1-260C-UNLIM	-40 to 125	-	<a href="#">Samples</a>
TPS62801YKAR	ACTIVE	DSBGA	YKA	6	3000	Green (RoHS & no Sb/Br)	SAC396	Level-1-260C-UNLIM	-40 to 125	+	<a href="#">Samples</a>
TPS62801YKAT	ACTIVE	DSBGA	YKA	6	250	Green (RoHS & no Sb/Br)	SAC396	Level-1-260C-UNLIM	-40 to 125	+	<a href="#">Samples</a>
TPS62802YKAR	ACTIVE	DSBGA	YKA	6	3000	Green (RoHS & no Sb/Br)	SAC396	Level-1-260C-UNLIM	-40 to 125	X	<a href="#">Samples</a>
TPS62802YKAT	ACTIVE	DSBGA	YKA	6	250	Green (RoHS & no Sb/Br)	SAC396	Level-1-260C-UNLIM	-40 to 125	X	<a href="#">Samples</a>
TPS62806YKAR	ACTIVE	DSBGA	YKA	6	3000	Green (RoHS & no Sb/Br)	Call TI	Level-1-260C-UNLIM	-40 to 125	J	<a href="#">Samples</a>
TPS62806YKAT	ACTIVE	DSBGA	YKA	6	250	Green (RoHS & no Sb/Br)	Call TI	Level-1-260C-UNLIM	-40 to 125	J	<a href="#">Samples</a>
TPS62807YKAR	PREVIEW	DSBGA	YKA	6	3000	Green (RoHS & no Sb/Br)	Call TI	Level-1-260C-UNLIM	-40 to 125	L	
TPS62807YKAT	PREVIEW	DSBGA	YKA	6	250	Green (RoHS & no Sb/Br)	Call TI	Level-1-260C-UNLIM	-40 to 125	L	
TPS62808YKAR	PREVIEW	DSBGA	YKA	6	3000	Green (RoHS & no Sb/Br)	Call TI	Level-1-260C-UNLIM	-40 to 125	V	
TPS62808YKAT	PREVIEW	DSBGA	YKA	6	250	Green (RoHS & no Sb/Br)	Call TI	Level-1-260C-UNLIM	-40 to 125	V	

(1) The marketing status values are defined as follows:

**ACTIVE:** Product device recommended for new designs.

**LIFEBUY:** TI has announced that the device will be discontinued, and a lifetime-buy period is in effect.

**NRND:** Not recommended for new designs. Device is in production to support existing customers, but TI does not recommend using this part in a new design.

**PREVIEW:** Device has been announced but is not in production. Samples may or may not be available.

**OBSELETE:** TI has discontinued the production of the device.

(2) **RoHS:** TI defines "RoHS" to mean semiconductor products that are compliant with the current EU RoHS requirements for all 10 RoHS substances, including the requirement that RoHS substance do not exceed 0.1% by weight in homogeneous materials. Where designed to be soldered at high temperatures, "RoHS" products are suitable for use in specified lead-free processes. TI may reference these types of products as "Pb-Free".

**RoHS Exempt:** TI defines "RoHS Exempt" to mean products that contain lead but are compliant with EU RoHS pursuant to a specific EU RoHS exemption.

---

**Green:** TI defines "Green" to mean the content of Chlorine (Cl) and Bromine (Br) based flame retardants meet JS709B low halogen requirements of  $\leq 1000$ ppm threshold. Antimony trioxide based flame retardants must also meet the  $\leq 1000$ ppm threshold requirement.

(3) MSL, Peak Temp. - The Moisture Sensitivity Level rating according to the JEDEC industry standard classifications, and peak solder temperature.

(4) There may be additional marking, which relates to the logo, the lot trace code information, or the environmental category on the device.

(5) Multiple Device Markings will be inside parentheses. Only one Device Marking contained in parentheses and separated by a "~" will appear on a device. If a line is indented then it is a continuation of the previous line and the two combined represent the entire Device Marking for that device.

(6) Lead/Ball Finish - Orderable Devices may have multiple material finish options. Finish options are separated by a vertical ruled line. Lead/Ball Finish values may wrap to two lines if the finish value exceeds the maximum column width.

**Important Information and Disclaimer:** The information provided on this page represents TI's knowledge and belief as of the date that it is provided. TI bases its knowledge and belief on information provided by third parties, and makes no representation or warranty as to the accuracy of such information. Efforts are underway to better integrate information from third parties. TI has taken and continues to take reasonable steps to provide representative and accurate information but may not have conducted destructive testing or chemical analysis on incoming materials and chemicals. TI and TI suppliers consider certain information to be proprietary, and thus CAS numbers and other limited information may not be available for release.

In no event shall TI's liability arising out of such information exceed the total purchase price of the TI part(s) at issue in this document sold by TI to Customer on an annual basis.

**TAPE AND REEL INFORMATION**

**QUADRANT ASSIGNMENTS FOR PIN 1 ORIENTATION IN TAPE**

\*All dimensions are nominal

Device	Package Type	Package Drawing	Pins	SPQ	Reel Diameter (mm)	Reel Width W1 (mm)	A0 (mm)	B0 (mm)	K0 (mm)	P1 (mm)	W (mm)	Pin1 Quadrant
TPS62800YKAR	DSBGA	YKA	6	3000	178.0	8.4	0.81	1.16	0.46	4.0	8.0	Q1
TPS62800YKAT	DSBGA	YKA	6	250	178.0	8.4	0.81	1.16	0.46	4.0	8.0	Q1
TPS62801YKAR	DSBGA	YKA	6	3000	178.0	8.4	0.81	1.16	0.46	4.0	8.0	Q1
TPS62801YKAT	DSBGA	YKA	6	250	178.0	8.4	0.81	1.16	0.46	4.0	8.0	Q1
TPS62802YKAR	DSBGA	YKA	6	3000	178.0	8.4	0.81	1.16	0.46	4.0	8.0	Q1
TPS62806YKAR	DSBGA	YKA	6	3000	178.0	8.4	0.81	1.16	0.46	4.0	8.0	Q1
TPS62806YKAT	DSBGA	YKA	6	250	178.0	8.4	0.81	1.16	0.46	4.0	8.0	Q1
TPS62807YKAR	DSBGA	YKA	6	3000	178.0	8.4	0.81	1.16	0.46	4.0	8.0	Q1
TPS62807YKAT	DSBGA	YKA	6	250	178.0	8.4	0.81	1.16	0.46	4.0	8.0	Q1
TPS62808YKAR	DSBGA	YKA	6	3000	178.0	8.4	0.81	1.16	0.46	4.0	8.0	Q1
TPS62808YKAT	DSBGA	YKA	6	250	178.0	8.4	0.81	1.16	0.46	4.0	8.0	Q1



**TAPE AND REEL BOX DIMENSIONS**

\*All dimensions are nominal

Device	Package Type	Package Drawing	Pins	SPQ	Length (mm)	Width (mm)	Height (mm)
TPS62800YKAR	DSBGA	YKA	6	3000	220.0	220.0	35.0
TPS62800YKAT	DSBGA	YKA	6	250	220.0	220.0	35.0
TPS62801YKAR	DSBGA	YKA	6	3000	220.0	220.0	35.0
TPS62801YKAT	DSBGA	YKA	6	250	220.0	220.0	35.0
TPS62802YKAR	DSBGA	YKA	6	3000	220.0	220.0	35.0
TPS62806YKAR	DSBGA	YKA	6	3000	220.0	220.0	35.0
TPS62806YKAT	DSBGA	YKA	6	250	220.0	220.0	35.0
TPS62807YKAR	DSBGA	YKA	6	3000	220.0	220.0	35.0
TPS62807YKAT	DSBGA	YKA	6	250	220.0	220.0	35.0
TPS62808YKAR	DSBGA	YKA	6	3000	220.0	220.0	35.0
TPS62808YKAT	DSBGA	YKA	6	250	220.0	220.0	35.0

YKA0006

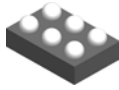

PACKAGE OUTLINE

DSBGA - 0.4 mm max height

DIE SIZE BALL GRID ARRAY

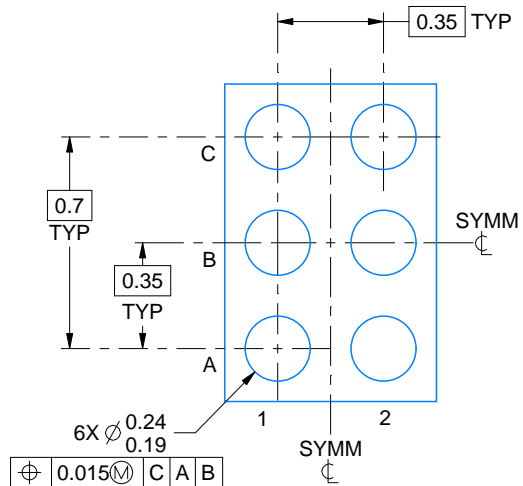
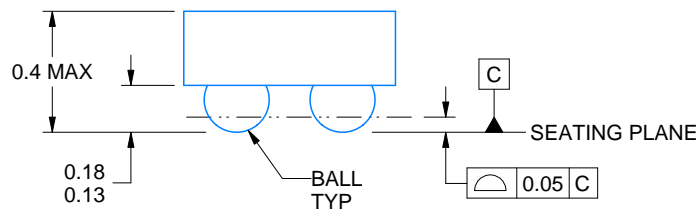
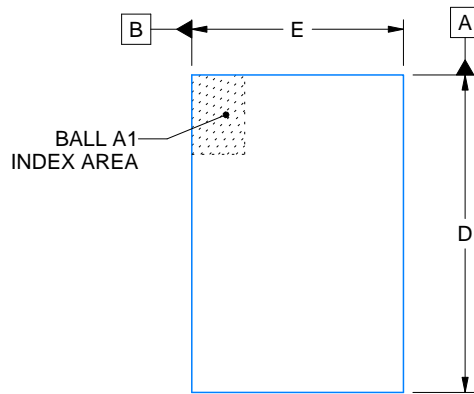

D: Max = 1.084 mm, Min = 1.024 mm  
 E: Max = 0.734 mm, Min = 0.674 mm

4223607/A 03/2017

NOTES:

NanoFree is a trademark of Texas Instruments.

1. All linear dimensions are in millimeters. Any dimensions in parenthesis are for reference only. Dimensioning and tolerancing per ASME Y14.5M.
2. This drawing is subject to change without notice.
3. NanoFree™ package configuration.

# EXAMPLE BOARD LAYOUT

YKA0006

DSBGA - 0.4 mm max height

DIE SIZE BALL GRID ARRAY

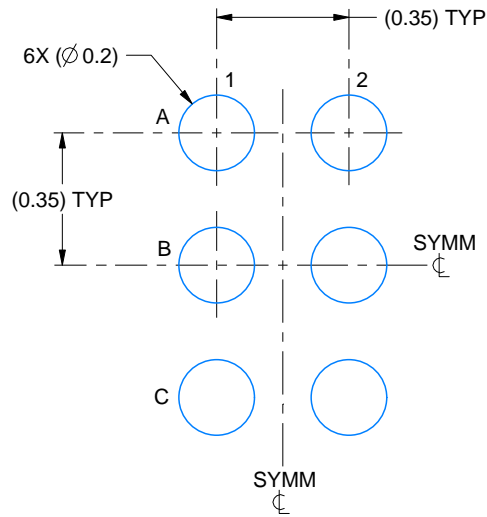

LAND PATTERN EXAMPLE  
EXPOSED METAL SHOWN  
SCALE:50X

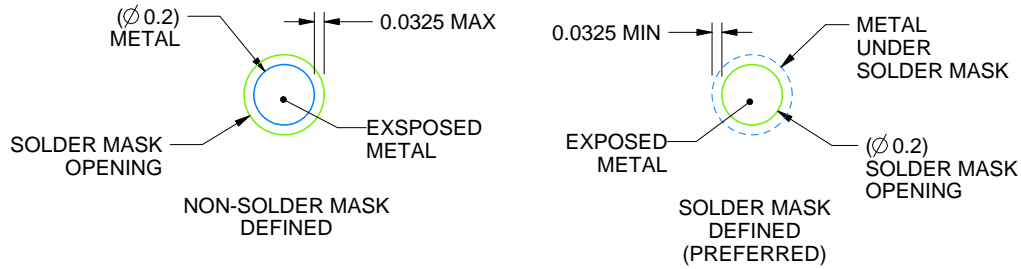

SOLDER MASK DETAILS  
NOT TO SCALE

4223607/A 03/2017

NOTES: (continued)

- Final dimensions may vary due to manufacturing tolerance considerations and also routing constraints. For more information, see Texas Instruments literature number SNVA009 ([www.ti.com/lit/snva009](http://www.ti.com/lit/snva009)).



## IMPORTANT NOTICE AND DISCLAIMER

TI PROVIDES TECHNICAL AND RELIABILITY DATA (INCLUDING DATASHEETS), DESIGN RESOURCES (INCLUDING REFERENCE DESIGNS), APPLICATION OR OTHER DESIGN ADVICE, WEB TOOLS, SAFETY INFORMATION, AND OTHER RESOURCES "AS IS" AND WITH ALL FAULTS, AND DISCLAIMS ALL WARRANTIES, EXPRESS AND IMPLIED, INCLUDING WITHOUT LIMITATION ANY IMPLIED WARRANTIES OF MERCHANTABILITY, FITNESS FOR A PARTICULAR PURPOSE OR NON-INFRINGEMENT OF THIRD PARTY INTELLECTUAL PROPERTY RIGHTS.

These resources are intended for skilled developers designing with TI products. You are solely responsible for (1) selecting the appropriate TI products for your application, (2) designing, validating and testing your application, and (3) ensuring your application meets applicable standards, and any other safety, security, or other requirements. These resources are subject to change without notice. TI grants you permission to use these resources only for development of an application that uses the TI products described in the resource. Other reproduction and display of these resources is prohibited. No license is granted to any other TI intellectual property right or to any third party intellectual property right. TI disclaims responsibility for, and you will fully indemnify TI and its representatives against, any claims, damages, costs, losses, and liabilities arising out of your use of these resources.

TI's products are provided subject to TI's Terms of Sale ([www.ti.com/legal/termsofsale.html](http://www.ti.com/legal/termsofsale.html)) or other applicable terms available either on [ti.com](http://ti.com) or provided in conjunction with such TI products. TI's provision of these resources does not expand or otherwise alter TI's applicable warranties or warranty disclaimers for TI products.

Mailing Address: Texas Instruments, Post Office Box 655303, Dallas, Texas 75265  
Copyright © 2019, Texas Instruments Incorporated