

# TPS22916xx 1-V–5.5-V, 2-A, 60-mΩ Ultra-Low Leakage Load Switch

## 1 Features

- Input operating voltage range ( $V_{IN}$ ): 1 V–5.5 V
- Maximum continuous current ( $I_{MAX}$ ): 2 A
- ON-resistance ( $R_{ON}$ ):
  - 5  $V_{IN}$  = 60 mΩ (typ.), 100 mΩ (85°C max.)
  - 1.8  $V_{IN}$  = 100 mΩ (typ.), 150 mΩ (85°C max.)
  - 1  $V_{IN}$  = 200 mΩ (typ.), 325 mΩ (85°C max.)
- Ultra-low power consumption:
  - ON state ( $I_Q$ ): 0.5 μA (typ.), 1 μA (max.)
  - OFF state ( $I_{SD}$ ): 10 nA (typ.), 100 nA (max.)
  - TPS22916BL/CL/CNL ( $I_{SD}$ ): 100 nA (typ.), 300 nA (max.)
- Smart ON pin pulldown ( $R_{PD}$ ):
  - ON  $\geq V_{IH}$  ( $I_{ON}$ ): 10 nA (max.)
  - ON  $\leq V_{IL}$  ( $R_{PD}$ ): 750 kΩ (typ.)
- Slow Timing in C Version Limits Inrush Current:
  - 5-V turn-on time ( $t_{ON}$ ): 1400 μs at 5 mV/μs
  - 1.8-V turn-on time ( $t_{ON}$ ): 3000 μs at 1 mV/μs
  - 1-V turn-on time ( $t_{ON}$ ): 6500 μs at 0.3 mV/μs
- Fast timing in b version reduces wait time:
  - 5-V turn-on time ( $t_{ON}$ ): 115 μs at 57 mV/μs
  - 1.8-V turn-on time ( $t_{ON}$ ): 250 μs at 12 mV/μs
  - 1-V turn-on time ( $t_{ON}$ ): 510 μs at 3.3 mV/μs
- Always-ON true Reverse Current Blocking (RCB):
  - Activation current ( $I_{RCB}$ ): –500 mA (typ.)
  - Reverse leakage ( $I_{IN,RCB}$ ): –300 nA (max.)
- Quick Output Discharge (QOD): 150 Ω (typ.) (N version has no QOD)
- Active low enable option (L versions)

## 2 Applications

- Wearables
- Smartphones
- Tablets
- Portable speakers

## 3 Description

The TPS22916xx is a small, single channel load switch using a low leakage P-Channel MOSFET for minimum power loss. Advanced gate control design supports operating voltages as low as 1 V with minimal increase in ON-resistance and power loss.

Multiple timing options are available to support various system loading conditions. For heavy capacitive loads, the slow turn-on timing in the C version minimizes the inrush current. In cases with light capacitive loads, the fast timing in the B version reduces required wait time.

The switch ON state is controlled by a digital input that is capable of interfacing directly with low-voltage control signals. Both Active High and Active Low (L) versions are available. When power is first applied, a smart pulldown is used to keep the ON pin from floating until system sequencing is complete. After the ON pin is deliberately driven high ( $\geq V_{IH}$ ), the smart pulldown is disconnected to prevent unnecessary power loss.

The TPS22916xx is available in a small, space saving 0.78 mm × 0.78 mm, 0.4-mm pitch, 0.5-mm height 4-pin Wafer-Chip-Scale (WCSP) package (YFP). The device is characterized for operation over a temperature range of –40°C to +85°C.

### Device Information<sup>(1)</sup>

PART NUMBER	PACKAGE	BODY SIZE (NOM)
TPS22916xx	WCSP (4)	0.78 mm × 0.78 mm

- (1) For all available packages, see the orderable addendum at the end of the data sheet.

### Device Comparison Table

VERSION	TIMING	QOD	ENABLE (ON)
TPS22916B	Fast	Yes	Active High
TPS22916BL	Fast	Yes	Active Low
TPS22916C	Slow	Yes	Active High
TPS22916CN	Slow	No	Active High
TPS22916CL	Slow	Yes	Active Low
TPS22916CNL	Slow	No	Active Low

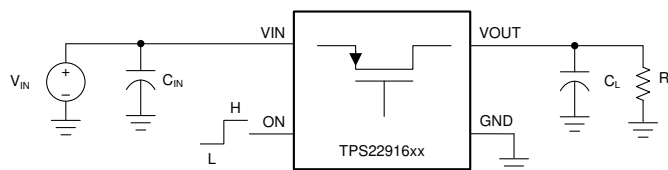

Copyright © 2017, Texas Instruments Incorporated

### Simplified Schematic



An IMPORTANT NOTICE at the end of this data sheet addresses availability, warranty, changes, use in safety-critical applications, intellectual property matters and other important disclaimers. PRODUCTION DATA.

## Table of Contents

<b>1 Features</b> .....	<b>1</b>	<b>9 Application and Implementation</b> .....	<b>18</b>
<b>2 Applications</b> .....	<b>1</b>	9.1 Application Information.....	18
<b>3 Description</b> .....	<b>1</b>	9.2 Typical Application.....	18
<b>4 Revision History</b> .....	<b>2</b>	<b>10 Power Supply Recommendations</b> .....	<b>19</b>
<b>5 Pin Configuration and Functions</b> .....	<b>3</b>	<b>11 Layout</b> .....	<b>20</b>
<b>6 Specifications</b> .....	<b>4</b>	11.1 Layout Guidelines.....	20
6.1 Absolute Maximum Ratings.....	4	11.2 Layout Example.....	20
6.2 ESD Ratings.....	4	11.3 Thermal Considerations.....	20
6.3 Recommended Operating Conditions.....	4	<b>12 Device and Documentation Support</b> .....	<b>21</b>
6.4 Thermal Information.....	4	12.1 Documentation Support.....	21
6.5 Electrical Characteristics.....	5	12.2 Receiving Notification of Documentation Updates.....	21
6.6 Switching Characteristics.....	6	12.3 Support Resources.....	21
6.7 Typical Characteristics.....	8	12.4 Trademarks.....	21
<b>7 Parameter Measurement Information</b> .....	<b>15</b>	12.5 Electrostatic Discharge Caution.....	21
<b>8 Detailed Description</b> .....	<b>16</b>	12.6 Glossary.....	21
8.1 Overview.....	16	<b>13 Mechanical, Packaging, and Orderable Information</b> .....	<b>21</b>
8.2 Functional Block Diagram.....	16	13.1 Tape and Reel Information.....	22
8.3 Feature Description.....	16		
8.4 Device Functional Modes.....	17		

## 4 Revision History

NOTE: Page numbers for previous revisions may differ from page numbers in the current version.

<b>Changes from Revision E (September 2020) to Revision F (December 2021)</b> .....	<b>Page</b>
• Added TPS22916CNL and TPS22916BL orderables to the data sheet.....	1
<b>Changes from Revision D (October 2019) to Revision E (September 2020)</b> .....	<b>Page</b>
• Updated the numbering format for tables, figures and cross-references throughout the document.....	1
<b>Changes from Revision C (October 2018) to Revision D (October 2019)</b> .....	<b>Page</b>
• Changed package dimensions from 0.74 mm x 0.74 mm to 0.78 mm x 0.78 mm.....	1
<b>Changes from Revision B (December 2017) to Revision C (October 2018)</b> .....	<b>Page</b>
• Changed Package Drawing Dimensions .....	21
<b>Changes from Revision A (September 2017) to Revision B (December 2017)</b> .....	<b>Page</b>
• Changed Pinout drawing labeled Laser Marking.....	1
<b>Changes from Revision * (July 2017) to Revision A (September 2017)</b> .....	<b>Page</b>
• Changed device document from Advanced Info to Production Data .....	1

## 5 Pin Configuration and Functions

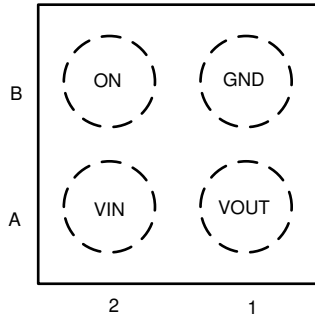

Figure 5-1. YFP Package 4-Pin WSON Laser Marking View

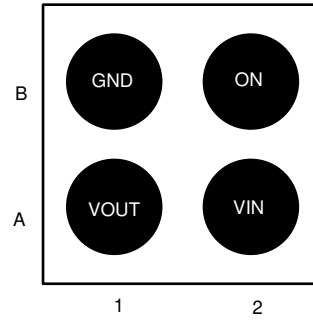

Figure 5-2. YFP Package 4-Pin WSON Bump View

Table 5-1. Pin Functions

PIN		TYPE	DESCRIPTION
NO.	NAME		
A1	VOUT	Power	Switch output
A2	VIN	Power	Switch input
B1	GND	Ground	Device ground
B2	ON	Digital input	Device enable

## 6 Specifications

### 6.1 Absolute Maximum Ratings

Over operating free-air temperature range (unless otherwise noted)<sup>(1)</sup>

		MIN	MAX	UNIT
V <sub>IN</sub>	Input voltage	-0.3	6	V
V <sub>OUT</sub>	Output voltage	-0.3	6	V
V <sub>ON</sub>	Enable voltage	-0.3	6	V
I <sub>MAX</sub>	Maximum continuous switch current		2	A
I <sub>PLS</sub>	Maximum pulsed switch current, pulse < 300- $\mu$ s, 2% duty cycle		2.5	A
T <sub>J,MAX</sub>	Maximum junction temperature		125	°C
T <sub>STG</sub>	Storage temperature	-65	150	°C
T <sub>LEAD</sub>	Maximum Lead temperature (10-s soldering time)		300	°C

- (1) Stresses beyond those listed under *Absolute Maximum Ratings* may cause permanent damage to the device. These are stress ratings only, which do not imply functional operation of the device at these or any other conditions beyond those indicated under *Recommended Operating Conditions*. Exposure to absolute-maximum-rated conditions for extended periods may affect device reliability.

### 6.2 ESD Ratings

		VALUE	UNIT
V <sub>(ESD)</sub>	Electrostatic discharge	Human-body model (HBM), per ANSI/ESDA/JEDEC JS-001 <sup>(1)</sup>	V
		Charged-device model (CDM), per JEDEC specification JESD22-C101 <sup>(2)</sup>	

- (1) JEDEC document JEP155 states that 500-V HBM allows safe manufacturing with a standard ESD control process. Manufacturing with less than 500-V HBM is possible with the necessary precautions. Pins listed as  $\pm 2000$  V may actually have higher performance.
- (2) JEDEC document JEP157 states that 250-V CDM allows safe manufacturing with a standard ESD control process. Manufacturing with less than 250-V CDM is possible with the necessary precautions. Pins listed as  $\pm 500$  V may actually have higher performance.

### 6.3 Recommended Operating Conditions

Over operating free-air temperature range (unless otherwise noted)

		MIN	MAX	UNIT
V <sub>IN</sub>	Input voltage	1	5.5	V
V <sub>OUT</sub>	Output voltage	0	5.5	V
V <sub>IH</sub>	High-level input voltage, ON	1	5.5	V
V <sub>IL</sub>	Low-level input voltage, ON	0	0.35	V
T <sub>A</sub>	Operating free-air temperature	-40	85	°C

### 6.4 Thermal Information

Thermal Parameters <sup>(1)</sup>	TPS22916xx	UNIT	
	YFP (WCSP)		
	4 PINS		
$\theta_{JA}$	Junction-to-ambient thermal resistance	193	°C/W
$\theta_{JCTop}$	Junction-to-case (top) thermal resistance	2.3	°C/W
$\theta_{JB}$	Junction-to-board thermal resistance	36	°C/W
$\psi_{JT}$	Junction-to-top characterization parameter	12	°C/W
$\psi_{JB}$	Junction-to-board characterization parameter	36	°C/W

- (1) For more information about traditional and new thermal metrics, see the [Semiconductor and IC Package Thermal Metrics](#) application report.

## 6.5 Electrical Characteristics

Unless otherwise noted, the specification in the following table applies for all variants over the entire recommended power supply voltage range of 1 V to 5.5 V unless noted otherwise. Typical Values are at 25°C.

PARAMETER		TEST CONDITIONS	T <sub>J</sub>	MIN	TYP	MAX	UNIT
<b>INPUT SUPPLY (VIN)</b>							
I <sub>Q,VIN</sub>	V <sub>IN</sub> Quiescent current	Enabled, V <sub>OUT</sub> = Open	-40°C to +85°C	0.5	1.0		μA
I <sub>SD,VIN</sub>	V <sub>IN</sub> Shutdown current	Disabled, V <sub>OUT</sub> = GND (TPS22916B/C/CN)	-40°C to +85°C	10	100		nA
		Disabled, V <sub>OUT</sub> = GND (TPS22916BL/CL/CNL)	-40°C to +85°C	100	300		nA
<b>ON-RESISTANCE (R<sub>ON</sub>)</b>							
R <sub>ON</sub>	ON-Resistance	I <sub>OUT</sub> = 200 mA	V <sub>IN</sub> = 5 V	25°C	60	80	mΩ
				-40°C to +85°C		100	
				-40°C to +105°C		120	
			V <sub>IN</sub> = 3.6 V	25°C	70	90	
				-40°C to +85°C		120	
				-40°C to +105°C		140	
			V <sub>IN</sub> = 1.8 V	25°C	100	125	
				-40°C to +85°C		150	
				-40°C to +105°C		175	
			V <sub>IN</sub> = 1.2 V	25°C	150	200	
				-40°C to +85°C		250	
				-40°C to +105°C		300	
			V <sub>IN</sub> = 1 V	25°C	200	275	
				-40°C to +85°C		325	
				-40°C to +105°C		375	
<b>ENABLE PIN (ON)</b>							
I <sub>ON</sub>	ON Pin leakage	Enabled	-40°C to +85°C	-10		10	nA
R <sub>PD</sub>	Smart Pull Down Resistance	Disabled	-40°C to +85°C	750			kΩ
<b>REVERSE CURRENT BLOCKING (RCB)</b>							
I <sub>RCB</sub>	RCB Activation Current	Enabled, V <sub>OUT</sub> > V <sub>IN</sub>	-40°C to +85°C	-500			mA
t <sub>RCB</sub>	RCB Activation time	Enabled, V <sub>OUT</sub> > V <sub>IN</sub> + 200mV	-40°C to +85°C	10			μs
V <sub>RCB</sub>	RCB Release Voltage	Enabled, V <sub>OUT</sub> > V <sub>IN</sub>	-40°C to +85°C	25			mV
I <sub>IN,RCB</sub>	V <sub>IN</sub> Reverse Leakage Current	0 V ≤ V <sub>IN</sub> + V <sub>RCB</sub> ≤ V <sub>OUT</sub> ≤ 5.5 V	-40°C to +85°C	-300			nA
<b>QUICK OUTPUT DISCHARGE (QOD)</b>							
QOD <sup>(1)</sup>	Output discharge resistance	Disabled (Not in TPS22916CN/CNL)	-40°C to +85°C	150			Ω

(1) For more information on which devices include quick output discharge, see the [Device Functional Modes](#) section.

## 6.6 Switching Characteristics

Unless otherwise noted, the typical characteristics in the following table applies over the entire recommended power supply voltage range of 1 V to 5.5 V at 25°C with a load of  $C_L = 0.1\mu\text{F}$ ,  $R_L = 10\Omega$ .

PARAMETER		TEST CONDITIONS	MIN	TYP	MAX	UNIT
<b>TPS22916B, TPS22916BL</b>						
$t_{\text{ON}}$	Turn On Time	$V_{\text{IN}} = 5\text{ V}$		115		$\mu\text{s}$
		$V_{\text{IN}} = 3.6\text{ V}$		140		
		$V_{\text{IN}} = 1.8\text{ V}$		250		
		$V_{\text{IN}} = 1.2\text{ V}$		350		
		$V_{\text{IN}} = 1\text{ V}$		510		
$t_{\text{RISE}}$	Rise Time	$V_{\text{IN}} = 5\text{ V}$		70		$\mu\text{s}$
		$V_{\text{IN}} = 3.6\text{ V}$		80		
		$V_{\text{IN}} = 1.8\text{ V}$		130		
		$V_{\text{IN}} = 1.2\text{ V}$		190		
		$V_{\text{IN}} = 1\text{ V}$		240		
$SR_{\text{ON}}$	Slew Rate	$V_{\text{IN}} = 5\text{ V}$		57		$\text{mV}/\mu\text{s}$
		$V_{\text{IN}} = 3.6\text{ V}$		36		
		$V_{\text{IN}} = 1.8\text{ V}$		12		
		$V_{\text{IN}} = 1.2\text{ V}$		5.1		
		$V_{\text{IN}} = 1\text{ V}$		3.3		
$t_{\text{OFF}}$	Turn Off Time	$V_{\text{IN}} = 5\text{ V}$		5		$\mu\text{s}$
		$V_{\text{IN}} = 3.6\text{ V}$		5		
		$V_{\text{IN}} = 1.8\text{ V}$		10		
		$V_{\text{IN}} = 1.2\text{ V}$		15		
		$V_{\text{IN}} = 1\text{ V}$		25		
$t_{\text{FALL}}$	Fall Time	$C_L = 0.1\mu\text{F}$ , $R_L = 10\Omega$ <sup>(1)</sup>		2.3		$\mu\text{s}$
		$C_L = 1\mu\text{F}$ , $R_L = \text{Open}$ <sup>(1)</sup>		315		

## 6.6 Switching Characteristics (continued)

Unless otherwise noted, the typical characteristics in the following table applies over the entire recommended power supply voltage range of 1 V to 5.5 V at 25°C with a load of  $C_L = 0.1\mu\text{F}$ ,  $R_L = 10\Omega$ .

PARAMETER	TEST CONDITIONS	MIN	TYP	MAX	UNIT
<b>TPS22916C, TPS22916CN, TPS22916CL, TPS22916CNL</b>					
$t_{\text{ON}}$	Turn On Time	$V_{\text{IN}} = 5\text{ V}$		1400	$\mu\text{s}$
		$V_{\text{IN}} = 3.6\text{ V}$		1700	
		$V_{\text{IN}} = 1.8\text{ V}$		3000	
		$V_{\text{IN}} = 1.2\text{ V}$		5000	
		$V_{\text{IN}} = 1\text{ V}$		6500	
$t_{\text{RISE}}$	Rise Time	$V_{\text{IN}} = 5\text{ V}$		800	$\mu\text{s}$
		$V_{\text{IN}} = 3.6\text{ V}$		900	
		$V_{\text{IN}} = 1.8\text{ V}$		1400	
		$V_{\text{IN}} = 1.2\text{ V}$		2300	
		$V_{\text{IN}} = 1\text{ V}$		3000	
$SR_{\text{ON}}$	Slew Rate	$V_{\text{IN}} = 5\text{ V}$		5	$\text{mV}/\mu\text{s}$
		$V_{\text{IN}} = 3.6\text{ V}$		3.2	
		$V_{\text{IN}} = 1.8\text{ V}$		1	
		$V_{\text{IN}} = 1.2\text{ V}$		0.4	
		$V_{\text{IN}} = 1\text{ V}$		0.3	
$t_{\text{OFF}}$	Turn Off Time	$V_{\text{IN}} = 5\text{ V}$		5	$\mu\text{s}$
		$V_{\text{IN}} = 3.6\text{ V}$		5	
		$V_{\text{IN}} = 1.8\text{ V}$		10	
		$V_{\text{IN}} = 1.2\text{ V}$		15	
		$V_{\text{IN}} = 1\text{ V}$		25	
$t_{\text{FALL}}$	Fall Time <sup>(2)</sup>	$C_L = 0.1\mu\text{F}$ , $R_L = 10\Omega$ <sup>(1)</sup>		2.3	$\mu\text{s}$
		$C_L = 10\mu\text{F}$ , $R_L = \text{Open}$ <sup>(1)</sup>		3150	

- (1) See the [Fall Time \( \$t\_{\text{FALL}}\$ \) and Quick Output Discharge \(QOD\)](#) section for information on how  $R_L$  and  $C_L$  affect Fall Time.  
(2) Devices without Quick Output Discharge (QOD) may not discharge completely.

## 6.7 Typical Characteristics

### 6.7.1 Typical Electrical Characteristics

The typical characteristics curves in this section apply to all devices unless otherwise noted.

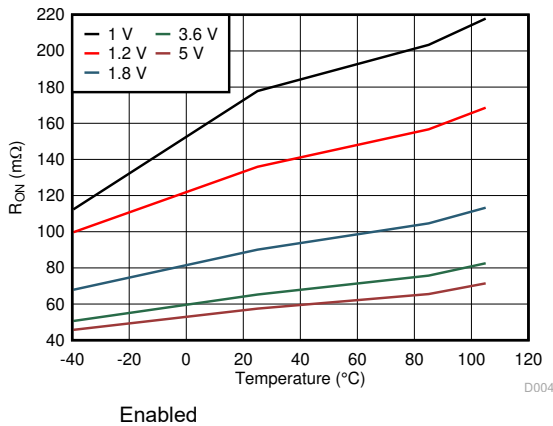

Enabled  
**Figure 6-1. ON-Resistance vs Temperature**

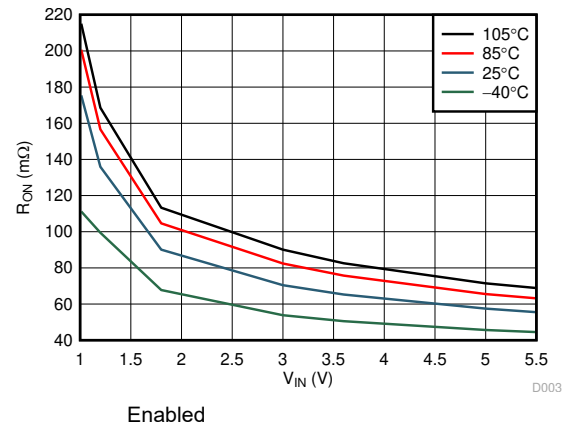

Enabled  
**Figure 6-2. ON-Resistance vs Input voltage**

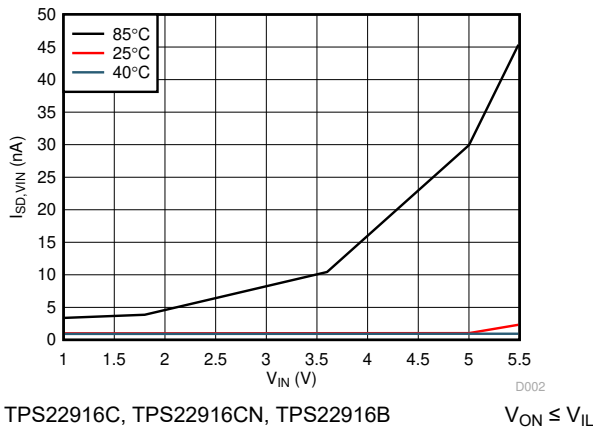

TPS22916C, TPS22916CN, TPS22916B  
**Figure 6-3. Shutdown Current**  
 $V_{ON} \leq V_{IL}$

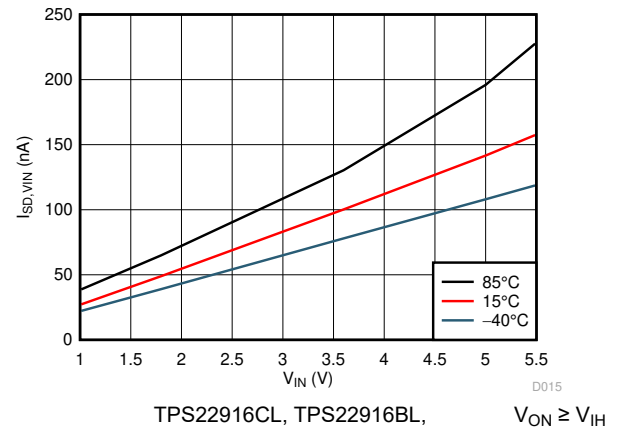

TPS22916CL, TPS22916BL, TPS22916CNL  
**Figure 6-4. Shutdown Current (Active Low)**  
 $V_{ON} \geq V_{IH}$

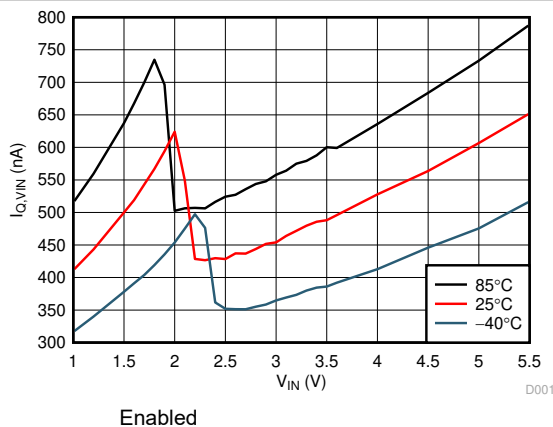

Enabled  
**Figure 6-5. Quiescent Current**

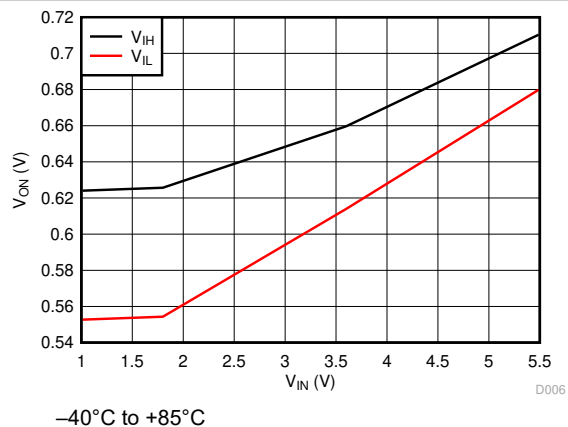

$-40^{\circ}\text{C}$  to  $+85^{\circ}\text{C}$   
**Figure 6-6. ON Pin Threshold**



### 6.7.1 Typical Electrical Characteristics (continued)

The typical characteristics curves in this section apply to all devices unless otherwise noted.

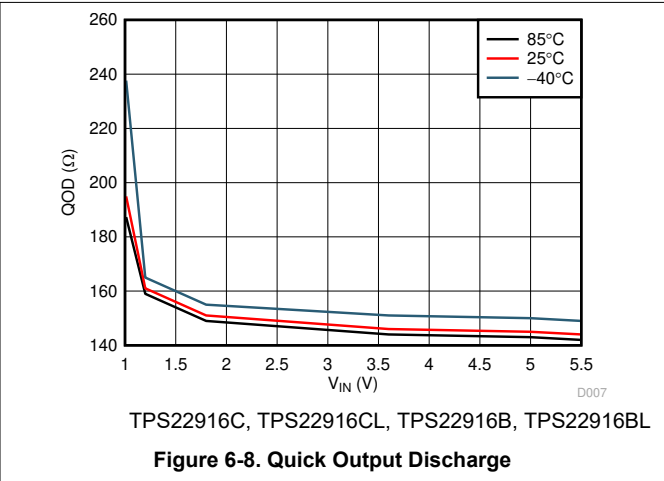
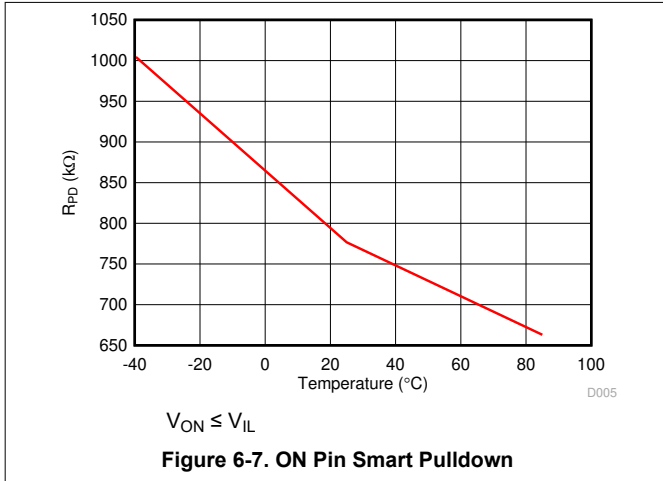

### 6.7.2 Typical Switching Characteristics

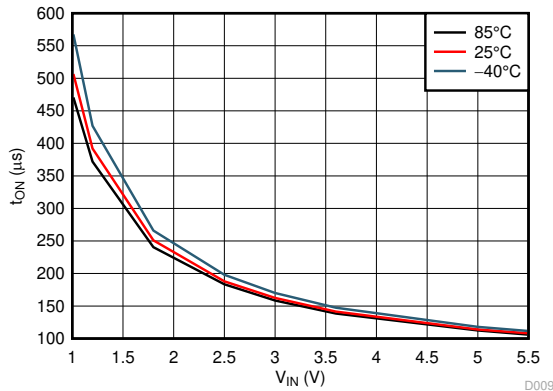

C<sub>L</sub> = 0.1 μF R<sub>L</sub> = 10 Ω

Figure 6-9. Fast Turn-On Time

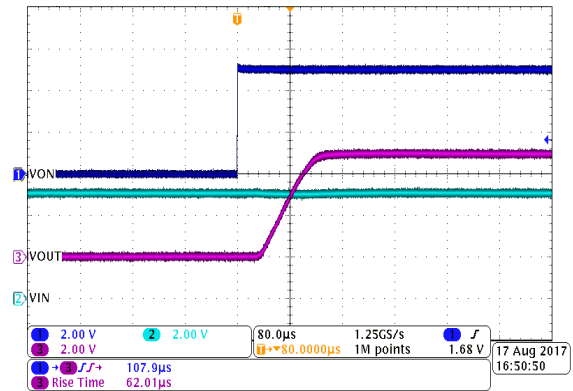

TPS22916B V<sub>IN</sub> = 5 V C<sub>L</sub> = 0.1 μF R<sub>L</sub> = 10 Ω

Figure 6-10. Fast Turn-On at 5 V

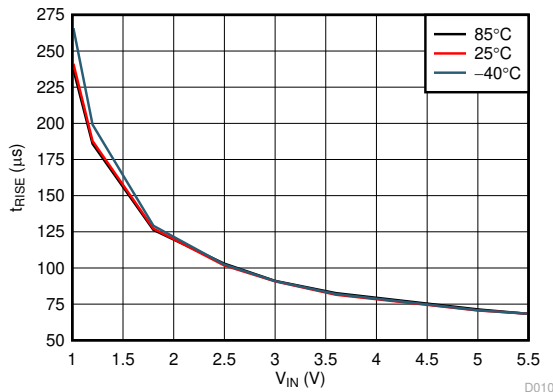

C<sub>L</sub> = 0.1 μF R<sub>L</sub> = 10 Ω

Figure 6-11. Fast Rise Time

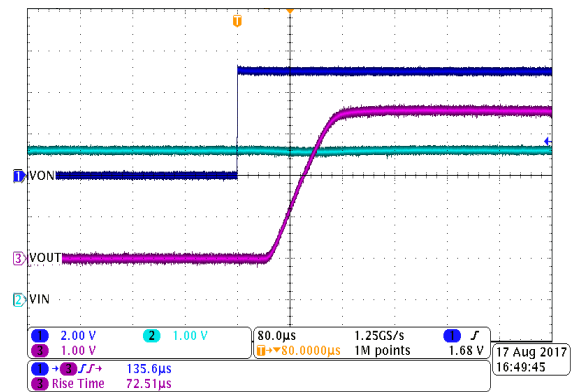

TPS22916B V<sub>IN</sub> = 3.6 V C<sub>L</sub> = 0.1 μF R<sub>L</sub> = 10 Ω

Figure 6-12. Fast Turn-On at 3.6 V

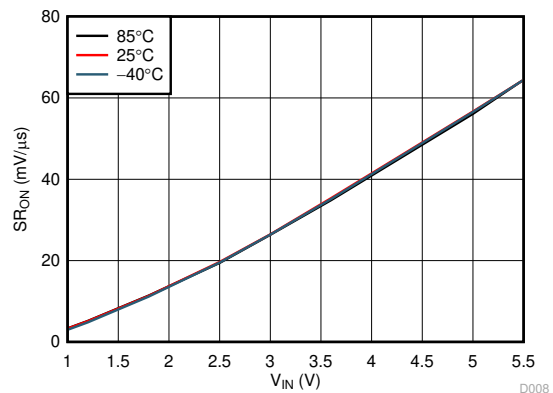

C<sub>L</sub> = 0.1 μF R<sub>L</sub> = 10 Ω

Figure 6-13. Fast Slew Rate

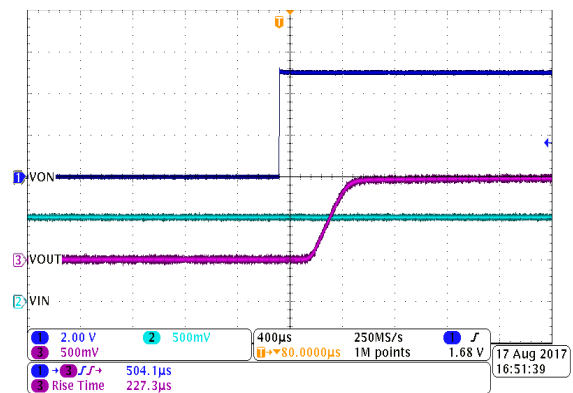

TPS22916B V<sub>IN</sub> = 1 V C<sub>L</sub> = 0.1 μF R<sub>L</sub> = 10 Ω

Figure 6-14. Fast Turn-On at 1 V

### 6.7.2 Typical Switching Characteristics (continued)

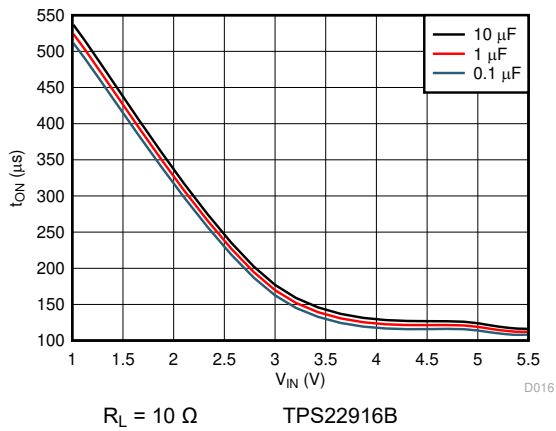

Figure 6-15. Fast Turn-On vs Load Capacitance

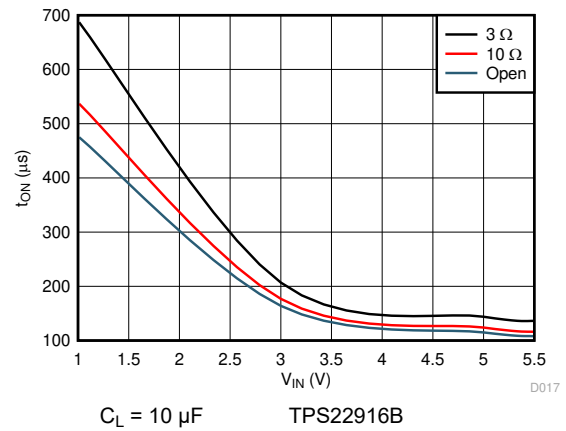

Figure 6-16. Fast Turn-On vs Load Resistance

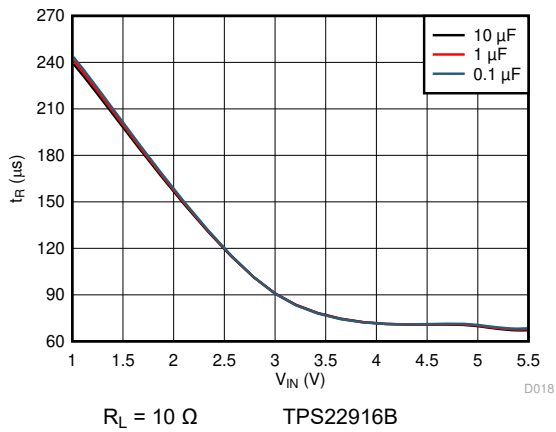

Figure 6-17. Fast Rise Time vs Load Capacitance

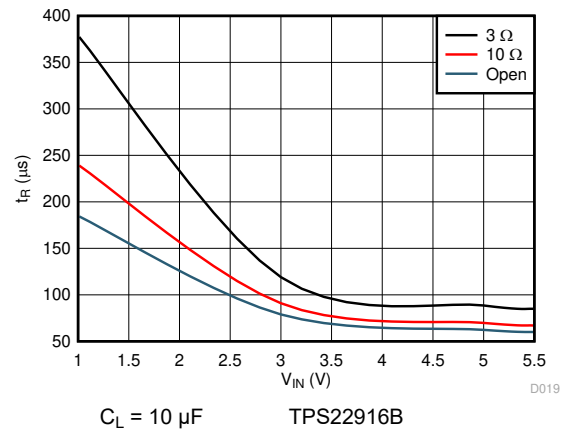

Figure 6-18. Fast Rise Time vs Load Resistance

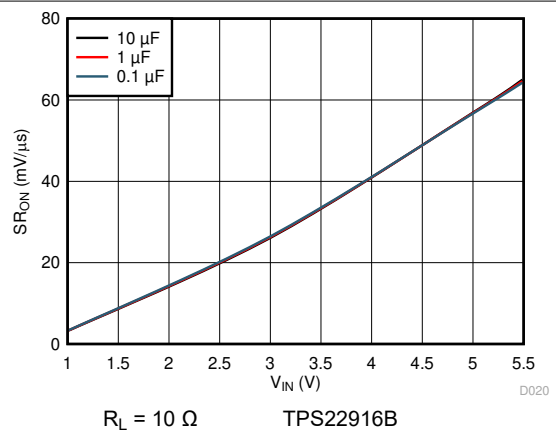

Figure 6-19. Fast Slew Rate vs Load Capacitance

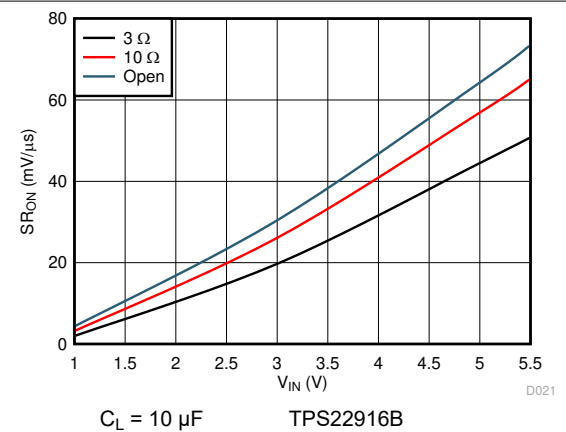
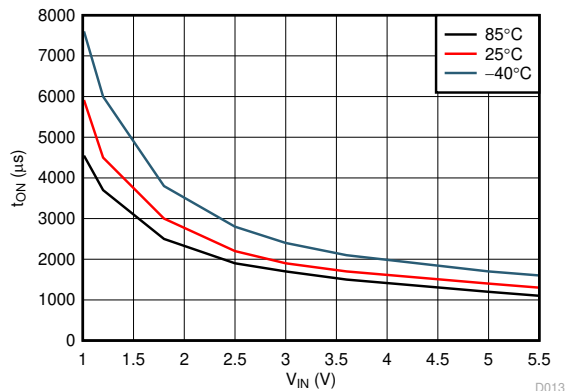

Figure 6-20. Fast Slew Rate vs Load Resistance

6.7.2 Typical Switching Characteristics (continued)



$C_L = 0.1 \mu F$   $R_L = 10 \Omega$

Figure 6-21. Slow Turn-On Time

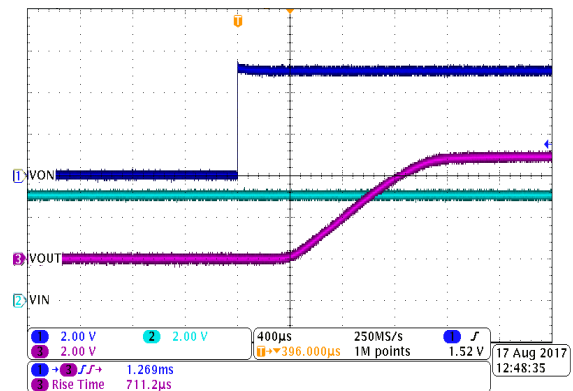

TPS22916C  $V_{IN} = 5V$   $C_L = 0.1 \mu F$   $R_L = 10 \Omega$

Figure 6-22. Slow Turn-On at 5 V

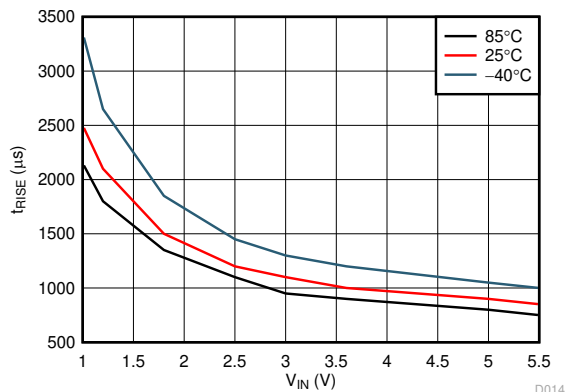

$C_L = 0.1 \mu F$   $R_L = 10 \Omega$

Figure 6-23. Slow Rise Time

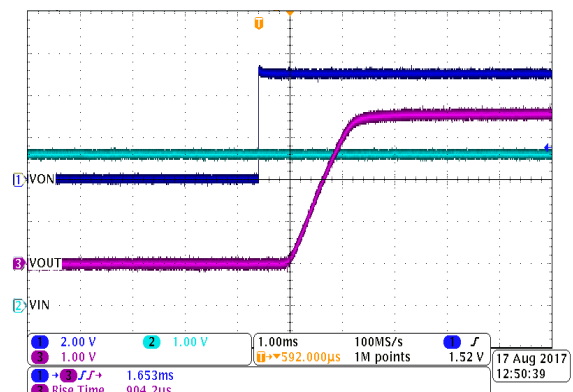

TPS22916C  $V_{IN} = 3.6V$   $C_L = 0.1 \mu F$   $R_L = 10 \Omega$

Figure 6-24. Slow Turn-On at 3.6 V

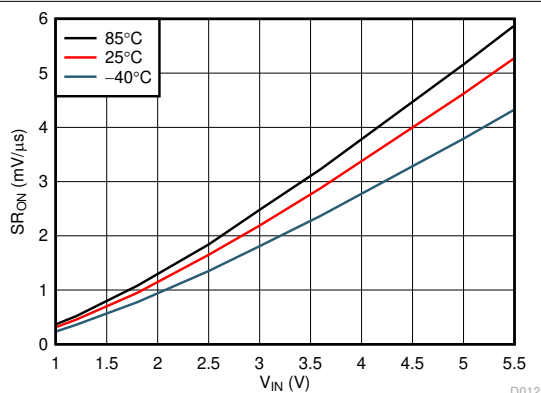

$C_L = 0.1 \mu F$   $R_L = 10 \Omega$

Figure 6-25. Slow Slew Rate

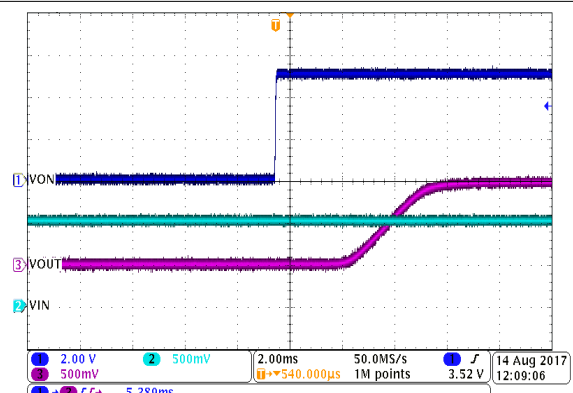

TPS22916C  $V_{IN} = 1V$   $C_L = 0.1 \mu F$   $R_L = 10 \Omega$

Figure 6-26. Slow Turn-On at 1 V

### 6.7.2 Typical Switching Characteristics (continued)

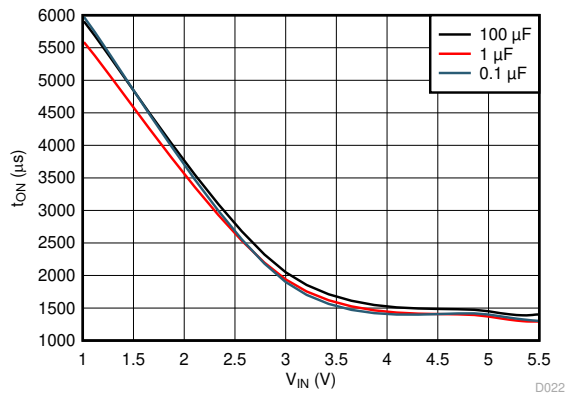

$R_L = 10 \Omega$  TPS22916C TPS22916CN TPS22916CL

**Figure 6-27. Slow Turn-On vs Load Capacitance**

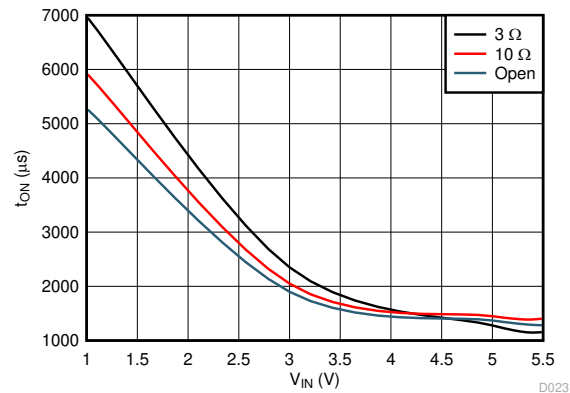

$C_L = 100 \mu\text{F}$  TPS22916C TPS22916CN TPS22916CL

**Figure 6-28. Slow Turn-On vs Load Resistance**

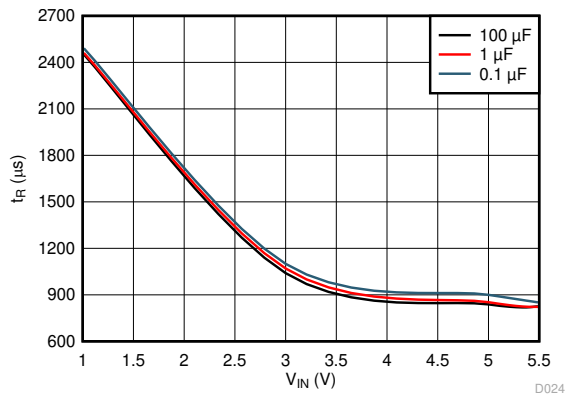

$R_L = 10 \Omega$  TPS22916C TPS22916CN TPS22916CL

**Figure 6-29. Slow Rise Time vs Load Capacitance**

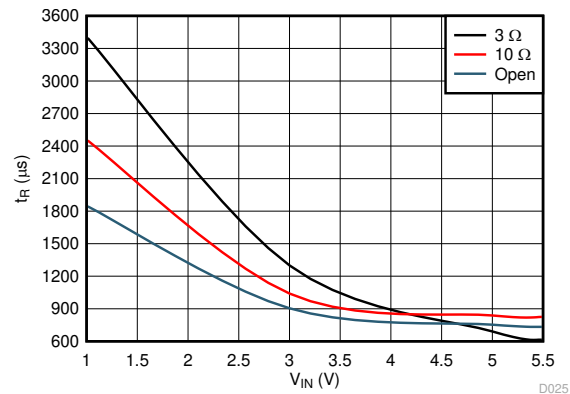

$C_L = 100 \mu\text{F}$  TPS22916C TPS22916CN TPS22916CL

**Figure 6-30. Slow Rise Time vs Load Resistance**

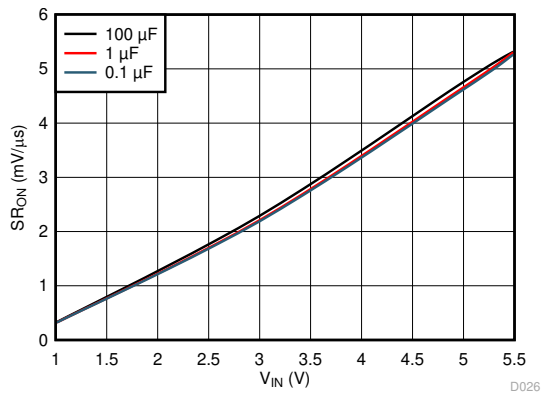

$R_L = 10 \Omega$  TPS22916C TPS22916CN TPS22916CL

**Figure 6-31. Slow Slew Rate vs Load Capacitance**

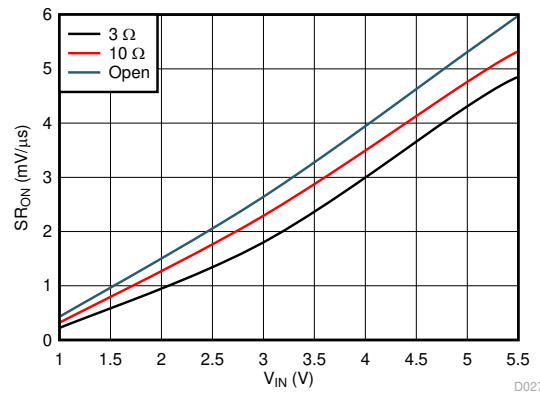

$C_L = 100 \mu\text{F}$  TPS22916C TPS22916CN TPS22916CL

**Figure 6-32. Slow Slew Rate vs Load Resistance**

6.7.2 Typical Switching Characteristics (continued)

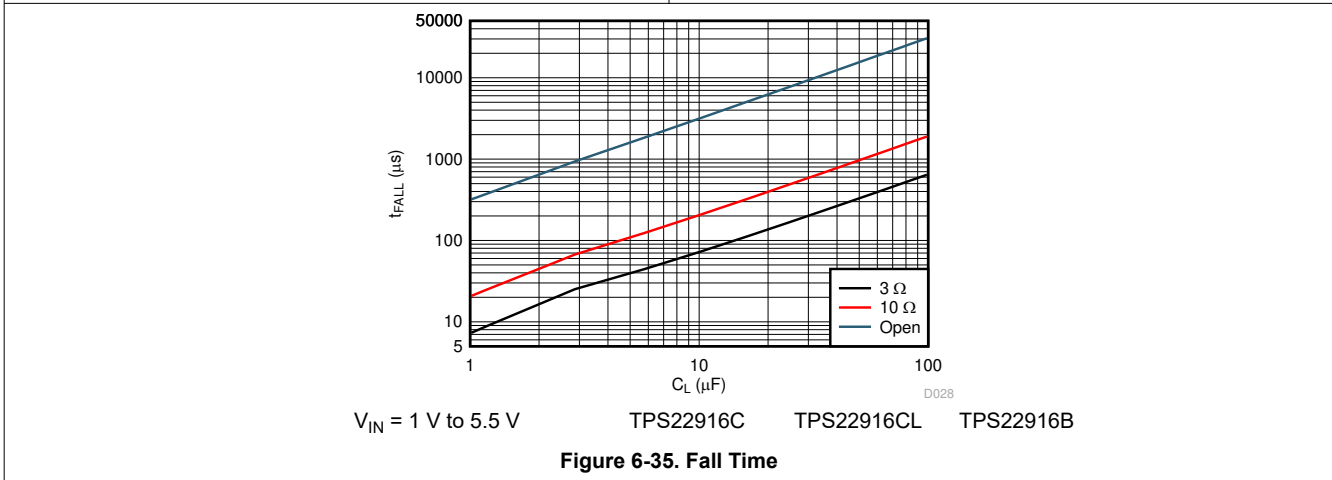
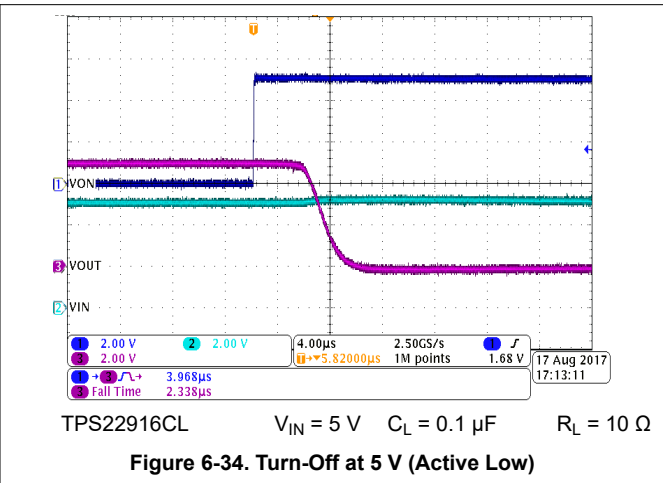
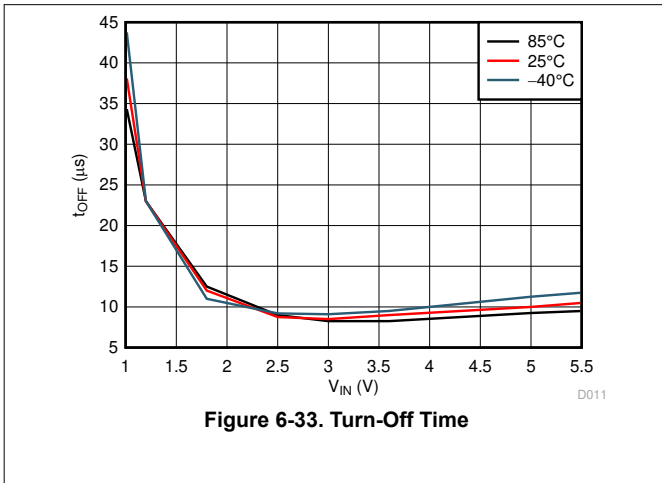

## 7 Parameter Measurement Information

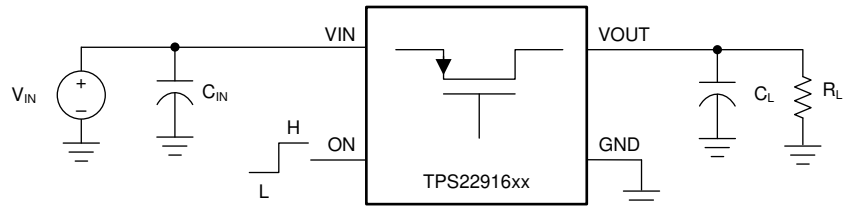

Copyright © 2017, Texas Instruments Incorporated

**Figure 7-1. TPS22916 Test Circuit**

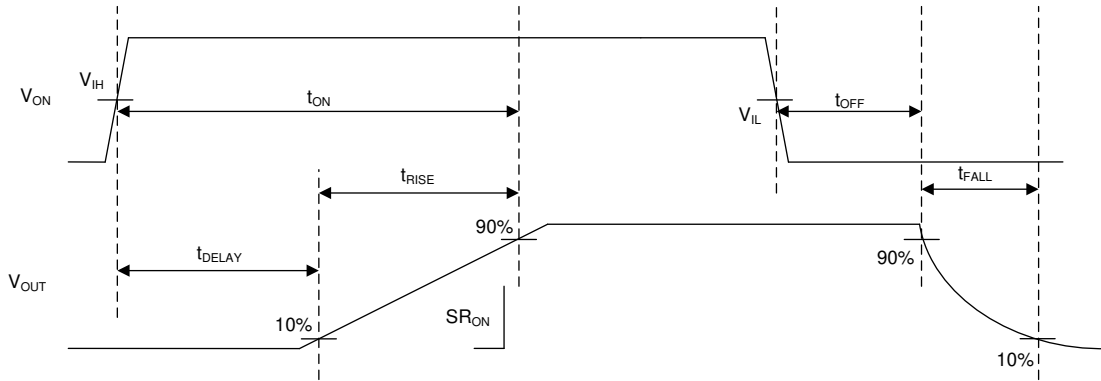

**Figure 7-2. TPS22916 Timing Waveform**

## 8 Detailed Description

### 8.1 Overview

This family of devices are single channel, 2-A load switches in ultra-small, space saving 4-pin WCSP package. These devices implement a low resistance P-channel MOSFET with a controlled rise time for applications that must limit inrush current.

These devices are designed to have very low leakage current during OFF state. This design prevents downstream circuits from pulling high standby current from the supply. Integrated control logic, driver, power supply, and output discharge FET eliminates the need for additional external components, which reduces solution size and BOM count.

### 8.2 Functional Block Diagram

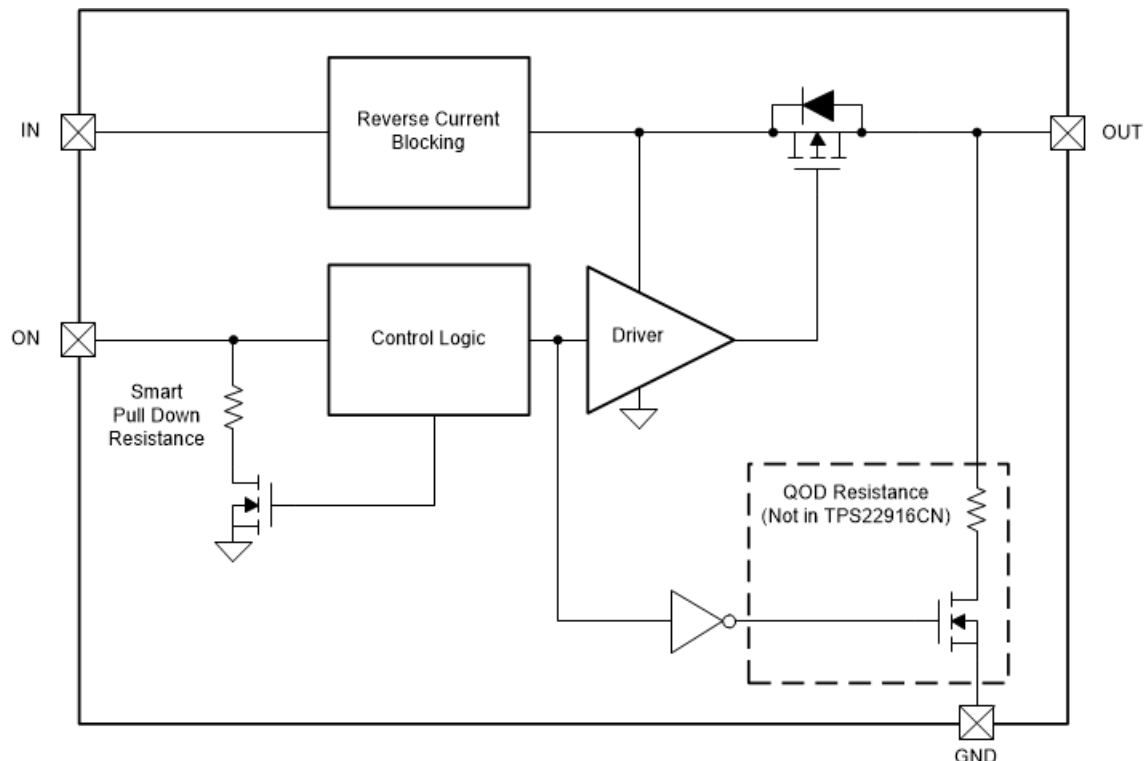

### 8.3 Feature Description

#### 8.3.1 On and Off Control

The ON pin controls the state of the switch. The ON pin is compatible with standard GPIO logic threshold. the pin can be used with any microcontroller with 1.2-V, 1.8-V, 2.5-V, 3.3-V, or 5.5-V GPIO.

#### 8.3.2 Fall Time ( $t_{\text{FALL}}$ ) and Quick Output Discharge (QOD)

The TPS22916B, TPS22916BL, TPS22916C, and TPS22916CL include a Quick Output Discharge feature. When the switch is disabled, a discharge resistor is connected between VOUT and GND. This resistor has a typical value of QOD and prevents the output from floating while the switch is disabled.

As load capacitance and load resistance increase:  $t_{\text{FALL}}$  increases. The larger the load resistance or load capacitance is, the longer it takes to discharge the capacitor, resulting in a longer fall time.



The output fall time is determined by how quickly the load capacitance is discharged and can be found using Equation 1 .

$$t_{\text{FALL}} = - (R_{\text{DIS}}) \times C_L \times \ln (V_{10\%} / V_{90\%}) \quad (1)$$

Where

- $V_{10\%}$  is 10% of the initial output voltage
- $V_{90\%}$  is 90% of the initial output voltage
- $R_{\text{DIS}}$  is the result of the QOD resistance in parallel with the Load Resistance  $R_L$
- $C_L$  is the load capacitance

With the Quick Output Discharge feature, the QOD resistance is in parallel with  $R_L$ . This provides a lower total load resistance as seen from the load capacitance which discharges the capacitance faster resulting in a smaller  $t_{\text{FALL}}$ .

### 8.3.3 Full-Time Reverse Current Blocking

In a scenario where the device is enabled and  $V_{\text{OUT}}$  is greater than  $V_{\text{IN}}$  there is potential for reverse current to flow through the pass FET or the body diode. When the reverse current threshold ( $I_{\text{RCB}}$ ) is exceeded, the switch is disabled within  $t_{\text{RCB}}$ . The switch remains off and block reverse current as long as the reverse voltage condition exists. After  $V_{\text{OUT}}$  has dropped below the  $V_{\text{RCB}}$  release threshold the TPS22916xx turns back on with slew rate control.

## 8.4 Device Functional Modes

Table 8-1 describes the state for each variant as determined by the ON pin.

**Table 8-1. Device Function Table**

ON	TPS22916B	TPS22916BL	TPS22916C	TPS22916CN	TPS22916CL	TPS22916CNL
$\leq V_{\text{IL}}$	Disabled	Enabled	Disabled	Disabled	Enabled	Enabled
$\geq V_{\text{IH}}$	Enabled	Disabled	Enabled	Enabled	Disabled	Disabled

Table 8-2 shows when QOD is active for each variant.

**Table 8-2. QOD Function Table**

Device	TPS22916B	TPS22916BL	TPS22916C	TPS22916CN	TPS22916CL	TPS22916CNL
Enabled	No	No	No	No	No	No
Disabled	Yes	Yes	Yes	No	Yes	No

Table 8-3 shows when the ON pin smart pulldown is active.

**Table 8-3. Smart-ON Pulldown**

$V_{\text{ON}}$	Pulldown
$\leq V_{\text{IL}}$	Connected
$\geq V_{\text{IH}}$	Disconnected

## 9 Application and Implementation

### Note

Information in the following applications sections is not part of the TI component specification, and TI does not warrant its accuracy or completeness. TI's customers are responsible for determining suitability of components for their purposes, as well as validating and testing their design implementation to confirm system functionality.

### 9.1 Application Information

This section highlights some of the design considerations when implementing this device in various applications. A PSPICE model for this device is also available in the product page of this device.

### 9.2 Typical Application

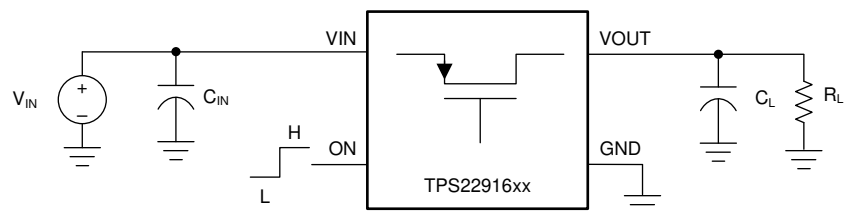

Copyright © 2017, Texas Instruments Incorporated

**Figure 9-1. Typical Application**

#### 9.2.1 Design Requirements

For this design example, below, use the input parameters shown in [Table 9-1](#).

**Table 9-1. Design Parameters**

Design Parameter	Example Value
Input voltage ( $V_{IN}$ )	3.6 V
Load capacitance ( $C_L$ )	47 $\mu$ F
Maximum inrush current ( $I_{RUSH}$ )	300 mA

#### 9.2.2 Detailed Design Procedure

##### 9.2.2.1 Maximum Inrush Current

When the switch is enabled, the output capacitors must be charged up from 0 V to  $V_{IN}$  voltage. This charge arrives in the form of inrush current. Inrush current can be calculated using the following equation:

$$I_{RUSH} = C_L \times SR_{ON} \quad (2)$$

$$I_{RUSH} = 47 \mu\text{F} \times 3.2 \text{ mV}/\mu\text{s} \quad (3)$$

$$I_{RUSH} = 150 \text{ mA} \quad (4)$$

The TPS22916x offers multiple rise time options to control the inrush current during turn-on. The appropriate device can be selected based upon the maximum acceptable slew rate which can be calculated using the design requirements and the inrush current equation. In this case, the TPS22916C provides a slew rate slow enough to limit the inrush current to the desired amount.

### 9.2.3 Application Curve

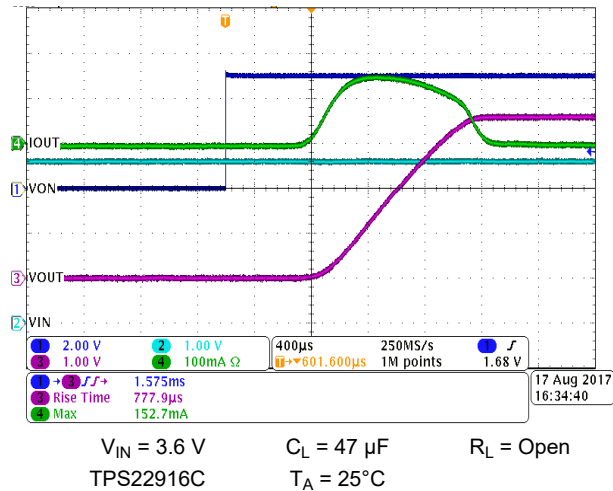

**Figure 9-2. Inrush Current**

## 10 Power Supply Recommendations

The device is designed to operate with a V<sub>IN</sub> range of 1 V to 5.5 V. The V<sub>IN</sub> power supply must be well regulated and placed as close to the device terminal as possible. The power supply must be able to withstand all transient load current steps. In most situations, using an input capacitance (C<sub>IN</sub>) of 1 µF is sufficient to prevent the supply voltage from dipping when the switch is turned on. In cases where the power supply is slow to respond to a large transient current or large load current step, additional bulk capacitance can be required on the input.

## 11 Layout

### 11.1 Layout Guidelines

For best performance, all traces must be as short as possible. To be most effective, the input and output capacitors must be placed close to the device to minimize the effects that parasitic trace inductances can have on normal operation. Using wide traces for VIN, VOUT, and GND helps minimize the parasitic electrical effects.

### 11.2 Layout Example

Equation 3 shows an example for these devices. Notice the connection to system ground between the V<sub>OUT</sub> Bypass Capacitor ground and the GND pin of the load switch,. This connection creates a ground barrier which helps to reduce the ground noise seen by the device.

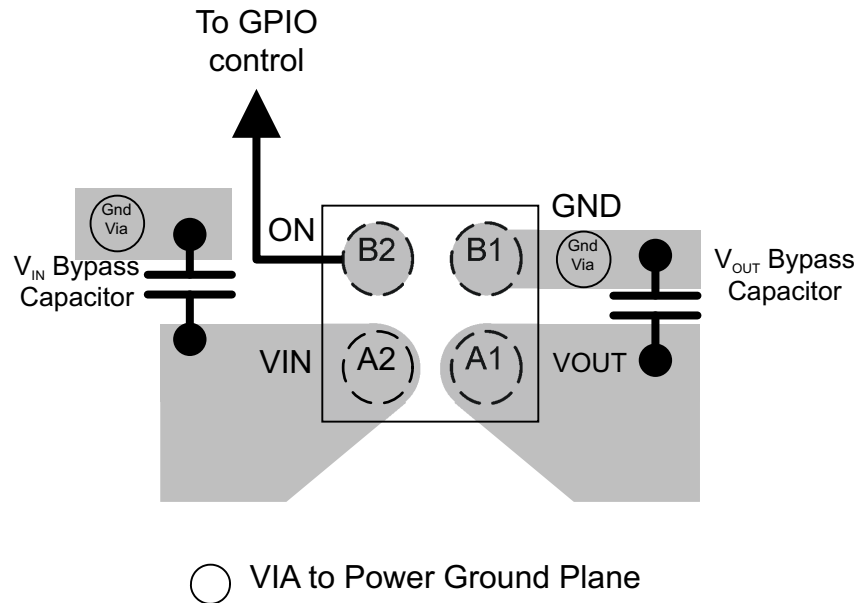

**Figure 11-1. TPS22916xx Layout**

### 11.3 Thermal Considerations

The maximum IC junction temperature must be restricted to 125°C under normal operating conditions. To calculate the maximum allowable dissipation, P<sub>D(max)</sub> for a given output current and ambient temperature, use Equation 5 as a guideline:

$$P_{D(\text{MAX})} = \frac{T_{J(\text{MAX})} - T_A}{R_{\theta\text{JA}}} \quad (5)$$

Where,

P<sub>D(max)</sub> = maximum allowable power dissipation

T<sub>J(max)</sub> = maximum allowable junction temperature

T<sub>A</sub> = ambient temperature for the device

θ<sub>JA</sub> = junction to air thermal impedance. See the [Thermal Information](#) section.

## 12 Device and Documentation Support

### 12.1 Documentation Support

#### 12.1.1 Related Documentation

For related documentation see the following:

Texas Instruments, [TPS22916 Load Switch Evaluation Module User's Guide](#)

### 12.2 Receiving Notification of Documentation Updates

To receive notification of documentation updates, navigate to the device product folder on [ti.com](#). Click on *Subscribe to updates* to register and receive a weekly digest of any product information that has changed. For change details, review the revision history included in any revised document.

### 12.3 Support Resources

[TI E2E™ support forums](#) are an engineer's go-to source for fast, verified answers and design help — straight from the experts. Search existing answers or ask your own question to get the quick design help you need.

Linked content is provided "AS IS" by the respective contributors. They do not constitute TI specifications and do not necessarily reflect TI's views; see TI's [Terms of Use](#).

### 12.4 Trademarks

TI E2E™ is a trademark of Texas Instruments.

All trademarks are the property of their respective owners.

### 12.5 Electrostatic Discharge Caution



This integrated circuit can be damaged by ESD. Texas Instruments recommends that all integrated circuits be handled with appropriate precautions. Failure to observe proper handling and installation procedures can cause damage.

ESD damage can range from subtle performance degradation to complete device failure. Precision integrated circuits may be more susceptible to damage because very small parametric changes could cause the device not to meet its published specifications.

### 12.6 Glossary

[TI Glossary](#) This glossary lists and explains terms, acronyms, and definitions.

## 13 Mechanical, Packaging, and Orderable Information

The following pages include mechanical, packaging, and orderable information. This information is the most current data available for the designated devices. This data is subject to change without notice and revision of this document. For browser-based versions of this data sheet, refer to the left-hand navigation.

### 13.1 Tape and Reel Information

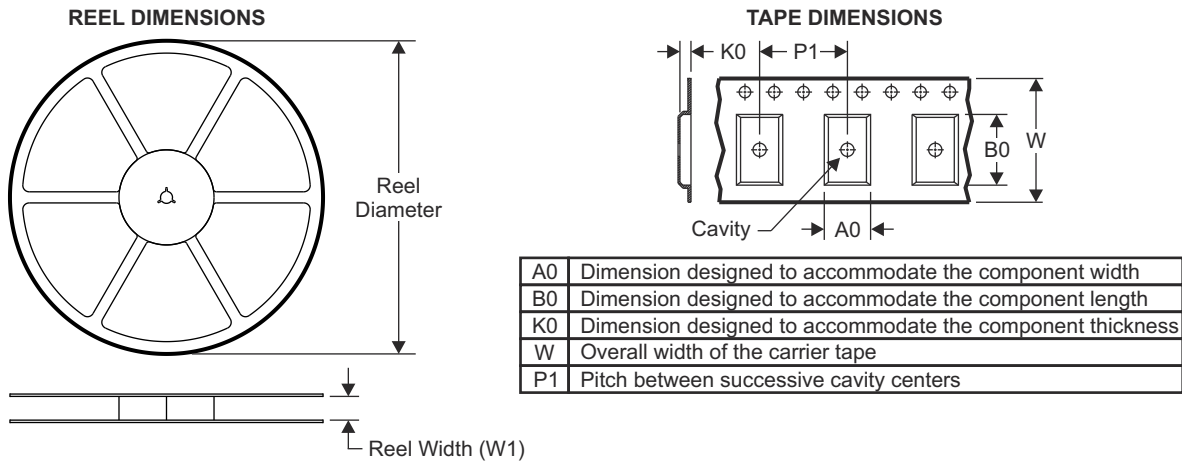

#### QUADRANT ASSIGNMENTS FOR PIN 1 ORIENTATION IN TAPE

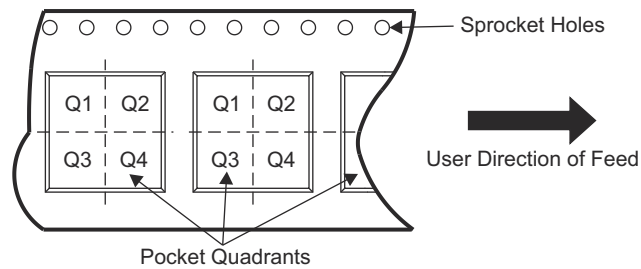

Device	Package Type	Package Drawing	Pins	SPQ	Reel Diameter (mm)	Reel Width W1 (mm)	A0 (mm)	B0 (mm)	K0 (mm)	P1 (mm)	W (mm)	Pin1 Quadrant
TPS22916BYFPR	DSBGA	YFP	4	3000	180.0	8.4	0.86	0.86	0.59	4.0	8.0	Q1
TPS22916BYFPT	DSBGA	YFP	4	250	180.0	8.4	0.86	0.86	0.59	4.0	8.0	Q1
TPS22916CLYFPR	DSBGA	YFP	4	3000	180.0	8.4	0.86	0.86	0.59	4.0	8.0	Q1
TPS22916CLYFPT	DSBGA	YFP	4	250	180.0	8.4	0.86	0.86	0.59	4.0	8.0	Q1
TPS22916CNYFPR	DSBGA	YFP	4	3000	180.0	8.4	0.86	0.86	0.59	4.0	8.0	Q1
TPS22916CNYFPT	DSBGA	YFP	4	250	180.0	8.4	0.86	0.86	0.59	4.0	8.0	Q1
TPS22916CYFPR	DSBGA	YFP	4	3000	180.0	8.4	0.86	0.86	0.59	4.0	8.0	Q1
TPS22916CYFPT	DSBGA	YFP	4	250	180.0	8.4	0.86	0.86	0.59	4.0	8.0	Q1
TPS22916CNLYFPR	DSBGA	YFP	4	3000	180.0	8.4	0.86	0.86	0.59	4.0	8.0	Q1
TPS22916BLYFPR	DSBGA	YFP	4	3000	180.0	8.4	0.86	0.86	0.59	4.0	8.0	Q1

**TAPE AND REEL BOX DIMENSIONS**

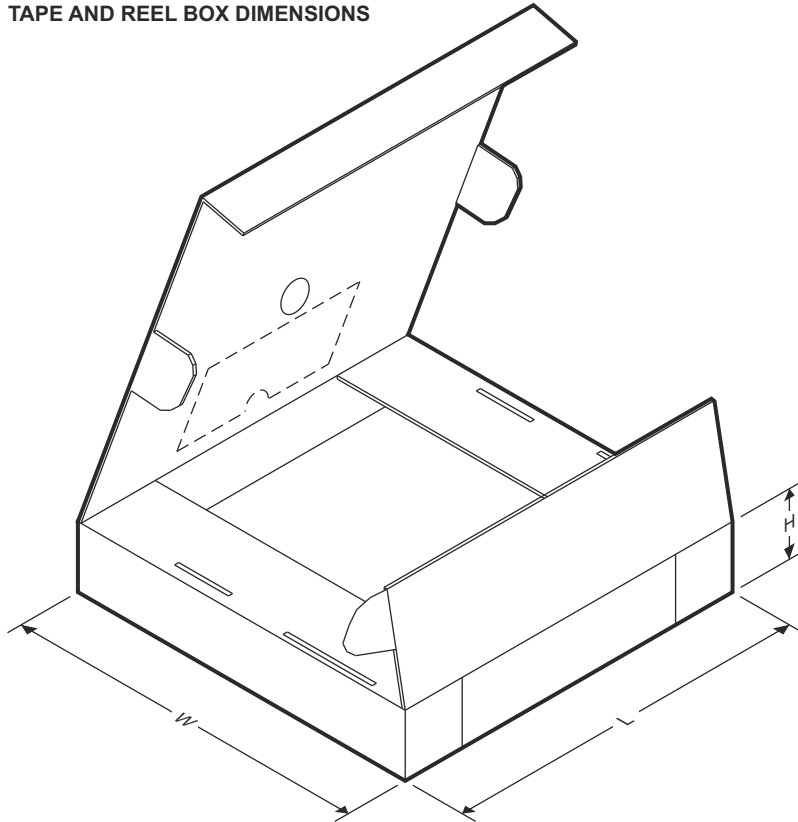

Device	Package Type	Package Drawing	Pins	SPQ	Length (mm)	Width (mm)	Height (mm)
TPS22916BYFPR	DSBGA	YFP	4	3000	182.0	182.0	20.0
TPS22916BYFPT	DSBGA	YFP	4	250	182.0	182.0	20.0
TPS22916CLYFPR	DSBGA	YFP	4	3000	182.0	182.0	20.0
TPS22916CLYFPT	DSBGA	YFP	4	250	182.0	182.0	20.0
TPS22916CNYFPR	DSBGA	YFP	4	3000	182.0	182.0	20.0
TPS22916CNYFPT	DSBGA	YFP	4	250	182.0	182.0	20.0
TPS22916CYFPR	DSBGA	YFP	4	3000	182.0	182.0	20.0
TPS22916CYFPT	DSBGA	YFP	4	250	182.0	182.0	20.0
TPS22916CNLYFPR	DSBGA	YFP	4	3000	182.0	182.0	20.0
TPS22916BLYFPR	DSBGA	YFP	4	3000	182.0	182.0	20.0



**YFP0004**

**PACKAGE OUTLINE**

**DSBGA - 0.5 mm max height**

DIE SIZE BALL GRID ARRAY

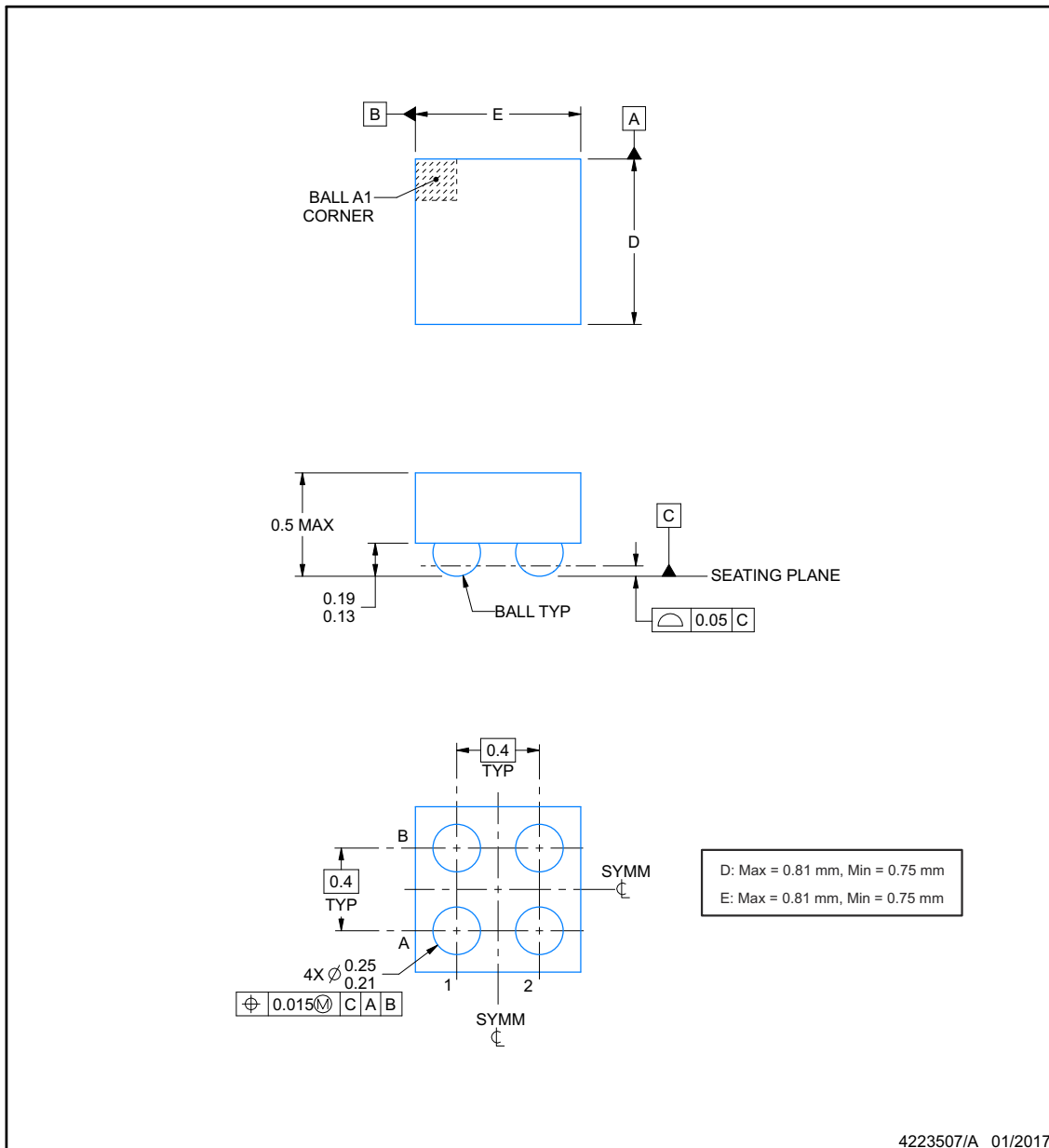

NOTES:

1. All linear dimensions are in millimeters. Any dimensions in parenthesis are for reference only. Dimensioning and tolerancing per ASME Y14.5M.
2. This drawing is subject to change without notice.



## EXAMPLE BOARD LAYOUT

**YFP0004**

**DSBGA - 0.5 mm max height**

DIE SIZE BALL GRID ARRAY

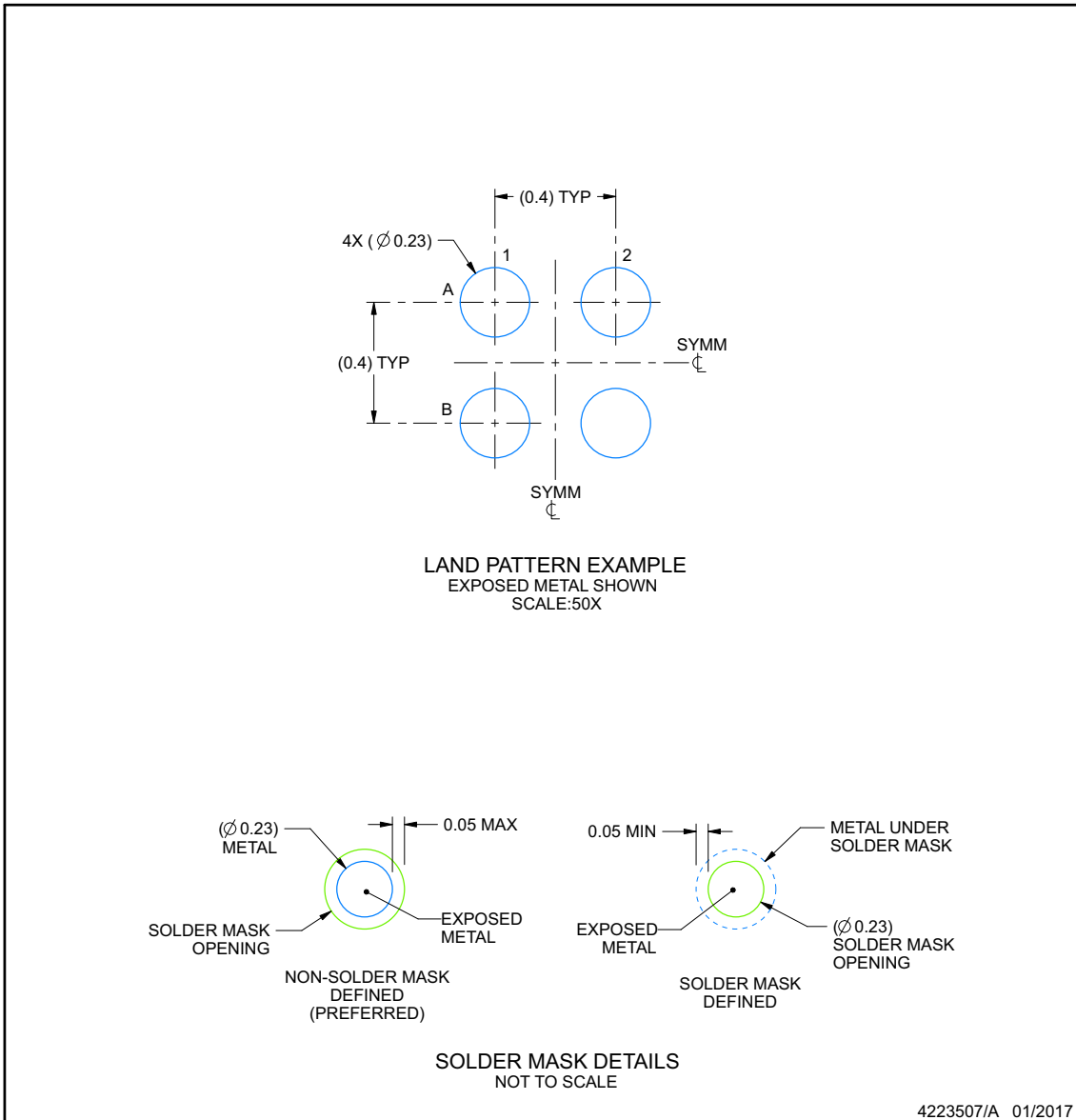

NOTES: (continued)

- Final dimensions may vary due to manufacturing tolerance considerations and also routing constraints. For more information, see Texas Instruments literature number SNVA009 ([www.ti.com/lit/snva009](http://www.ti.com/lit/snva009)).

**EXAMPLE STENCIL DESIGN**

**YFP0004**

**DSBGA - 0.5 mm max height**

DIE SIZE BALL GRID ARRAY

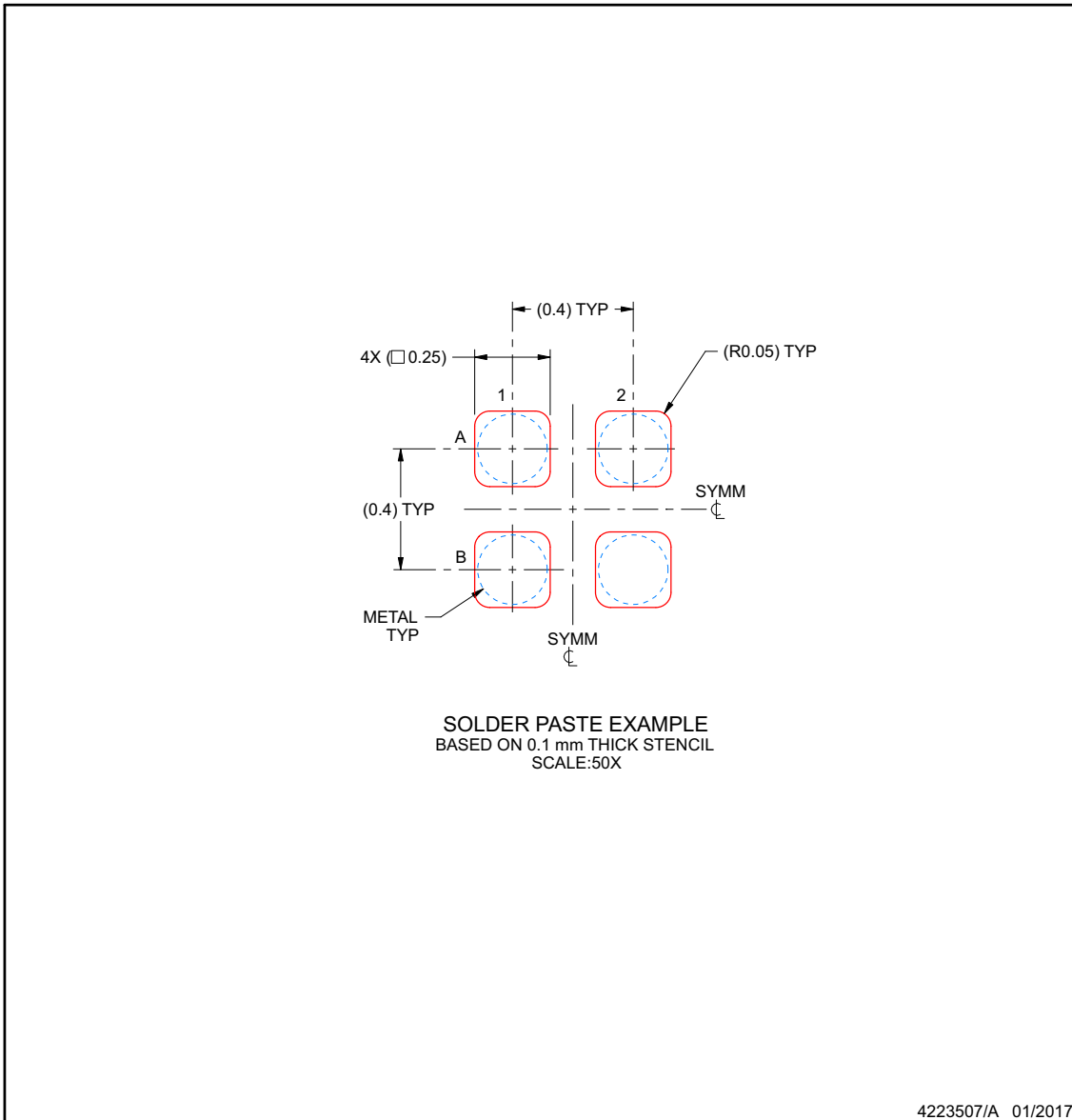

NOTES: (continued)

- 4. Laser cutting apertures with trapezoidal walls and rounded corners may offer better paste release.

## PACKAGING INFORMATION

Orderable Device	Status (1)	Package Type	Package Drawing	Pins	Package Qty	Eco Plan (2)	Lead finish/ Ball material (6)	MSL Peak Temp (3)	Op Temp (°C)	Device Marking (4/5)	Samples
TPS22916BLYFPR	ACTIVE	DSBGA	YFP	4	3000	RoHS & Green	SNAGCU	Level-1-260C-UNLIM	-40 to 85	Q	<a href="#">Samples</a>
TPS22916BYFPR	ACTIVE	DSBGA	YFP	4	3000	RoHS & Green	SAC396   SNAGCU	Level-1-260C-UNLIM	-40 to 85	(BA, R)	<a href="#">Samples</a>
TPS22916BYFPT	ACTIVE	DSBGA	YFP	4	250	RoHS & Green	SAC396   SNAGCU	Level-1-260C-UNLIM	-40 to 85	(BA, R)	<a href="#">Samples</a>
TPS22916CLYFPR	ACTIVE	DSBGA	YFP	4	3000	RoHS & Green	SAC396	Level-1-260C-UNLIM	-40 to 85	B9	<a href="#">Samples</a>
TPS22916CLYFPT	ACTIVE	DSBGA	YFP	4	250	RoHS & Green	SAC396	Level-1-260C-UNLIM	-40 to 85	B9	<a href="#">Samples</a>
TPS22916CNLYFPR	ACTIVE	DSBGA	YFP	4	3000	RoHS & Green	SNAGCU	Level-1-260C-UNLIM	-40 to 85	S	<a href="#">Samples</a>
TPS22916CNYFPR	ACTIVE	DSBGA	YFP	4	3000	RoHS & Green	SAC396	Level-1-260C-UNLIM	-40 to 85	B8	<a href="#">Samples</a>
TPS22916CNYFPT	ACTIVE	DSBGA	YFP	4	250	RoHS & Green	SAC396	Level-1-260C-UNLIM	-40 to 85	B8	<a href="#">Samples</a>
TPS22916CYFPR	ACTIVE	DSBGA	YFP	4	3000	RoHS & Green	SAC396	Level-1-260C-UNLIM	-40 to 85	B7	<a href="#">Samples</a>
TPS22916CYFPT	ACTIVE	DSBGA	YFP	4	250	RoHS & Green	SAC396	Level-1-260C-UNLIM	-40 to 85	B7	<a href="#">Samples</a>

(1) The marketing status values are defined as follows:

**ACTIVE:** Product device recommended for new designs.

**LIFEBUY:** TI has announced that the device will be discontinued, and a lifetime-buy period is in effect.

**NRND:** Not recommended for new designs. Device is in production to support existing customers, but TI does not recommend using this part in a new design.

**PREVIEW:** Device has been announced but is not in production. Samples may or may not be available.

**OBSOLETE:** TI has discontinued the production of the device.

(2) **RoHS:** TI defines "RoHS" to mean semiconductor products that are compliant with the current EU RoHS requirements for all 10 RoHS substances, including the requirement that RoHS substance do not exceed 0.1% by weight in homogeneous materials. Where designed to be soldered at high temperatures, "RoHS" products are suitable for use in specified lead-free processes. TI may reference these types of products as "Pb-Free".

**RoHS Exempt:** TI defines "RoHS Exempt" to mean products that contain lead but are compliant with EU RoHS pursuant to a specific EU RoHS exemption.

**Green:** TI defines "Green" to mean the content of Chlorine (Cl) and Bromine (Br) based flame retardants meet JS709B low halogen requirements of <=1000ppm threshold. Antimony trioxide based flame retardants must also meet the <=1000ppm threshold requirement.

(3) MSL, Peak Temp. - The Moisture Sensitivity Level rating according to the JEDEC industry standard classifications, and peak solder temperature.

(4) There may be additional marking, which relates to the logo, the lot trace code information, or the environmental category on the device.

<sup>(5)</sup> Multiple Device Markings will be inside parentheses. Only one Device Marking contained in parentheses and separated by a "~" will appear on a device. If a line is indented then it is a continuation of the previous line and the two combined represent the entire Device Marking for that device.

<sup>(6)</sup> Lead finish/Ball material - Orderable Devices may have multiple material finish options. Finish options are separated by a vertical ruled line. Lead finish/Ball material values may wrap to two lines if the finish value exceeds the maximum column width.

**Important Information and Disclaimer:**The information provided on this page represents TI's knowledge and belief as of the date that it is provided. TI bases its knowledge and belief on information provided by third parties, and makes no representation or warranty as to the accuracy of such information. Efforts are underway to better integrate information from third parties. TI has taken and continues to take reasonable steps to provide representative and accurate information but may not have conducted destructive testing or chemical analysis on incoming materials and chemicals. TI and TI suppliers consider certain information to be proprietary, and thus CAS numbers and other limited information may not be available for release.

In no event shall TI's liability arising out of such information exceed the total purchase price of the TI part(s) at issue in this document sold by TI to Customer on an annual basis.

## IMPORTANT NOTICE AND DISCLAIMER

TI PROVIDES TECHNICAL AND RELIABILITY DATA (INCLUDING DATA SHEETS), DESIGN RESOURCES (INCLUDING REFERENCE DESIGNS), APPLICATION OR OTHER DESIGN ADVICE, WEB TOOLS, SAFETY INFORMATION, AND OTHER RESOURCES "AS IS" AND WITH ALL FAULTS, AND DISCLAIMS ALL WARRANTIES, EXPRESS AND IMPLIED, INCLUDING WITHOUT LIMITATION ANY IMPLIED WARRANTIES OF MERCHANTABILITY, FITNESS FOR A PARTICULAR PURPOSE OR NON-INFRINGEMENT OF THIRD PARTY INTELLECTUAL PROPERTY RIGHTS.

These resources are intended for skilled developers designing with TI products. You are solely responsible for (1) selecting the appropriate TI products for your application, (2) designing, validating and testing your application, and (3) ensuring your application meets applicable standards, and any other safety, security, regulatory or other requirements.

These resources are subject to change without notice. TI grants you permission to use these resources only for development of an application that uses the TI products described in the resource. Other reproduction and display of these resources is prohibited. No license is granted to any other TI intellectual property right or to any third party intellectual property right. TI disclaims responsibility for, and you will fully indemnify TI and its representatives against, any claims, damages, costs, losses, and liabilities arising out of your use of these resources.

TI's products are provided subject to [TI's Terms of Sale](#) or other applicable terms available either on [ti.com](http://ti.com) or provided in conjunction with such TI products. TI's provision of these resources does not expand or otherwise alter TI's applicable warranties or warranty disclaimers for TI products.

TI objects to and rejects any additional or different terms you may have proposed.

Mailing Address: Texas Instruments, Post Office Box 655303, Dallas, Texas 75265  
Copyright © 2022, Texas Instruments Incorporated