

## 2-CHANNEL ESD SOLUTION FOR HIGH-SPEED (6 GBPS) DIFFERENTIAL INTERFACE

### FEATURES

- 0.05-pF Matching Capacitance Between the Differential Signal Pair
- Single-Pair Differential Lines to Protect the Differential Data and Clock Lines of the LVDS, SATA, Ethernet, or USB High-Speed (HS) Interface
- Flow-Through Pin Mapping for the High-Speed Lines Ensures Zero Additional Skew Due to Board Layout While Placing ESD-Protection Chip Near the Connector
- Supports Data Rates in Excess of 6 Gbps
- ESD Protection Meets or Exceeds IEC61000-4-2 (Level 4)
- 5-A Peak Pulse Current (8/20  $\mu$ s Pulse) for  $V_{BUS}$  and D+, D–, and ID Lines
- Industrial Temperature Range: –40°C to 85°C
- Multiple Space-Saving Package Options

### APPLICATIONS

- Notebooks
- Set-Top Boxes
- DVD Players
- Media Players
- Portable Computers

### DESCRIPTION/ORDERING INFORMATION

The TPD2E009 provides 2 ESD clamp circuits with flow-through pin mapping for ease of board layout. This device has been designed to protect sensitive components which are connected to ultra high-speed data and transmission lines. The TPD2E009 offers protection from stress caused by ESD (electrostatic discharge). This device also offers 5 A (8/20  $\mu$ s) peak pulse current ratings per IEC 61000-4-5 (lightning) specification.

The monolithic silicon technology allows matching between the differential signal pairs. The less than differential 0.05-pF capacitance ensures that the differential signal distortion due to added ESD clamp remains minimal. The 0.7-pF line capacitance is suitable for high-speed data rate (in excess of 6 Gbps).

The TPD2E009 conforms to IEC61000-4-2 (Level 4) ESD protection. The DRT (1 mm  $\times$  1 mm) package is offered for space-saving portable applications. The industry standard DBZ (2.4 mm  $\times$  2.9 mm) package offers additional flexibility in the board layout for the system designer.

The TPD2E009 is characterized for operation over ambient air temperature range of –40°C to 85°C.

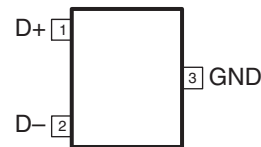
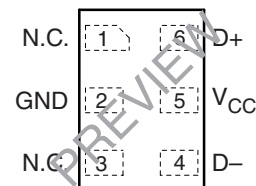
**DBZ/DRT PACKAGE  
(TOP VIEW)**

**DRY PACKAGE  
(TOP VIEW)**

N.C. – No internal connection



Please be aware that an important notice concerning availability, standard warranty, and use in critical applications of Texas Instruments semiconductor products and disclaimers thereto appears at the end of this data sheet.

**ORDERING INFORMATION**

T <sub>A</sub>	PACKAGE <sup>(1)(2)</sup>		ORDERABLE PART NUMBER	TOP-SIDE MARKING
–40°C to 85°C	SON – DRY	Tape and reel	TPD2E009DRYR	PREVIEW
	SOP – DBZ	Tape and reel	TPD2E009DBZR	NFLR
	SOT– DRT	Tape and reel	TPD2E009DRTR	4T

- (1) Package drawings, thermal data, and symbolization are available at [www.ti.com/packaging](http://www.ti.com/packaging).
- (2) For the most current package and ordering information, see the Package Option Addendum at the end of this document, or see the TI website at [www.ti.com](http://www.ti.com).

**CIRCUIT DIAGRAMS**

**DRY Circuit**

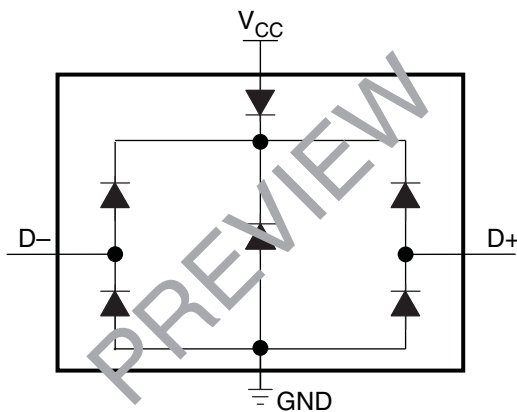

**DBZ/DRT Circuit**

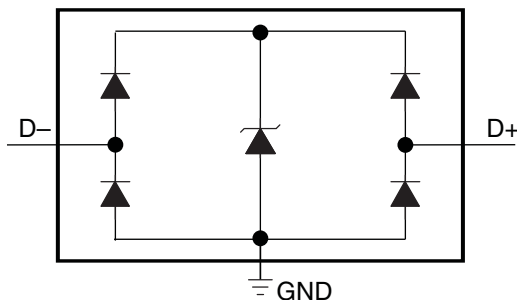

**TERMINAL FUNCTIONS**

NAME	TERMINAL		TYPE	DESCRIPTION
	DBZ/DRT PIN NO.	DRY <sup>(1)</sup> PIN NO.		
D+, D-	1, 2	4, 6	ESD port	High-speed ESD clamp, provides ESD protection to the high-speed differential data lines
V <sub>CC</sub>	–	5	Supply	Power supply
GND	3	3	GND	Ground

(1) Product Preview

## ABSOLUTE MAXIMUM RATINGS<sup>(1)</sup>

over operating free-air temperature range (unless otherwise noted)

			MIN	MAX	UNIT
	IO voltage tolerance	D+, D– pins	0	6	
T <sub>A</sub>	Operating free-air temperature range		–40	85	°C
T <sub>stg</sub>	Storage temperature range		–65	125	°C
ESD protection	IEC 61000-4-2 Contact Discharge	D+, D– pins		±8	kV
	IEC 61000-4-2 Air-Gap Discharge	D+, D– pins		±8	kV
	Peak pulse current (t <sub>p</sub> = 8/20 μs)	D+, D– pins		5	A
	Peak pulse power (t <sub>p</sub> = 8/20 μs)	D+, D– pins		45	W

(1) Stresses beyond those listed under "absolute maximum ratings" may cause permanent damage to the device. These are stress ratings only, and functional operation of the device at these or any other conditions beyond those indicated in the operational sections of the specifications is not implied. Exposure to absolute maximum-rated conditions for extended periods may affect device reliability.

## ELECTRICAL CHARACTERISTICS

over operating free-air temperature range (unless otherwise noted)

PARAMETER		TEST CONDITIONS		MIN	TYP	MAX	UNIT
V <sub>RWM</sub>	Reverse stand-off voltage	D+,D– pins to ground				5.5	V
V <sub>clamp</sub>	Clamp voltage	D+,D– pins to ground, I <sub>IO</sub> = 1 A				8	V
I <sub>IO</sub>	Current from IO port to supply pins	V <sub>IO</sub> = 2.5 V, I <sub>D</sub> = 8 mA			0.01	0.1	μA
V <sub>D</sub>	Diode forward voltage	D+,D– pins, lower clamp diode,	V <sub>IO</sub> = 2.5 V, I <sub>D</sub> = 8 mA	0.6	0.8	0.95	V
		D+,D– pins, upper clamp diode, DRY package	V <sub>CC</sub> = 0 V, I <sub>D</sub> = –8 mA	0.6	0.8	0.95	
R <sub>dyn</sub>	Dynamic resistance	D+,D– pins, I = 1 A			1		Ω
C <sub>IO</sub>	IO capacitance	D+,D– pins, DBZ Package		V <sub>IO</sub> = 2.5 V		0.9	pF
		D+,D– pins, DRT Package		V <sub>IO</sub> = 2.5 V		0.7	pF
V <sub>BR</sub>	Break-down voltage	I <sub>IO</sub> = 1 mA		7			V

TYPICAL OPERATING CHARACTERISTICS

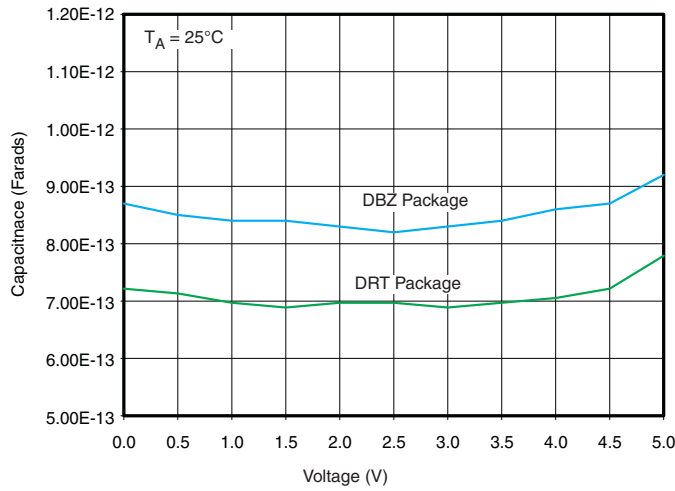

Figure 1. IO Capacitance vs IO Voltage

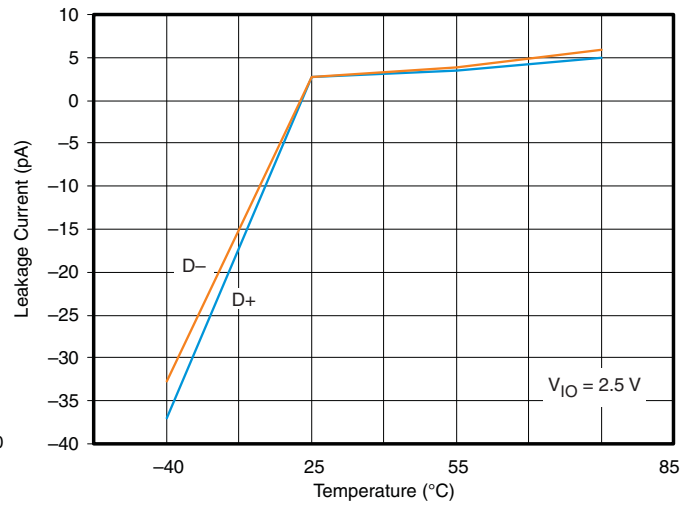

Figure 2. Leakage Current vs Temperature

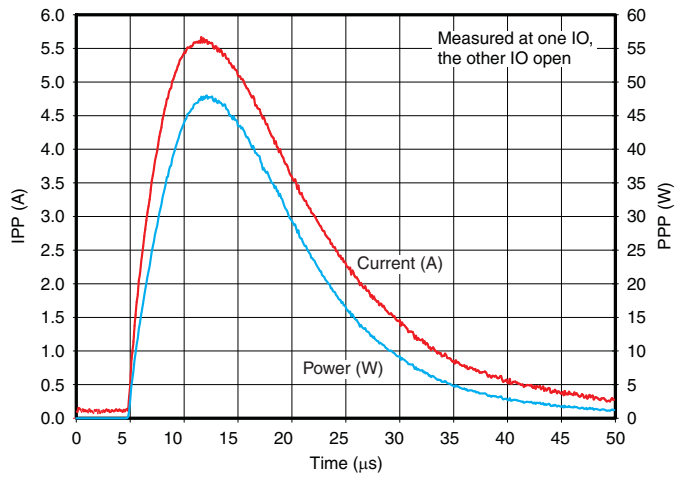

Figure 3. Peak Pulse Waveforms

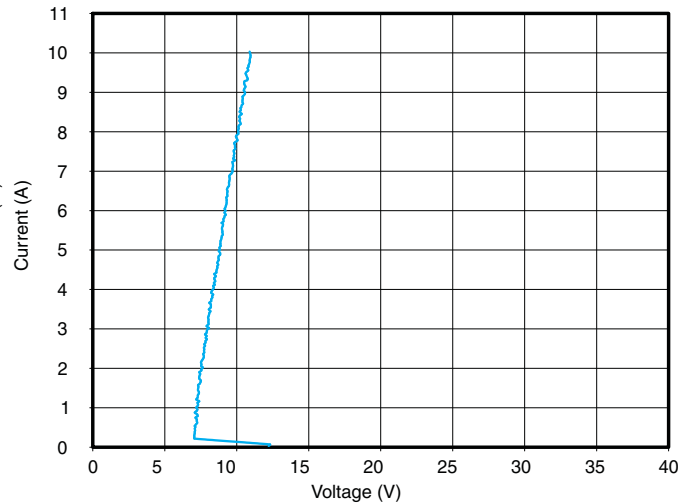

Figure 4. D+, D- Transmission Line Pulsar Plot (100 ns Pulse, 10 ns Rise Time)

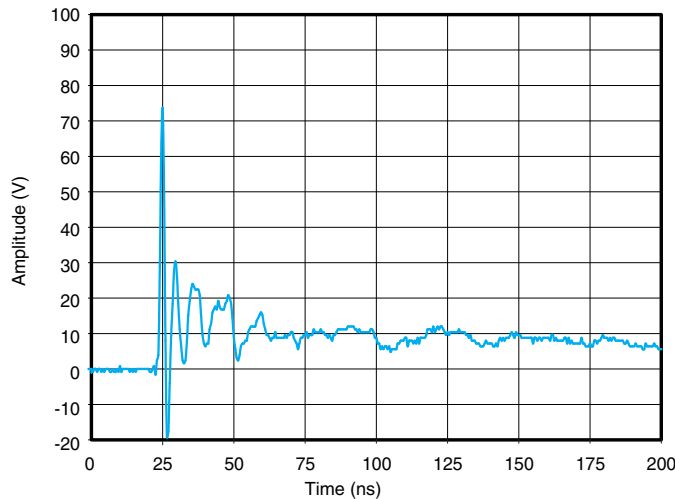

Figure 5. IEC Clamping Waveforms (8 kV Contact)

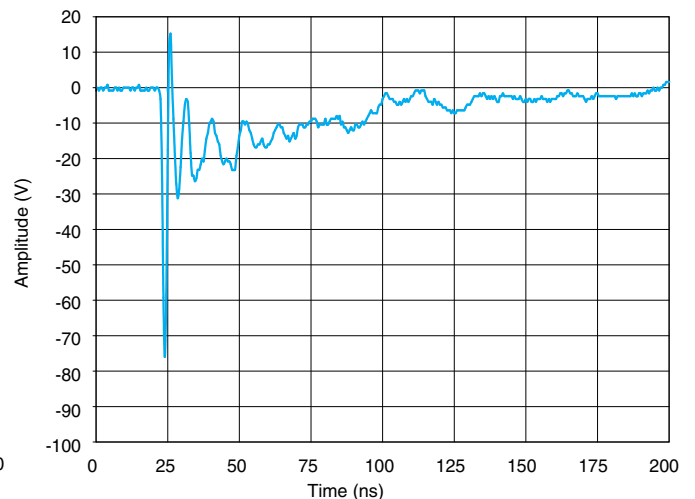

Figure 6. IEC Clamping Waveforms (-8 kV Contact)

TYPICAL OPERATING CHARACTERISTICS (continued)

Eye Diagrams

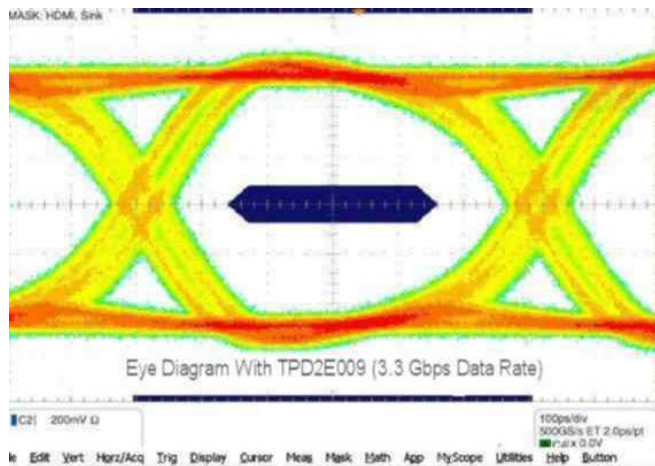

Figure 7. Eye Diagram With TPD2E009 (3.3 Gbps Data Rate) (3-Pin DBZ Package)

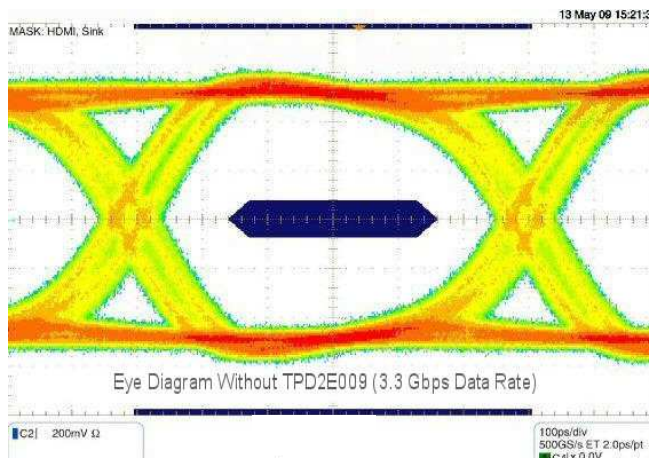

Figure 8. Eye Diagram Without TPD2E009 (3.3 Gbps Data Rate) (3-Pin DBZ Package)

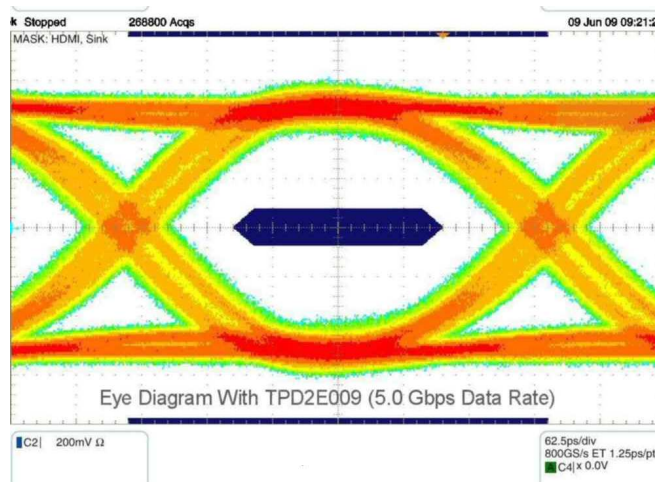

Figure 9. Eye Diagram With TPD2E009 (5.0 Gbps Data Rate) (3-Pin DBZ Package)

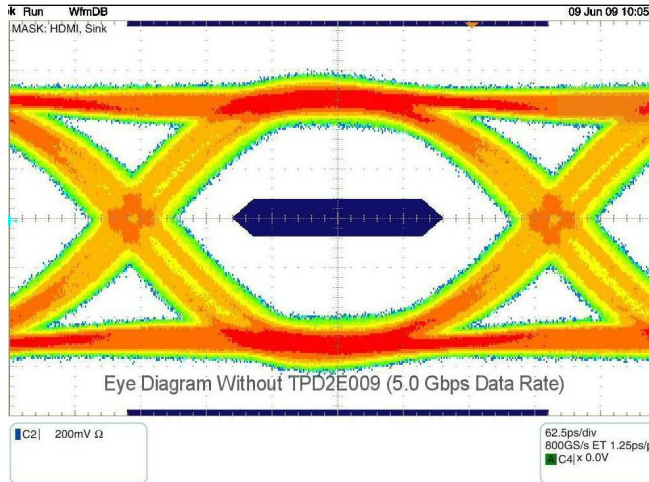
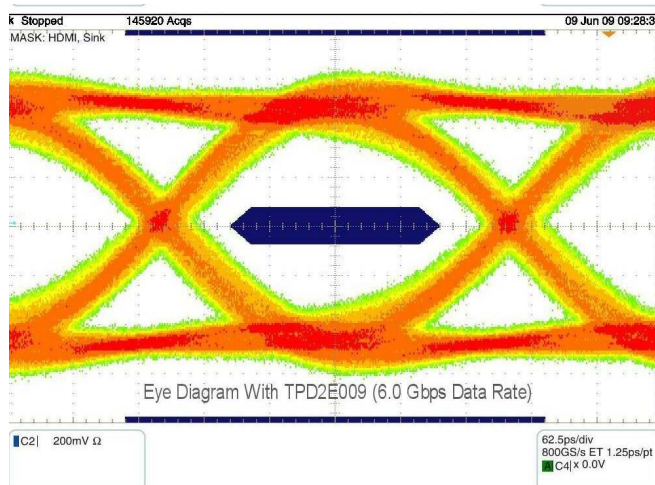
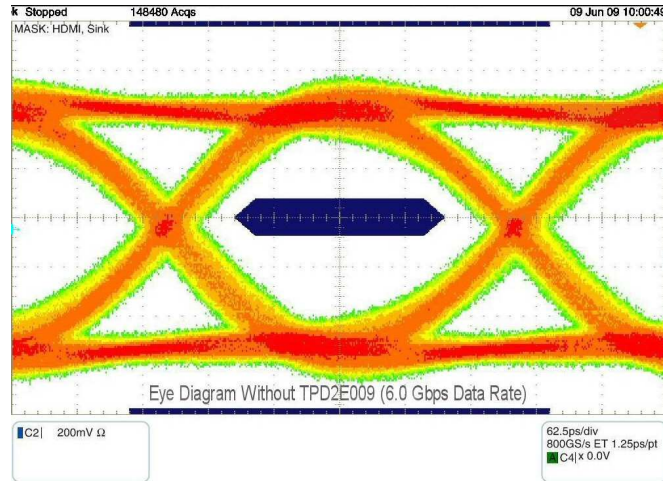

Figure 10. Eye Diagram Without TPD2E009 (5.0 Gbps Data Rate) (3-Pin DBZ Package)

TYPICAL OPERATING CHARACTERISTICS (continued)



**Figure 11. Eye Diagram With TPD2E009  
(6.0 Gbps Data Rate)  
(3-Pin DBZ Package)**



**Figure 12. Eye Diagram Without TPD2E009  
(6.0 Gbps Data Rate)  
(3-Pin DBZ Package)**

## APPLICATION INFORMATION

### Typical Application

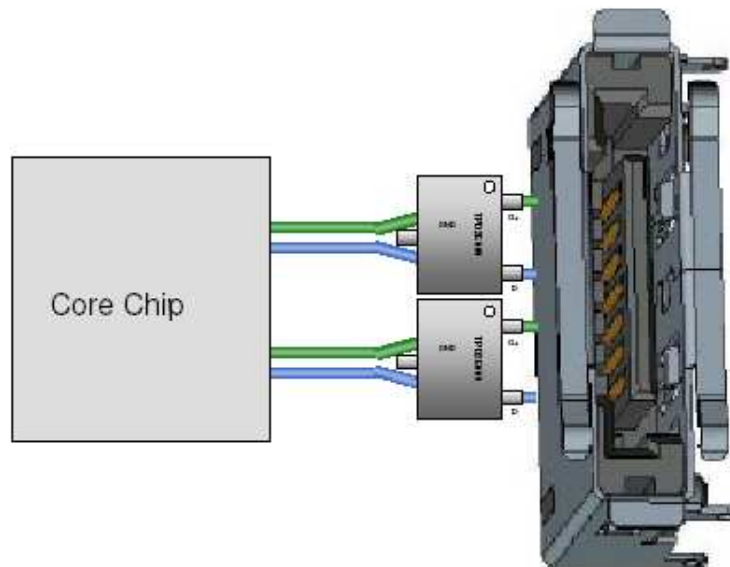

**Figure 13. TPD2E009 in Differential eSATA Interface**

Figure 13 shows the board layout scheme for the D+/D- lines of a single differential pair. It allows the differential signal pairs couple together right after they touch the ESD ports (pin 1 and pin 2) of the TPD2E009.

### Designing with High-Speed Differential Signals

Layout considerations, such as package selection, trace routing, etc. must be taken into account while designing the ESD clamp circuit for high-speed interface. Difficult routing can lead the designer to use vias or stubs in the board traces, creating significant disruption in the line impedance in the high-speed signal path. Poor package choice can force designer to route differential traces with unequal lengths and add the skew in the signals. It is recommended to closely couple the differential traces to reduce the EMI interference.

The TPD2E009 can provide system level ESD protection to the high-speed differential ports (>6 Gbps data rate). The flow-through package offers flexibility for board routing with traces up to 15 mills wide. Figure 14 and Figure 15 show the board layout scheme for the D+/D- lines of a single differential pair. It allows the differential signal pairs couple together right after they touch the ESD ports (pin 1 and pin 2) of the TPD2E009.

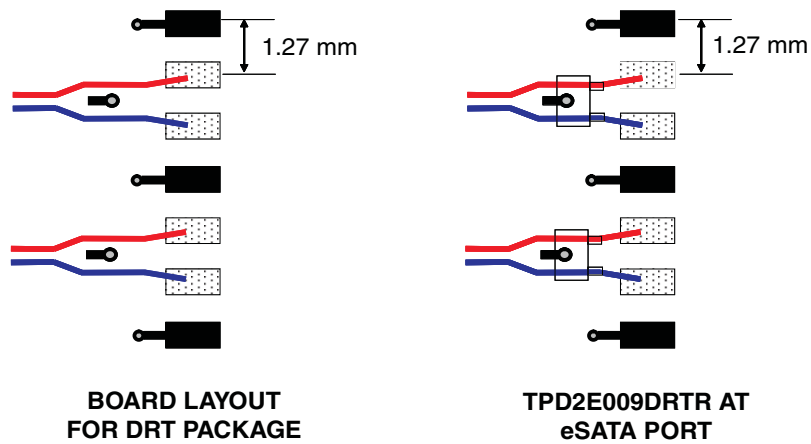

Figure 14. TPD2E009DRTR at eSATA Connector Interface

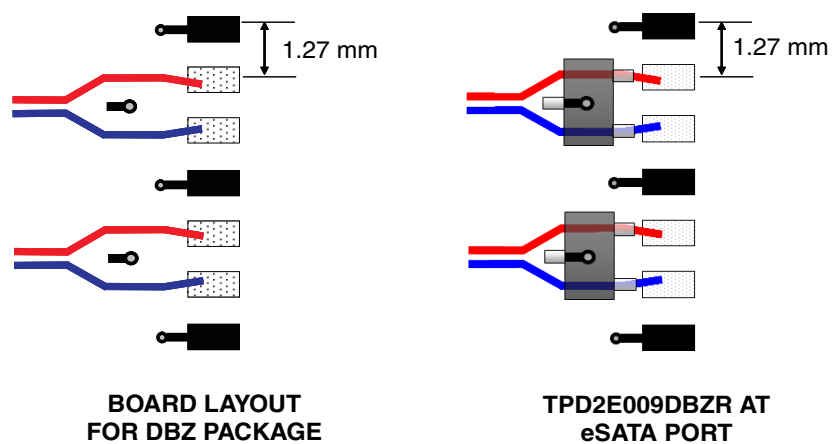

Figure 15. TPD2E009DBZR at eSATA Connector Interface



**PACKAGING INFORMATION**

Orderable Device	Status <sup>(1)</sup>	Package Type	Package Drawing	Pins	Package Qty	Eco Plan <sup>(2)</sup>	Lead/ Ball Finish	MSL Peak Temp <sup>(3)</sup>	Samples (Requires Login)
TPD2E009DBZR	ACTIVE	SOT-23	DBZ	3	3000	Green (RoHS & no Sb/Br)	CU NIPDAU	Level-1-260C-UNLIM	
TPD2E009DRTR	ACTIVE	SOT	DRT	3	3000	Green (RoHS & no Sb/Br)	CU NIPDAU	Level-1-260C-UNLIM	
TPD2E009DRYR	PREVIEW	SON	DRY	6	5000	TBD	Call TI	Call TI	

<sup>(1)</sup> The marketing status values are defined as follows:

**ACTIVE:** Product device recommended for new designs.

**LIFEBUY:** TI has announced that the device will be discontinued, and a lifetime-buy period is in effect.

**NRND:** Not recommended for new designs. Device is in production to support existing customers, but TI does not recommend using this part in a new design.

**PREVIEW:** Device has been announced but is not in production. Samples may or may not be available.

**OBSOLETE:** TI has discontinued the production of the device.

<sup>(2)</sup> Eco Plan - The planned eco-friendly classification: Pb-Free (RoHS), Pb-Free (RoHS Exempt), or Green (RoHS & no Sb/Br) - please check <http://www.ti.com/productcontent> for the latest availability information and additional product content details.

**TBD:** The Pb-Free/Green conversion plan has not been defined.

**Pb-Free (RoHS):** TI's terms "Lead-Free" or "Pb-Free" mean semiconductor products that are compatible with the current RoHS requirements for all 6 substances, including the requirement that lead not exceed 0.1% by weight in homogeneous materials. Where designed to be soldered at high temperatures, TI Pb-Free products are suitable for use in specified lead-free processes.

**Pb-Free (RoHS Exempt):** This component has a RoHS exemption for either 1) lead-based flip-chip solder bumps used between the die and package, or 2) lead-based die adhesive used between the die and leadframe. The component is otherwise considered Pb-Free (RoHS compatible) as defined above.

**Green (RoHS & no Sb/Br):** TI defines "Green" to mean Pb-Free (RoHS compatible), and free of Bromine (Br) and Antimony (Sb) based flame retardants (Br or Sb do not exceed 0.1% by weight in homogeneous material)

<sup>(3)</sup> MSL, Peak Temp. -- The Moisture Sensitivity Level rating according to the JEDEC industry standard classifications, and peak solder temperature.

**Important Information and Disclaimer:** The information provided on this page represents TI's knowledge and belief as of the date that it is provided. TI bases its knowledge and belief on information provided by third parties, and makes no representation or warranty as to the accuracy of such information. Efforts are underway to better integrate information from third parties. TI has taken and continues to take reasonable steps to provide representative and accurate information but may not have conducted destructive testing or chemical analysis on incoming materials and chemicals. TI and TI suppliers consider certain information to be proprietary, and thus CAS numbers and other limited information may not be available for release.

In no event shall TI's liability arising out of such information exceed the total purchase price of the TI part(s) at issue in this document sold by TI to Customer on an annual basis.

**TAPE AND REEL INFORMATION**
**REEL DIMENSIONS**

**TAPE DIMENSIONS**

A0	Dimension designed to accommodate the component width
B0	Dimension designed to accommodate the component length
K0	Dimension designed to accommodate the component thickness
W	Overall width of the carrier tape
P1	Pitch between successive cavity centers

**TAPE AND REEL INFORMATION**

\*All dimensions are nominal

Device	Package Type	Package Drawing	Pins	SPQ	Reel Diameter (mm)	Reel Width W1 (mm)	A0 (mm)	B0 (mm)	K0 (mm)	P1 (mm)	W (mm)	Pin1 Quadrant
TPD2E009DBZR	SOT-23	DBZ	3	3000	180.0	8.4	3.15	2.77	1.22	4.0	8.0	Q3
TPD2E009DRTR	SOT	DRT	3	3000	180.0	8.4	1.16	1.16	0.63	4.0	8.0	Q3

**TAPE AND REEL BOX DIMENSIONS**

\*All dimensions are nominal

Device	Package Type	Package Drawing	Pins	SPQ	Length (mm)	Width (mm)	Height (mm)
TPD2E009DBZR	SOT-23	DBZ	3	3000	202.0	201.0	28.0
TPD2E009DRTR	SOT	DRT	3	3000	202.0	201.0	85.0

DBZ (R-PDSO-G3)

PLASTIC SMALL-OUTLINE

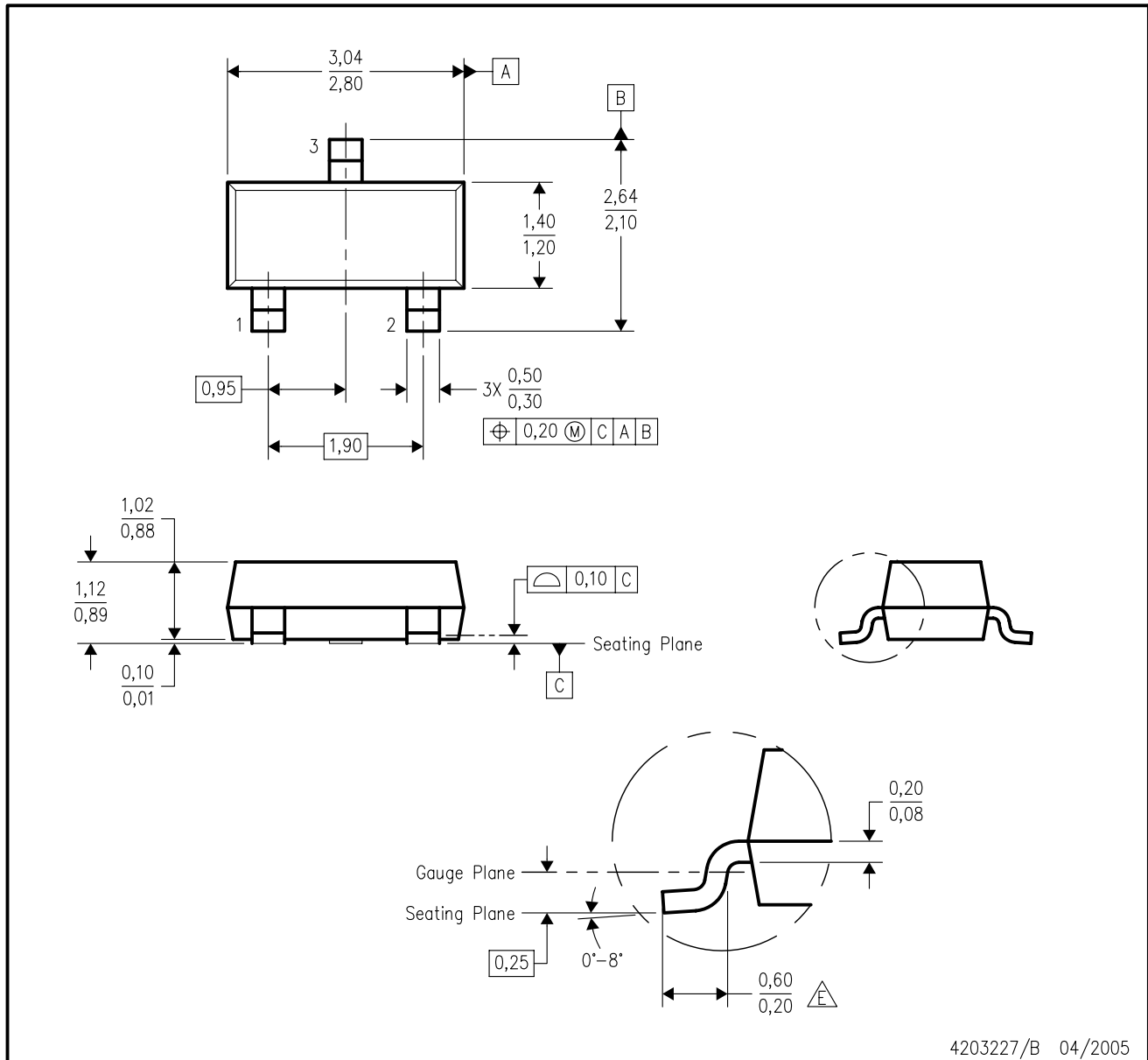

- NOTES:
- A. All linear dimensions are in millimeters. Dimensioning and tolerancing per ASME Y14.5M-1994.
  - B. This drawing is subject to change without notice.
  - C. Lead dimensions are inclusive of plating.
  - D. Body dimensions are exclusive of mold flash and protrusion. Mold flash and protrusion not to exceed 0.25 per side.
  - Falls within JEDEC TO-236 variation AB, except minimum foot length.

DBZ (R-PDSO-G3)

PLASTIC SMALL OUTLINE

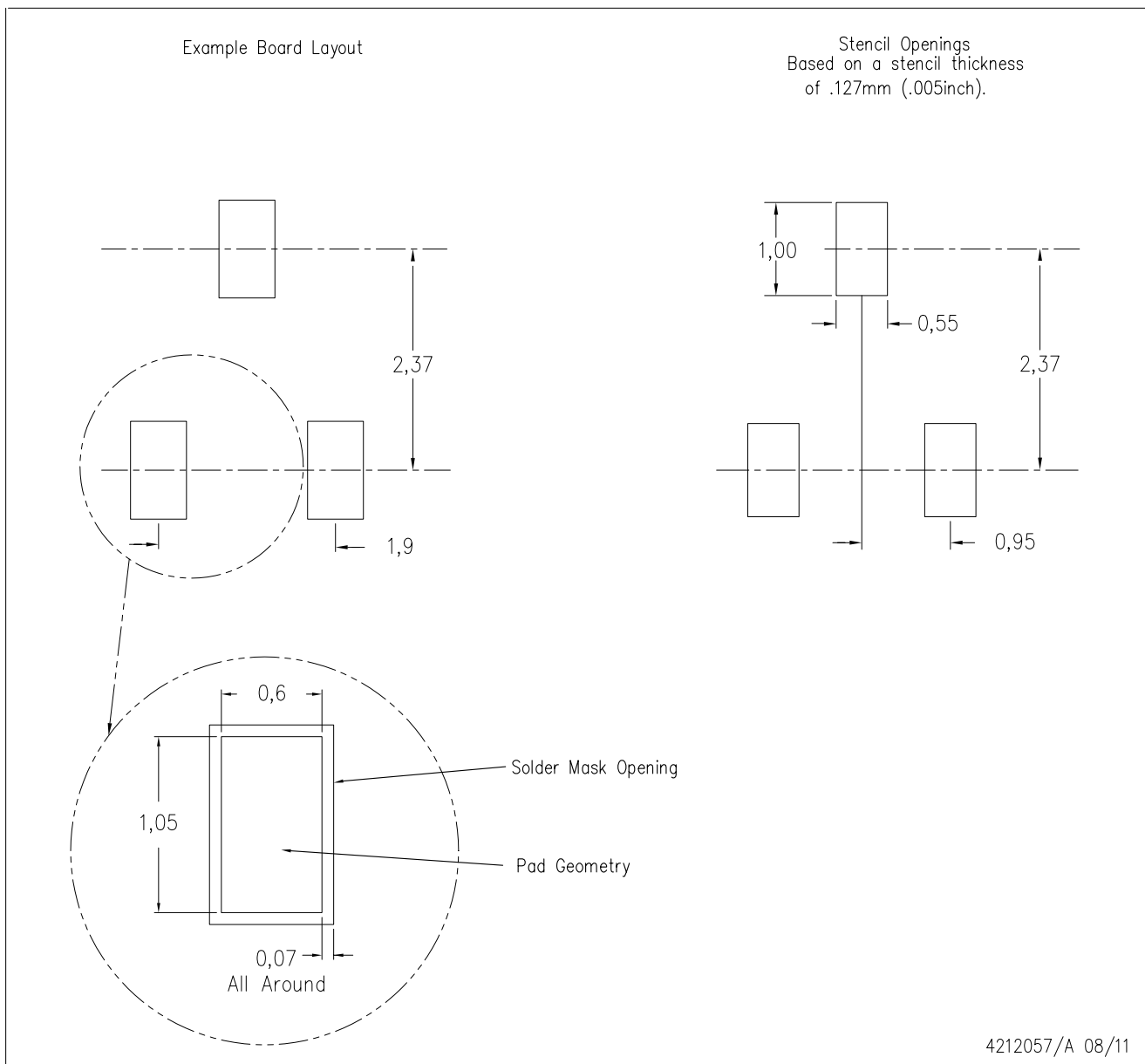

- NOTES:
- A. All linear dimensions are in millimeters.
  - B. This drawing is subject to change without notice.
  - C. Customers should place a note on the circuit board fabrication drawing not to alter the center solder mask defined pad.
  - D. Publication IPC-7351 is recommended for alternate designs.
  - E. Laser cutting apertures with trapezoidal walls and also rounding corners will offer better paste release. Customers should contact their board assembly site for stencil design recommendations. Example stencil design based on a 50% volumetric metal load solder paste. Refer to IPC-7525 for other stencil recommendations.

DRY (R-PUSON-N6)

PLASTIC SMALL OUTLINE NO-LEAD

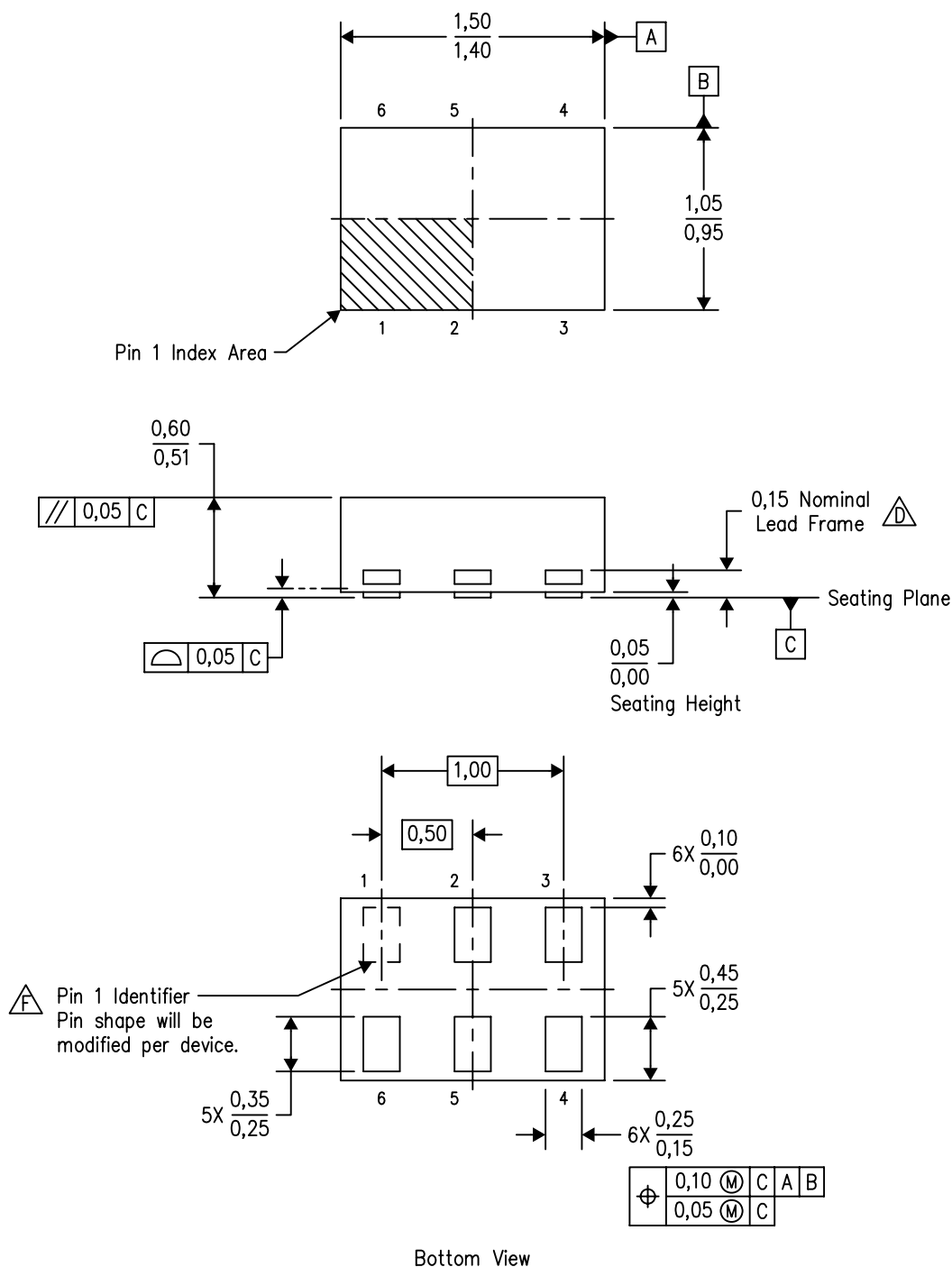

4207181/F 12/11

- NOTES:
- A. All linear dimensions are in millimeters. Dimensioning and tolerancing per ASME Y14.5M-1994.
  - B. This drawing is subject to change without notice.
  - C. SON (Small Outline No-Lead) package configuration.
  - $\triangle D$  The exposed lead frame feature on side of package may or may not be present due to alternative lead frame designs.
  - E. This package complies to JEDEC MO-287 variation UFAD.
  - $\triangle F$  See the additional figure in the Product Data Sheet for details regarding the pin 1 identifier shape.

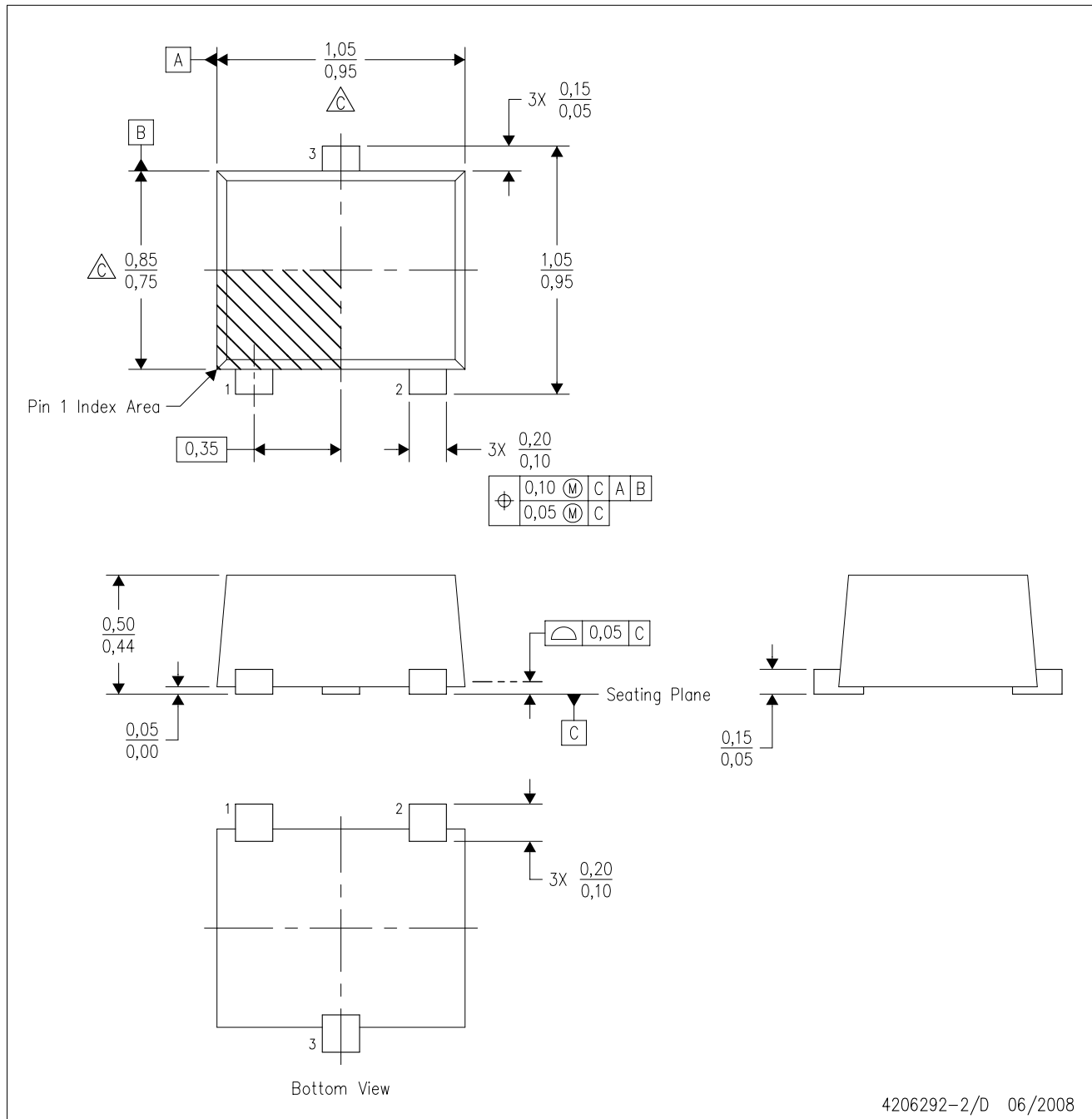

- NOTES:
- A. All linear dimensions are in millimeters. Dimensioning and tolerancing per ASME Y14.5M-1994.
  - B. This drawing is subject to change without notice.
  - C. Body dimensions do not include mold flash, interlead flash, protrusions, or gate burrs. Mold flash, interlead flash, protrusions, or gate burrs shall not exceed 0,10 per end or side.
  - D. JEDEC package registration is pending.

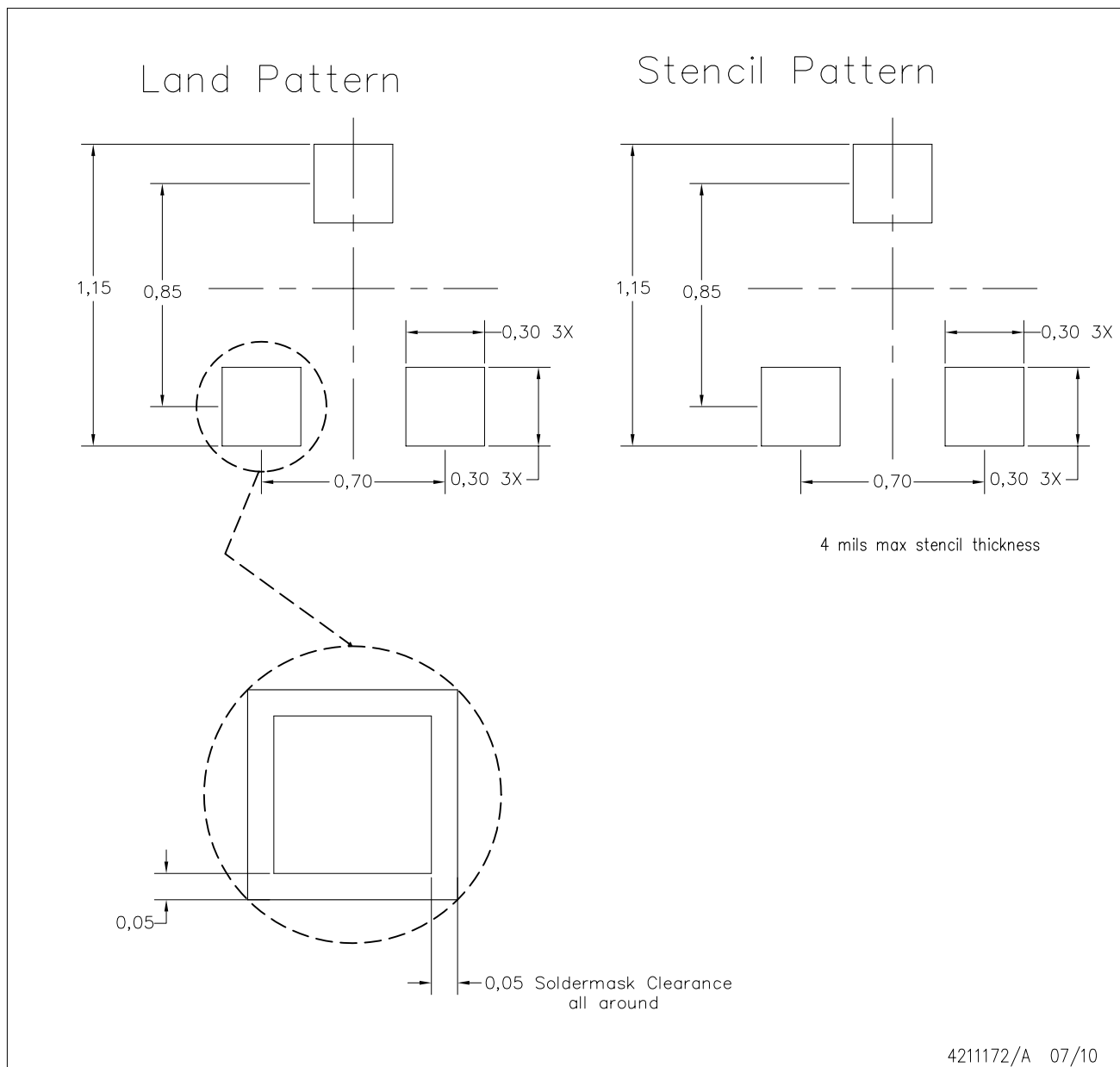

- NOTES:
- All linear dimensions are in millimeters.
  - This drawing is subject to change without notice.
  - Publication IPC-7351 is recommended for alternate designs.
  - Customers should contact their board fabrication site for minimum solder mask web tolerances between signal pads.
  - Maximum stencil thickness 0,1016 mm (4 mils). All linear dimensions are in millimeters.
  - Laser cutting apertures with trapezoidal walls and also rounding corners will offer better paste release. Customers should contact their board assembly site for stencil design recommendations. Refer to IPC 7525 for stencil design considerations.
  - Side aperture dimensions over-print land for acceptable area ratio > 0.66. Customer may reduce side aperture dimensions if stencil manufacturing process allows for sufficient release at smaller opening.



## IMPORTANT NOTICE

Texas Instruments Incorporated and its subsidiaries (TI) reserve the right to make corrections, modifications, enhancements, improvements, and other changes to its products and services at any time and to discontinue any product or service without notice. Customers should obtain the latest relevant information before placing orders and should verify that such information is current and complete. All products are sold subject to TI's terms and conditions of sale supplied at the time of order acknowledgment.

TI warrants performance of its hardware products to the specifications applicable at the time of sale in accordance with TI's standard warranty. Testing and other quality control techniques are used to the extent TI deems necessary to support this warranty. Except where mandated by government requirements, testing of all parameters of each product is not necessarily performed.

TI assumes no liability for applications assistance or customer product design. Customers are responsible for their products and applications using TI components. To minimize the risks associated with customer products and applications, customers should provide adequate design and operating safeguards.

TI does not warrant or represent that any license, either express or implied, is granted under any TI patent right, copyright, mask work right, or other TI intellectual property right relating to any combination, machine, or process in which TI products or services are used. Information published by TI regarding third-party products or services does not constitute a license from TI to use such products or services or a warranty or endorsement thereof. Use of such information may require a license from a third party under the patents or other intellectual property of the third party, or a license from TI under the patents or other intellectual property of TI.

Reproduction of TI information in TI data books or data sheets is permissible only if reproduction is without alteration and is accompanied by all associated warranties, conditions, limitations, and notices. Reproduction of this information with alteration is an unfair and deceptive business practice. TI is not responsible or liable for such altered documentation. Information of third parties may be subject to additional restrictions.

Resale of TI products or services with statements different from or beyond the parameters stated by TI for that product or service voids all express and any implied warranties for the associated TI product or service and is an unfair and deceptive business practice. TI is not responsible or liable for any such statements.

TI products are not authorized for use in safety-critical applications (such as life support) where a failure of the TI product would reasonably be expected to cause severe personal injury or death, unless officers of the parties have executed an agreement specifically governing such use. Buyers represent that they have all necessary expertise in the safety and regulatory ramifications of their applications, and acknowledge and agree that they are solely responsible for all legal, regulatory and safety-related requirements concerning their products and any use of TI products in such safety-critical applications, notwithstanding any applications-related information or support that may be provided by TI. Further, Buyers must fully indemnify TI and its representatives against any damages arising out of the use of TI products in such safety-critical applications.

TI products are neither designed nor intended for use in military/aerospace applications or environments unless the TI products are specifically designated by TI as military-grade or "enhanced plastic." Only products designated by TI as military-grade meet military specifications. Buyers acknowledge and agree that any such use of TI products which TI has not designated as military-grade is solely at the Buyer's risk, and that they are solely responsible for compliance with all legal and regulatory requirements in connection with such use.

TI products are neither designed nor intended for use in automotive applications or environments unless the specific TI products are designated by TI as compliant with ISO/TS 16949 requirements. Buyers acknowledge and agree that, if they use any non-designated products in automotive applications, TI will not be responsible for any failure to meet such requirements.

Following are URLs where you can obtain information on other Texas Instruments products and application solutions:

### Products

Audio	<a href="http://www.ti.com/audio">www.ti.com/audio</a>
Amplifiers	<a href="http://amplifier.ti.com">amplifier.ti.com</a>
Data Converters	<a href="http://dataconverter.ti.com">dataconverter.ti.com</a>
DLP® Products	<a href="http://www.dlp.com">www.dlp.com</a>
DSP	<a href="http://dsp.ti.com">dsp.ti.com</a>
Clocks and Timers	<a href="http://www.ti.com/clocks">www.ti.com/clocks</a>
Interface	<a href="http://interface.ti.com">interface.ti.com</a>
Logic	<a href="http://logic.ti.com">logic.ti.com</a>
Power Mgmt	<a href="http://power.ti.com">power.ti.com</a>
Microcontrollers	<a href="http://microcontroller.ti.com">microcontroller.ti.com</a>
RFID	<a href="http://www.ti-rfid.com">www.ti-rfid.com</a>
OMAP Mobile Processors	<a href="http://www.ti.com/omap">www.ti.com/omap</a>
Wireless Connectivity	<a href="http://www.ti.com/wirelessconnectivity">www.ti.com/wirelessconnectivity</a>

### Applications

Automotive and Transportation	<a href="http://www.ti.com/automotive">www.ti.com/automotive</a>
Communications and Telecom	<a href="http://www.ti.com/communications">www.ti.com/communications</a>
Computers and Peripherals	<a href="http://www.ti.com/computers">www.ti.com/computers</a>
Consumer Electronics	<a href="http://www.ti.com/consumer-apps">www.ti.com/consumer-apps</a>
Energy and Lighting	<a href="http://www.ti.com/energy">www.ti.com/energy</a>
Industrial	<a href="http://www.ti.com/industrial">www.ti.com/industrial</a>
Medical	<a href="http://www.ti.com/medical">www.ti.com/medical</a>
Security	<a href="http://www.ti.com/security">www.ti.com/security</a>
Space, Avionics and Defense	<a href="http://www.ti.com/space-avionics-defense">www.ti.com/space-avionics-defense</a>
Video and Imaging	<a href="http://www.ti.com/video">www.ti.com/video</a>

TI E2E Community Home Page

[e2e.ti.com](http://e2e.ti.com)

Mailing Address: Texas Instruments, Post Office Box 655303, Dallas, Texas 75265  
Copyright © 2012, Texas Instruments Incorporated

# Mouser Electronics

Authorized Distributor

Click to View Pricing, Inventory, Delivery & Lifecycle Information:

[Texas Instruments:](#)

[TPD2E009DBZR](#) [TPD2E009DRTR](#)