

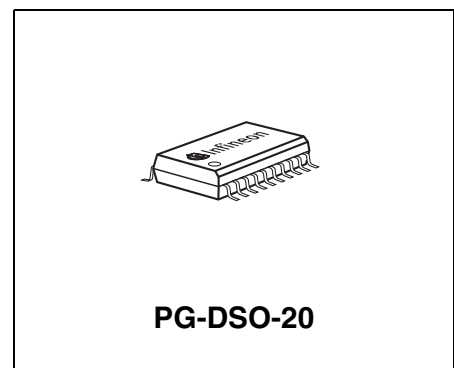

## Features

- Stand-by output 180 mA; 5 V ± 2%
- Adjustable reset switching threshold
- Main output 350 mA; tracked to the stand-by output
- Low quiescent current consumption in standby mode
- Disable function for main output
- Wide operation range: up to 45 V
- Very low dropout
- Power-On-Reset circuit sensing the stand-by voltage
- Early warning comparator for supply undervoltage
- Output protected against short circuit
- Wide temperature range: -40 °C to 150 °C
- Overtemperature protection
- Overload protection
- Green Product (RoHS compliant)
- AEC Qualified

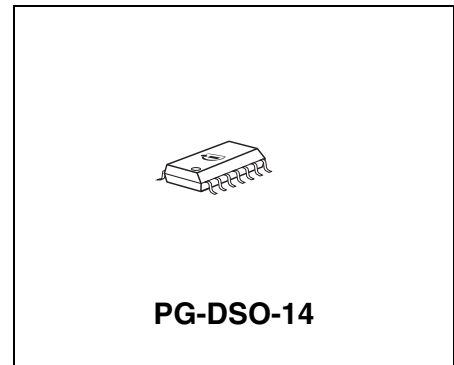

## Functional Description

The TLE 4470 is a monolithic integrated voltage regulator with two very low-drop outputs, a main output Q2 for loads up to 350 mA and a stand by output Q1 providing a maximum of 180 mA. The device is available in two packages the PG-DSO-14 and PG-DSO-20. It is designed to supply microprocessor systems under the severe conditions of automotive applications and is therefore equipped with additional protection functions against overload, short circuit and overtemperature. Of course the TLE 4470 can also be used in other applications where two stabilized voltages are required.

The device operates in the wide junction temperature range of -40 °C to 150 °C.

The stand-by regulator transforms an input voltage  $V_I$  in the range of  $5.6 \text{ V} \leq V_I \leq 45 \text{ V}$  to  $V_{Q1, \text{nom}} = 5 \text{ V}$  within an accuracy of 2%, whereas the main regulator is adjustable. By

Type	Package
TLE 4470 GS	PG-DSO-14
TLE 4470 G	PG-DSO-20

use of an external voltage divider the main output voltage can be set to  $V_{Q2} \geq 5\text{ V}$  for the TLE 4470 G type (PG-DSO-20 package).  $V_{Q1}$  is compared to the voltage at pin ADJ2, which is proportional to the output voltage  $V_{Q2}$ . A control amplifier drives the base of the series PNP transistor via a buffer.

The main output voltage  $V_{Q2}$  is tracked to the accuracy of the stand-by output.

For the TLE 4470 GS (PG-DSO-14 package) the output voltage is fixed to 5 V.

To save energy e.g. in battery powered body electronic applications, the main regulator can be switched off via the disable input, which causes the current consumption to drop to 180  $\mu\text{A}$  typical.

Two additional features of the TLE 4470 are an early warning comparator (can be used e.g. to monitor the supply voltage  $V_I$ ) and reset generator with an adjustable reset delay time. The TLE 4470 G (PG-DSO-20 package) has in addition an adjustable reset switching threshold. This feature is useful with microprocessors which guarantee a safe operation down to voltages below the internally set reset threshold of 4.65 V typical.

Two functions are included in the reset generator, a power-on-reset and an under-voltage reset. The power-on-reset feature is necessary for a defined start of the microprocessor when switching on the application. The reset signal is kept low for a certain delay time after the output voltage  $V_{Q1}$  of the regulator has surpassed the reset threshold. An external delay capacitor sets this delay time. The under voltage reset circuit supervises the stand-by output voltage. In case  $V_{Q1}$  falls below the reset switching threshold the reset output is set LOW after a short reaction time. The reset LOW signal is generated down to an output voltage  $V_{Q1}$  of 1 V.

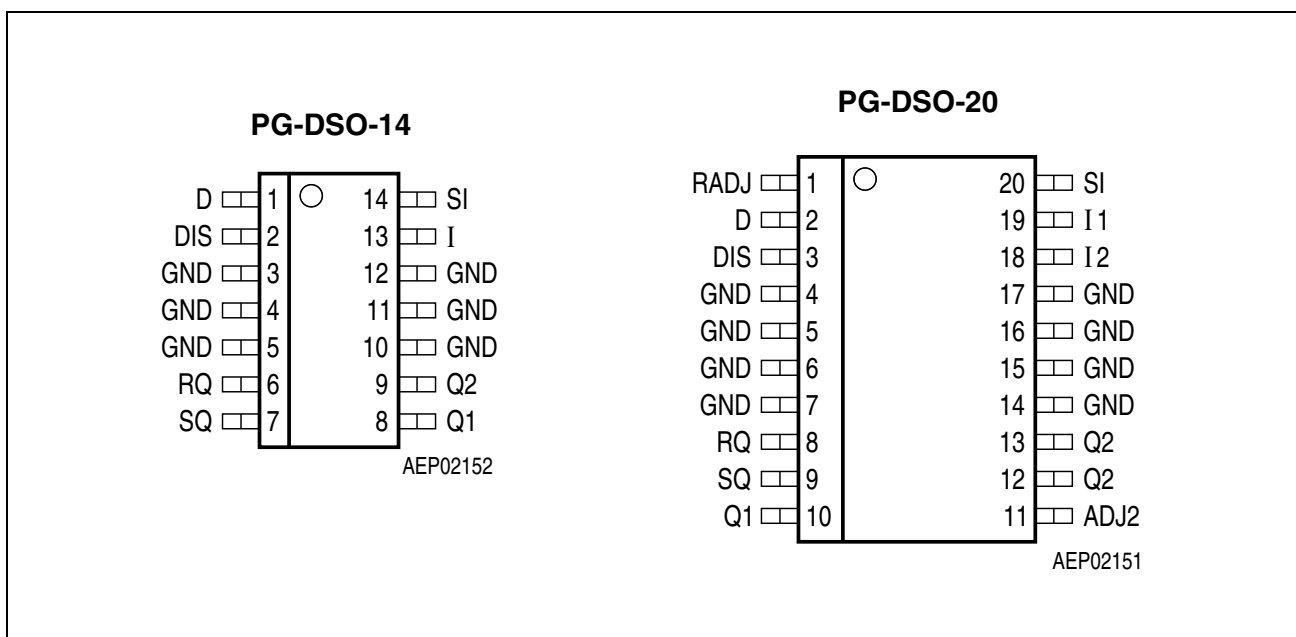

**Figure 1 Pin Configuration (top view)**

Pin Definitions and Functions

Table 1 PG-DSO-20

Pin No.	Symbol	Function
1	RADJ	<b>Reset switching threshold adjust;</b> for setting the reset switching threshold connect to a voltage divider from Q1 to GND. If this input is connected to GND, the reset is triggered at the internal threshold.
2	D	<b>Reset delay;</b> connect a capacitor $C_D$ to GND for delay time adjustment
3	DIS	<b>Disable input main regulator;</b> Q2 disabled with high signal
4, 5, 6, 7	GND	<b>Ground</b>
8	RQ	<b>Reset output;</b> the open collector output is connected to Q1 via an integrated 30 k $\Omega$ resistor
9	SQ	<b>Sense output;</b> the open collector output is connected to Q1 via an integrated 30 k $\Omega$ resistor
10	Q1	<b>Stand-by regulator output voltage;</b> block to GND with a capacitor $C_{Q1} \geq 6 \mu\text{F}$ , ESR < 10 $\Omega$ at 10 kHz
11	ADJ2	<b>Main regulator adjust input;</b> Q2 can be set to higher values than 5 V by an external voltage divider from Q2 to GND
12, 13	Q2	<b>Main regulator output voltage;</b> block to GND with a capacitor $C_{Q2} \geq 10 \mu\text{F}$ , ESR < 10 $\Omega$ at 10 kHz
14, 15, 16, 17	GND	<b>Ground</b>
18	I2	<b>Main regulator input voltage;</b> block to GND directly at the IC with a ceramic capacitor
19	I1	<b>Stand-by regulator input voltage;</b> block to GND directly at the IC with a ceramic capacitor
20	SI	<b>Sense comparator input</b>

**Table 2 PG-DSO-14**

Pin No.	Symbol	Function
1	D	<b>Reset delay</b> ; connect a capacitor $C_D$ to GND for delay time adjustment
2	DIS	<b>Disable input main regulator</b> ; Q2 disabled with high signal
3, 4, 5	GND	<b>Ground</b>
6	RQ	<b>Reset output</b> ; the open collector output is connected to Q1 via an integrated 30 k $\Omega$ resistor
7	SQ	<b>Sense output</b> ; the open collector output is connected to Q1 via an integrated 30 k $\Omega$ resistor
8	Q1	<b>Stand-by regulator output voltage</b> ; block to GND with a capacitor, $C_{Q1} \geq 6 \mu\text{F}$ , ESR < 10 $\Omega$ at 10 kHz
9	Q2	<b>Main regulator output voltage</b> ; 5 V output tracking to Q1, block to GND with a capacitor $C_{Q2} \geq 10 \mu\text{F}$ , ESR < 10 $\Omega$ at 10 kHz
10, 11, 12	GND	<b>Ground</b>
13	I	<b>Main and stand-by regulator input voltage</b> ; block to GND directly at the IC with a ceramic capacitor
14	SI	<b>Sense comparator input</b>

RADJ: Adjustable reset switching threshold is not available in the PG-DSO-14 package. Reset is always triggered at the internal threshold.

ADJ2: Main regulator adjust input is internally connected to  $V_{Q2}$ .

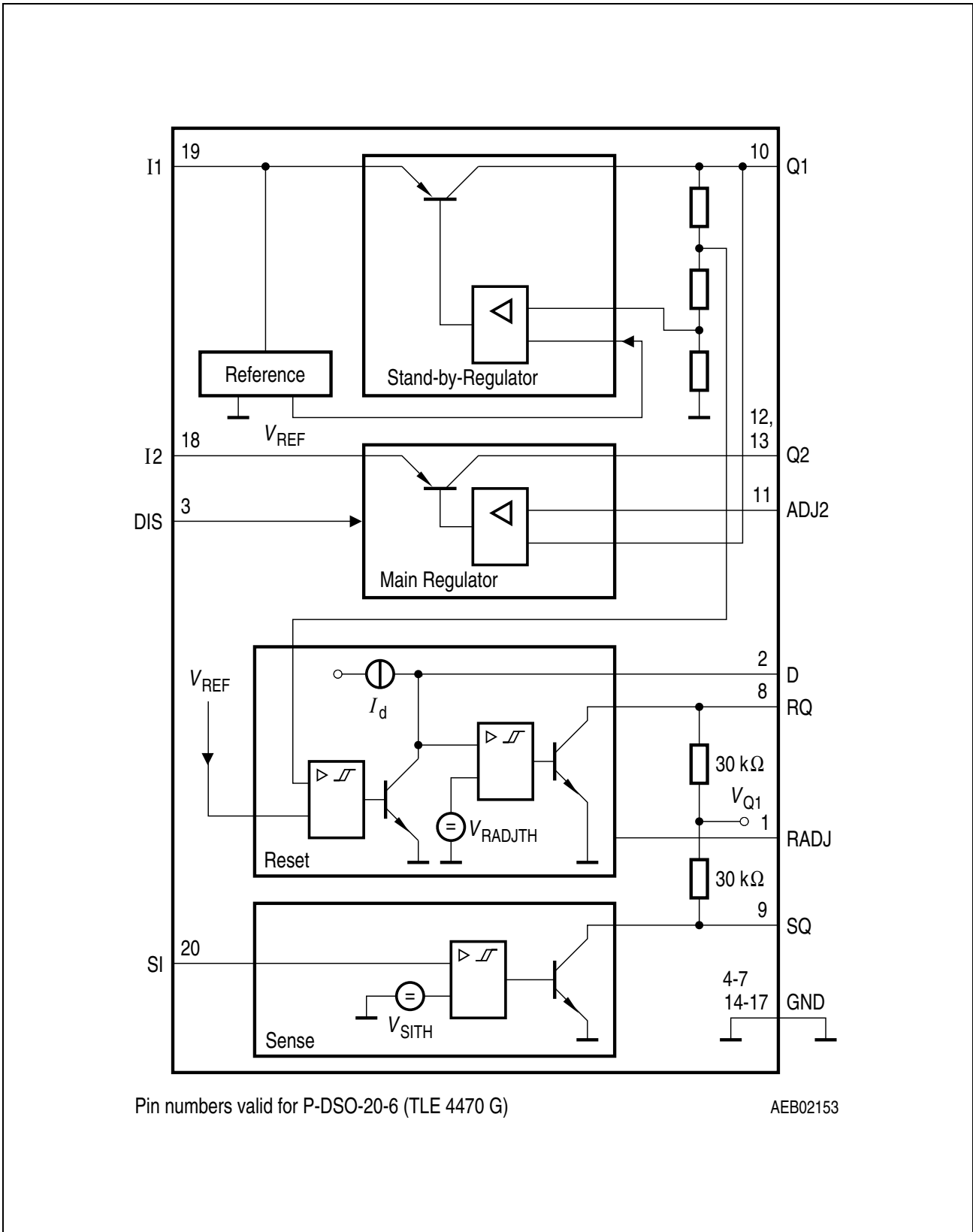

**Figure 2** Block Diagram

**Table 3 Absolute Maximum Ratings**
 $-40\text{ °C} < T_j < 150\text{ °C}$ 

Parameter	Symbol	Limit Values		Unit	Remarks
		Min.	Max.		
<b>Stand-by Regulator Input I1</b>					
Voltage	$V_{I1}$	-42	45	V	–
Current	$I_{I1}$	–	–	mA	Internally limited
<b>Main Regulator Input I2</b>					
Voltage	$V_{I2}$	-42	45	V	–
Current	$I_{I2}$	–	–	mA	Internally limited
<b>Stand-by Output Q1</b>					
Voltage	$V_{Q1}$	-1	7	V	–
Current	$I_{Q1}$	–	–	mA	Internally limited
<b>Main Output Q2</b>					
Voltage	$V_{Q2}$	-1	36	V	–
Current	$I_{Q2}$	–	–	mA	Internally limited
<b>Main Regulator Adjust Input ADJ2</b>					
Voltage	$V_{ADJ2}$	-0.3	18	V	–
Current	$I_{ADJ2}$	–	–	mA	Internally limited
<b>Sense Output SQ</b>					
Voltage	$V_{SQ}$	-0.3	25	V	–
Current	$I_{SQ}$	-5	5	mA	–
<b>Reset Output RQ</b>					
Voltage	$V_{RQ}$	-0.3	25	V	–
Current	$I_{RQ}$	-5	5	mA	–
<b>Disable Input DIS</b>					
Voltage	$V_{DIS}$	-42	45	V	–
Current	$I_{DIS}$	-2	2	mA	–
<b>Sense Input SI</b>					
Voltage	$V_{SI}$	-25	18	V	–
Current	$I_{SI}$	-2	2	mA	–

**Table 3 Absolute Maximum Ratings (cont'd)**

$-40\text{ °C} < T_j < 150\text{ °C}$

Parameter	Symbol	Limit Values		Unit	Remarks
		Min.	Max.		
<b>Reset Delay D</b>					
Voltage	$V_D$	-0.3	7	V	–
Current	$I_D$	-2	2	mA	–
<b>Reset Switching Threshold Adjust RADJ</b>					
Voltage	$V_{RADJ}$	-0.3	7	V	–
Current	$I_{RADJ}$	–	–	mA	Internally limited
<b>Temperatures</b>					
Junction temperature	$T_j$	-50	150	°C	–
Storage temperature	$T_{stg}$	-50	150	°C	–

*Note: ESD-Protection according to MIL Std. 883: ±2 kV.*

*Maximum ratings are absolute ratings; exceeding any one of these values may cause irreversible damage to the integrated circuit.*

**Table 4 Operating Range**

Parameter	Symbol	Limit Values		Unit	Remarks
		Min.	Max.		
Stand-by regulator input voltage	$V_{I1}$	5.6	45	V	–
Main regulator input voltage	$V_{I2}$	$V_{Q2,nom} + 0.6\text{ V}$	45	V	–
Stand-by regulator output current	$I_{Q1}$	0	180	mA	–
Main regulator output current	$I_{Q2}$	0	350	mA	–
Disable input voltage	$V_{DIS}$	-0.3	45	V	–
Sense input voltage	$V_{SI}$	-0.3	17	V	–
Junction temperature	$T_j$	-40	150	°C	–

**Thermal Resistances PG-DSO-14**

Junction pin	$R_{thj-pin}$	–	32	K/W	Measured to pin 4
Junction ambient	$R_{thj-a}$	–	112	K/W	<sup>1)</sup>

**Thermal Resistances PG-DSO-20**

Junction pin	$R_{thj-pin}$	–	23	K/W	Measured to pin 4
Junction ambient	$R_{thj-a}$	–	100	K/W	<sup>1)</sup>

1) Package mounted on PCB  $80 \times 80 \times 1.5\text{ mm}^3$ ;  $35\text{ }\mu\text{ Cu}$ ;  $5\text{ }\mu\text{ Sn}$ ; Footprint only; zero airflow.

*Note: In the operating range the functions given in the circuit description are fulfilled.*



**Table 5 Electrical Characteristics**
 $V_{I1} = V_{I2} = 14 \text{ V}; V_{DIS} < V_{DISL}; -40 \text{ }^\circ\text{C} < T_j < 150 \text{ }^\circ\text{C};$  unless otherwise specified

Parameter	Symbol	Limit Values			Unit	Test Condition
		Min.	Typ.	Max.		
<b>Stand-by Regulator</b>						
<b>Output 1</b>						
Output voltage	$V_{Q1}$	4.90	5.0	5.10	V	$1 \text{ mA} < I_{Q1} < 100 \text{ mA}$
Output current limitation	$I_{Q1}$	180	280	–	mA	<sup>1)</sup>
Output drop voltage; $V_{DRQ1} = V_{I1} - V_{Q1}$	$V_{DRQ1}$	–	300	500	mV	$I_{Q1} = 100 \text{ mA}^{1)}$
<b>Current Consumption</b>						
Quiescent current; stand-by $I_q = I_{I1} - I_{Q1}$	$I_q$	–	180	250	$\mu\text{A}$	$I_{Q1} = 300 \mu\text{A}; T_j = 25 \text{ }^\circ\text{C}$ $V_{DIS} > V_{DISH} \text{ (Q2 = OFF)}$
		–	180	300	$\mu\text{A}$	$I_{Q1} = 300 \mu\text{A};$ $V_{DIS} > V_{DISH} \text{ (Q2 = OFF)}$
Quiescent current $I_q = I_{I1} - I_{Q1}$	$I_q$	–	4	6	mA	$I_{Q1} = 100 \text{ mA};$ $V_{DIS} > V_{DISH} \text{ (Q2 = OFF)}$
<b>Regulator Performance</b>						
Load regulation	$\Delta V_{Q1,Lo}$	–	15	50	mV	$1 \text{ mA} < I_{Q1} < 150 \text{ mA}$
Load regulation	$\Delta V_{Q1,Lo}$	–	5	25	mV	$1 \text{ mA} < I_{Q1} < 100 \text{ mA}$
Line regulation	$\Delta V_{Q1,Li}$	–	5	20	mV	$I_{Q1} = 1 \text{ mA};$ $6 \text{ V} < V_{I1} < 28 \text{ V}$
Power Supply Ripple Rejection	$PSRR$	–	60	–	dB	$20 \text{ Hz} < f_r < 20 \text{ kHz};$ $V_r = 5 \text{ Vpp}$
Temperature output voltage drift	$\Delta V_{Q1}/\Delta T$	–	0.3	–	mV/ K	–
$dV_{I1}/dt$ stability	$V_{Q1}$	4.5	–	5.5	V	no reset occurs <sup>2)</sup>
Value of output capacitance	$C_{Q1}$	6	–	–	$\mu\text{F}$	–
ESR of output capacitance	$ESR_{CQ1}$	–	–	10	$\Omega$	at 10 kHz

**Table 5 Electrical Characteristics (cont'd)**
 $V_{I1} = V_{I2} = 14 \text{ V}; V_{DIS} < V_{DISL}; -40 \text{ }^\circ\text{C} < T_j < 150 \text{ }^\circ\text{C};$  unless otherwise specified

Parameter	Symbol	Limit Values			Unit	Test Condition
		Min.	Typ.	Max.		
<b>Main-Regulator</b>						
<b>Output 2</b>						
Output voltage tracking accuracy	$\Delta V_{Q2} = V_{Q2} - V_{Q1}$	-25	5	25	mV	$5 \text{ mA} < I_{Q2} < 100 \text{ mA};$ $6 \text{ V} < V_{I2} < 40 \text{ V}^{(3)}$
Output voltage tracking accuracy	$\Delta V_{Q2} = V_{Q2} - V_{Q1}$	-25	5	25	mV	$5 \text{ mA} < I_{Q2} < 250 \text{ mA};$ $7 \text{ V} < V_{I2} < 28 \text{ V}^{(3)}$
Adjust input current	$I_{ADJ2}$	-1	–	1	$\mu\text{A}$	–
Output current limitation	$I_{Q2}$	350	500	–	mA	<sup>1)</sup>
Output drop voltage $V_{DRQ2} = V_{I2} - V_{Q2}$	$V_{DRQ2}$	–	300	600	mV	$I_{Q2} = 200 \text{ mA}^{(1)}$
<b>Current Consumption</b>						
Quiescent current; $I_q = I_I - I_Q$	$I_q$	–	7	15	mA	$I_{Q2} = 200 \text{ mA};$ $I_{Q1} = 300 \mu\text{A}$
Quiescent current; $I_q = I_I - I_Q$	$I_q$	–	250	500	$\mu\text{A}$	$I_{Q2} = I_{Q1} = 300 \mu\text{A};$ $T_j = 25 \text{ }^\circ\text{C}$
<b>Regulator Performance</b>						
Load regulation	$\Delta V_{Q2,Lo}$	–	5	25	mV	$5 \text{ mA} < I_{Q2} < 200 \text{ mA};$
Line regulation	$\Delta V_{Q2,Li}$	–	5	20	mV	$I_{Q2} = 5 \text{ mA};$ $6 \text{ V} < V_{I2} < 28 \text{ V}$
Power Supply Ripple Rejection	$PSRR$	–	60	–	dB	$20 \text{ Hz} < f_r < 20 \text{ kHz};$ $V_r = 5 \text{ Vpp}$
Temperature output voltage drift	$\Delta V_{Q2}/\Delta T$	–	0.5	–	mV/ K	–
$dV_{I2}/dt$ stability	$V_{Q2}$	4.5	–	5.5	V	no reset occurs <sup>3)</sup>
Value of output capacitance	$C_{Q2}$	10	–	–	$\mu\text{F}$	–
ESR of output capacitance	$ESR_{CQ2}$	–	–	10	$\Omega$	at 10 kHz

**Table 5 Electrical Characteristics (cont'd)**
 $V_{I1} = V_{I2} = 14 \text{ V}; V_{DIS} < V_{DISL}; -40 \text{ }^\circ\text{C} < T_j < 150 \text{ }^\circ\text{C};$  unless otherwise specified

Parameter	Symbol	Limit Values			Unit	Test Condition
		Min.	Typ.	Max.		
<b>Disable Input DIS</b>						
H-input voltage threshold	$V_{DISH}$	2.3	–	–	V	–
L-input voltage threshold	$V_{DISL}$	–	–	1.4	V	Output 2 active
H-input current	$I_{DISH}$	-2	-1	1	$\mu\text{A}$	$2.3 \text{ V} < V_{DIS} < 7 \text{ V}$
L-input current	$I_{DISL}$	-6	-2	-0.5	$\mu\text{A}$	$0 \text{ V} < V_{DIS} < 1.4 \text{ V}$
<b>Reset Timing D and Output RQ</b>						
Reset switching threshold	$V_{Q,rt}$	4.5	4.65	4.8	V	RADJ connected to GND
Reset adjust threshold	$V_{RADJTH}$	1.25	1.35	1.45	V	$V_{Q1} > 3.5 \text{ V}$
Reset output low voltage	$V_{RQL}$	–	0.15	0.3	V	$R_{RQ} = 10 \text{ k}\Omega$ externally connected to Q1; $V_{Q1} \geq 1 \text{ V}$
Reset high voltage	$V_{RQH}$	4.5	–	–	V	–
Reset pull-up resistor	$R_{RQ}$	20	30	45	$\text{k}\Omega$	Internally connected to Q1
Reset charging current	$I_{D,c}$	3	5	9	$\mu\text{A}$	$V_D = 1 \text{ V}$
Upper timing threshold	$V_{DU}$	1.5	1.8	2.2	V	–
Lower timing threshold	$V_{DL}$	0.3	0.4	0.55	V	–
Reset delay time	$t_{rd}$	12	15	20	ms	$C_D = 47 \text{ nF}$
Reset reaction time	$t_{rr}$	–	0.5	2.0	$\mu\text{s}$	$C_D = 47 \text{ nF}$

**Table 5 Electrical Characteristics (cont'd)**
 $V_{I1} = V_{I2} = 14 \text{ V}; V_{DIS} < V_{DISL}; -40 \text{ }^\circ\text{C} < T_j < 150 \text{ }^\circ\text{C};$  unless otherwise specified

Parameter	Symbol	Limit Values			Unit	Test Condition
		Min.	Typ.	Max.		
<b>Sense Input SI and Output SQ</b>						
Sense threshold voltage	$V_{SITH}$	1.28	1.35	1.45	V	$V_{SI}$ decreasing
Sense threshold hysteresis	$V_{SIHY}$	25	60	100	mV	–
Sense output low voltage	$V_{SQL}$	–	0.15	0.4	V	$R_{SQ} = 10 \text{ k}\Omega$ externally connected to Q1; $V_{SI} < 1.1 \text{ V}; V_{I1} > 4.5 \text{ V}$
Sense output high voltage	$V_{SQH}$	4.5	–	–	V	–
Sense pull-up resistor	$R_{SQ}$	20	30	45	k $\Omega$	Internally connected to Q1

1) Measured when the output voltage  $V_Q$  has dropped 100 mV from the nominal value.

2) Square wave at  $V_i$ : 8 V to 18 V;  $f = 10 \text{ kHz}; t_r = t_f \leq 100 \text{ ns}$ .

3)  $V_{Q2}$  connected to ADJ2.

Application Information

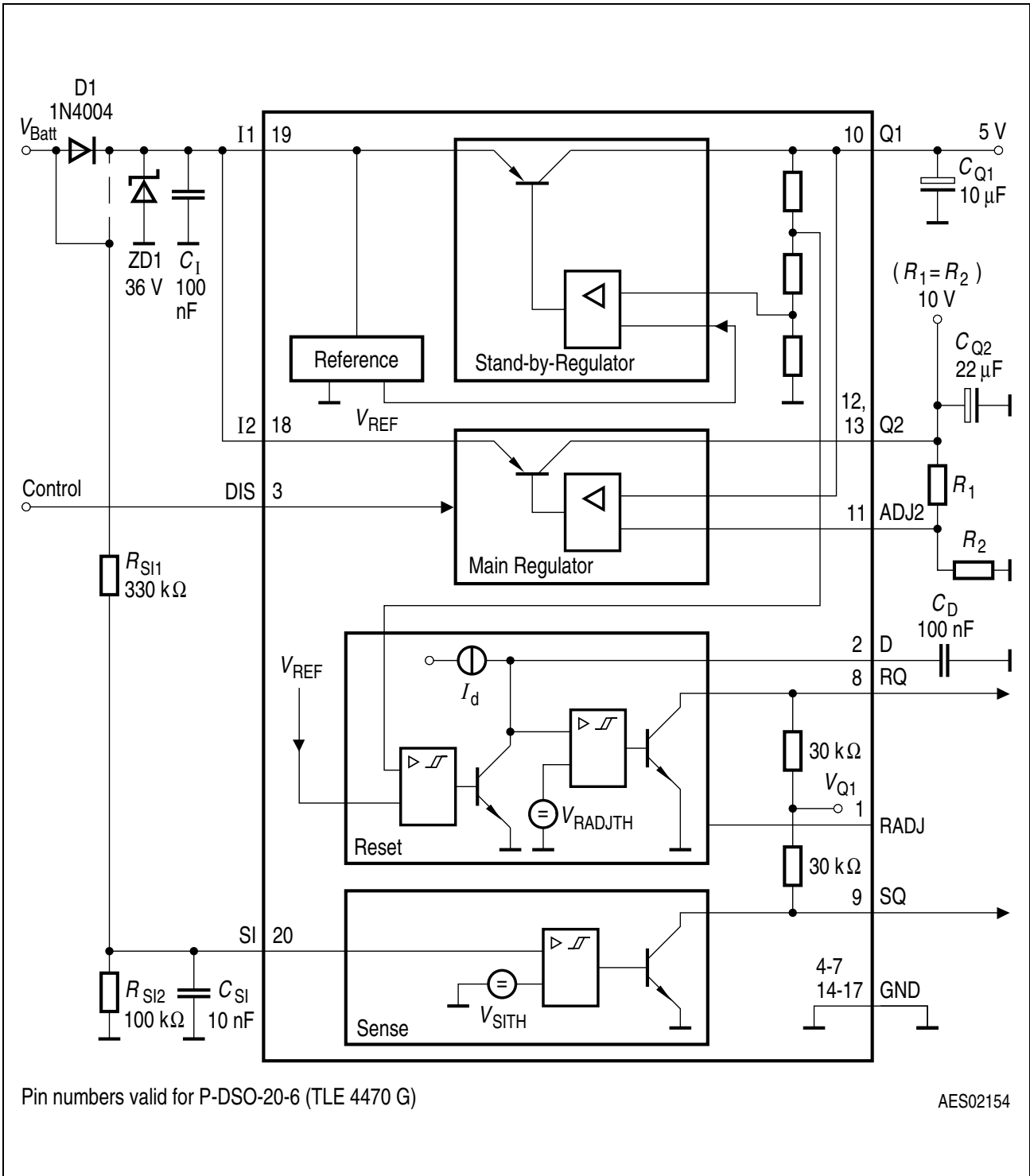

Figure 3 Application Circuit

## Input, Output

The input capacitor  $C_1$  is necessary for compensating line influences. Using a resistor of approx.  $1 \Omega$  in series with  $C_1$ , the LC circuit of input inductivity and input capacitance can be damped. To stabilize the regulation circuits of the stand-by and main regulator, output capacitors  $C_{Q1}$  and  $C_{Q2}$  are necessary. Stability is guaranteed at values  $C_{Q1} \geq 6 \mu\text{F}$  and  $C_{Q2} \geq 10 \mu\text{F}$ , both with an ESR  $\leq 10 \Omega$  within the operating temperature range.

For the TLE 4470 G (PG-DSO-20) the output voltage  $V_{Q2}$  of the main regulator can be adjusted to  $5 \text{ V} \leq V_{Q2, \text{nom}} \leq 20 \text{ V}$  by connecting an external voltage divider to the voltage adjust pin ADJ2. For  $V_{Q2} = 5 \text{ V}$  the voltage adjust pin has to be connected directly to the main output.

For calculating  $V_{Q2}$  or  $R_1$  and  $R_2$  respectively the following equations can be used:

$$V_{Q2} = V_{Q1} \times (1 + R_1 / R_2) \quad (1)$$

or

$$R_1 = R_2 \times (V_{Q2} / V_{Q1} - 1) \quad (2)$$

## Disable

The main regulator of the TLE 4470 can be switched OFF by a voltage above 2.3 V at pin DIS. Reducing this voltage below 1.4 V will switch ON the main regulator again.

## Reset Timing

The power-on reset delay time is defined by the charging time of an external capacitor  $C_D$  which can be calculated as follows:

$$C_D = (\Delta t \times I_{D,c}) / \Delta V \quad (3)$$

Definitions:

- $C_D$  = delay capacitor
- $\Delta t$  = reset delay time
- $I_{D,c}$  = charge current, typical 5  $\mu\text{A}$
- $\Delta V = V_{DU}$ , typical 1.8 V
- $V_{DU}$  = upper delay switching threshold at  $C_D$  for reset delay time

The reset reaction time  $t_{rr}$  is the time it takes the voltage regulator to set the reset out LOW after the output voltage has dropped below the reset threshold. It is typically 2  $\mu\text{s}$  for delay capacitor of 100 nF. For other values for  $C_D$  the reaction time can be estimated using the following equation:

$$t_{rr} \approx 20 \text{ s/F} \times C_D \quad (4)$$

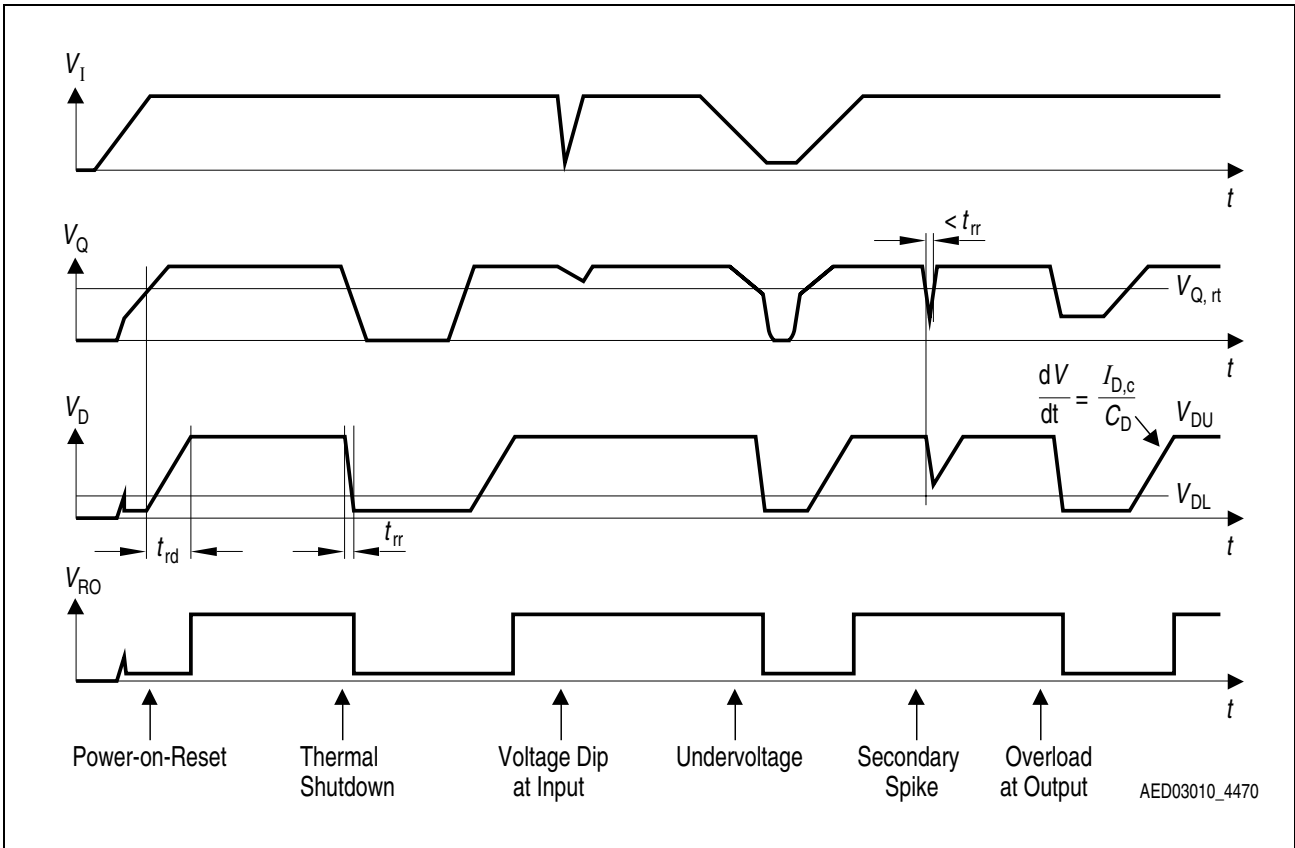

**Figure 4 Reset Timing**

### Reset Switching Threshold

The internally set reset threshold is 4.65 V. When using the TLE 4470 G (PG-DSO-20) this threshold can be adjusted to  $3.5 \text{ V} < V_{Q,rt} < 4.6 \text{ V}$  by connecting an external voltage divider to pin RADJ. If this pin is not needed, it can be left open or even better connected to GND.

$$R_1 = R_2 \times (V_{Q,rt} - V_{ref}) / V_{ref} \text{ or } V_{Q,rt} = V_{ref} (1 + R_1 / R_2) \quad (5)$$

Definitions:

- $V_{Q,rt}$  = Reset threshold
- $V_{ref}$  = comparator reference voltage, typical 1.35 V (Reset adjust input current  $\approx 50 \text{ nA}$ )

The reset output pin is internally connected to the stand-by output Q1 via a 30 k $\Omega$  pull-up resistor. The reset LOW signal at pin RQ is guaranteed down to an output voltage  $V_{Q1}$  of 1 V typical.

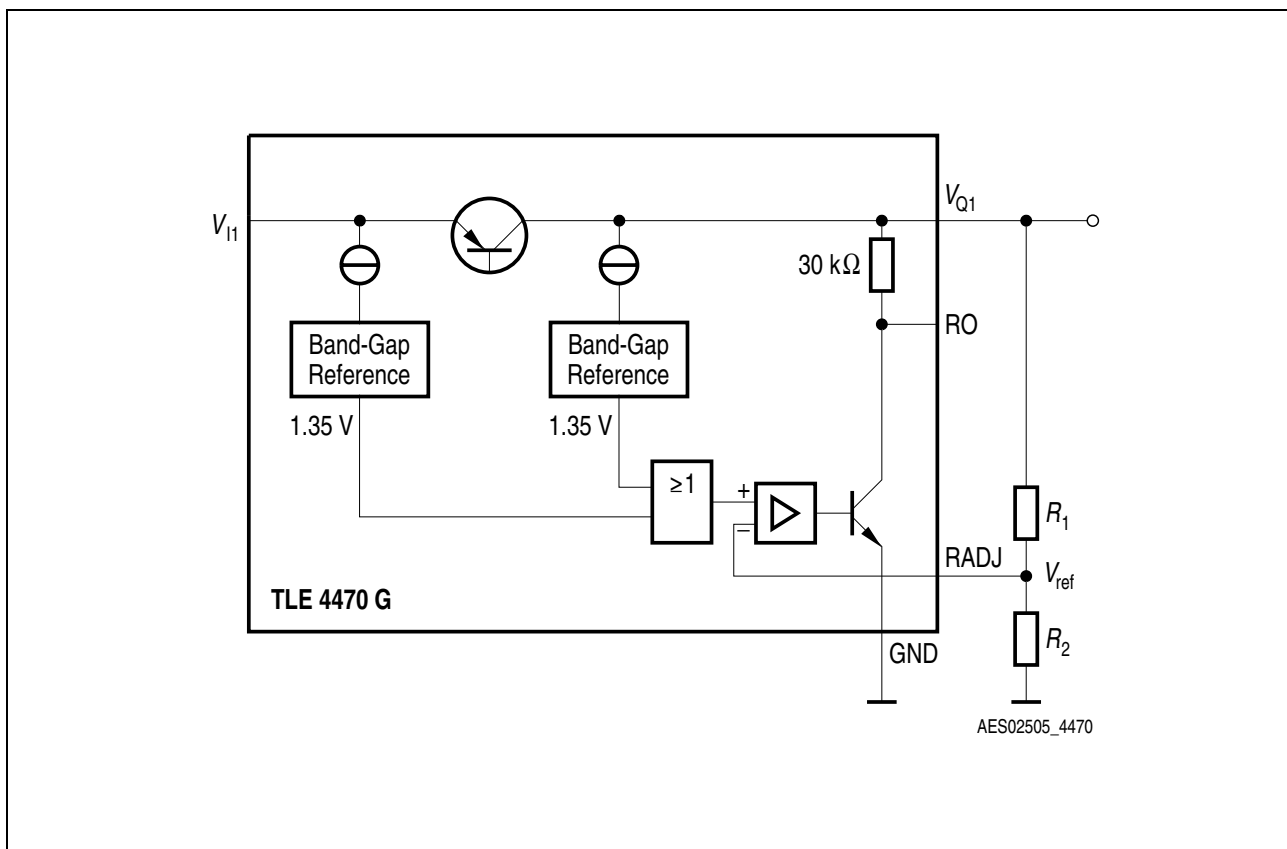

Figure 5

### Early Warning

The early warning function compares a voltage defined by the user to an internal reference voltage. Therefore the voltage to be supervised has to be scaled down by an external voltage divider in order to compare it to internal sense threshold (reference voltage) which is typically 1.35 V. The sense out pin is set to low when the user defined voltage falls below this threshold.

A typical example where this circuit can be used is to supervise the input voltage  $V_I$  to give the microprocessor a prewarning of a low battery condition.

Calculation of the voltage divider can be easily done since the sense input current can be neglected. The equations needed for calculation are identical to the previously given ones.

To minimize transient influences the use of a capacitor in parallel to  $R_2$  is recommended.

Like the reset output pin, the sense out pin SQ is internally connected to the stand-by output Q1 via a 30 kΩ pull-up resistor. The sense out LOW signal at pin SQ is generated down to an input voltage  $V_{I1}$  of 3 V typical.



Typical Performance Characteristics

Drop Voltage  $V_{DRQ1}$  versus Output Current  $I_{Q1}$

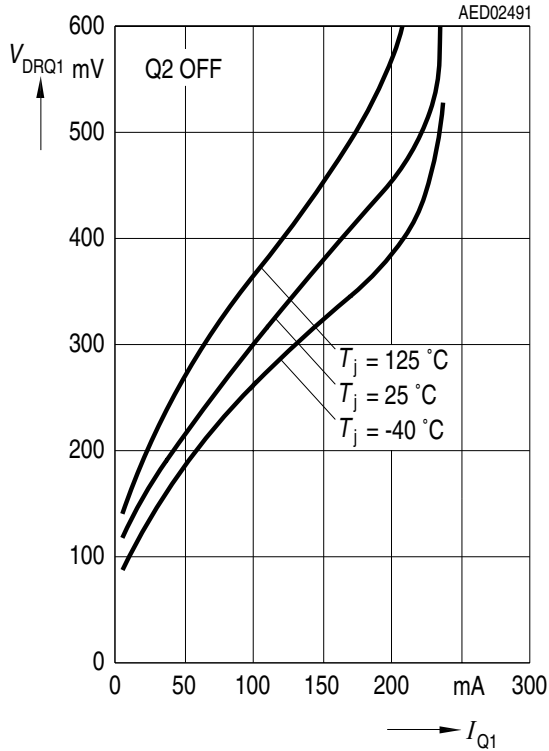

Output Voltage  $V_{Q1}, V_{Q2}$  versus Output Current  $I_{Q1}$

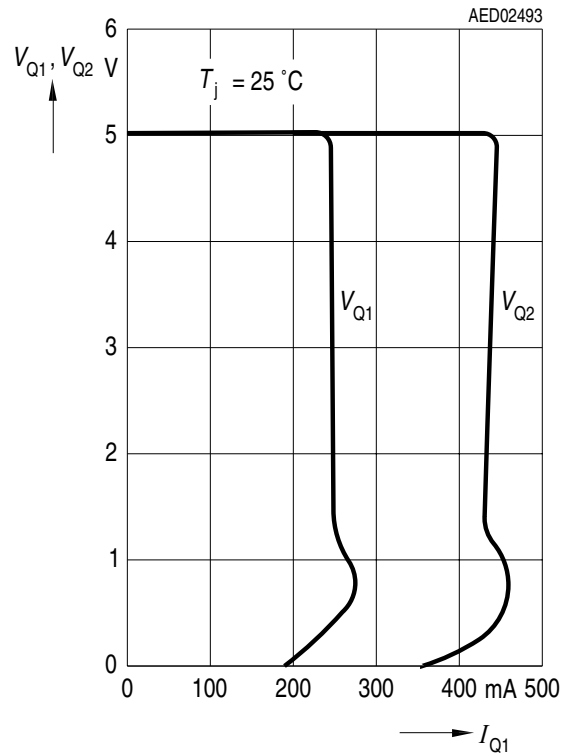

Drop Voltage  $V_{DRQ2}$  versus Output Current  $I_{Q2}$

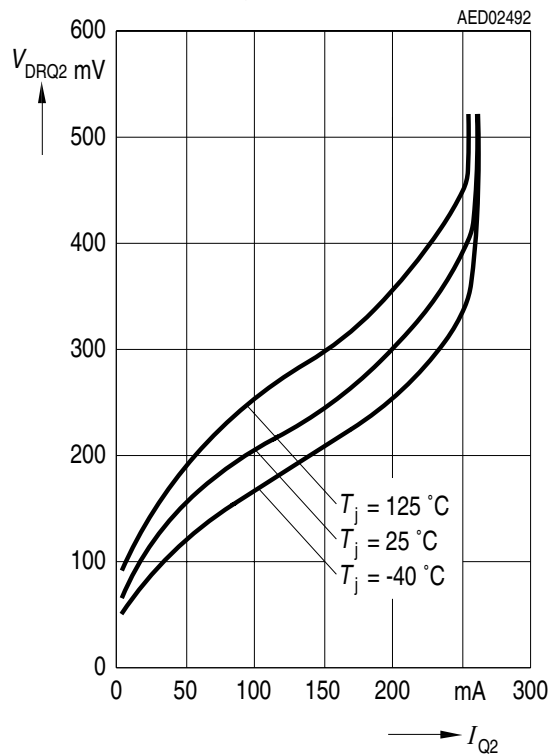

Output Voltage  $V_{Q1}$  versus Temperature  $T_j$

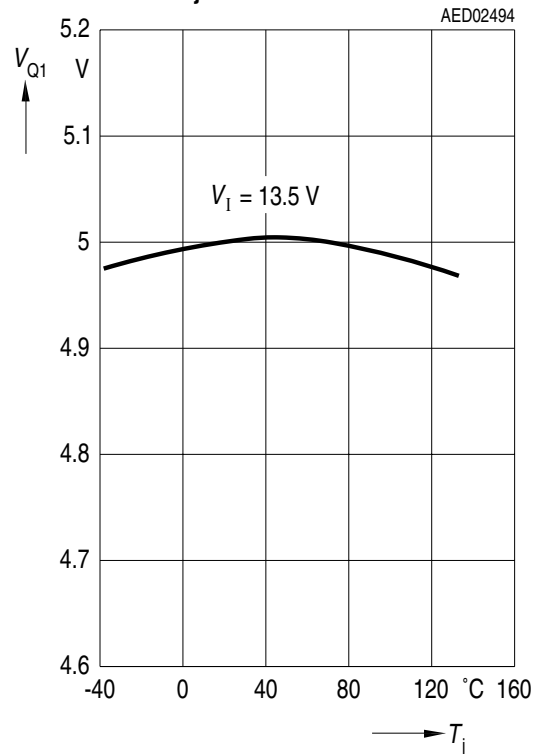

**Output Voltage  $V_{Q1}$ ,  $V_{Q2}$  versus Input Voltage  $V_I$  ( $V_{I1} = V_{I2}$ )**

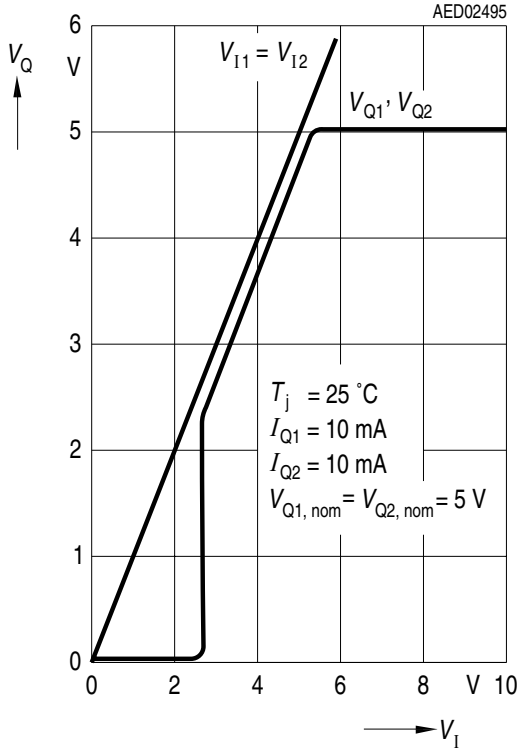

**Current Consumption  $I_q$  versus Output Current  $I_{Q1}$  (low load)**

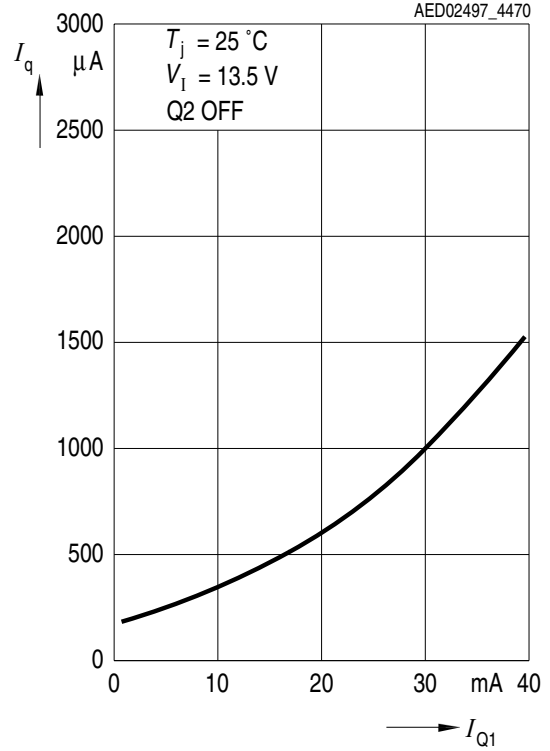

**Current Consumption  $I_q$  versus Input Voltage  $V_I$**

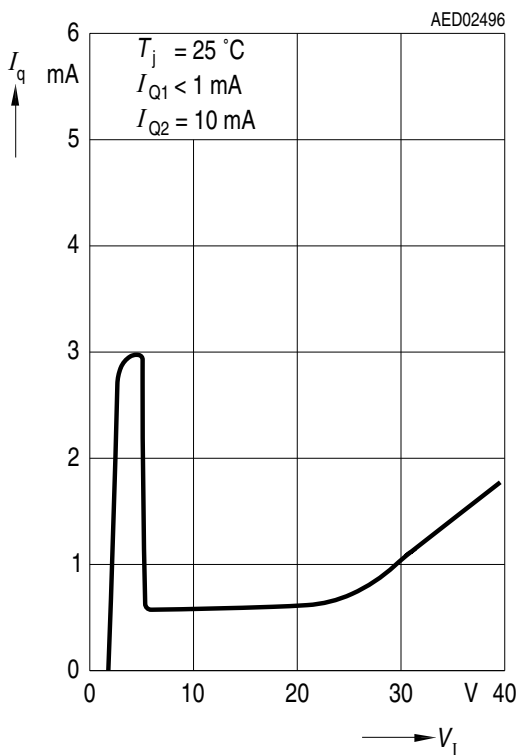

**Current Consumption  $I_q$  versus Output Current  $I_{Q1}$  (high load)**

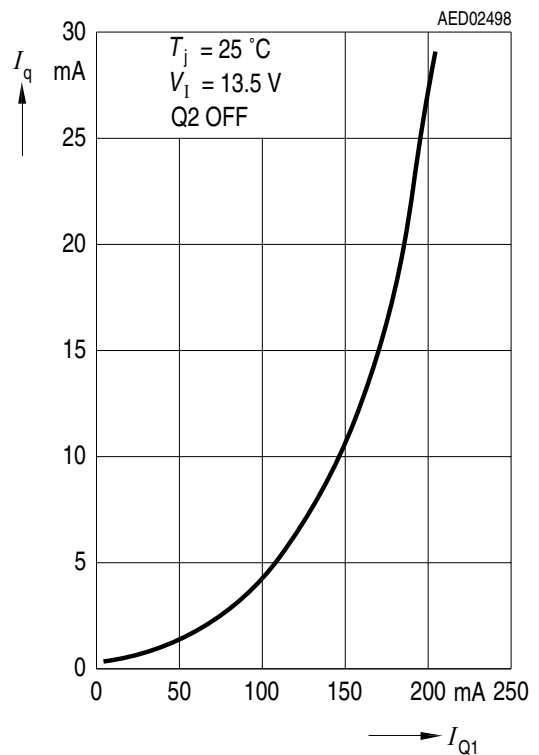

**Current Consumption  $I_q$  versus Output Current  $I_{Q2}$  (low load)**

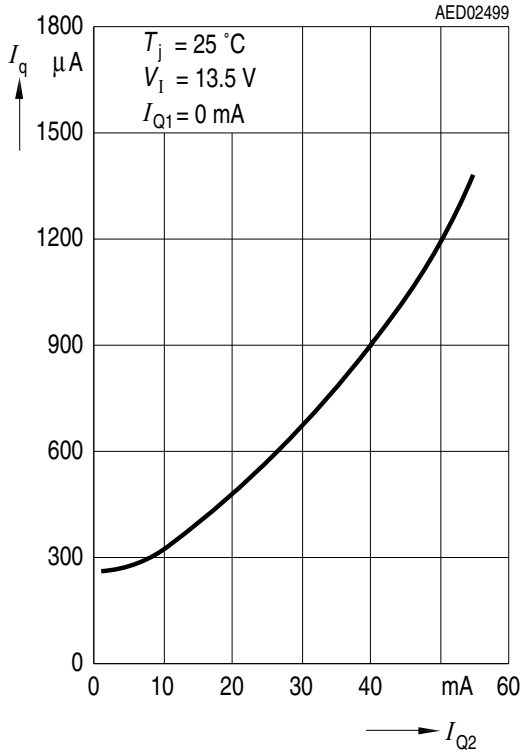

**Reset Adjust Threshold  $V_{RADJTH}$  versus Temperature  $T_j$**

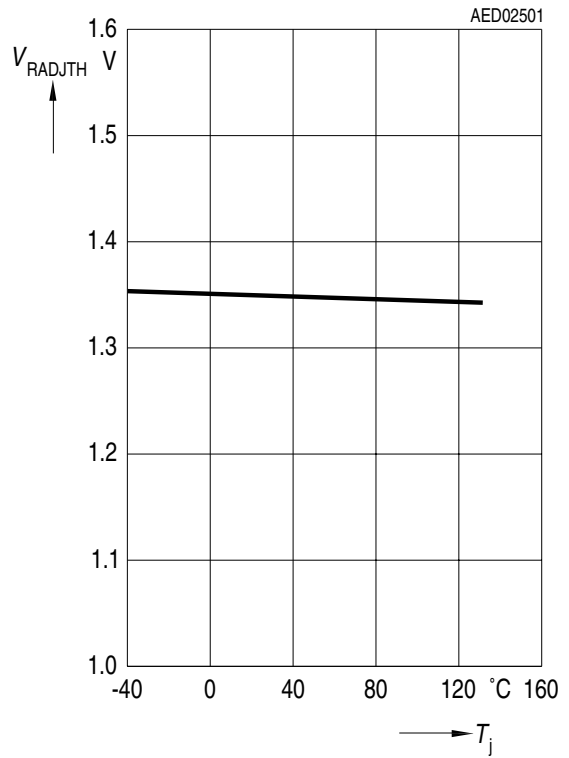

**Current Consumption  $I_q$  versus Output Current  $I_{Q2}$  (high load)**

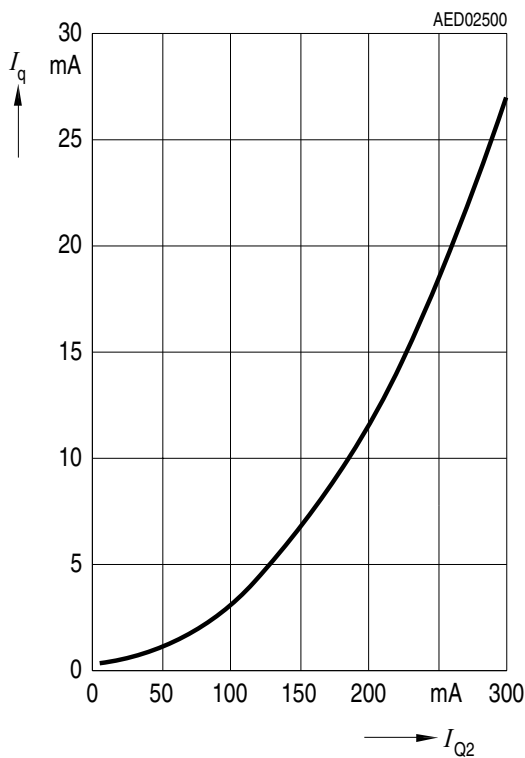

**Switching Voltage  $V_{DU}$ ,  $V_{DL}$  versus Temperature  $T_j$**

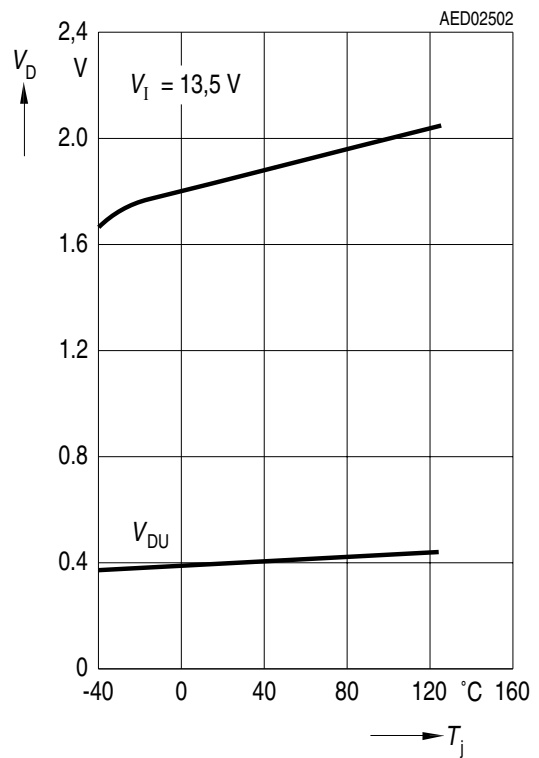

**Charge Current  $I_{D,c}$  versus Temperature  $T_j$**

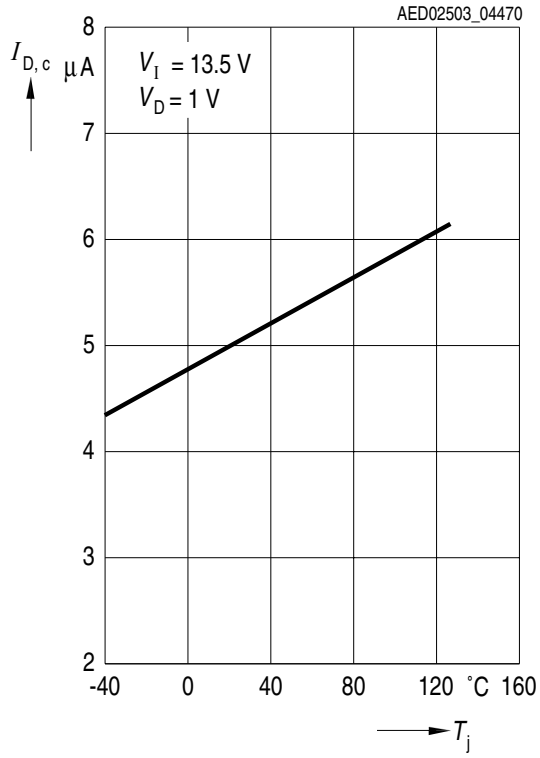

**Sense Threshold  $V_{SITH}$  versus Temperature  $T_j$**

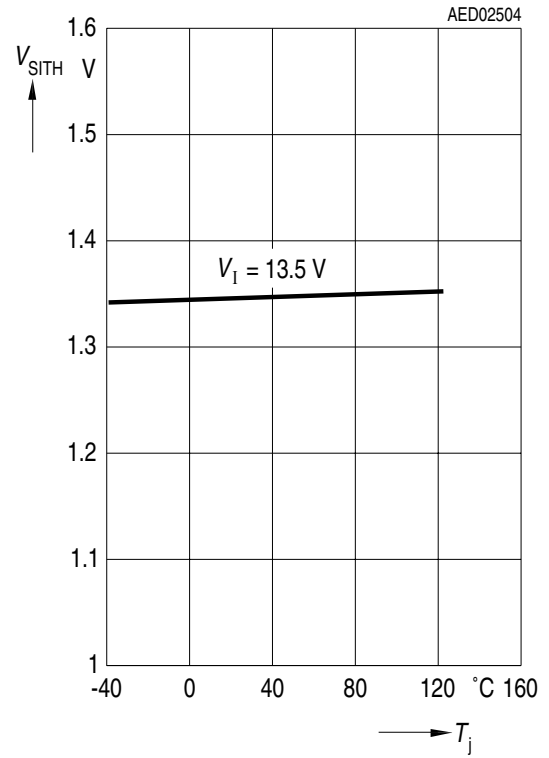

Package Outlines

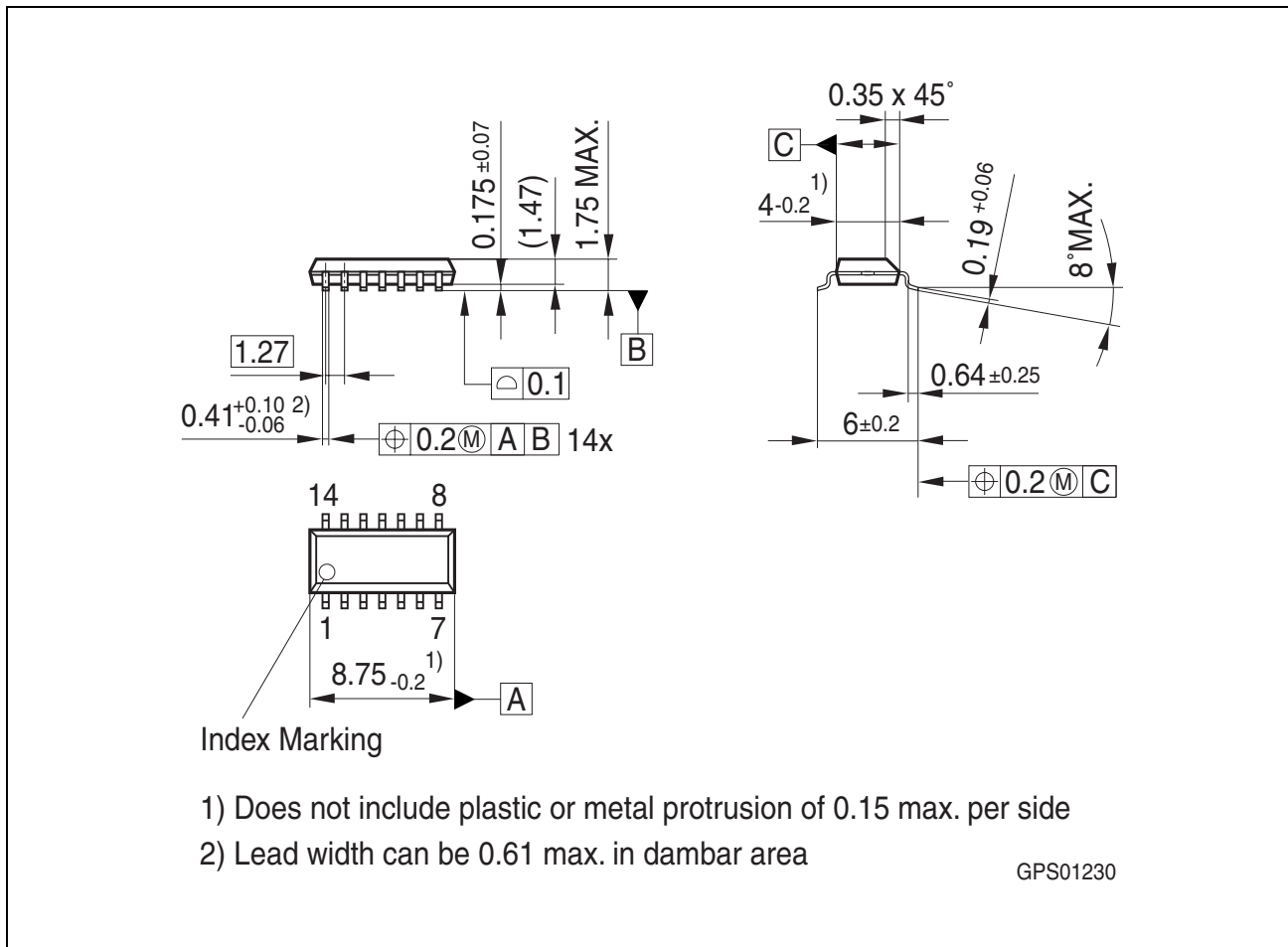

Figure 6 PG-DSO-14 (Plastic Green Dual Small Outline)

Green Product (RoHS compliant)

To meet the world-wide customer requirements for environmentally friendly products and to be compliant with government regulations the device is available as a green product. Green products are RoHS-Compliant (i.e Pb-free finish on leads and suitable for Pb-free soldering according to IPC/JEDEC J-STD-020).

You can find all of our packages, sorts of packing and others in our Infineon Internet Page "Products": <http://www.infineon.com/packages>.

SMD = Surface Mounted Device

Dimensions in mm

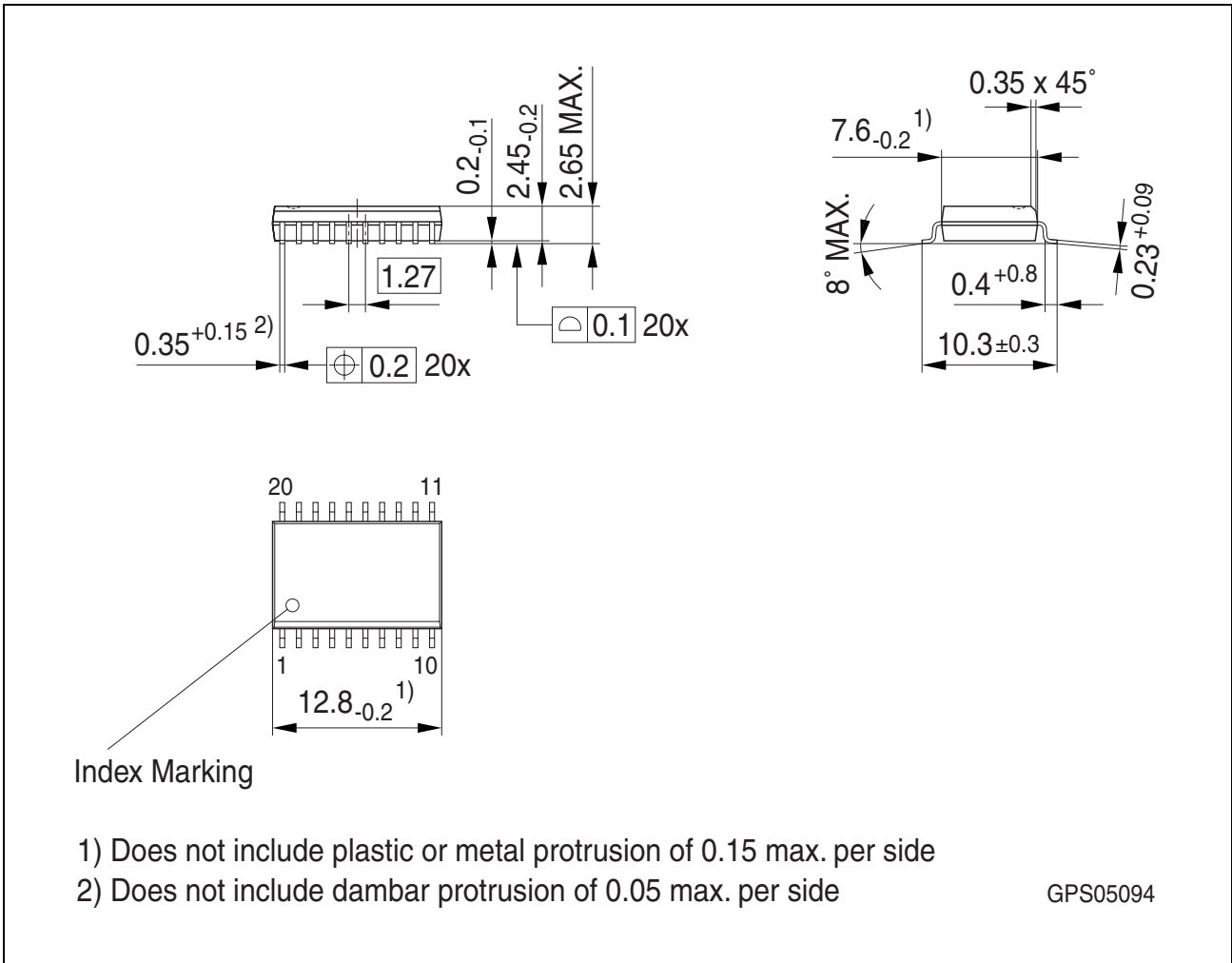

**Figure 7 PG-DSO-20 (Plastic Green Dual Small Outline)**

**Green Product (RoHS compliant)**

To meet the world-wide customer requirements for environmentally friendly products and to be compliant with government regulations the device is available as a green product. Green products are RoHS-Compliant (i.e Pb-free finish on leads and suitable for Pb-free soldering according to IPC/JEDEC J-STD-020).

You can find all of our packages, sorts of packing and others in our Infineon Internet Page "Products": <http://www.infineon.com/packages>.

SMD = Surface Mounted Device

Dimensions in mm

---

**Revision History**

<b>Version</b>	<b>Date</b>	<b>Changes</b>
Rev. 1.2	2008-03-20	Initial version of RoHS-compliant derivate of TLE 4470 <b>Page 1</b> : AEC certified statement added <b>Page 1</b> and <b>Page 21f</b> : RoHS compliance statement and Green product feature added <b>Page 1</b> and <b>Page 21f</b> : Package changed to RoHS compliant version Legal Disclaimer updated

**Edition 2008-03-20**

**Published by  
Infineon Technologies AG  
81726 Munich, Germany**

**© 2008 Infineon Technologies AG  
All Rights Reserved.**

### **Legal Disclaimer**

The information given in this document shall in no event be regarded as a guarantee of conditions or characteristics. With respect to any examples or hints given herein, any typical values stated herein and/or any information regarding the application of the device, Infineon Technologies hereby disclaims any and all warranties and liabilities of any kind, including without limitation, warranties of non-infringement of intellectual property rights of any third party.

### **Information**

For further information on technology, delivery terms and conditions and prices, please contact the nearest Infineon Technologies Office ([www.infineon.com](http://www.infineon.com)).

### **Warnings**

Due to technical requirements, components may contain dangerous substances. For information on the types in question, please contact the nearest Infineon Technologies Office.

Infineon Technologies components may be used in life-support devices or systems only with the express written approval of Infineon Technologies, if a failure of such components can reasonably be expected to cause the failure of that life-support device or system or to affect the safety or effectiveness of that device or system. Life support devices or systems are intended to be implanted in the human body or to support and/or maintain and sustain and/or protect human life. If they fail, it is reasonable to assume that the health of the user or other persons may be endangered.