

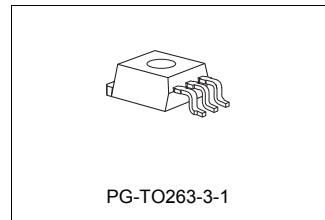

## Features

- Output voltage 5 V, 8.5 V or 10 V
- Output voltage tolerance  $\leq \pm 4\%$
- Current capability 400 mA
- Low-drop voltage
- Very low current consumption
- Short-circuit proof
- Reverse polarity proof
- Suitable for use in automotive electronics
- Green Product (RoHS compliant) version of TLE 4274
- AEC qualified

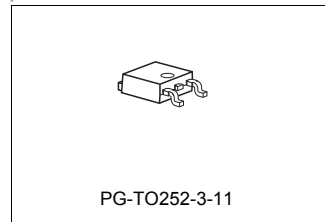
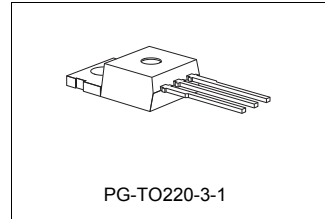

## Functional Description

The TLE 4274 is a low drop voltage regulator available in a TO220, TO252 and TO263 package. The IC regulates an input voltage up to 40 V to  $V_{Qrated} = 5.0\text{ V (V50)}$ ,  $8.5\text{ V (V85)}$  and  $10\text{ V (V10)}$ . The maximum output current is 400 mA. The IC is short-circuit proof and incorporates temperature protection that disables the IC at overtemperature. A 3.3 V and 2.5 V version is also available. For information about the low output voltage types please refer to the data sheet TLE 4274 / 3.3 V; 2.5 V.

Type	Package
TLE 4274 V10	PG-TO220-3-1 (RoHS compliant)
TLE 4274 V50	PG-TO220-3-1 (RoHS compliant)
TLE 4274 V85	PG-TO220-3-1 (RoHS compliant)
TLE 4274 DV50	PG-TO252-3-11 (RoHS compliant)
TLE 4274 GV10	PG-TO263-3-1 (RoHS compliant)
TLE 4274 GV50	PG-TO263-3-1 (RoHS compliant)
TLE 4274 GV85	PG-TO263-3-1 (RoHS compliant)

### **Dimensioning Information on External Components**

The input capacitor  $C_1$  is necessary for compensating line influences. Using a resistor of approx.  $1 \Omega$  in series with  $C_1$ , the oscillating of input inductivity and input capacitance can be damped. The output capacitor  $C_Q$  is necessary for the stability of the regulation circuit. Stability is guaranteed at values  $C_Q \geq 22 \mu\text{F}$  and an ESR of  $\leq 3 \Omega$  within the operating temperature range.

### **Circuit Description**

The control amplifier compares a reference voltage to a voltage that is proportional to the output voltage and drives the base of the series transistor via a buffer. Saturation control as a function of the load current prevents any oversaturation of the power element. The IC also includes a number of internal circuits for protection against:

- Overload
- Overtemperature
- Reverse polarity

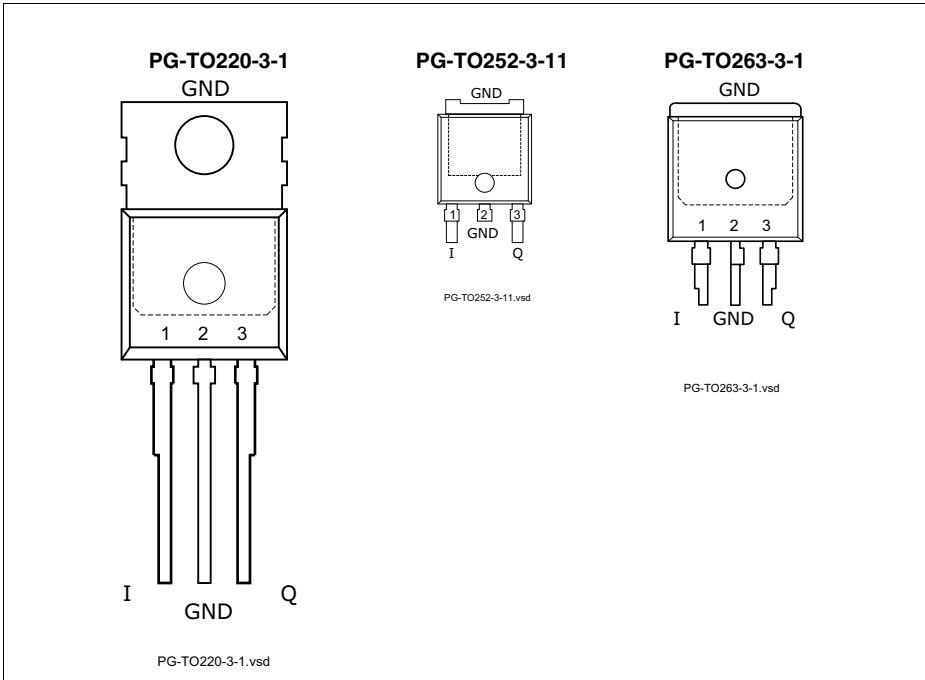

**Figure 1** Pin Configuration (top view)

**Table 1** Pin Definitions and Functions

Pin No.	Symbol	Function
1	I	<b>Input</b> ; block to ground directly at the IC with a ceramic capacitor.
2	GND	<b>Ground</b>
3	Q	<b>Output</b> ; block to ground with a $\geq 22 \mu\text{F}$ capacitor, $\text{ESR} \leq 3 \Omega$ .
TAB	-	<b>TAB</b> ; connect to heatsink and GND to improve thermal performance

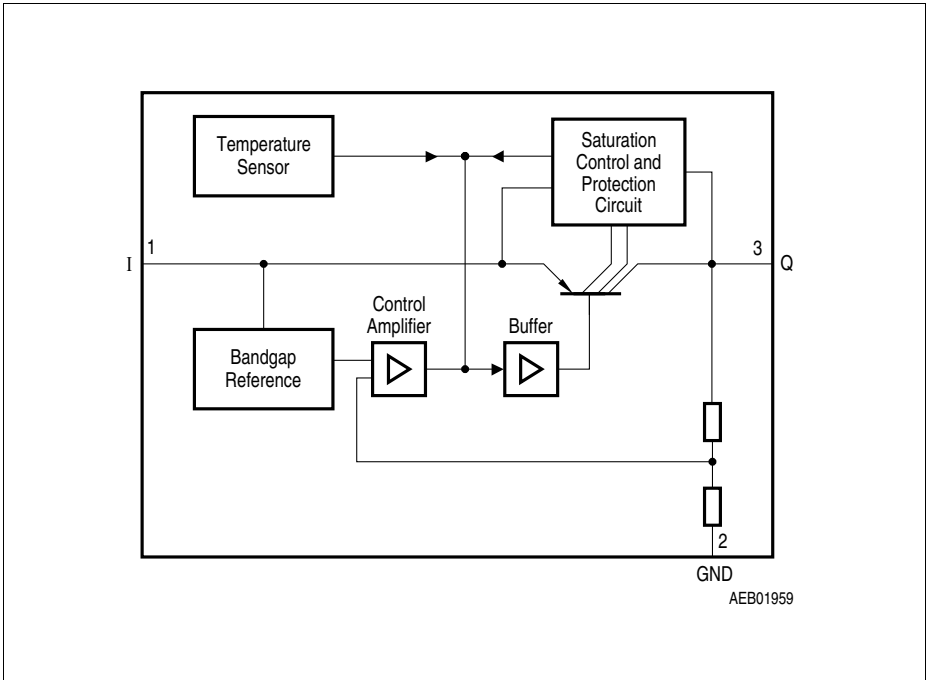

**Figure 2**    **Block Diagram**

**Table 2 Absolute Maximum Ratings**
 $T_j = -40$  to  $150$  °C

Parameter	Symbol	Limit Values		Unit	Test Condition
		Min.	Max.		
<b>Input</b>					
Voltage	$V_i$	-42	45	V	–
Current	$I_i$	–	–	–	Internally limited
<b>Output</b>					
Voltage	$V_Q$	-1.0	40	V	–
Current	$I_Q$	–	–	–	Internally limited
<b>Ground</b>					
Current	$I_{GND}$	–	100	mA	–
<b>Temperature</b>					
Junction temperature	$T_j$	–	150	°C	–
Storage temperature	$T_{stg}$	-50	150	°C	–

*Note: Maximum ratings are absolute ratings; exceeding any one of these values may cause irreversible damage to the integrated circuit.*

**Table 3 Operating Range**

Parameter	Symbol	Limit Values		Unit	Remarks
		Min.	Max.		
Input voltage; V50, DV50, GV50	$V_i$	5.5	40	V	–
Input voltage, V85, GV85	$V_i$	9.0	40	V	–
Input voltage, V10, GV10	$V_i$	10.5	40	V	–
Junction temperature	$T_j$	-40	150	°C	–
<b>Thermal Resistance</b>					
Junction ambient	$R_{thja}$	–	65	K/W	TO220 <sup>1)</sup>
Junction ambient	$R_{thja}$	–	78	K/W	TO252 <sup>1)</sup>
Junction ambient	$R_{thja}$	–	52	K/W	TO263 <sup>1)</sup>
Junction case	$R_{thjc}$	–	4	K/W	–

1) Worst case; regarding peak temperature, zero airflow mounted on PCB  $80 \times 80 \times 1.5$  mm<sup>3</sup>, 300 mm<sup>2</sup> heat sink area.

**Table 4 Characteristics**
 $V_I = 13.5 \text{ V}; -40 \text{ }^\circ\text{C} < T_j < 150 \text{ }^\circ\text{C}$  (unless otherwise specified)

Parameter	Symbol	Limit Values			Unit	Measuring Conditions
		Min.	Typ.	Max.		
Output voltage V50-Version	$V_Q$	4.8	5	5.2	V	$5 \text{ mA} < I_Q < 400 \text{ mA}$ $6 \text{ V} < V_I < 28 \text{ V}$
Output voltage V50-Version	$V_Q$	4.8	5	5.2	V	$5 \text{ mA} < I_Q < 200 \text{ mA}$ $6 \text{ V} < V_I < 40 \text{ V}$
Output voltage V85-Version	$V_Q$	8.16	8.5	8.84	V	$5 \text{ mA} < I_Q < 400 \text{ mA}$ $9.5 \text{ V} < V_I < 28 \text{ V}$
Output voltage V85-Version	$V_Q$	8.16	8.5	8.84	V	$5 \text{ mA} < I_Q < 200 \text{ mA}$ $9.5 \text{ V} < V_I < 40 \text{ V}$
Output voltage V10-Version	$V_Q$	9.6	10	10.4	V	$5 \text{ mA} < I_Q < 400 \text{ mA}$ $11 \text{ V} < V_I < 28 \text{ V}$
Output voltage V10-Version	$V_Q$	9.6	10	10.4	V	$5 \text{ mA} < I_Q < 200 \text{ mA}$ $11 \text{ V} < V_I < 40 \text{ V}$
Output current limitation <sup>1)</sup>	$I_Q$	400	600	–	mA	–
Current consumption; $I_q = I_I - I_Q$	$I_q$	–	100	220	$\mu\text{A}$	$I_Q = 1 \text{ mA}$
Current consumption; $I_q = I_I - I_Q$	$I_q$	–	8	15	mA	$I_Q = 250 \text{ mA}$
	$I_q$	–	20	30	mA	$I_Q = 400 \text{ mA}$
Drop voltage <sup>1)</sup>	$V_{dr}$	–	250	500	mV	$I_Q = 250 \text{ mA}$ $V_{dr} = V_I - V_Q$
Load regulation	$\Delta V_Q$	–	20	50	mV	$I_Q = 5 \text{ mA to } 400 \text{ mA}$
Line regulation	$\Delta V_Q$	–	10	25	mV	$\Delta V_I = 12 \text{ V to } 32 \text{ V}$ $I_Q = 5 \text{ mA}$
Power supply ripple rejection	$PSRR$	–	60	–	dB	$f_r = 100 \text{ Hz};$ $V_r = 0.5 \text{ Vpp}$
Temperature output voltage drift	$dV_Q/dT$	–	0.5	–	mV/K	–

<sup>1)</sup> Measured when the output voltage  $V_Q$  has dropped 100 mV from the nominal value obtained at  $V_I = 13.5 \text{ V}$ .

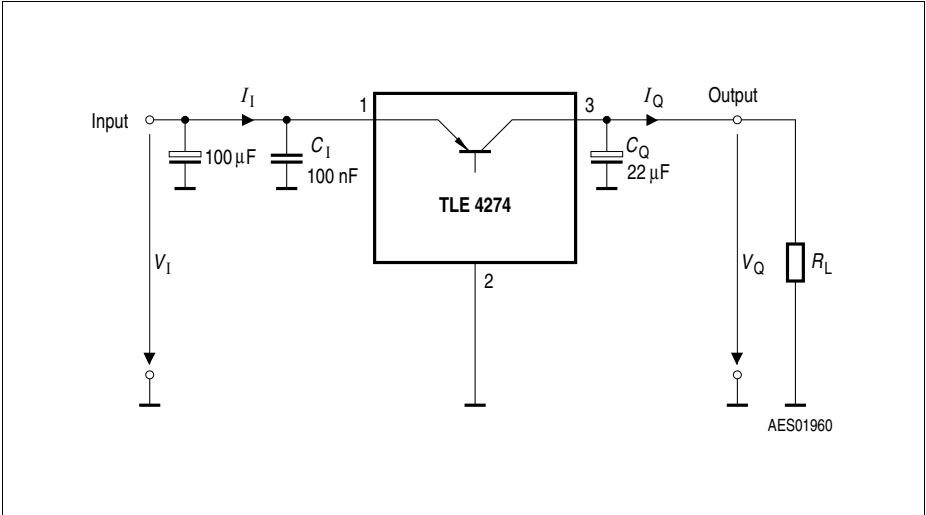

**Figure 3 Measuring Circuit**

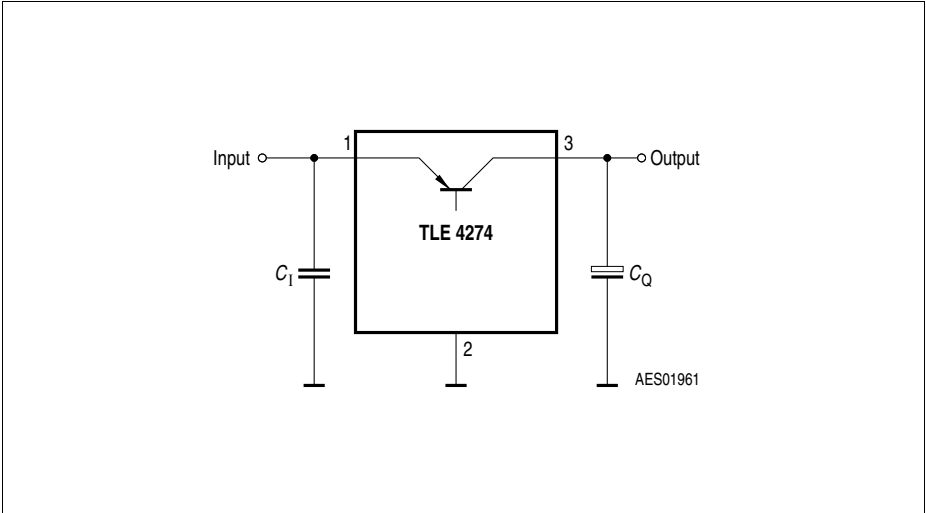

**Figure 4 Application Circuit**

Typical Performance Characteristics (V50, V85 and V10)

Drop Voltage  $V_{dr}$  versus Output Current  $I_Q$

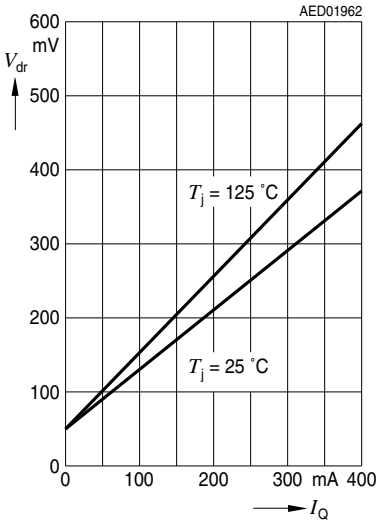

Output Current  $I_Q$  versus Input Voltage  $V_I$

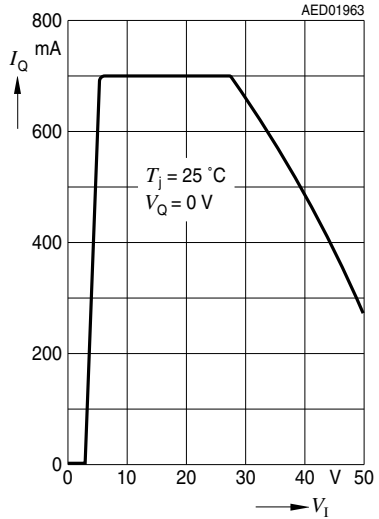

Current Consumption  $I_q$  versus Output Current  $I_Q$  (high load)

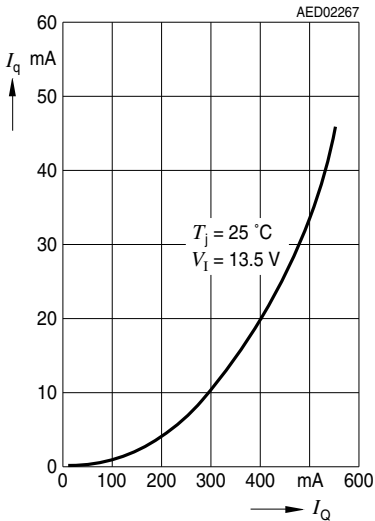

Current Consumption  $I_q$  versus Output Current  $I_Q$  (low load)

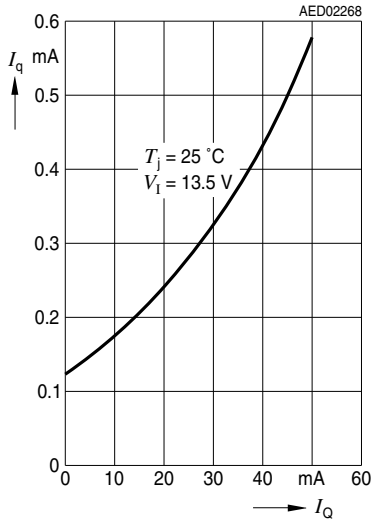



Typical Performance Characteristics (V50)

Output Voltage  $V_Q$  versus Junction Temperature  $T_j$

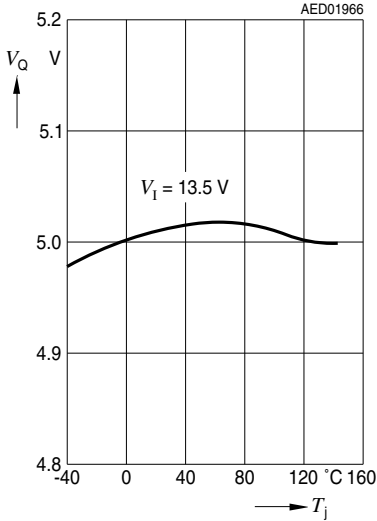

Current Consumption  $I_q$  versus Input Voltage  $V_I$

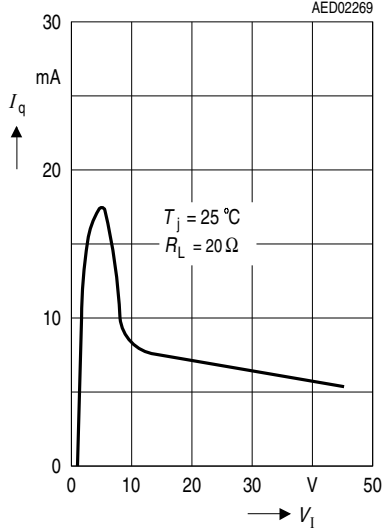

Output Voltage  $V_Q$  versus Input Voltage  $V_I$

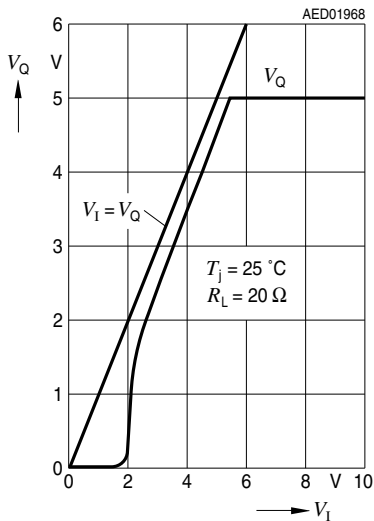

Input Current  $I_I$  versus Input Voltage  $V_I$

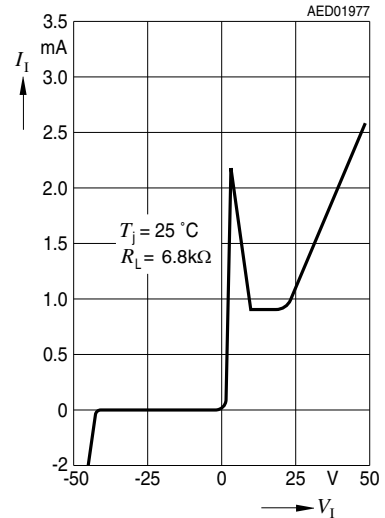

Typical Performance Characteristics for V85

Output Voltage  $V_Q$  versus Junction Temperature  $T_j$

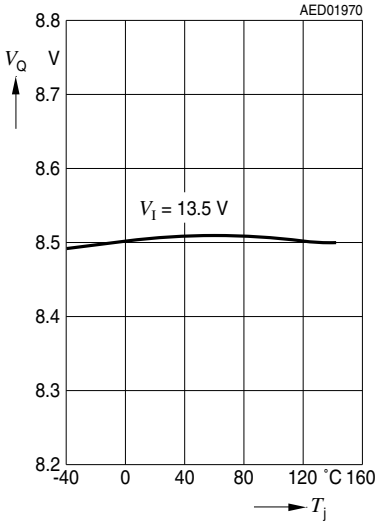

Current Consumption  $I_q$  versus Input Voltage  $V_i$

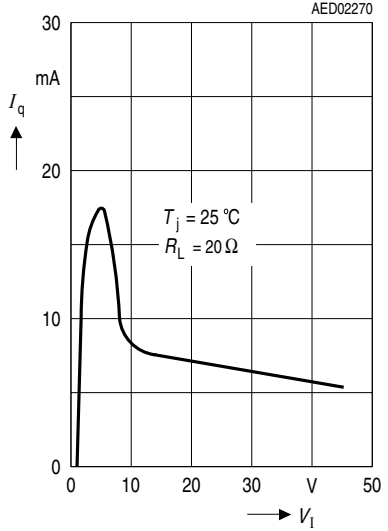

Output Voltage  $V_Q$  versus Input Voltage  $V_i$

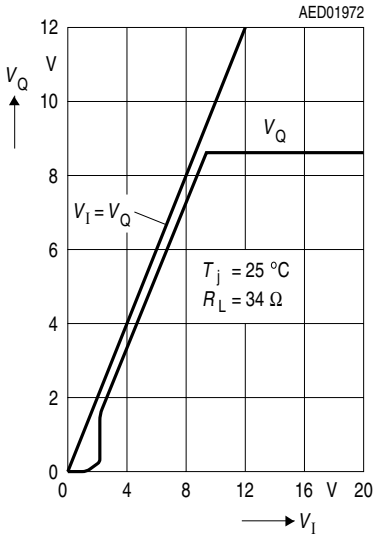

Input Current  $I_i$  versus Input Voltage  $V_i$

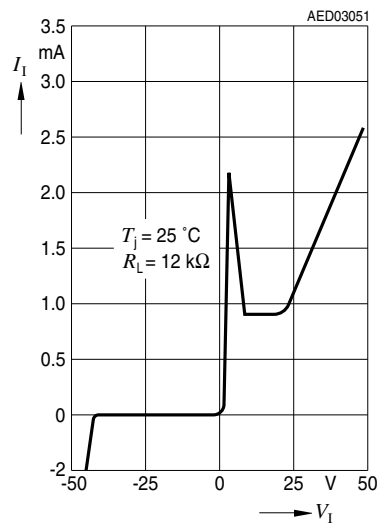

Typical Performance Characteristics for V10

Output Voltage  $V_Q$  versus Junction Temperature  $T_j$

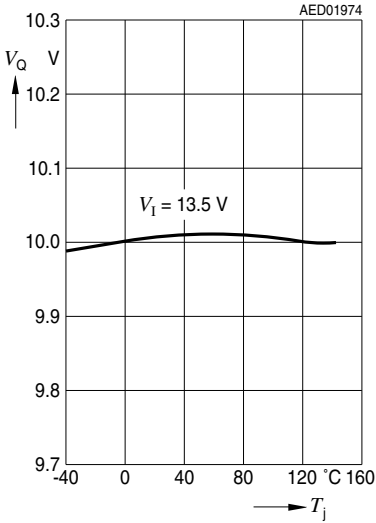

Current Consumption  $I_q$  versus Input Voltage  $V_I$

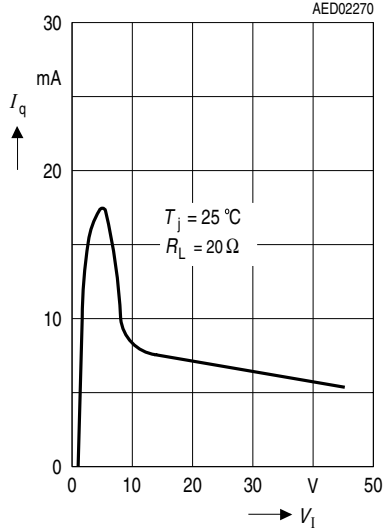

Output Voltage  $V_Q$  versus Input Voltage  $V_I$

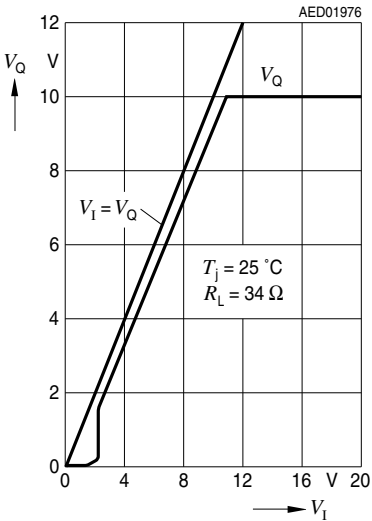

Input Current  $I_I$  versus Input Voltage  $V_I$

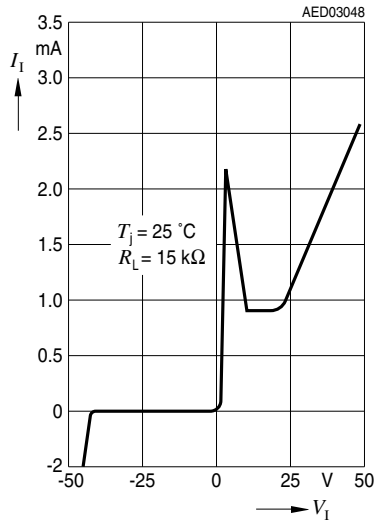

Package Outlines

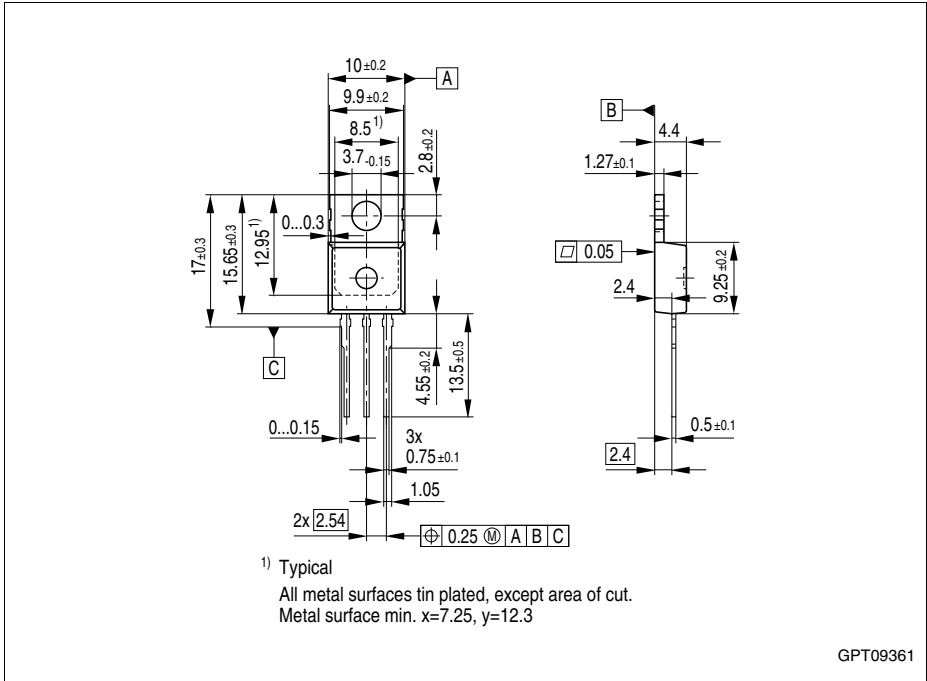

Figure 5 PG-TO220-3-1 (Plastic Transistor Single Outline)

Green Product (RoHS-Compliant)

To meet the world-wide customer requirements for environmentally friendly products and to be compliant with government regulations the device is available as a green product. Green products are RoHS-Compliant (i.e Pb-free finish on leads and suitable for Pb-free soldering according to IPC/JEDEC J-STD-020).

You can find all of our packages, sorts of packing and others in our Infineon Internet Page "Products": <http://www.infineon.com/products>.

SMD = Surface Mounted Device

Dimensions in mm

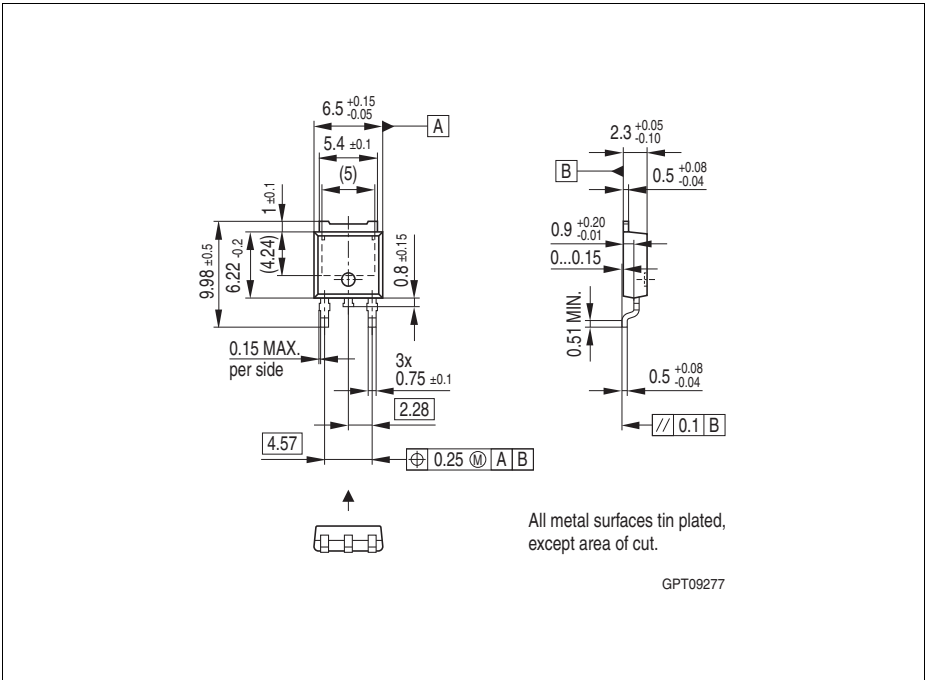

**Figure 6 PG-TO252-3-11 (Plastic Transistor Single Outline)**

**Green Product (RoHS-Compliant)**

To meet the world-wide customer requirements for environmentally friendly products and to be compliant with government regulations the device is available as a green product. Green products are RoHS-Compliant (i.e Pb-free finish on leads and suitable for Pb-free soldering according to IPC/JEDEC J-STD-020).

You can find all of our packages, sorts of packing and others in our Infineon Internet Page "Products": <http://www.infineon.com/products>.

SMD = Surface Mounted Device

Dimensions in mm

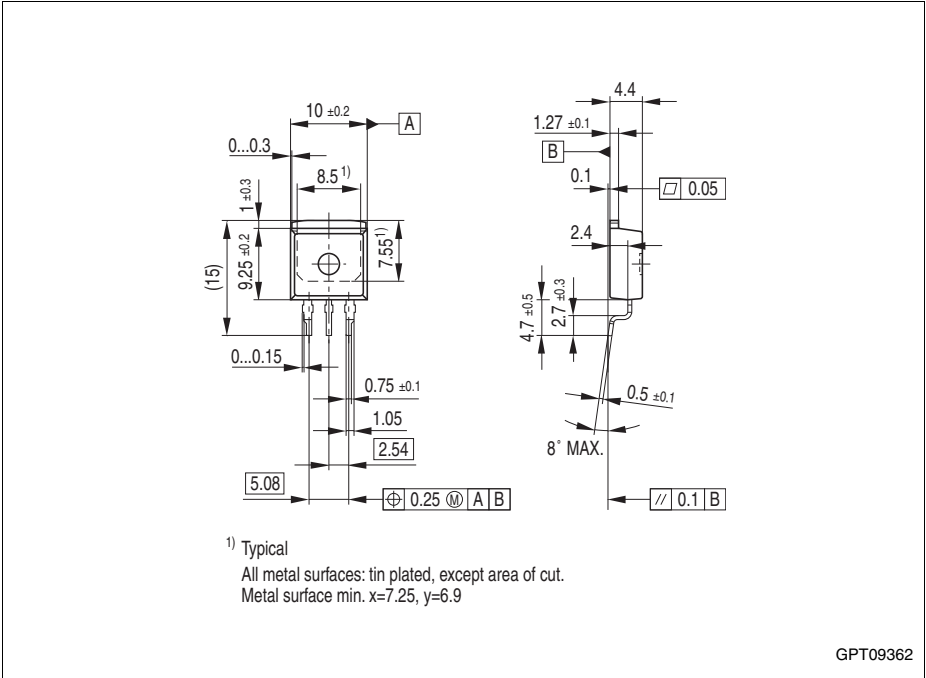

**Figure 7 PG-TO263-3-1 (Plastic Transistor Single Outline)**

**Green Product (RoHS-Compliant)**

To meet the world-wide customer requirements for environmentally friendly products and to be compliant with government regulations the device is available as a green product. Green products are RoHS-Compliant (i.e Pb-free finish on leads and suitable for Pb-free soldering according to IPC/JEDEC J-STD-020).

You can find all of our packages, sorts of packing and others in our Infineon Internet Page "Products": <http://www.infineon.com/products>.

SMD = Surface Mounted Device

Dimensions in mm

**Revision History**

<b>Version</b>	<b>Date</b>	<b>Changes</b>
Rev. 1.6	2007-02-16	Updated Infineon logo Added "AEC" and "Green" logo Added "Green Product" and "AEC qualified" to the feature list Added "Green Product" remark Updated Package Names to "PG-xxx" Removed leadframe variant "P-TO-252-1" Disclaimer Update
Rev. 1.7	2011-01-20	Added TAB potential to the package outline

**Edition 2011-01-20**

**Published by  
Infineon Technologies AG  
81726 München, Germany**

**© Infineon Technologies AG 2007.  
All Rights Reserved.**

#### **Legal Disclaimer**

The information given in this document shall in no event be regarded as a guarantee of conditions or characteristics ("Beschaffenheitsgarantie"). With respect to any examples or hints given herein, any typical values stated herein and/or any information regarding the application of the device, Infineon Technologies hereby disclaims any and all warranties and liabilities of any kind, including without limitation warranties of non-infringement of intellectual property rights of any third party.

#### **Information**

For further information on technology, delivery terms and conditions and prices please contact your nearest Infineon Technologies Office ([www.infineon.com](http://www.infineon.com)).

#### **Warnings**

Due to technical requirements components may contain dangerous substances. For information on the types in question please contact your nearest Infineon Technologies Office.

Infineon Technologies Components may only be used in life-support devices or systems with the express written approval of Infineon Technologies, if a failure of such components can reasonably be expected to cause the failure of that life-support device or system, or to affect the safety or effectiveness of that device or system. Life support devices or systems are intended to be implanted in the human body, or to support and/or maintain and sustain and/or protect human life. If they fail, it is reasonable to assume that the health of the user or other persons may be endangered.