

TOSHIBA CMOS Integrated Circuit Silicon Monolithic

TC78B016FTG

3-Phase Sine-Wave PWM Driver for Brushless DC Motors

This product is a three-phase sine-wave PWM driver for brushless motors. It controls motor rotation speed by changing the PWM duty cycle, based on the speed control input. Hall signal is supported to three sensor.

Features

- Built-in Auto lead angle architecture (InPAC : Intelligent Phase Control)
- Three-phase full wave drive
- Sine-wave PWM drive
- Hall amplifier (hall element / hall IC)
- Power supply: absolute maximum voltage: 40 V
- Output current: absolute maximum current: 3 A
- Selectable rotational speed command input signal:
 - Pulse duty signal input/ analog voltage input
- Selectable PWM frequency
- Adjustable minimum duty in PWM control
- Adjustable speed ratio in PWM control
- Selectable lead angle control function:
 - Auto lead angle function (proportion to frequency /phase control)
 - External lead angle control (32 steps correspond to 0° to 58°)
- Selectable rotation direction
- Brake function terminal
- Selectable lock detection function
- Restart function
- Rotation frequency signal (FG_OUT):
 - 1 pulse/ electrical angle 360°, 3 pulses/ electrical angle 360°
- Lock detection signal (LD_OUT)
- Power supply voltage monitoring function
- Overcurrent detection circuit (ISD)
- Thermal shutdown circuit (TSD)
- Under voltage lockout circuit (UVLO)
- Current limit circuit: external sensing resistor
- Adjustable start conditions

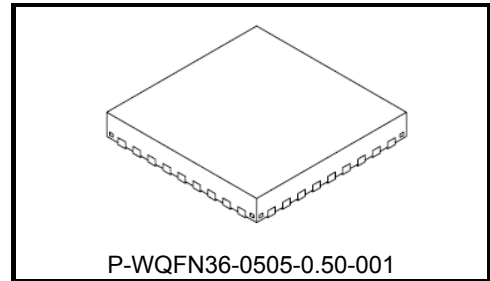

Weight: 0.06 g (typ.)

Pin assignment

(Top view)

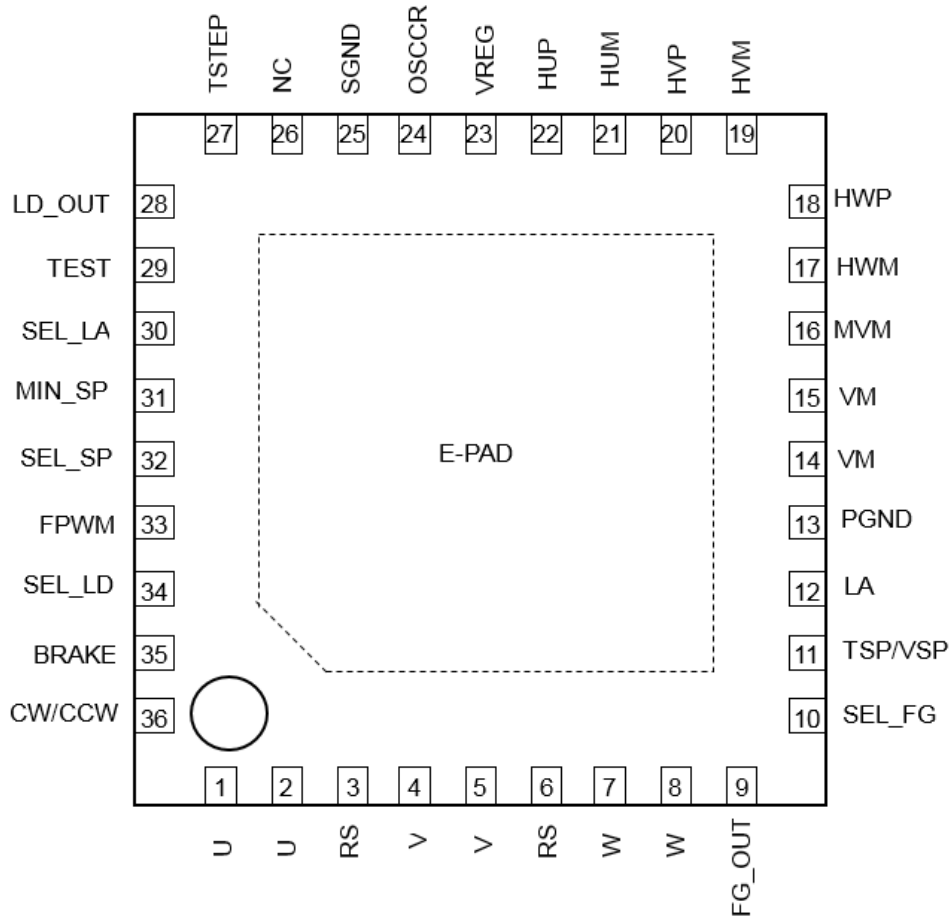

Note 1: Design the pattern in consideration of the heat design because the back side (E-PAD) have the role of heat radiation. The back side (E-PAD) should be connected to GND because it is connected to the back of the chip electrically.

Note 2: There are five pairs of terminals named U, V, W, VM and RS. Connect two each of the terminals which has the same pin symbol via external patterns. Regarding GND, connect SGND to PGND via external patterns.

Pin description

| Pin No. | Symbol | I/O | Description |
|---------|---------|-----|---|
| 1 | U | O | Output terminal for U phase |
| 2 | U | O | Output terminal for U phase |
| 3 | RS | — | Terminal for connecting to output current sensing resistor |
| 4 | V | O | Output terminal for V phase |
| 5 | V | O | Output terminal for V phase |
| 6 | RS | — | Terminal for connecting to output current sensing resistor |
| 7 | W | O | Output terminal for W phase |
| 8 | W | O | Output terminal for W phase |
| 9 | FG_OUT | O | Output terminal for rotation frequency |
| 10 | SEL_FG | I | Selectable terminal for FG frequency division ratio |
| 11 | TSP/VSP | I | Input terminal for rotational speed command |
| 12 | LA | I | Input terminal for setting lead angle |
| 13 | PGND | — | Power ground terminal |
| 14 | VM | — | Power supply terminal for motor |
| 15 | VM | — | Power supply terminal for motor |
| 16 | MVM | I | Power supply monitoring |
| 17 | HWM | I | W-phase Hall-signal input(-) |
| 18 | HWP | I | W-phase Hall-signal input (+) |
| 19 | HVM | I | V-phase Hall-signal input (-) |
| 20 | HVP | I | V-phase Hall-signal input (+) |
| 21 | HUM | I | U-phase Hall-signal input (-) |
| 22 | HUP | I | U-phase Hall-signal input (+) |
| 23 | VREG | — | Output terminal for reference voltage (5 V) |
| 24 | OSCCR | — | Terminal for setting internal oscillator circuit |
| 25 | SGND | — | Signal ground terminal |
| 26 | NC | — | Non connection terminal |
| 27 | TSTEP | — | Terminal for setting acceleration and deceleration control |
| 28 | LD_OUT | O | Output terminal for lock detection |
| 29 | TEST | I | Terminal for test |
| 30 | SEL_LA | I | Input terminal for selecting a method of lead angle control |
| 31 | MIN_SP | I | Input terminal for setting minimum output on duty |
| 32 | SEL_SP | I | Input terminal for selecting a method of rotational speed command |
| 33 | FPWM | I | Input terminal for selecting PWM frequency |
| 34 | SEL_LD | I | Selectable terminal for motor lock detection function |
| 35 | BRAKE | I | Brake on/off terminal |
| 36 | CW/CCW | I | Input terminal for selecting rotation direction |

I/O Equivalent circuits

The equivalent circuit diagrams may be simplified or some parts of them may be omitted for explanatory purposes.

| Pin symbol | I/O Signal | I/O Internal Circuit |
|--|--|----------------------|
| HUP HUM HVP HVM HWP HWM | Input terminal Hysteresis ± 8 mV (typ.) | |
| CW/CCW BRAKE | Input terminal H: 2 V (minimum) L: 0.8 V (maximum) | |
| SEL_SP SEL_LA | Input terminal When leaving the terminal open, it is set to Middle level. When leaving the terminal open, plenty of evaluations using actual systems are required before using. | |
| SEL_FG MIN_SP LA FPWM SEL_LD | Input terminal Applying a voltage to the terminals is required. | |
| TSP/VSP | Input terminal for rotational speed command | |

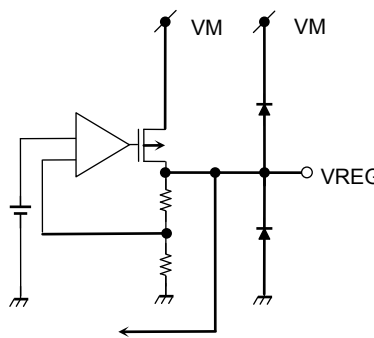
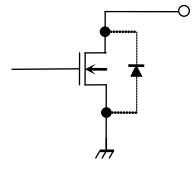
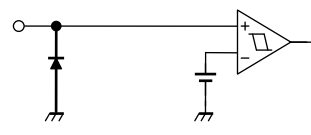
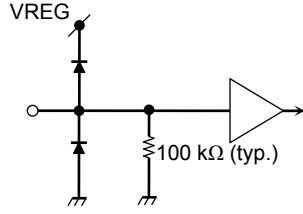
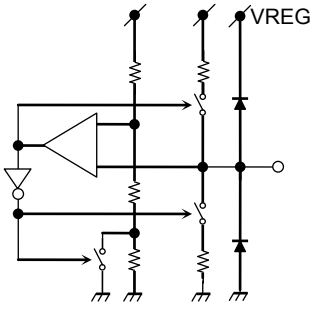
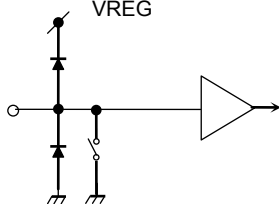
| Pin symbol | I/O Signal | I/O Internal Circuit |
|------------------|--|---|
| VREG | <p>Output terminal for reference voltage</p> <p>VREG = 5 V (typ.)</p> <p>Connect a capacitor (Recommended value: 0.1 μF) for voltage stability to SGND.</p> |  |
| FG_OUT LD_OUT | <p>Open drain output</p> <p>Connect the terminal to the high level via an external pull-up resistor so that it outputs a high level signal.</p> |  |
| MVM | <p>Input terminal for power supply monitoring</p> <p>Applying a voltage to the terminals is required.</p> |  |
| TEST | <p>Test terminal</p> <p>Connect to SGND.</p> |  |
| TSTEP | <p>Terminal for setting acceleration and deceleration control</p> <p>Connect a capacitor to SGND.</p> |  |
| OSCCR | <p>Terminal for setting time to reach PWM duty ratio</p> <p>Connect 27 kΩ to SGND and 360 pF to VREG.</p> |  |

| Pin symbol | I/O Signal | I/O Internal Circuit |
|-------------------------|--|----------------------|
| VM U V W RS | <p>VM: Power supply terminal for motor</p> <p>U: Output terminal for U phase</p> <p>V: Output terminal for V phase</p> <p>W: Output terminal for W phase</p> <p>RS: Terminal for connecting to output current sensing resistor</p> | |

Absolute Maximum Ratings (Note) (Ta = 25°C)

| Characteristics | Symbol | Rating | Unit |
|-----------------------|---------------------------|--------------------------------|------|
| Power supply voltage | VM | 40 | V |
| Input voltage | V _{IN1} (Note1) | -0.3 to 6 | V |
| | V _{IN2} (Note2) | -0.3 to V _{REG} + 0.3 | V |
| | V _{IN3} (Note3) | -0.3 to 2.5 | V |
| Output voltage | V _{OUT1} (Note4) | 40 | V |
| | V _{OUT2} (Note5) | 40 | V |
| Output current | I _{OUT1} (Note6) | 3 (Note9) | A |
| | I _{OUT2} (Note7) | 10 | mA |
| | I _{OUT3} (Note8) | 40 | mA |
| Power dissipation | P _D | 4.1 (Note10) | W |
| Operating temperature | T _{opr} | -40 to 105 | °C |
| Storage temperature | T _{stg} | -55 to 150 | °C |

Note: The absolute maximum ratings of a semiconductor device are a set of ratings that must not be exceeded, even for a moment. Do not exceed any of these ratings. Exceeding the ratings may cause the device breakdown, damage or deterioration, and may result injury by explosion or combustion. Please use the TC78B016FTG within the specified operating ranges.

Note 1: Terminal for V_{IN1}: TSP/VSP, CW/CCW, BRAKE

Note 2: Terminal for V_{IN2}: HUP, HUM, HVP, HVM, HWP, HWM, SEL_LD, SEL_FG, CW/CCW, BRAKE, MIN_SP, MVM, SEL_SP, LA, FPWM, SEL_LA, TEST

Note 3: Terminal for V_{IN3}: RS

Note 4: Terminal for V_{OUT1}: U, V, W

Note 5: Terminal for V_{OUT2}: FG_OUT, LD_OUT

Note 6: Terminal for I_{OUT1}: U, V, W

Note 7: Terminal for I_{OUT2}: FG_OUT, LD_OUT

Note 8: Terminal for I_{OUT3}: VREG

Note 9: Output current may be limited by the ambient temperature or the device implementation. The maximum junction temperature should not exceed T_{j(max)} = 150°C.

Note 10: When mounted on a board (4 layers, FR4, 76.2 mm × 114.3 mm × 1.6 mm), R_{th(j-a)} = 30.5°C/W

Operating Ranges

| Characteristics | Symbol | Min | Max | Unit |
|----------------------|------------|-----|-----|------|
| Power supply voltage | V_{Mopr} | 6 | 30 | V |

Power dissipation (Reference data)

When mounted on a board (4 layers, FR4, 76.2 mm × 114.3 mm × 1.6 mm), $R_{th(j-a)} = 30.5^{\circ}\text{C/W}$

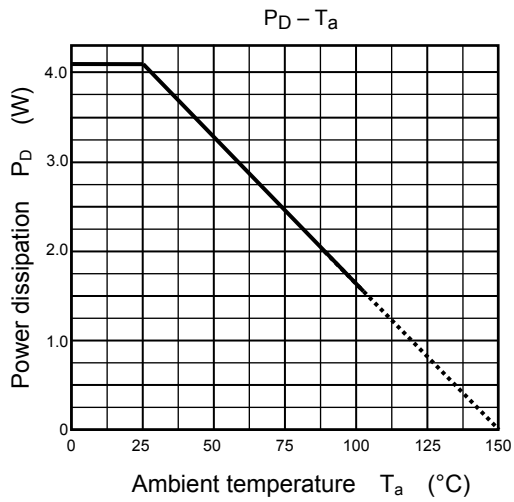

Electrical Characteristics (Ta = 25°C)

| Characteristics | | Symbol | Test Conditions | Min | Typ. | Max | Unit |
|--|---------------------------------|--|-----------------------------|------------|------|------|------|
| Power supply current | | IM | IVreg = 0 mA | — | 6.0 | 8.5 | mA |
| Input current | IIN1A | TSP/VSP (SEL_SP = VREG) | -1 | — | 1 | μA | |
| | IIN1D(H) | TSP/VSP = 5 V (SEL_SP = Open, GND) | — | 100 | 150 | | |
| | IIN1D(L) | TSP/VSP = 0 V (SEL_SP = Open, GND) | -1 | — | 1 | | |
| | IIN2 | SEL_FG, MIN_SP, LA, FPWM, SEL_LD | -1 | — | 1 | | |
| | IN3(H) | VIN = 5 V FST, SEL_SP, LA, SEL_LA | — | 100 | 150 | | |
| | IN3(L) | VIN = 0 V FST, SEL_SP, LA, SEL_LA | -150 | -100 | — | | |
| | IN4(H) | VIN = 5 V CW/CCW, BRAKE | — | 100 | 150 | | |
| | IN4(L) | VIN = 0 V CW/CCW, BRAKE, | -1 | 0 | — | | |
| | IN5 | MVM | -1 | — | 1 | | |
| Hall element input | Input sensitivity | VS | Differential input | 40 | — | — | mVpp |
| | Common-mode input voltage range | VW | — | 0.5 | — | 3.5 | V |
| | Input hysteresis | VH | (Reference data) | ±4 | ±8 | ±12 | mV |
| Hall IC input | | VIN4 | H HUP, HVP, HWP: | VREG -1 | — | VREG | V |
| | | | L HUM, HVM, HWM = VREG/2 | 0 | — | 0.8 | |
| Input voltage | VIN1 (H) | TSP/VSP | 2.0 | — | 5.5 | V | |
| | VIN1 (L) | (SEL_SP = Open, GND) | GND | — | 0.8 | | |
| | VIN2 (H) | CW/CCW, BRAKE | 2.0 | — | 5.5 | | |
| | VIN2 (L) | CW/CCW, BRAKE | GND | — | 0.8 | | |
| | VIN3 (H) | MVM L→H: sine-wave drive →120 degree commutation | 1.9 | 2.0 | 2.1 | | |
| | VIN3 (L) | MVM H→L: 120 degree commutation → sine wave drive | 1.7 | 1.8 | 1.9 | | |
| Input hysteresis range | V1hys | (Reference data) TSP/VSP SEL_SP = GND | 0.3 | 0.4 | 0.5 | V | |
| | V2hys | (Reference data) CW/CCW, BRAKE | 0.3 | 0.4 | 0.5 | | |
| Output low voltage at FG_OUT/LD_OUT | VOUT | IOUT = 5mA | GND | — | 0.5 | V | |
| Leak current at FG_OUT/LD_OUT | ILOUT | VOUT = 30V | — | 0 | 2 | μA | |
| Output on resistance at U, V, W | RON (H+L) | (IOUT = 1 A) | — | 0.24 | 0.33 | Ω | |
| Output leak current at U, V, W | IL (H) | VOUT = 0 V | -10 | 0 | — | μA | |
| | IL (L) | VOUT = 30 V | — | 0 | 10 | | |
| Masking time for detecting current limit | TRS | (Reference data) | — | 1.2 | — | μs | |

| Characteristics | Symbol | Test Conditions | Min | Typ. | Max | Unit |
|--|---------|---|-------|-------|-------|------|
| Current sensing voltage at RS terminal | VRS | — | 0.225 | 0.25 | 0.275 | V |
| PWM oscillation frequency | FPWM3 | (Reference data) FPWM = "3" | 22.5 | 25 | 27.5 | kHz |
| | FPWM2 | (Reference data) FPWM = "2" | 180 | 200 | 220 | |
| | FPWM1 | (Reference data) FPWM = "1" | 90 | 100 | 110 | |
| | FPWM0 | (Reference data) FPWM = "0" | 45 | 50 | 55 | |
| OSC frequency | OSC | (Reference data) OSCCR: 27 kΩ, 360 pF | 11.7 | 13 | 14.3 | MHz |
| Setting time at TSTEP terminal | Tsoft | (Reference data) TSTEP = 0.01μF | — | 0.100 | — | s |
| Lock detection time | Tlock1 | (Reference data) SEL_LD = "0" | — | 0.5 | — | s |
| restart time after lock | Tlock2 | (Reference data) SEL_LD = "0" | — | 5 | — | s |
| Masking time for detecting overcurrent | TISD | (Reference data) | — | 1.9 | — | μs |
| Current when overcurrent detection operates | ISD | (Reference data) | 3 | 4.5 | 6 | A |
| Thermal shutdown circuit | TSD | (Reference data) | 150 | 165 | 180 | °C |
| | TSDhys | (Reference data) Hysteresis for restart | — | 15 | — | |
| Voltage when low voltage lockout at VM terminal detects | VMUVLO | — | 5.0 | 5.3 | 5.7 | V |
| Voltage when low voltage lockout at VM terminal restarts | VMUVLOR | — | 5.3 | 5.6 | 6.0 | V |
| VREG output voltage | VREG | IVREG = -40 mA (Note) | 4.7 | 5 | 5.3 | V |

*(Reference data): No shipping inspection

(Note) There is a possibility that VREG output voltage does not reach the minimum value in the above Electrical Characteristics when the power supply voltage is less than the operating ranges. Moreover, it depends on VM and IVREG. Therefore, confirm there are not any problems by evaluating actual systems at about VMUVLO of VM.

The relation of Setting steps and input voltage

| SEL_SP SEL_LA | SEL_FG | FPWM SEL_LD | MIN_SP | LA (SEL_LA = "1") | LA (SEL_LA = "0", "2") | Input voltage (Written by VREG) | | Input voltage (When VREG = 5V) | |
|------------------|--------|----------------|--------|----------------------|---------------------------|------------------------------------|--------------|-----------------------------------|-------|
| | | | | | | Min | Max | Min | Max |
| 2 | 1 | 3 | 8 | 7 | 31 | Vreg/256*160 | Vreg | 3.125 | 5 |
| | | | | | 30 | Vreg/256*155 | Vreg/256*159 | 3.027 | 3.105 |
| 7 | | 6 | 29 | Vreg/256*150 | Vreg/256*154 | 2.93 | 3.008 | | |
| | | | 28 | Vreg/256*145 | Vreg/256*149 | 2.832 | 2.910 | | |
| 6 | | 5 | 27 | Vreg/256*140 | Vreg/256*144 | 2.734 | 2.813 | | |
| | | | 26 | Vreg/256*135 | Vreg/256*139 | 2.637 | 2.715 | | |
| 5 | | 4 | 25 | Vreg/256*130 | Vreg/256*134 | 2.539 | 2.617 | | |
| | | | 24 | Vreg/256*125 | Vreg/256*129 | 2.441 | 2.520 | | |
| 1 | | 2 | 6 | 5 | 23 | Vreg/256*120 | Vreg/256*124 | 2.344 | 2.422 |
| | | | | | 22 | Vreg/256*115 | Vreg/256*119 | 2.246 | 2.324 |
| 0 | 0 | 1 | 4 | 21 | Vreg/256*110 | Vreg/256*114 | 2.148 | 2.227 | |
| | | | | 20 | Vreg/256*105 | Vreg/256*109 | 2.051 | 2.129 | |
| 0 | 0 | 0 | 3 | 19 | Vreg/256*100 | Vreg/256*104 | 1.953 | 2.031 | |
| | | | | 18 | Vreg/256*95 | Vreg/256*99 | 1.855 | 1.934 | |
| 0 | 0 | 0 | 4 | 17 | Vreg/256*90 | Vreg/256*94 | 1.758 | 1.836 | |
| | | | | 16 | Vreg/256*85 | Vreg/256*89 | 1.66 | 1.738 | |
| 0 | 0 | 0 | 3 | 15 | Vreg/256*80 | Vreg/256*84 | 1.563 | 1.641 | |
| | | | | 14 | Vreg/256*75 | Vreg/256*79 | 1.465 | 1.543 | |
| 0 | 0 | 0 | 2 | 13 | Vreg/256*70 | Vreg/256*74 | 1.367 | 1.445 | |
| | | | | 12 | Vreg/256*65 | Vreg/256*69 | 1.27 | 1.348 | |
| 0 | 0 | 0 | 1 | 11 | Vreg/256*60 | Vreg/256*64 | 1.172 | 1.250 | |
| | | | | 10 | Vreg/256*55 | Vreg/256*59 | 1.074 | 1.152 | |
| 0 | 0 | 0 | 2 | 9 | Vreg/256*50 | Vreg/256*54 | 0.977 | 1.055 | |
| | | | | 8 | Vreg/256*45 | Vreg/256*49 | 0.879 | 0.957 | |
| 0 | 0 | 0 | 1 | 7 | Vreg/256*40 | Vreg/256*44 | 0.781 | 0.859 | |
| | | | | 6 | Vreg/256*35 | Vreg/256*39 | 0.684 | 0.762 | |
| 0 | 0 | 0 | 0 | 5 | Vreg/256*30 | Vreg/256*34 | 0.586 | 0.664 | |
| | | | | 4 | Vreg/256*25 | Vreg/256*29 | 0.488 | 0.566 | |
| 0 | 0 | 0 | 1 | 3 | Vreg/256*20 | Vreg/256*24 | 0.391 | 0.469 | |
| | | | | 2 | Vreg/256*15 | Vreg/256*19 | 0.293 | 0.371 | |
| 0 | 0 | 0 | 0 | 1 | Vreg/256*10 | Vreg/256*14 | 0.195 | 0.273 | |
| | | | | 0 | 0 | Vreg/256*9 | 0 | 0.176 | |

Functional Description

The equivalent circuit diagrams may be simplified or some parts of them maybe omitted for explanatory purposes. Timing charts may be simplified for explanatory purposes.

1. Basic Operation

During startup, the motor is driven by 120 degree commutation. After the position signal reaches a rotational speed of 1 Hz, the motor is driven by sine-wave drive as the rotor positions are estimated by the position signals.

- Startup to 1 Hz: 120 degree PWM drive
- 1 Hz to: Sine-wave PWM drive

2. Startup Operation

On duty at startup depends on setting MIN_SP terminal.

1) When MIN_SP = "1 to 7" (10.9% to 20.3%)

•If rotational speed command > MIN_SP

The output begins with on duty set at MIN_SP terminal.

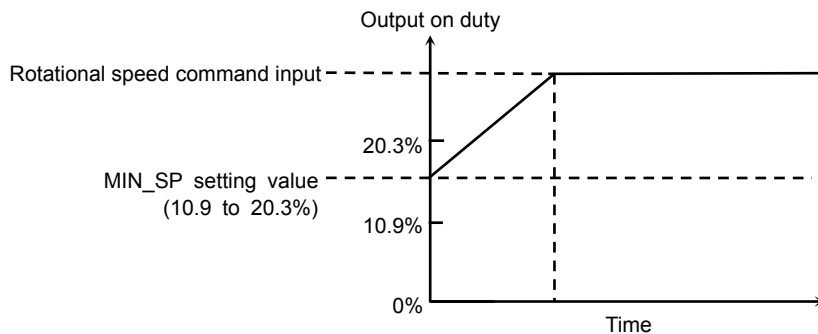

•If rotational speed command ≤ MIN_SP

The output begins with on duty set at MIN_SP terminal.

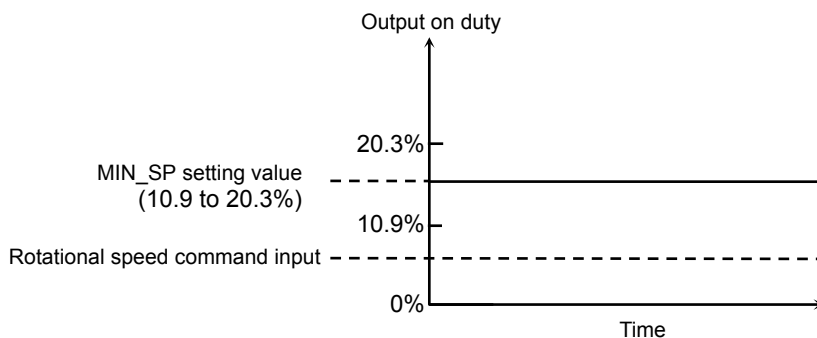

2) When MIN_SP = "8"

•If Rotational speed command > 20.3%

The output begins with 20.3% of on duty.

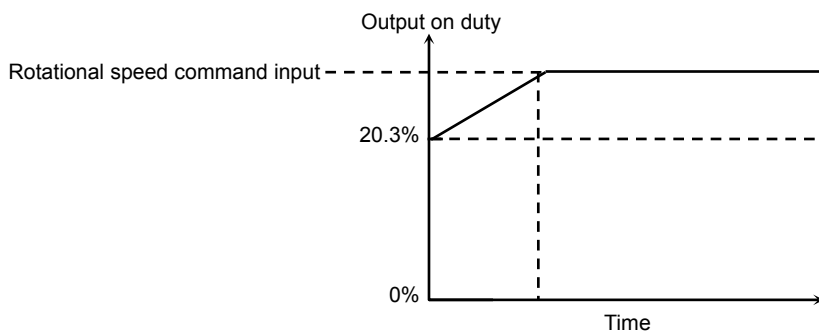

•If Rotational speed command $\leq 20.3\%$

The output begins with on duty of the rotational speed command input.

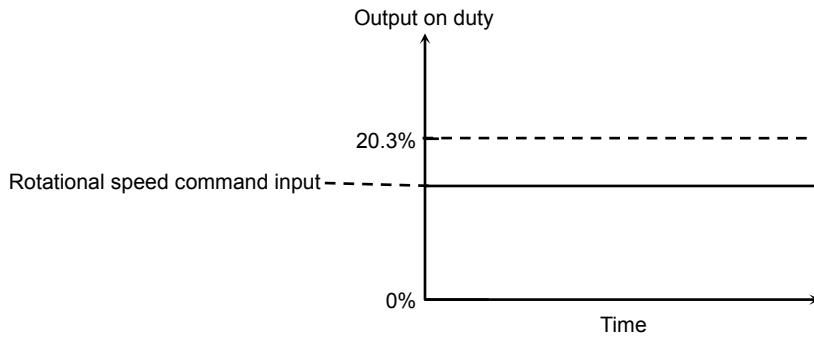

3) When MIN_SP = "0"

•If Rotational speed command $> 10.9\%$

The output begins with 10.9% of on duty.

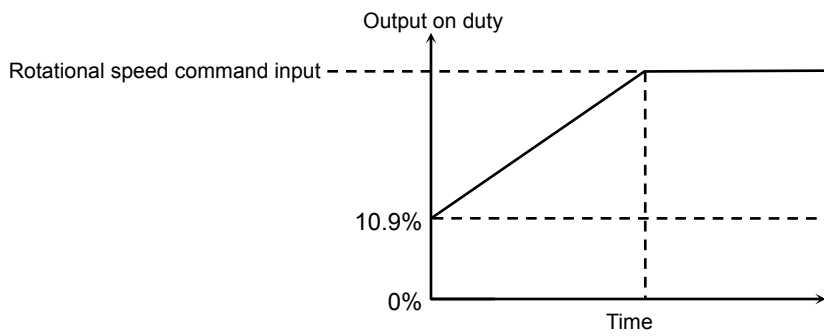

•If Rotational speed command $\leq 10.9\%$

The output begins with on duty of the rotational speed command input.

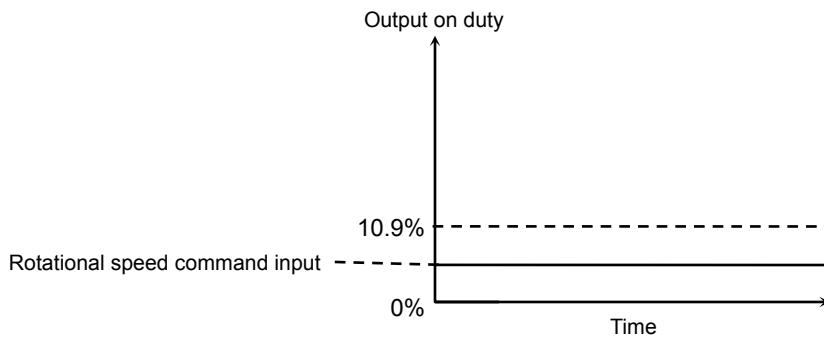

3. Position detection terminal

<Hall element input>

Common-mode input voltage range: $V_w = 0.5$ to 3.5 V

Input hysteresis: $V_H = 8$ mV (typ.)

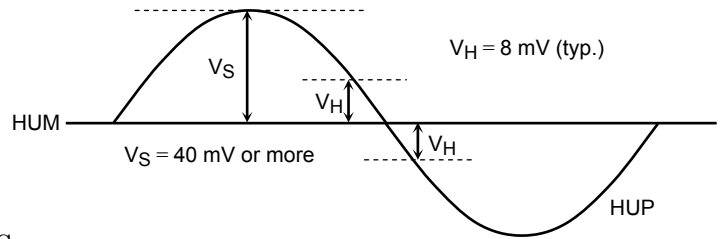

<Hall IC input>

Conditions: HUP, HVP, HWP = GND to VREG

HUM, HVM, HWM = VREG/2

4. Operation in abnormality detection

The following events are detected as abnormalities:

1. The ISD circuit is activated.
2. The TSD circuit is activated.
3. The motor lockout detection is activated.
4. Overvoltage detection is activated.

If the above abnormality either 1, 2 or 3 is detected, low level outputs at LD_OUT terminal until sine-wave drive starts.

5. Motor lockout detection

If the position signal does not change within the period of Ton after inputting a start command, the output signal for the drive is turned off, and moreover, both the drive during the period of Ton set at SEL_LD terminal and a non-drive during the period of Toff are repeated alternatively.

When on duty = 0% as a rotational speed command is input into TSP/VSP terminal, the period of Toff is released. After a start command signal is input into TSP/VSP terminal, the drive will restart.

Input a rotational speed command which is both 0% and 2ms period or more, when the abnormality detection is released.

Ton and Toff are set by SEL_LD terminal as follows.

| Number of steps set at SEL_LD terminal | Functional description |
|--|--|
| 3 | Motor lockout detection does not work. |
| 2 | Ton = 1 s (typ.), Toff = 10 s (typ.) |
| 1 | Ton = 0.5 s (typ.), Toff = 10 s (typ.) |
| 0 | Ton = 0.5 s (typ.), Toff = 5 s (typ.) |

6. Forward /Reverse rotation direction switching

CW/CCW = Low: Forward direction, CW/CCW = High: Reverse direction

| CW/CCW | Order of commutating phase of output |
|--------|--|
| L | Forward rotation direction: U→V→W→U→ . . . |
| H | Reverse rotation direction: W→V→U→W→ . . . |

7. Rotational speed output

A rotation pulse based upon hall signals is output.

Either 1 pulse or 3 pulses per electrical angle can be selected as a mode of FG_OUT terminal by the number of steps set at SEL_FG terminal.

| Number of steps set at SEL_FG terminal | FG_OUT |
|--|-------------------------------|
| 1 | 3 pulses per electrical angle |
| 0 | 1 pulse per electrical angle |

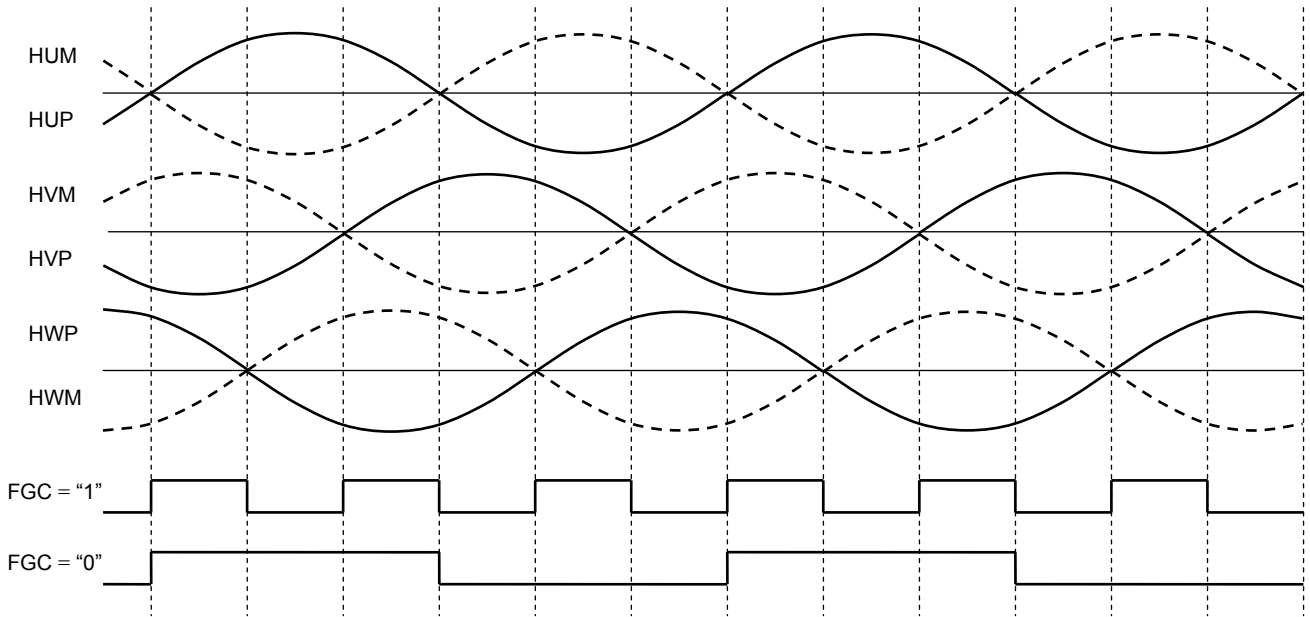

8. Rotational speed command

Startup, stop and motor rotational speed which is set by output PWM duty are able to be controlled by an input signal into TSP/VSP terminal.

Either an analog voltage control or a pulse duty control can be selected as a mode of TSP/VSP terminal by the number of steps set at SEL_SP terminal.

| Number of steps set at SEL_SP terminal | Input control at TSP/VSP terminal |
|--|-----------------------------------|
| 2 | Analog voltage control |
| 1 | Pulse duty control |
| 0 | Test mode |

1) When analog voltage control at TSP/VSP terminal (SEL_SP="2")

When the voltage at TSP/VSP terminal ≥ 0.625 V, startup sequence starts.
 When the voltage at TSP/VSP terminal < 0.625 V, the sequence is reset.

$0 \leq \text{VSP/TSP (when analog voltage control)} \leq \text{VAD (L)} : 0.625$ V (typ.)

→ Duty = 0%

$\text{VAD (L)} : 0.625$ V (typ.) $\leq \text{VSP/TSP (when analog voltage control)} \leq \text{VAD (H)} : 3.125$ V (typ.)

→ See the below figure. (1/128 to 128/128)

$\text{VAD (H)} 3.125$ V (typ.) $\leq \text{VSP/TSP (when analog voltage control)} \leq \text{VREG}$

→ Duty = 100% (128/128)

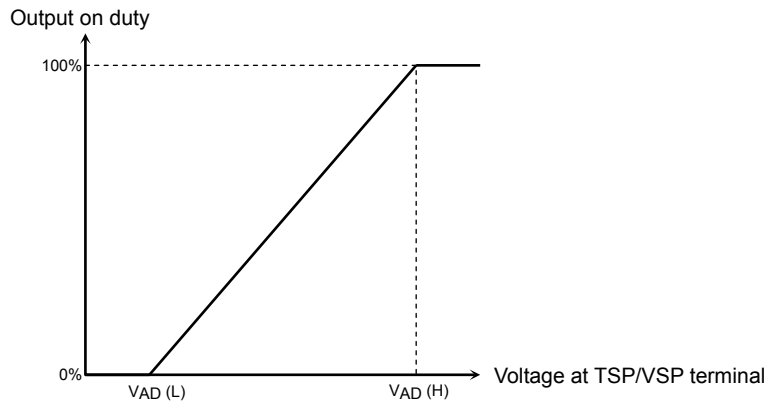

2) When pulse duty control at TSP/VSP terminal (SEL_SP="1")

When a PWM signal is input into TSP/VSP terminal, startup sequence starts.

The frequency of input pulse into TSP/VSP terminal should be set from 1 kHz to 100 kHz because 0.2 μ s or less of output on duty may be ineffective as an input signal or because the operation is judged as stopped state at output off duty = 1 ms or more.

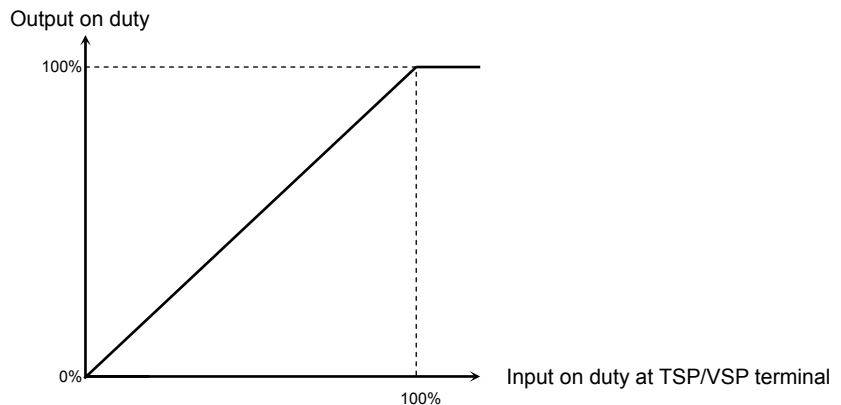

9. Setting minimum output on duty

Minimum output on duty depends on input voltage into MIN_SP terminal.

| Number of steps set at MIN_SP terminal | Minimum output duty | Duty during startup |
|--|---------------------|---|
| 8 | 0% | Rotational speed command value > 20.3%: 20.3% Rotational speed command value ≤ 20.3%: Rotational speed command value |
| 7 | 20.3% | 20.3% |
| 6 | 18.8% | 18.8% |
| 5 | 17.2% | 17.2% |
| 4 | 15.6% | 15.6% |
| 3 | 14.1% | 14.1% |
| 2 | 12.5% | 12.5% |
| 1 | 10.9% | 10.9% |
| 0 | 0% | Rotational speed command value > 10.9%: 10.9% Rotational speed command value ≤ 10.9%: Rotational speed command value |

10. PWM frequency

Output PWM frequency either in analog voltage control or in pulse duty control depends upon input voltage at FPWM terminal.

Output PWM frequency should be much higher than the electrical frequency of the motor and should be within switching performance of the drive circuits.

| Number of steps set at FPWM terminal | PWM frequency |
|--------------------------------------|---------------|
| 3 | 25 kHz |
| 2 | 200 kHz |
| 1 | 100 kHz |
| 0 | 50 kHz |

11. Lead angle control

Since the rotation speed changes due to motor impedance and others, a phase difference is generated between the motor voltage and current. Then, the motor driving efficiency is lowered. To improve its efficiency, the lead angle control is necessary to reduce this phase difference.

Lead angle control mode is determined by setting SEL_LA terminal.

| Number of steps set at SEL_LA terminal | Functional description |
|--|--|
| 2 | Auto lead angle: InPAC(Intelligent Phase Control) control Offset value selected by input voltage of LA terminal |
| 1 | Auto lead angle: Proportion to frequency Auto lead angle mode selected by input voltage of LA terminal |
| 0 | External input: Lead angle set by input voltage of LA terminal |

1) Auto lead angle control by InPAC (Intelligent Phase Control) architecture (SEL_LA="2")

In InPAC architecture, the phase of the motor current (current information) and the phase of the motor voltage (hall signal) are compared, and the result is fed back to the motor current control (control signal). And the phase difference of the motor voltage and current is adjusted automatically to achieve high efficient drive.

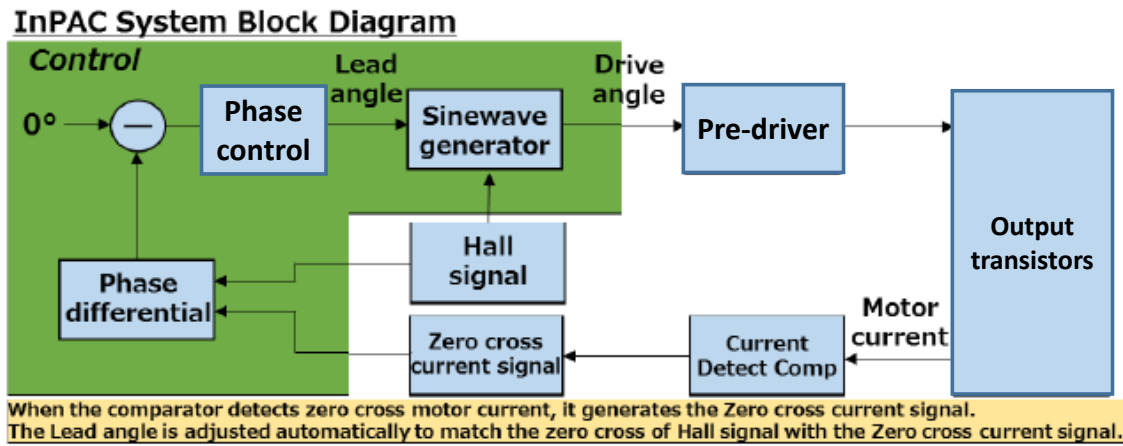

When the motor inductive voltage and the hall signal have a phase difference due to the mechanical shift of the hall sensor, the phase of the hall signal can be corrected in the range of -28.125° to 28.125° electrically by using the LA pin. Analog input of LA pin (Voltage range of 0 to 3.125 V is divided into 32.)

Relation of LA pin voltage and offset values is shown in the below table.

Under the conditions of CW/CCW = L and CW/CCW = H, offset values of positive and negative marks are reversed.

When CW/CCW = L

| Number of steps | LA [V] | Offset [deg] | Number of steps | LA [V] | Offset [deg] |
|-----------------|--------|--------------|-----------------|--------|--------------|
| 31 | 3.125 | -28.125 | 15 | 1.563 | 28.125 |
| 30 | 3.027 | -26.250 | 14 | 1.465 | 26.250 |
| 29 | 2.930 | -24.375 | 13 | 1.367 | 24.375 |
| 28 | 2.832 | -22.500 | 12 | 1.270 | 22.500 |
| 27 | 2.734 | -20.625 | 11 | 1.172 | 20.625 |
| 26 | 2.637 | -18.750 | 10 | 1.074 | 18.750 |
| 25 | 2.539 | -16.875 | 9 | 0.977 | 16.875 |
| 24 | 2.441 | -15.000 | 8 | 0.879 | 15.000 |
| 23 | 2.344 | -13.125 | 7 | 0.781 | 13.125 |
| 22 | 2.246 | -11.250 | 6 | 0.684 | 11.250 |
| 21 | 2.148 | -9.375 | 5 | 0.586 | 9.375 |
| 20 | 2.051 | -7.500 | 4 | 0.488 | 7.500 |
| 19 | 1.953 | -5.625 | 3 | 0.391 | 5.625 |
| 18 | 1.855 | -3.750 | 2 | 0.293 | 3.750 |
| 17 | 1.758 | -1.875 | 1 | 0.195 | 1.875 |
| 16 | 1.660 | 0 | 0 | 0 | 0 |

When CW/CCW = H

| Number of steps | LA [V] | Offset [deg] | Number of steps | LA [V] | Offset [deg] |
|-----------------|--------|--------------|-----------------|--------|--------------|
| 31 | 3.125 | 28.125 | 15 | 1.563 | -28.125 |
| 30 | 3.027 | 26.250 | 14 | 1.465 | -26.250 |
| 29 | 2.930 | 24.375 | 13 | 1.367 | -24.375 |
| 28 | 2.832 | 22.500 | 12 | 1.270 | -22.500 |
| 27 | 2.734 | 20.625 | 11 | 1.172 | -20.625 |
| 26 | 2.637 | 18.750 | 10 | 1.074 | -18.750 |
| 25 | 2.539 | 16.875 | 9 | 0.977 | -16.875 |
| 24 | 2.441 | 15.000 | 8 | 0.879 | -15.000 |
| 23 | 2.344 | 13.125 | 7 | 0.781 | -13.125 |
| 22 | 2.246 | 11.250 | 6 | 0.684 | -11.250 |
| 21 | 2.148 | 9.375 | 5 | 0.586 | -9.375 |
| 20 | 2.051 | 7.500 | 4 | 0.488 | -7.500 |
| 19 | 1.953 | 5.625 | 3 | 0.391 | -5.625 |
| 18 | 1.855 | 3.750 | 2 | 0.293 | -3.750 |
| 17 | 1.758 | 1.875 | 1 | 0.195 | -1.875 |
| 16 | 1.660 | 0 | 0 | 0 | 0 |

2)Auto lead angle (SEL_LA = "1")

The threshold of the frequency has hysteresis +0 Hz/-50 Hz.

Lead angle value [deg]

| Number of steps set at LA terminal | Electrical frequency [Hz] | | | | | | | | | |
|------------------------------------|---------------------------|------------|------------|------------|------------|------------|------------|------------|------------|-------------|
| | 0 to 100 | 100 to 200 | 200 to 300 | 300 to 400 | 400 to 500 | 500 to 600 | 600 to 700 | 700 to 800 | 800 to 900 | 900 to 1000 |
| 7 | 0 | 1.875 | 1.875 | 1.875 | 1.875 | 3.750 | 3.750 | 3.750 | 3.750 | 5.625 |
| 6 | 0 | 1.875 | 1.875 | 3.750 | 3.750 | 5.625 | 5.625 | 7.500 | 7.500 | 9.325 |
| 5 | 0 | 1.875 | 1.875 | 3.750 | 5.625 | 7.500 | 7.500 | 9.325 | 11.250 | 13.125 |
| 4 | 0 | 1.875 | 3.750 | 5.625 | 9.325 | 11.250 | 13.125 | 15.000 | 18.750 | 20.625 |
| 3 | 0 | 1.875 | 5.625 | 7.500 | 11.250 | 13.125 | 16.875 | 18.750 | 22.500 | 24.375 |
| 2 | 0 | 3.750 | 5.625 | 9.325 | 13.125 | 16.875 | 18.750 | 22.500 | 26.250 | 30.000 |
| 1 | 0 | 3.750 | 7.500 | 11.250 | 15.000 | 18.750 | 22.500 | 26.250 | 30.000 | 33.750 |
| 0 | 0 | 1.875 | 3.750 | 5.625 | 7.500 | 9.325 | 11.250 | 13.125 | 15.000 | 16.875 |

Lead angle value [deg]

| Number of steps set at LA terminal | Electrical frequency [Hz] | | | | | | | | | | |
|------------------------------------|---------------------------|--------------|--------------|--------------|--------------|--------------|--------------|--------------|--------------|--------------|----------------|
| | 1000 to 1100 | 1100 to 1200 | 1200 to 1300 | 1300 to 1400 | 1400 to 1500 | 1500 to 1600 | 1600 to 1700 | 1700 to 1800 | 1800 to 1900 | 1900 to 2000 | More than 2000 |
| 7 | 5.625 | 5.625 | 5.625 | 7.500 | 7.500 | 7.500 | 7.500 | 9.375 | 9.375 | 9.375 | 9.375 |
| 6 | 9.325 | 11.250 | 11.250 | 13.125 | 13.125 | 15.000 | 15.000 | 16.875 | 16.875 | 18.750 | 18.750 |
| 5 | 13.125 | 15.000 | 16.875 | 18.750 | 18.750 | 20.625 | 22.500 | 24.375 | 24.375 | 26.250 | 28.125 |
| 4 | 22.500 | 24.375 | 28.125 | 30.000 | 31.875 | 33.750 | 37.500 | 39.375 | 41.250 | 43.125 | 46.875 |
| 3 | 28.125 | 30.000 | 33.750 | 35.625 | 39.375 | 41.250 | 45.000 | 46.875 | 50.625 | 52.500 | 56.250 |
| 2 | 31.875 | 35.625 | 39.375 | 43.125 | 45.000 | 48.750 | 52.500 | 56.250 | 58.125 | 58.125 | 58.125 |
| 1 | 37.500 | 41.250 | 45.000 | 48.750 | 52.500 | 56.250 | 56.250 | 56.250 | 56.250 | 56.250 | 56.250 |
| 0 | 18.750 | 20.625 | 22.500 | 24.375 | 26.250 | 28.125 | 30.000 | 31.875 | 33.750 | 35.625 | 37.500 |

3) External input (SEL_LA = "0")

Lead angle in the range of 0° to 58.125° as commutation signals which correspond to the induced voltage can be adjusted.

The range from 0 V to 3.125 V as analog input voltage into LA terminal is divided into 32 parts.

When input voltage into LA terminal = 0 V, lead angle = 0°.

When input voltage into LA terminal = 3.125 V, lead angle = 58.125°.

When input voltage into LA terminal \geq 3.125 V, lead angle = 58.125°.

(Design value)

| Number of steps | LA [V] | Lead angle [deg] | Number of steps | LA [V] | Lead angle [deg] |
|-----------------|--------|------------------|-----------------|--------|------------------|
| 31 | 3.125 | 58.125 | 15 | 1.563 | 28.125 |
| 30 | 3.027 | 56.250 | 14 | 1.465 | 26.250 |
| 29 | 2.930 | 54.375 | 13 | 1.367 | 24.375 |
| 28 | 2.832 | 52.500 | 12 | 1.270 | 22.500 |
| 27 | 2.734 | 50.625 | 11 | 1.172 | 20.625 |
| 26 | 2.637 | 48.750 | 10 | 1.074 | 18.750 |
| 25 | 2.539 | 46.875 | 9 | 0.977 | 16.875 |
| 24 | 2.441 | 45.000 | 8 | 0.879 | 15.000 |
| 23 | 2.344 | 43.125 | 7 | 0.781 | 13.125 |
| 22 | 2.246 | 41.250 | 6 | 0.684 | 11.250 |
| 21 | 2.148 | 39.375 | 5 | 0.586 | 9.375 |
| 20 | 2.051 | 37.500 | 4 | 0.488 | 7.500 |
| 19 | 1.953 | 35.625 | 3 | 0.391 | 5.625 |
| 18 | 1.855 | 33.750 | 2 | 0.293 | 3.750 |
| 17 | 1.758 | 31.875 | 1 | 0.195 | 1.875 |
| 16 | 1.660 | 30.000 | 0 | 0.000 | 0.000 |

4) Auto lead angle (SEL_LA="2")

Offset of Hall signal in the range of -28° to 28° can be adjusted.

The range from 0V to 3.125V as analog input voltage into LA terminal is divided into 32 parts.

Plus sign and minus sign are reversed between CW/CCW = L and CW/CCW = H.

When CW/CCW = L

| Number of steps | LA [V] | Offset [deg] | Number of steps | LA [V] | Offset [deg] |
|-----------------|--------|--------------|-----------------|--------|--------------|
| 31 | 3.125 | -28.125 | 15 | 1.563 | 28.125 |
| 30 | 3.027 | -26.250 | 14 | 1.465 | 26.250 |
| 29 | 2.930 | -24.375 | 13 | 1.367 | 24.375 |
| 28 | 2.832 | -22.500 | 12 | 1.270 | 22.500 |
| 27 | 2.734 | -20.625 | 11 | 1.172 | 20.625 |
| 26 | 2.637 | -18.750 | 10 | 1.074 | 18.750 |
| 25 | 2.539 | -16.875 | 9 | 0.977 | 16.875 |
| 24 | 2.441 | -15.000 | 8 | 0.879 | 15.000 |
| 23 | 2.344 | -13.125 | 7 | 0.781 | 13.125 |
| 22 | 2.246 | -11.250 | 6 | 0.684 | 11.250 |
| 21 | 2.148 | -9.375 | 5 | 0.586 | 9.375 |
| 20 | 2.051 | -7.500 | 4 | 0.488 | 7.500 |
| 19 | 1.953 | -5.625 | 3 | 0.391 | 5.625 |
| 18 | 1.855 | -3.750 | 2 | 0.293 | 3.750 |
| 17 | 1.758 | -1.875 | 1 | 0.195 | 1.875 |
| 16 | 1.660 | 0 | 0 | 0 | 0 |

When CW/CCW = H

| Number of steps | LA [V] | Offset [deg] | Number of steps | LA [V] | Offset [deg] |
|-----------------|--------|--------------|-----------------|--------|--------------|
| 31 | 3.125 | 28.125 | 15 | 1.563 | -28.125 |
| 30 | 3.027 | 26.250 | 14 | 1.465 | -26.250 |
| 29 | 2.930 | 24.375 | 13 | 1.367 | -24.375 |
| 28 | 2.832 | 22.500 | 12 | 1.270 | -22.500 |
| 27 | 2.734 | 20.625 | 11 | 1.172 | -20.625 |
| 26 | 2.637 | 18.750 | 10 | 1.074 | -18.750 |
| 25 | 2.539 | 16.875 | 9 | 0.977 | -16.875 |
| 24 | 2.441 | 15.000 | 8 | 0.879 | -15.000 |
| 23 | 2.344 | 13.125 | 7 | 0.781 | -13.125 |
| 22 | 2.246 | 11.250 | 6 | 0.684 | -11.250 |
| 21 | 2.148 | 9.375 | 5 | 0.586 | -9.375 |
| 20 | 2.051 | 7.500 | 4 | 0.488 | -7.500 |
| 19 | 1.953 | 5.625 | 3 | 0.391 | -5.625 |
| 18 | 1.855 | 3.750 | 2 | 0.293 | -3.750 |
| 17 | 1.758 | 1.875 | 1 | 0.195 | -1.875 |
| 16 | 1.660 | 0 | 0 | 0 | 0 |

12. Acceleration and deceleration control setting

When a capacitor is connected to TSTEP terminal, time to the reflection in the output duty can be set during acceleration and deceleration of the duty of the input control signal into TSP/VSP terminal. (About 0.078%/T) And the motor can accelerate and slow down gradually in starting. If the speed command that output ON duty is set 0% is inputted during operation, the decay function becomes invalid and the output is turned off. However, when variation of the duty of an input control signal is 2.5% or less, it is reflected in output duty for every PWM cycle.

Acceleration and deceleration time: (For example) When $C = 0.01 \mu\text{F}$, $32 \times T = 32 \times 0.313 \times C \times 10^6 = \text{about } 0.100 \text{ s}$.

When the speed command that the output on duty is 0% is inputted during operation, the deceleration function becomes invalid, and the output is turned off.

At this time, an output duty is reset to 0%. When restarting, please input a start command signal to TSP/VSP pin after inputting a speed control command that the output on duty is 0% for 2 ms or more.

In case of 7.5% increase in input DUTY

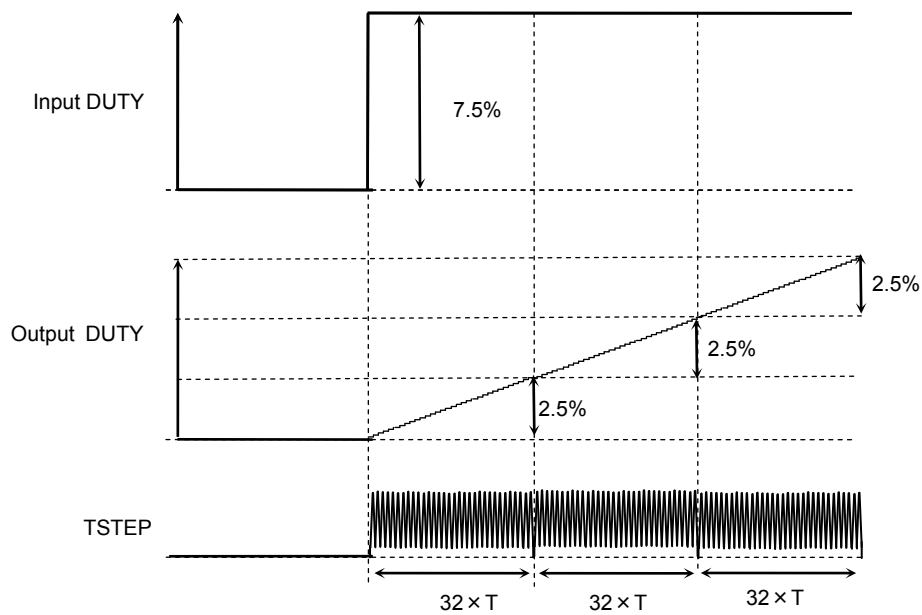

In case of 7.5% decrease in input DUTY

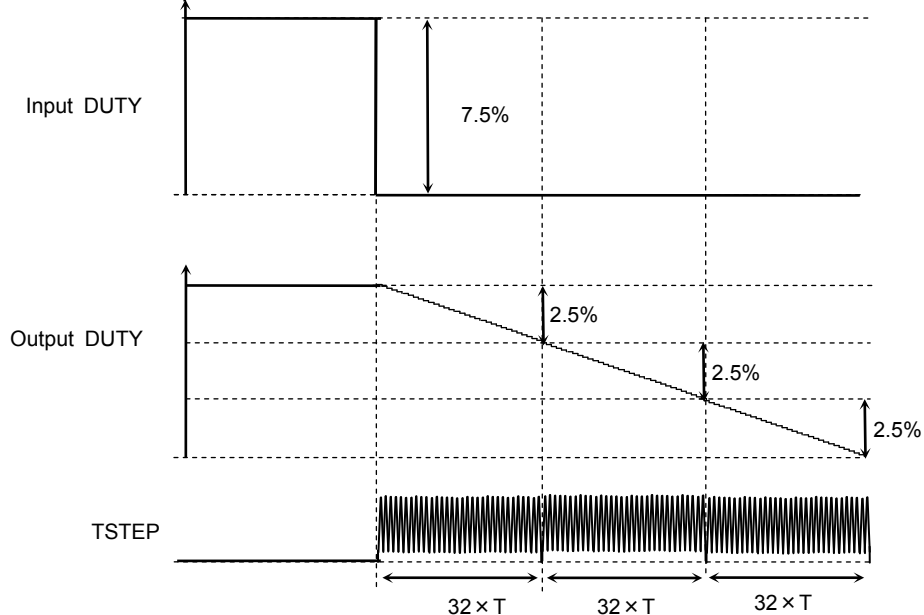

13. Brake function

If high level is input into BRAKE terminal, the reverse brake works, which can make a motor stop.

After the input signal into BRAKE terminal is changed from L level to H level during the motor rotation, the reverse brake works until the position signal frequency is 40 Hz. After the position signal frequency is less than 40 Hz, a motor will stop.

However, when the input signal into BRAKE terminal is changed from L level to H level during the output duty command = 0% at TSP/VSP terminal, the operation sequence is shown as the below table.

| BRAKE | Functional description |
|-------------|------------------------|
| High | Brake |
| Low or open | Normal operation |

When the input signal into BRAKE terminal is changed from L level to H level during the output duty command = 0% at TSP/VSP terminal

| Status | Brake sequence |
|----------------------------------|-----------------------------|
| Position signal frequency ≤ 40Hz | Short brake |
| Position signal frequency > 40Hz | Reverse brake → Short brake |

14. Overvoltage monitoring function

When MVM = 2.0 V (typ.) or more, drive mode is 120 degree commutation.

MVM has 0.2 V (typ.) of hysteresis. If MVM < 1.8 V (typ.), drive restarts.

| MVM | Functional description |
|--------------------|---|
| MVM > 2.0 V (typ.) | 120 degree commutation |
| MVM < 1.8 V (typ.) | Sine-wave PWM drive When SEL_LA = "2", lead angle = 0 degree. When SEL_LA = "1" or "0", lead angle is the value which is set. |

15. Current limit circuit

Current limit circuit turns off upper side output transistors and limits the current. Driver restarts just when PWM turns on. If output current flows, the current is detected by resistor R1. Then, after overcurrent sensing voltage reaches $V_{RS} = 0.25\text{ V}$, circuits begins to work.

Current value I_{OUT} which makes current limit circuit operate

$$= \text{Overcurrent sensing voltage } V_{RS} / \text{Sensing resistor } R_1$$

There is $1.2\ \mu\text{s}$ of mask time so as to prevent a malfunction by noise.

(For example) When $0.3\ \Omega$ is set as the resistor R_1 , $I_{OUT} (\text{typ.}) = 0.25\text{ V} (\text{typ.}) / 0.3\ \Omega \approx 0.83\text{ A}$.

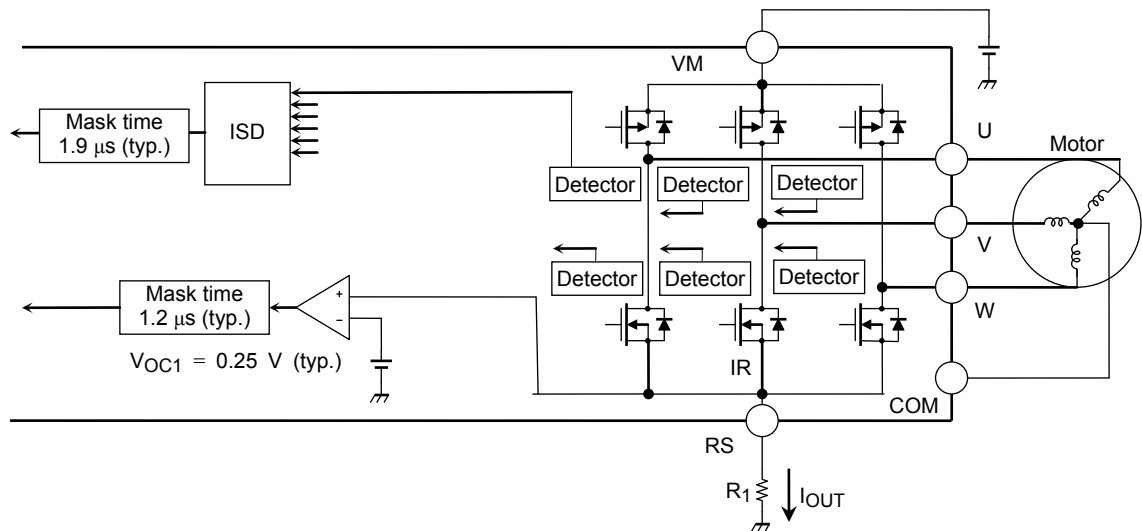

16. Overcurrent detection circuit (ISD)

Each of 6 overcurrent detector are built in each output transistor. If detected value exceeds the absolute maximum rating, all of outputs are turned off (high impedance: Hi-Z).

If output on duty of rotational speed command is set at 0%, abnormality detection is released.

Input a rotational speed command which is both 0% and 2 ms period or more, when the abnormality detection is released.

17. Thermal shutdown circuit (TSD)

Built-in thermal shutdown circuit makes outputs turn off (high impedance: Hi-Z), when the junction temperature (T_j) exceeds 165°C (typ.). There is 15°C (typ.) of hysteresis.

Temperature for restart is $T_{SD} - T_{SDhys}$ after thermal shutdown circuit operates.

$$T_{SD} = 165^\circ\text{C} (\text{typ.}), T_{SDhys} = 15^\circ\text{C} (\text{typ.})$$

18. Under voltage lockout (UVLO)

Built-in under voltage lockout makes each output of U, V, W, FG_OUT and LD_OUT turn off (high impedance: Hi-Z), when $VM = 5.3\text{ V}$ (typ.) or less. There is 0.3V (typ.) of hysteresis. Voltage for restart is 5.6 V (typ.) .

Timing diagram: sine-wave PWM drive

(CW/CCW = Low, lead angle = 0 degree, Positive Hall input ≥ 1 Hz)

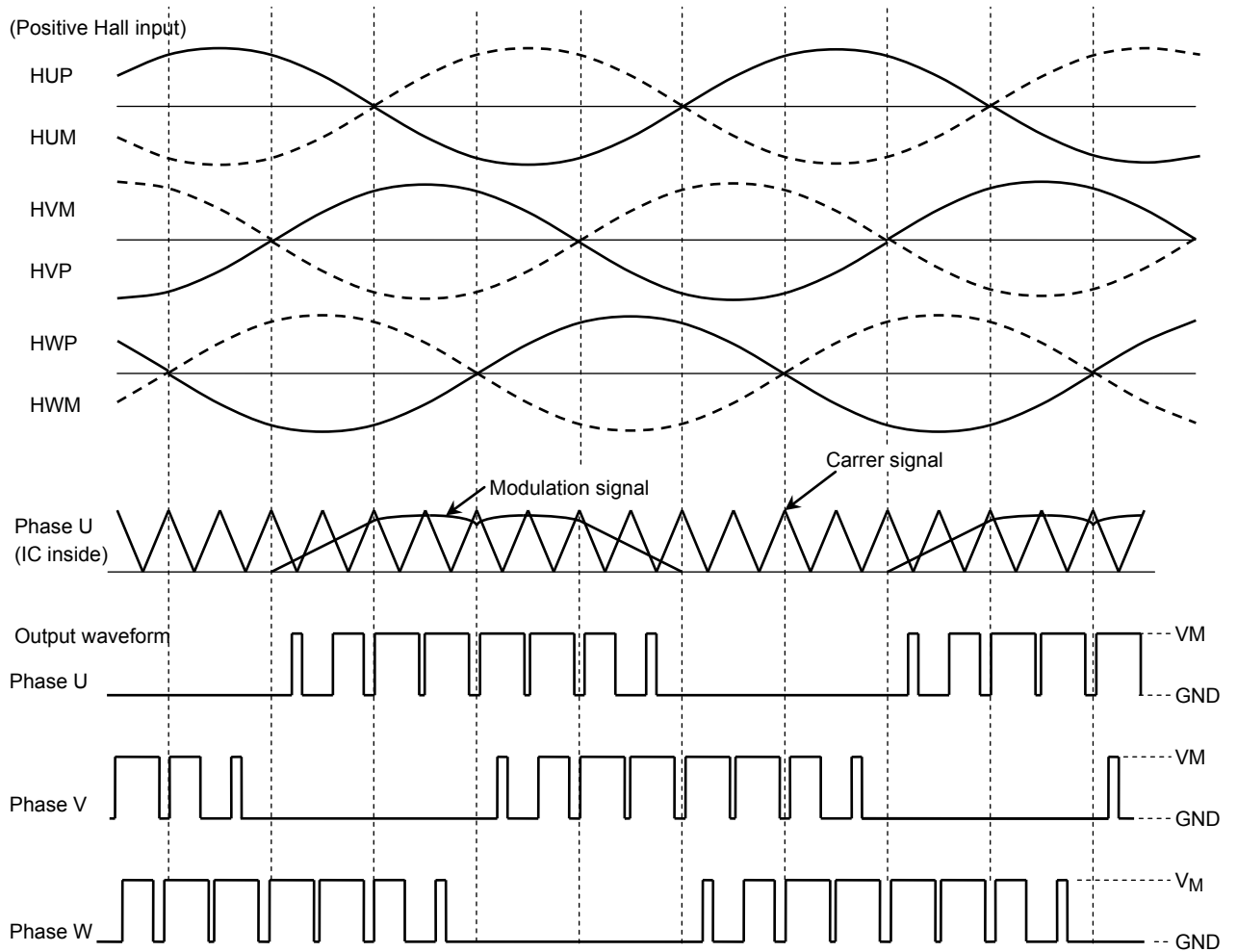

Note: Timing charts may be simplified for explanatory purposes.

Timing diagram: sine-wave PWM drive
 (CW/CCW = High, lead angle: 0 degree, Opposite Hall input)

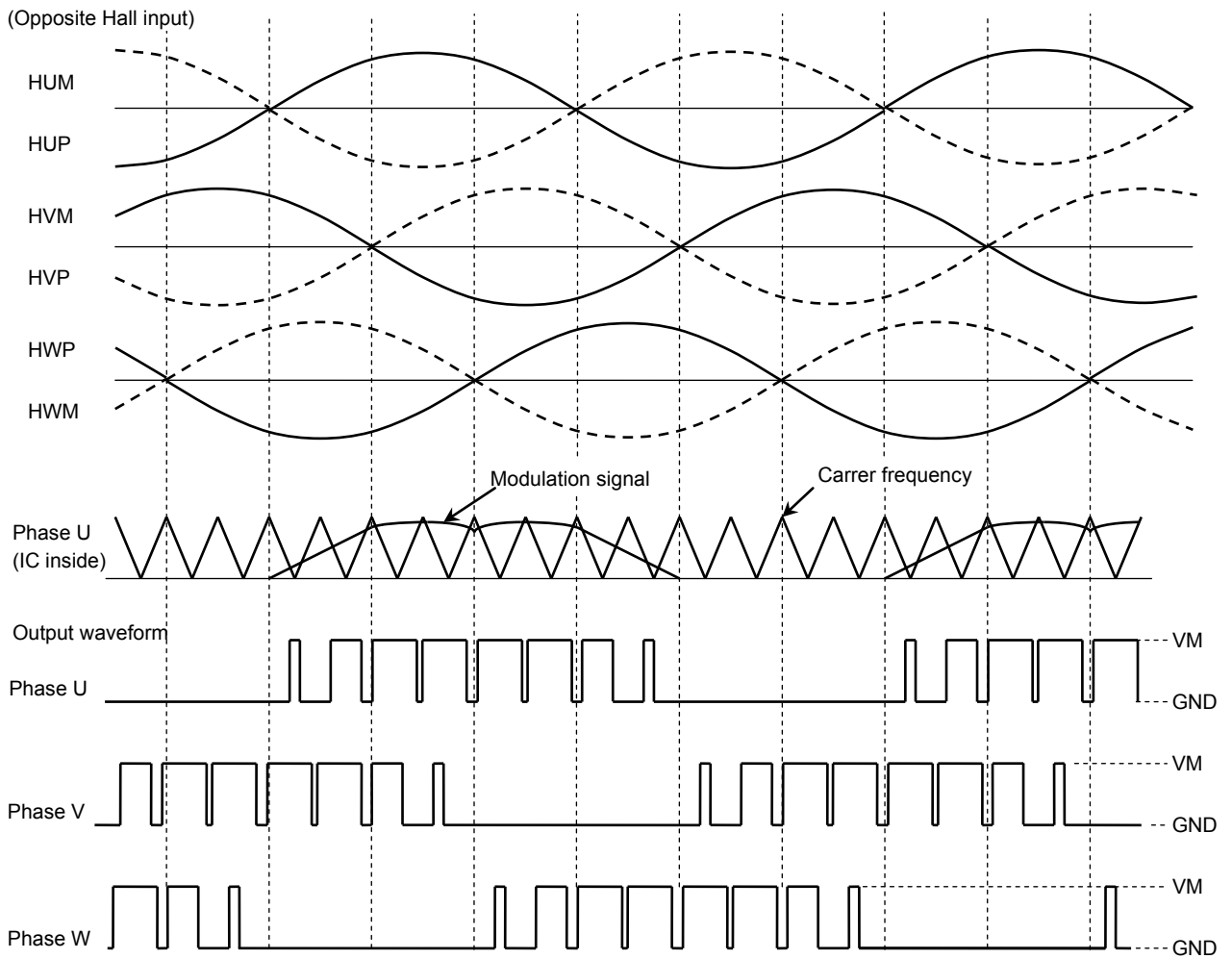

Note: Timing charts may be simplified for explanatory purposes.

Timing diagram: 120degree PWM drive

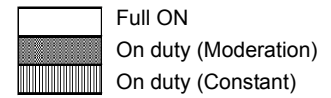

(1) CW/CCW = L

120 degree: Position signal(forward direction) $\leq 1\text{Hz}$, when MVM terminal voltage $> 2.0\text{ V}$ (typ.) [If MVM terminal voltage $< 1.8\text{ V}$ (typ.), sine-wave drive restarts.]

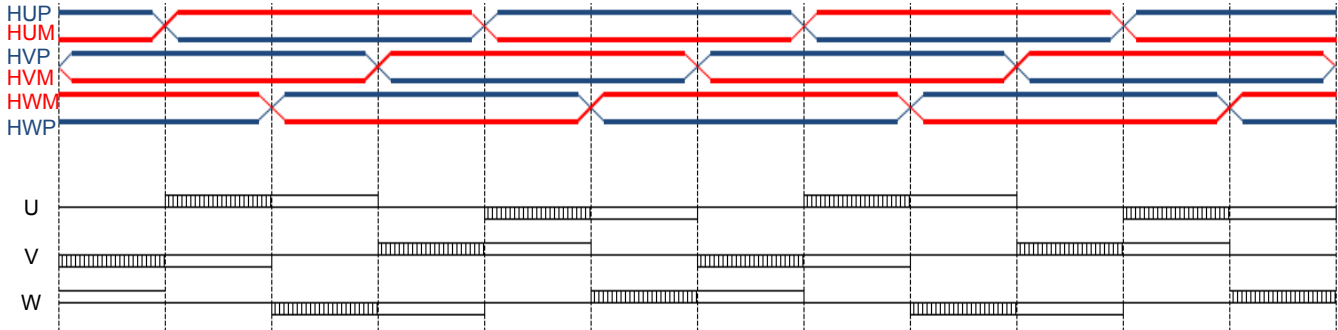

120 degree: Position signal is in reverse direction.

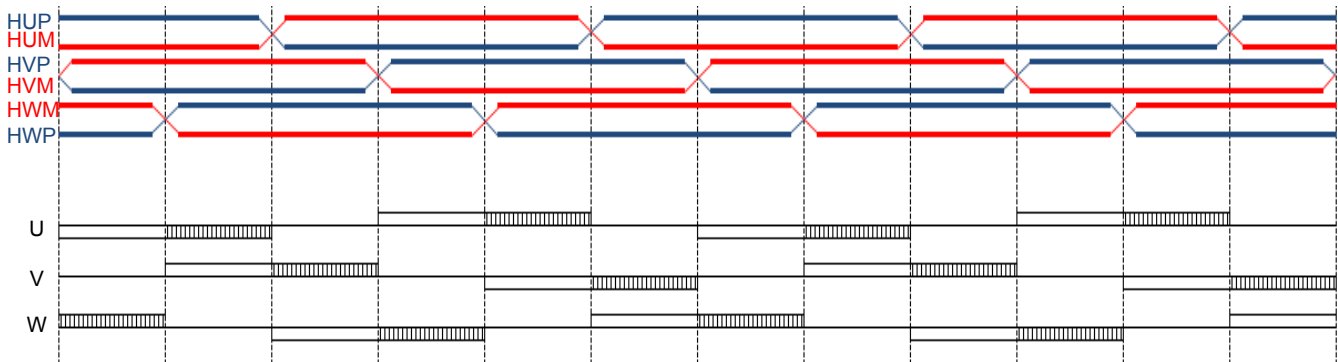

(2) CW/CCW = H

120 degree: Position signal (reverse direction) $\leq 1\text{ Hz}$, when MVM terminal voltage $> 2.0\text{ V}$ (typ.) [If MVM terminal voltage $< 1.8\text{ V}$ (typ.), sine-wave drive restarts.]

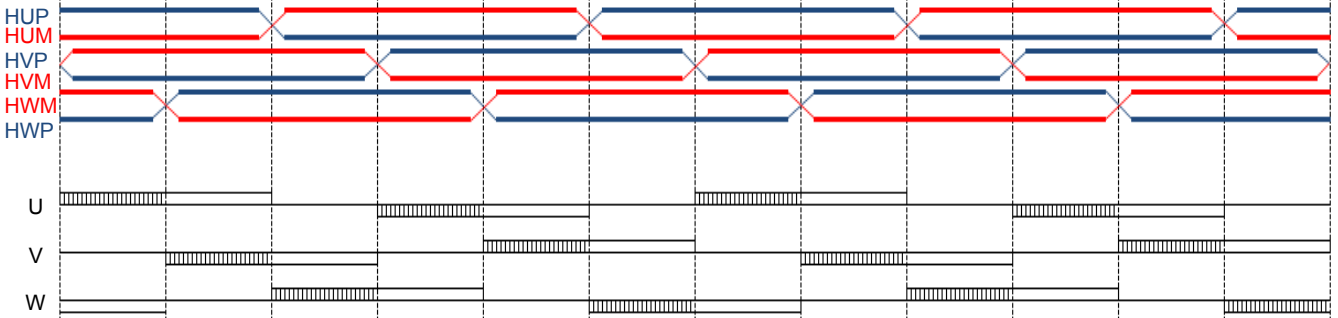

120 degree: Position signal is in forward direction.

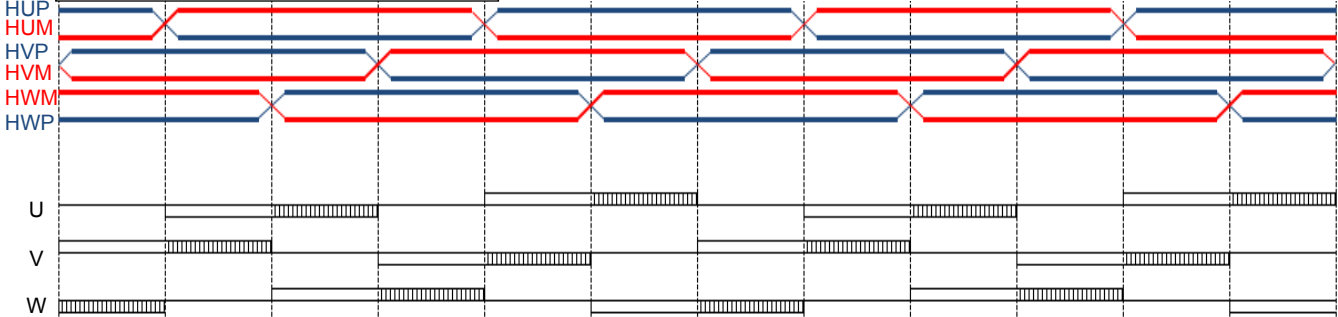

Application circuit example

Some of the functional blocks, circuits, or constants in the block diagram may be omitted or simplified for explanatory purposes. The application circuits shown in this document are provided for reference purposes only.

Thorough evaluation is required, especially at the mass production design stage.

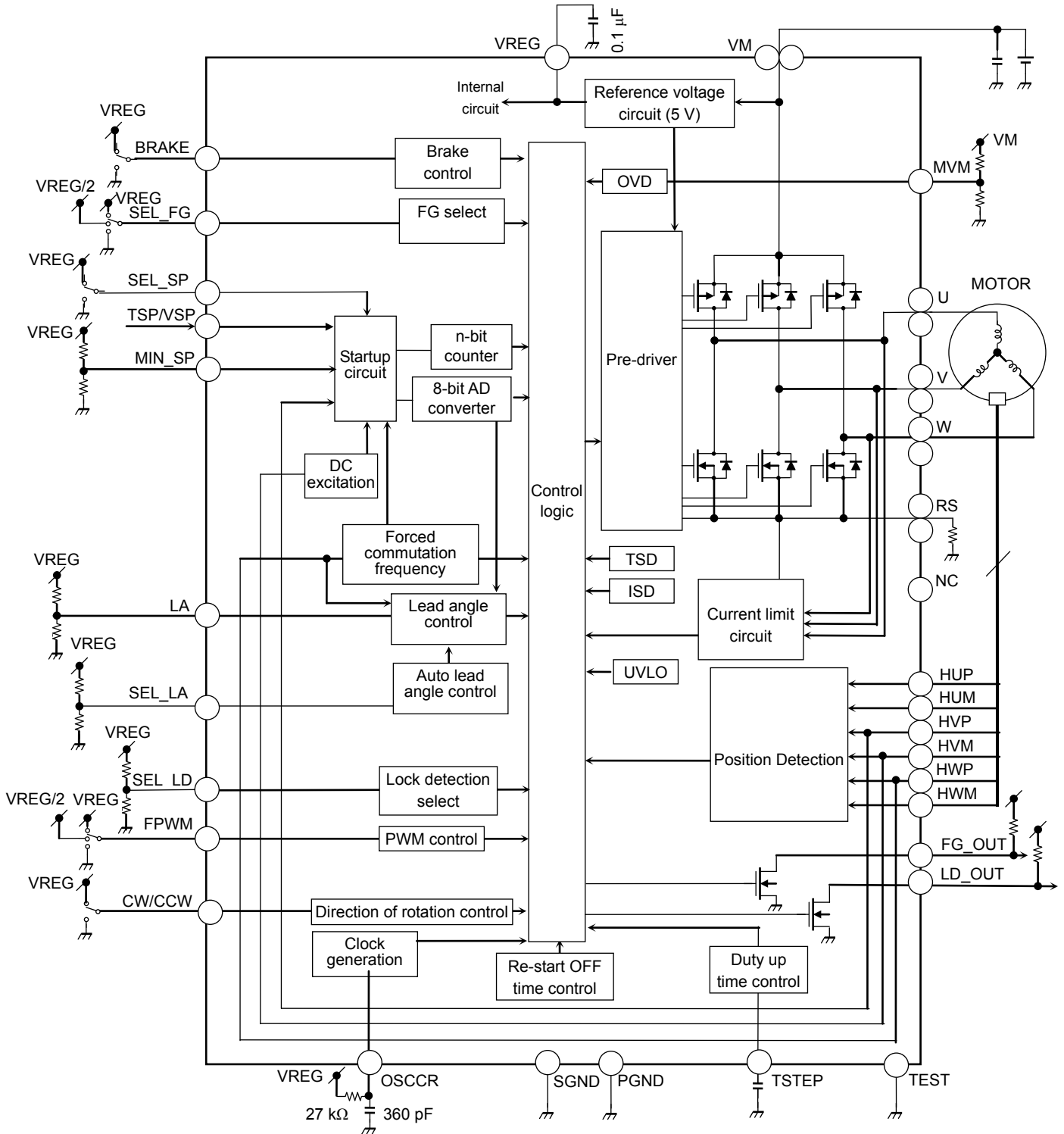

Package Dimensions

P-WQFN36-0505-0.50-001

Unit: mm

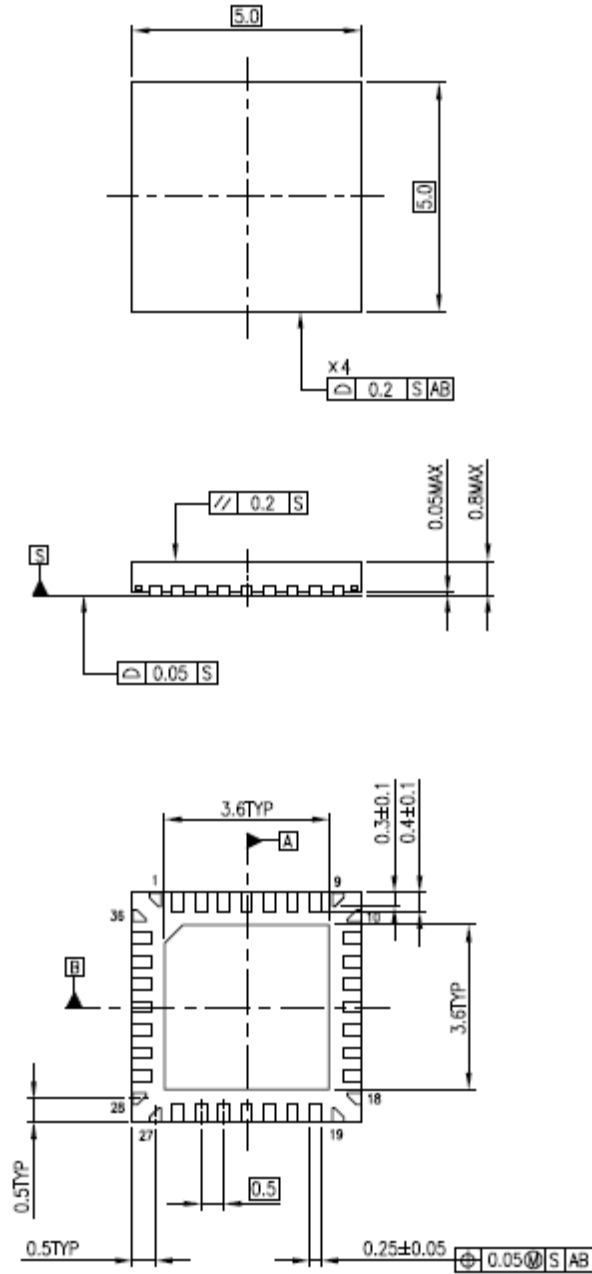

Weight: 0.06 g (typ.)

Notes on Contents

1. Block Diagrams

Some of the functional blocks, circuits, or constants in the block diagram may be omitted or simplified for explanatory purposes.

2. Equivalent Circuits

The equivalent circuit diagrams may be simplified or some parts of them may be omitted for explanatory purposes.

3. Timing Charts

Timing charts may be simplified for explanatory purposes.

4. Application Circuits

The application circuits shown in this document are provided for reference purposes only. Thorough evaluation is required, especially at the mass production design stage. Providing these application circuit examples does not grant a license for industrial property rights.

5. Test Circuits

Components in the test circuits are used only to obtain and confirm the device characteristics. These components and circuits are not guaranteed to prevent malfunction or failure from occurring in the application equipment.

IC Usage Considerations

Notes on handling of ICs

- (1) The absolute maximum ratings of a semiconductor device are a set of ratings that must not be exceeded, even for a moment. Do not exceed any of these ratings.
Exceeding the rating(s) may cause the device breakdown, damage or deterioration, and may result in injury by explosion or combustion.
- (2) Use an appropriate power supply fuse to ensure that a large current does not continuously flow in case of over current and/or IC failure. The IC will fully break down when used under conditions that exceed its absolute maximum ratings, when the wiring is routed improperly or when an abnormal pulse noise occurs from the wiring or load, causing a large current to continuously flow and the breakdown can lead to smoke or ignition. To minimize the effects of the flow of a large current in case of breakdown, appropriate settings, such as fuse capacity, fusing time and insertion circuit location, are required.
- (3) If your design includes an inductive load such as a motor coil, incorporate a protection circuit into the design to prevent device malfunction or breakdown caused by the current resulting from the inrush current at power ON or the negative current resulting from the back electromotive force at power OFF. IC breakdown may cause injury, smoke or ignition. Use a stable power supply with ICs with built-in protection functions. If the power supply is unstable, the protection function may not operate, causing IC breakdown. IC breakdown may cause injury, smoke or ignition.
- (4) Do not insert devices in the wrong orientation or incorrectly. Make sure that the positive and negative terminals of power supplies are connected properly. Otherwise, the current or power consumption may exceed the absolute maximum rating, and exceeding the rating(s) may cause the device breakdown, damage or deterioration, and may result in injury by explosion or combustion. In addition, do not use any device that is applied the current with inserting in the wrong orientation or incorrectly even just one time.

Points to remember on handling of ICs

(1) Over current Protection Circuit

Over current protection circuits (referred to as current limiter circuits) do not necessarily protect ICs under all circumstances. If the Over current protection circuits operate against the over current, clear the over current status immediately. Depending on the method of use and usage conditions, such as exceeding absolute maximum ratings can cause the over current protection circuit to not operate properly or IC breakdown before operation. In addition, depending on the method of use and usage conditions, if over current continues to flow for a long time after operation, the IC may generate heat resulting in breakdown.

(2) Thermal Shutdown Circuit

Thermal shutdown circuits do not necessarily protect ICs under all circumstances. If the thermal shutdown circuits operate against the over temperature, clear the heat generation status immediately. Depending on the method of use and usage conditions, such as exceeding absolute maximum ratings can cause the thermal shutdown circuit to not operate properly or IC breakdown before operation.

(3) Heat Radiation Design

In using an IC with large current flow such as power amp, regulator or driver, please design the device so that heat is appropriately radiated, not to exceed the specified junction temperature (T_j) at any time and condition. These ICs generate heat even during normal use. An inadequate IC heat radiation design can lead to decrease in IC life, deterioration of IC characteristics or IC breakdown. In addition, please design the device taking into consideration the effect of IC heat radiation with peripheral components.

(4) Back-EMF

When a motor rotates in the reverse direction, stops or slows down abruptly, a current flow back to the motor's power supply due to the effect of back-EMF. If the current sink capability of the power supply is small, the device's motor power supply and output pins might be exposed to conditions beyond absolute maximum ratings. To avoid this problem, take the effect of back-EMF into consideration in system design.

RESTRICTIONS ON PRODUCT USE

Toshiba Corporation and its subsidiaries and affiliates are collectively referred to as "TOSHIBA". Hardware, software and systems described in this document are collectively referred to as "Product".

- TOSHIBA reserves the right to make changes to the information in this document and related Product without notice.
- This document and any information herein may not be reproduced without prior written permission from TOSHIBA. Even with TOSHIBA's written permission, reproduction is permissible only if reproduction is without alteration/omission.
- Though TOSHIBA works continually to improve Product's quality and reliability, Product can malfunction or fail. Customers are responsible for complying with safety standards and for providing adequate designs and safeguards for their hardware, software and systems which minimize risk and avoid situations in which a malfunction or failure of Product could cause loss of human life, bodily injury or damage to property, including data loss or corruption. Before customers use the Product, create designs including the Product, or incorporate the Product into their own applications, customers must also refer to and comply with (a) the latest versions of all relevant TOSHIBA information, including without limitation, this document, the specifications, the data sheets and application notes for Product and the precautions and conditions set forth in the "TOSHIBA Semiconductor Reliability Handbook" and (b) the instructions for the application with which the Product will be used with or for. Customers are solely responsible for all aspects of their own product design or applications, including but not limited to (a) determining the appropriateness of the use of this Product in such design or applications; (b) evaluating and determining the applicability of any information contained in this document, or in charts, diagrams, programs, algorithms, sample application circuits, or any other referenced documents; and (c) validating all operating parameters for such designs and applications. **TOSHIBA ASSUMES NO LIABILITY FOR CUSTOMERS' PRODUCT DESIGN OR APPLICATIONS.**
- **PRODUCT IS NEITHER INTENDED NOR WARRANTED FOR USE IN EQUIPMENTS OR SYSTEMS THAT REQUIRE EXTRAORDINARILY HIGH LEVELS OF QUALITY AND/OR RELIABILITY, AND/OR A MALFUNCTION OR FAILURE OF WHICH MAY CAUSE LOSS OF HUMAN LIFE, BODILY INJURY, SERIOUS PROPERTY DAMAGE AND/OR SERIOUS PUBLIC IMPACT ("UNINTENDED USE").** Except for specific applications as expressly stated in this document, Unintended Use includes, without limitation, equipment used in nuclear facilities, equipment used in the aerospace industry, medical equipment, equipment used for automobiles, trains, ships and other transportation, traffic signaling equipment, equipment used to control combustions or explosions, safety devices, elevators and escalators, devices related to electric power, and equipment used in finance-related fields. **IF YOU USE PRODUCT FOR UNINTENDED USE, TOSHIBA ASSUMES NO LIABILITY FOR PRODUCT.** For details, please contact your TOSHIBA sales representative.
- Do not disassemble, analyze, reverse-engineer, alter, modify, translate or copy Product, whether in whole or in part.
- Product shall not be used for or incorporated into any products or systems whose manufacture, use, or sale is prohibited under any applicable laws or regulations.
- The information contained herein is presented only as guidance for Product use. No responsibility is assumed by TOSHIBA for any infringement of patents or any other intellectual property rights of third parties that may result from the use of Product. No license to any intellectual property right is granted by this document, whether express or implied, by estoppel or otherwise.
- **ABSENT A WRITTEN SIGNED AGREEMENT, EXCEPT AS PROVIDED IN THE RELEVANT TERMS AND CONDITIONS OF SALE FOR PRODUCT, AND TO THE MAXIMUM EXTENT ALLOWABLE BY LAW, TOSHIBA (1) ASSUMES NO LIABILITY WHATSOEVER, INCLUDING WITHOUT LIMITATION, INDIRECT, CONSEQUENTIAL, SPECIAL, OR INCIDENTAL DAMAGES OR LOSS, INCLUDING WITHOUT LIMITATION, LOSS OF PROFITS, LOSS OF OPPORTUNITIES, BUSINESS INTERRUPTION AND LOSS OF DATA, AND (2) DISCLAIMS ANY AND ALL EXPRESS OR IMPLIED WARRANTIES AND CONDITIONS RELATED TO SALE, USE OF PRODUCT, OR INFORMATION, INCLUDING WARRANTIES OR CONDITIONS OF MERCHANTABILITY, FITNESS FOR A PARTICULAR PURPOSE, ACCURACY OF INFORMATION, OR NONINFRINGEMENT.**
- Do not use or otherwise make available Product or related software or technology for any military purposes, including without limitation, for the design, development, use, stockpiling or manufacturing of nuclear, chemical, or biological weapons or missile technology products (mass destruction weapons). Product and related software and technology may be controlled under the applicable export laws and regulations including, without limitation, the Japanese Foreign Exchange and Foreign Trade Law and the U.S. Export Administration Regulations. Export and re-export of Product or related software or technology are strictly prohibited except in compliance with all applicable export laws and regulations.
- Please contact your TOSHIBA sales representative for details as to environmental matters such as the RoHS compatibility of Product. Please use Product in compliance with all applicable laws and regulations that regulate the inclusion or use of controlled substances, including without limitation, the EU RoHS Directive. **TOSHIBA ASSUMES NO LIABILITY FOR DAMAGES OR LOSSES OCCURRING AS A RESULT OF NONCOMPLIANCE WITH APPLICABLE LAWS AND REGULATIONS.**