

800 mA Fixed-Output CMOS LDO with Shutdown

Features

- Very Low Dropout Voltage
- 800 mA Output Current
- High Output Voltage Accuracy
- Standard or Custom Output Voltages
- Overcurrent and Overtemperature Protection

Applications

- Battery Operated Systems
- Portable Computers
- Medical Instruments
- Instrumentation
- Cellular/GSM/PHS Phones
- Linear Post-Regulators for SMPS
- Pagers

Typical Application

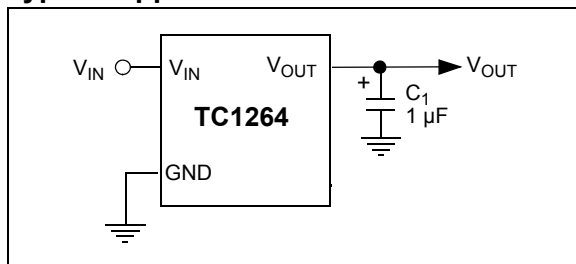

Description

The TC1264 is a fixed output, high accuracy (typically $\pm 0.5\%$) CMOS low dropout regulator. Designed specifically for battery-operated systems, the TC1264's CMOS construction eliminates wasted ground current, significantly extending battery life. Total supply current is typically $80\ \mu\text{A}$ at full load (20 to 60 times lower than in bipolar regulators).

TC1264 key features include ultra low noise operation, very low dropout voltage (typically 450 mV at full load), and fast response to step changes in load.

The TC1264 incorporates both over temperature and over current protection. The TC1264 is stable with an output capacitor of only $1\ \mu\text{F}$ and has a maximum output current of 800 mA. It is available in 3-Pin SOT-223, 3-Pin TO-220 and 3-Pin DDPACK packages.

Package Type

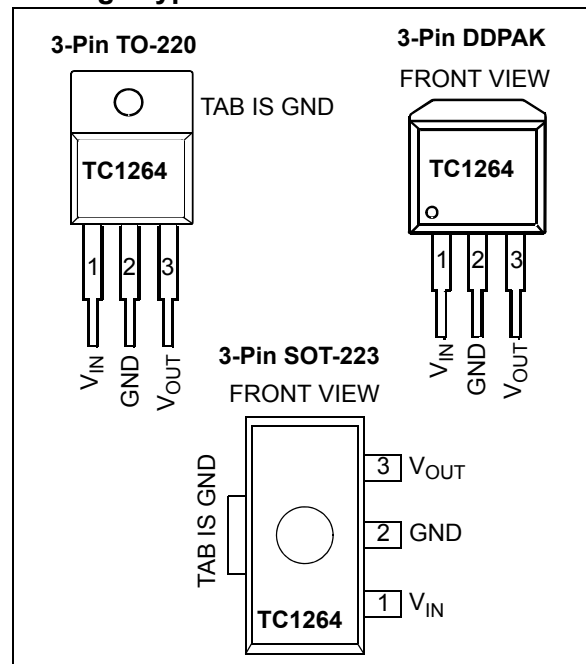

TC1264

1.0 ELECTRICAL CHARACTERISTICS

Absolute Maximum Ratings †

Input Voltage	6.5V
Output Voltage.....	(V _{SS} – 0.3V) to (V _{IN} + 0.3V)
Power Dissipation.....	Internally Limited (Note 8)
Maximum Voltage on Any Pin	V _{IN} +0.3V to -0.3V
Operating Temperature Range.....	-40°C < T _J < 125°C
Storage Temperature.....	-65°C to +150°C

† **Notice:** Stresses above those listed under "Maximum Ratings" may cause permanent damage to the device. This is a stress rating only and functional operation of the device at those or any other conditions above those indicated in the operation listings of this specification is not implied. Exposure to maximum rating conditions for extended periods may affect device reliability.

DC CHARACTERISTICS

Electrical Specifications: Unless otherwise indicated, V _{IN} = V _R + 1.5V, (Note 1), I _L = 100 μA, C _L = 3.3 μF, $\overline{\text{SHDN}} > V_{IH}$, T _A = +25°C. Boldface type specifications apply for junction temperatures of -40°C to +125°C.						
Parameters	Sym	Min	Typ	Max	Units	Conditions
Input Operating Voltage	V _{IN}	2.7	—	6.0	V	Note 2
Maximum Output Current	I _{OUTMAX}	800	—	—	mA	
Output Voltage	V _{OUT}	V_R – 2.5%	V _R ± 0.5%	V_R + 2.5%	V	V _R ≥ 2.5V
		V_R – 2%	V _R ± 0.5%	V_R + 3%		V _R = 1.8V
		V_R – 7%	—	V_R + 3%		I _L = 0.1 mA to 800 mA (Note 3)
V _{OUT} Temperature Coefficient	ΔV _{OUT} /ΔT	—	40	—	ppm/°C	Note 4
Line Regulation	ΔV _{OUT} /ΔV _{IN}	—	0.007	0.35	%	(V _R + 1V) ≤ V _{IN} ≤ 6V
Load Regulation (Note 5)	ΔV _{OUT} /V _{OUT}	-0.01	0.002	0	%/mA	I _L = 0.1 mA to I _{OUTMAX}
Dropout Voltage (Note 6)	V _{IN} –V _{OUT}	—	20	30	mV	V _R ≥ 2.5V, I _L = 100 μA
		—	50	160		I _L = 100 mA
		—	150	480		I _L = 300 mA
		—	260	800		I _L = 500 mA
		—	450	1300		I _L = 800 mA
		—	1000	1200		V _R = 1.8V, I _L = 500 mA
		—	1200	1400		I _L = 800 mA
Supply Current	I _{DD}	—	80	130	μA	$\overline{\text{SHDN}} = V_{IH}$, I _L = 0
Power Supply Rejection Ratio	PSRR	—	64	—	db	F ≤ 1 kHz
Output Short Circuit Current	I _{OUTSC}	—	1200	—	mA	V _{OUT} = 0V

- Note 1:** V_R is the regulator output voltage setting.
- 2:** The minimum V_{IN} has to justify the conditions: V_{IN} ≥ V_R + V_{DROPOUT} and V_{IN} ≥ 2.7V for I_L = 0.1 mA to I_{OUTMAX}.
- 3:** This accuracy represents the worst-case over the entire output current and temperature range.
- 4:**
- $$TCV_{OUT} = \frac{(V_{OUTMAX} - V_{OUTMIN}) - 10^6}{V_{OUT} \times \Delta T}$$
- 5:** Regulation is measured at a constant junction temperature using low duty cycle pulse testing. Load regulation is tested over a load range from 0.1 mA to the maximum specified output current. Changes in output voltage due to heating effects are covered by the thermal regulation specification.
- 6:** Dropout voltage is defined as the input-to-output differential at which the output voltage drops 2% below its nominal value measured at a 1.5V differential.
- 7:** Thermal regulation is defined as the change in output voltage at a time T after a change in power dissipation is applied, excluding load or line regulation effects. Specifications are for a current pulse equal to I_{LMAX} at V_{IN} = 6V for T = 10 ms.
- 8:** The maximum allowable power dissipation is a function of ambient temperature, the maximum allowable junction temperature and the thermal resistance from junction-to-air (i.e., T_A, T_J, θ_{JA}). Exceeding the maximum allowable power dissipation causes the device to initiate thermal shutdown. Please see **Section 5.0 "Thermal Considerations"** for more details..

DC CHARACTERISTICS (CONTINUED)

Electrical Specifications: Unless otherwise indicated, $V_{IN} = V_R + 1.5V$, (Note 1), $I_L = 100 \mu A$, $C_L = 3.3 \mu F$, $\overline{SHDN} > V_{IH}$, $T_A = +25^\circ C$. Boldface type specifications apply for junction temperatures of $-40^\circ C$ to $+125^\circ C$.						
Parameters	Sym	Min	Typ	Max	Units	Conditions
Thermal Regulation	$\Delta V_{OUT}/\Delta P_D$	—	0.04	—	V/W	Note 7
Output Noise	eN	—	260	—	nV/ \sqrt{Hz}	$I_L = I_{OUTMAX}$, F = 10 kHz

Note 1: V_R is the regulator output voltage setting.

2: The minimum V_{IN} has to justify the conditions: $V_{IN} \geq V_R + V_{DROPOUT}$ and $V_{IN} \geq 2.7V$ for $I_L = 0.1 mA$ to I_{OUTMAX} .

3: This accuracy represents the worst-case over the entire output current and temperature range.

4:

$$TCV_{OUT} = \frac{(V_{OUTMAX} - V_{OUTMIN}) - 10^6}{V_{OUT} \times \Delta T}$$

5: Regulation is measured at a constant junction temperature using low duty cycle pulse testing. Load regulation is tested over a load range from 0.1 mA to the maximum specified output current. Changes in output voltage due to heating effects are covered by the thermal regulation specification.

6: Dropout voltage is defined as the input-to-output differential at which the output voltage drops 2% below its nominal value measured at a 1.5V differential.

7: Thermal regulation is defined as the change in output voltage at a time T after a change in power dissipation is applied, excluding load or line regulation effects. Specifications are for a current pulse equal to I_{LMAX} at $V_{IN} = 6V$ for T = 10 ms.

8: The maximum allowable power dissipation is a function of ambient temperature, the maximum allowable junction temperature and the thermal resistance from junction-to-air (i.e., T_A , T_J , θ_{JA}). Exceeding the maximum allowable power dissipation causes the device to initiate thermal shutdown. Please see **Section 5.0 "Thermal Considerations"** for more details..

TEMPERATURE CHARACTERISTICS

Electrical Specifications: Unless otherwise indicated, $V_{IN} = V_R + 1.5V$, $I_L = 100 \mu A$, $C_L = 3.3 \mu F$, $\overline{SHDN} > V_{IH}$, $T_A = +25^\circ C$.						
Parameters	Sym	Min	Typ	Max	Units	Conditions
Temperature Ranges						
Specified Temperature Range	T_A	-40	—	+125	$^\circ C$	(Note 1)
Operating Temperature Range	T_J	-40	—	+125	$^\circ C$	
Storage Temperature Range	T_A	-65	—	+150	$^\circ C$	
Thermal Package Resistances						
Thermal Resistance, 3L-SOT-223	θ_{JA}	—	59	—	$^\circ C/W$	
Thermal Resistance, 3L-DDPAK	θ_{JA}	—	71	—	$^\circ C/W$	
Thermal Resistance, 3L-TO-220	θ_{JA}	—	71	—	$^\circ C/W$	

Note 1: Operation in this range must not cause T_J to exceed Maximum Junction Temperature ($+125^\circ C$).

TC1264

2.0 TYPICAL PERFORMANCE CURVES

Note: The graphs and tables provided following this note are a statistical summary based on a limited number of samples and are provided for informational purposes only. The performance characteristics listed herein are not tested or guaranteed. In some graphs or tables, the data presented may be outside the specified operating range (e.g., outside specified power supply range) and therefore outside the warranted range.

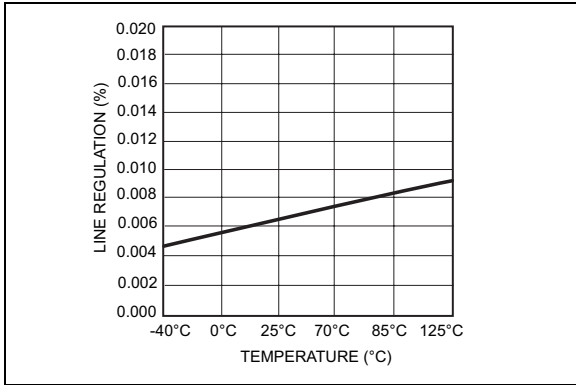

FIGURE 2-1: Line Regulation vs. Temperature.

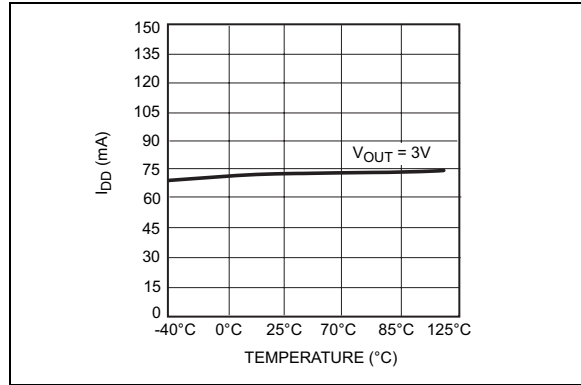

FIGURE 2-4: I_{DD} vs. Temperature.

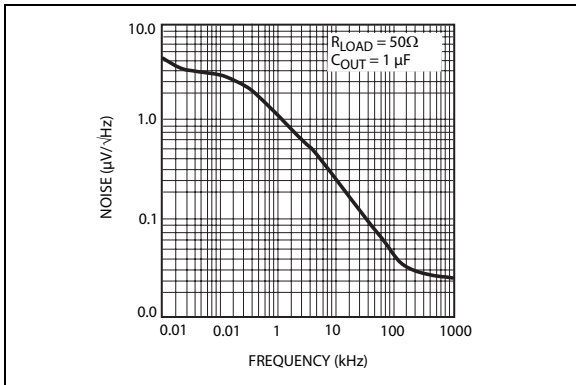

FIGURE 2-2: Output Noise vs. Frequency.

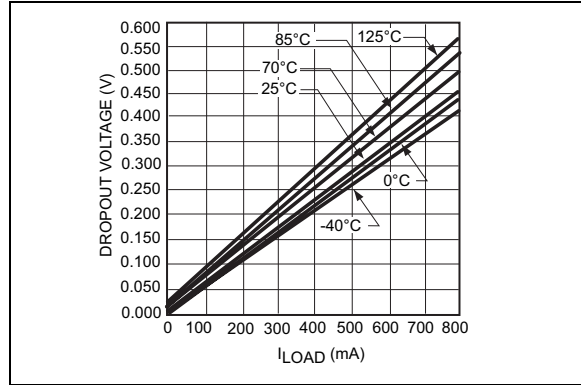

FIGURE 2-5: 3.0V Dropout Voltage vs. I_{LOAD} .

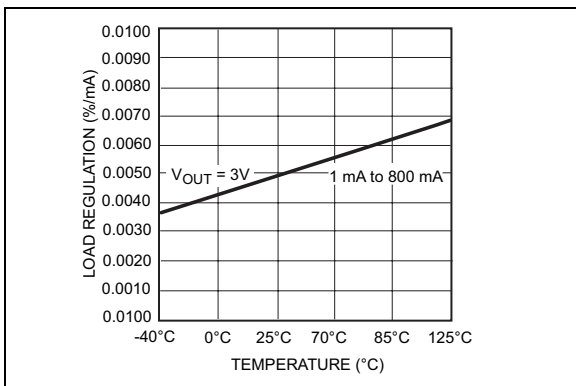

FIGURE 2-3: Load Regulation vs. Temperature.

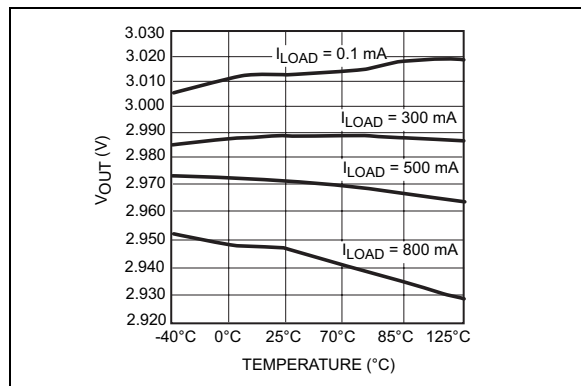

FIGURE 2-6: 3.0V V_{OUT} vs. Temperature.

3.0 PIN DESCRIPTIONS

The descriptions of the pins are listed in [Table 3-1](#).

TABLE 3-1: PIN FUNCTION TABLE

Pin No. 3-Pin SOT-223 3-Pin TO-220 3-Pin DDPAK	Symbol	Description
1	V_{IN}	Unregulated supply input
2	GND	Ground terminal
3	V_{OUT}	Regulated voltage output.

3.1 Unregulated Supply (V_{IN})

Unregulated supply input.

3.3 Regulated Output Voltage (V_{OUT})

Regulated voltage output.

3.2 Ground (GND)

Ground terminal.

TC1264

4.0 DETAILED DESCRIPTION

The TC1264 is a precision, fixed output LDO. Unlike bipolar regulators, the TC1264's supply current does not increase with load current. In addition, V_{OUT} remains stable and within regulation over the entire 0mA to $I_{LOADMAX}$ load current range (an important consideration in RTC and CMOS RAM battery back-up applications).

Figure 4-1 shows a typical application circuit.

FIGURE 4-1: TYPICAL APPLICATION CIRCUIT

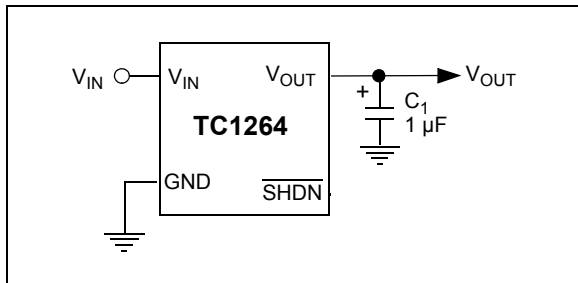

4.1 Output Capacitor

A 1 µF (min) capacitor from V_{OUT} to ground is required. The output capacitor should have an effective series resistance greater than 0.1Ω and less than 5Ω. A 1 µF capacitor should be connected from V_{IN} to GND if there is more than 10 inches of wire between the regulator and the AC filter capacitor, or if a battery is used as the power source. Aluminum electrolytic or tantalum capacitor types can be used. (Since many aluminum electrolytic capacitors freeze at approximately -30°C, solid tantalums are recommended for applications operating below -25°C.) When operating from sources other than batteries, supply-noise rejection and transient response can be improved by increasing the value of the input and output capacitors and employing passive filtering techniques.

5.0 THERMAL CONSIDERATIONS

5.1 Thermal Shutdown

Integrated thermal protection circuitry shuts the regulator off when die temperature exceeds 160°C. The regulator remains off until the die temperature drops to approximately 150°C.

5.2 Power Dissipation

The amount of power the regulator dissipates is primarily a function of input and output voltage, and output current. The following equation is used to calculate worst-case actual power dissipation:

EQUATION 5-1:

$$P_D = (V_{INMAX} - V_{OUTMIN})I_{LOADMAX}$$

Where:

- P_D = Worst-case actual power dissipation
- V_{INMAX} = Maximum voltage on V_{IN}
- V_{OUTMIN} = Minimum regulator output voltage
- $I_{LOADMAX}$ = Maximum output (load) current

The maximum allowable power dissipation (Equation 5-2) is a function of the maximum ambient temperature (T_{AMAX}), the maximum allowable die temperature (T_{JMAX}) and the thermal resistance from junction-to-air (θ_{JA}).

EQUATION 5-2:

$$P_{DMAX} = \frac{(T_{JMAX} - T_{AMAX})}{\theta_{JA}}$$

Where all terms are previously defined.

Table 5-1 and Table 5-2 show various values of θ_{JA} for the TC1264 packages.

TABLE 5-1: THERMAL RESISTANCE GUIDELINES FOR TC1264 IN SOT-223 PACKAGE

Copper Area (Topside)*	Copper Area (Backside)	Board Area	Thermal Resistance (θ_{JA})
2500 sq mm	2500 sq mm	2500 sq mm	45°C/W
1000 sq mm	2500 sq mm	2500 sq mm	45°C/W
225 sq mm	2500 sq mm	2500 sq mm	53°C/W
100 sq mm	2500 sq mm	2500 sq mm	59°C/W
1000 sq mm	1000 sq mm	1000 sq mm	52°C/W
1000 sq mm	0 sq mm	1000 sq mm	55°C/W

* Tab of device attached to topside copper

TABLE 5-2: THERMAL RESISTANCE GUIDELINES FOR TC1264 IN 3-PIN DDPACK/TO-220 PACKAGE

Copper Area (Topside)*	Copper Area (Backside)	Board Area	Thermal Resistance (θ_{JA})
2500 sq mm	2500 sq mm	2500 sq mm	25°C/W
1000 sq mm	2500 sq mm	2500 sq mm	27°C/W
125 sq mm	2500 sq mm	2500 sq mm	35°C/W

* Tab of device attached to topside copper

Equation 5-1 can be used in conjunction with Equation 5-2 to ensure regulator thermal operation is within limits. For example:

Given:

- $V_{INMAX} = 3.3V \pm 10\%$
- $V_{OUTMIN} = 2.7V \pm 0.5\%$
- $I_{LOADMAX} = 275 \text{ mA}$
- $T_{JMAX} = 125^\circ\text{C}$
- $T_{AMAX} = 95^\circ\text{C}$
- $\theta_{JA} = 59^\circ\text{C/W (SOT-223)}$

Find:

- Actual power dissipation.
- Maximum allowable dissipation

Actual power dissipation:

$$P_D \approx (V_{INMAX} - V_{OUTMIN})I_{LOADMAX}$$

$$P_D = (3.3 \times 1.1) - (2.7 \times .995)275 \times 10^{-3}$$

$$P_D = 260 \text{ mW}$$

Maximum allowable power dissipation:

$$P_{DMAX} = \frac{T_{JMAX} - T_{AMAX}}{\theta_{JA}}$$

$$P_{DMAX} = \frac{(125 - 95)}{59}$$

$$P_{DMAX} = 508 \text{ mW}$$

In this example, the TC1264 dissipates a maximum of 260 mW; below the allowable limit of 508 mW. In a similar manner, Equation 5-1 and Equation 5-2 can be used to calculate maximum current and/or input voltage limits. For example, the maximum allowable V_{IN} , is found by substituting the maximum allowable power dissipation of 508mW into Equation 5-1, from which $V_{INMAX} = 4.6V$.

TC1264

6.0 PACKAGING INFORMATION

6.1 Package Marking Information

3-Lead DPAK

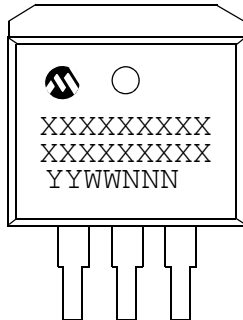

Example

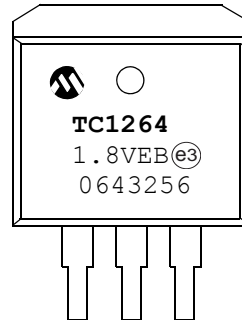

3-Lead SOT-223

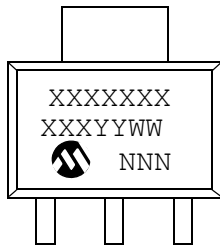

Example

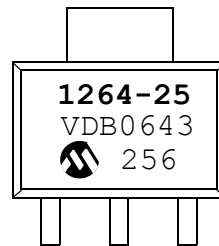

3-Lead TO-220

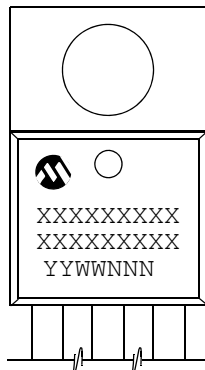

Example

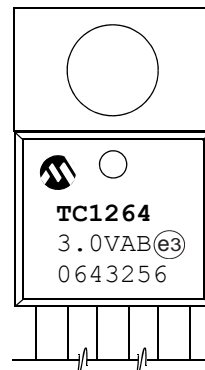

Legend:	XX...X	Customer-specific information
	Y	Year code (last digit of calendar year)
	YY	Year code (last 2 digits of calendar year)
	WW	Week code (week of January 1 is week '01')
	NNN	Alphanumeric traceability code
	(e3)	Pb-free JEDEC designator for Matte Tin (Sn)
	*	This package is Pb-free. The Pb-free JEDEC designator (e3) can be found on the outer packaging for this package.

Note: In the event the full Microchip part number cannot be marked on one line, it will be carried over to the next line, thus limiting the number of available characters for customer-specific information.

3-Lead Plastic (EB) (DDPAK)

Note: For the most current package drawings, please see the Microchip Packaging Specification located at <http://www.microchip.com/packaging>

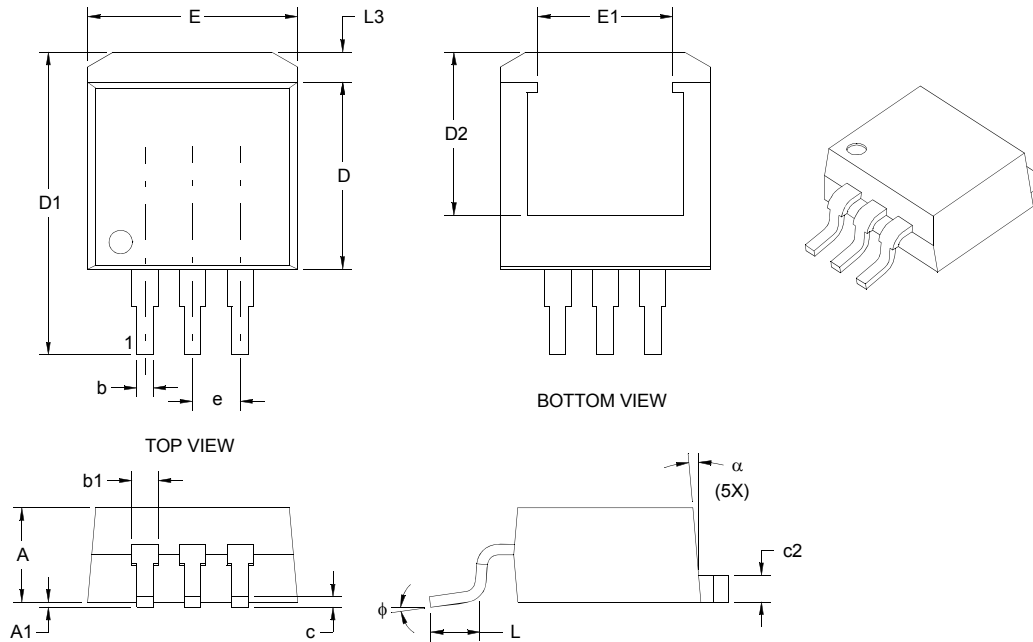

Dimension Limits	Units	INCHES*			MILLIMETERS		
		MIN	NOM	MAX	MIN	NOM	MAX
Number of Pins			3			3	
Pitch	e	1.00 BSC			2.54 BSC		
Overall Height	A	.170	.177	.183	4.32	4.50	4.65
Standoff §	A1	.000	.005	.010	0.00	0.13	0.25
Overall Width	E	.385	.398	.410	9.78	10.11	10.41
Exposed Pad Width	E1	.256 REF			6.50 REF		
Molded Package Length	D	.330	.350	.370	8.38	8.89	9.40
Overall Length	D1	.549	.577	.605	13.94	14.66	15.37
Exposed Pad Length	D2	.303 REF			7.70 REF		
Lead Thickness	c	.014	.020	.026	0.36	0.51	0.66
Pad Thickness	c2	.045	--	.055	1.14	--	1.40
Lower Lead Width	b	.026	.032	.037	0.66	0.81	0.94
Upper Lead Width	b1	.049	.050	.051	1.24	1.27	1.30
Foot Length	L	.068	--	.110	1.73	--	2.79
Pad Length	L3	.045	--	.067	1.14	--	1.70
Foot Angle	φ	--	--	8°	--	--	8°
Mold Draft Angle	α	3°	--	7°	3°	--	7°

* Controlling Parameter

§ Significant Characteristic

Notes:

Dimensions D and E do not include mold flash or protrusions. Mold flash or protrusions shall not exceed .010" (0.254mm) per side.

BSC: Basic Dimension. Theoretically, exact value shown without tolerances.

See ASME Y14.5M

REF: Reference Dimension, usually without tolerance, for information purposes only.

See ASME Y14.5M

JEDEC equivalent: TO-252

Drawing No. C04-011

Revised 07-19-05

TC1264

3-Lead Plastic Small Outline Transistor (DB) (SOT-223)

Note: For the most current package drawings, please see the Microchip Packaging Specification located at <http://www.microchip.com/packaging>

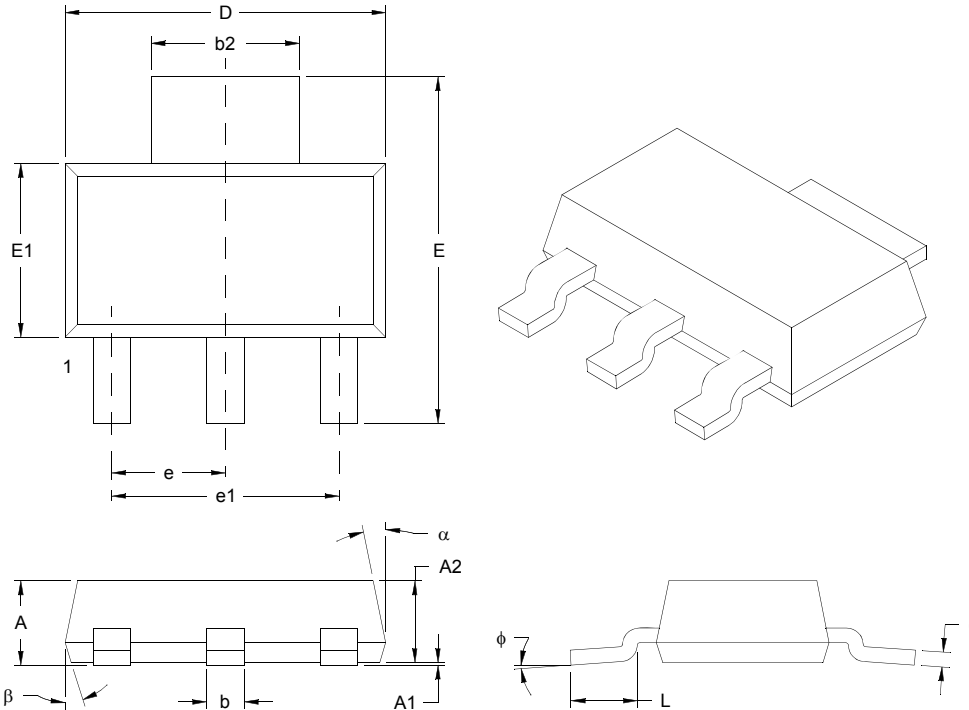

Dimension Limits	Units	INCHES			MILLIMETERS*		
		MIN	NOM	MAX	MIN	NOM	MAX
Pitch	e	.091 BSC			2.30 BSC		
Outside lead pitch (basic)	e1	.181 BSC			4.60 BSC		
Overall Height	A	–	–	.071	–	–	1.80
Standoff	A1	.001	–	.004	0.02	–	0.10
Molded Package Height	A2	.061	.063	.065	1.55	1.60	1.65
Overall Width	E	.264	.276	.287	6.70	7.00	7.30
Molded Package Width	E1	.130	.138	.146	3.30	3.50	3.70
Overall Length	D	.248	.256	.264	6.30	6.50	6.70
Lead Thickness	c	.009	.012	.014	0.23	0.30	0.35
Lead Width	b	.026	.030	.033	0.65	0.76	0.85
Tab Lead Width	b2	.114	.118	.124	2.90	3.00	3.15
Foot Length	L	.035	–	–	0.90	–	–
Lead Angle	φ	0°	–	10°	–	0.37	10°
Mold Draft Angle, Top	α	10°	–	16°	10°	–	16°
Mold Draft Angle, Bottom	β	10°	–	16°	10°	–	16°

* Controlling Parameter

Notes:

Dimensions D and E1 do not include mold flash or protrusions. Mold flash or protrusions shall not exceed .005" (0.127mm) per side.

BSC: Basic Dimension. Theoretically exact value shown without tolerances.

See ASME Y14.5M

JEDEC Equivalent TO-261 AA

Drawing No. C04-032

Revised 09-13-05

3-Lead Plastic Transistor Outline (AB) (TO-220)

Note: For the most current package drawings, please see the Microchip Packaging Specification located at <http://www.microchip.com/packaging>

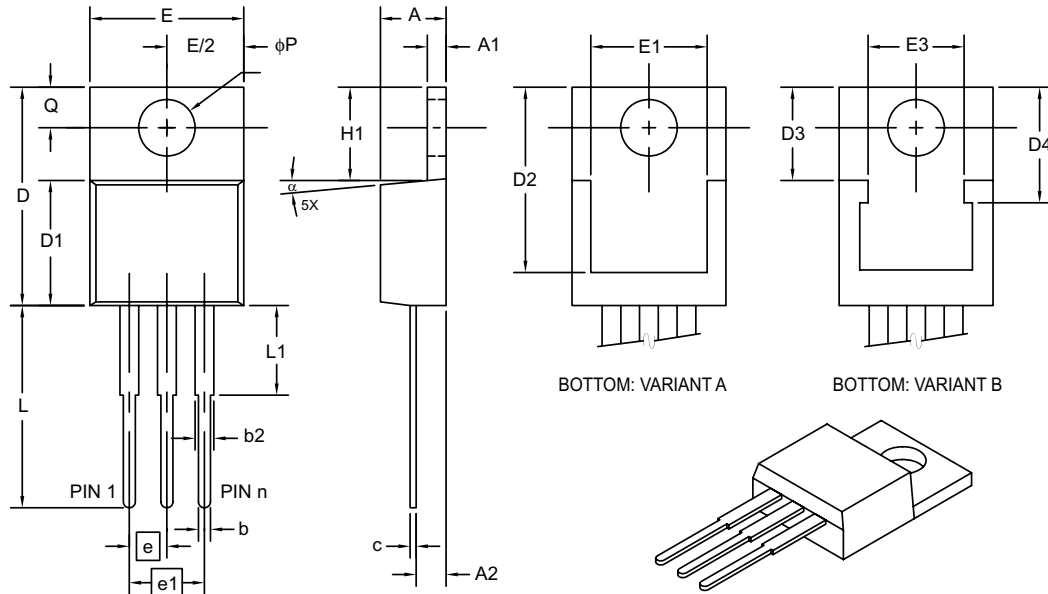

Dimension Limits	Units	INCHES*			MILLIMETERS		
		MIN	NOM	MAX	MIN	NOM	MAX
Number of Pins	n		3			3	
Pitch	e	.100 BSC			2.54 BSC		
Overall Pin Pitch	e1	.200 BSC			5.08 BSC		
Overall Height	A	.140	-	.190	3.56	-	4.83
Tab Thickness	A1	.020	-	.055	0.51	-	1.40
Base to Lead	A2	.080	-	.120	2.03	-	3.05
Overall Width	E	.380	-	.420	9.65	-	10.67
Exposed Tab Width	E1	.270	-	.350	6.86	-	8.89
– (SEE BOTTOM VARIANT B)	E3	.251	.256	.261	6.38	6.50	6.63
Hole Center to Tab Edge	Q	.100	-	.120	2.54	-	3.05
Overall Length	D	.560	-	.650	14.22	-	16.51
Molded Package Length	D1	.330	-	.361	8.38	-	9.17
Exposed Tab Length	D2	.480	-	.507	12.19	-	12.88
– (SEE BOTTOM VARIANT B)	D3	.243	.248	.253	6.17	6.30	6.43
– (SEE BOTTOM VARIANT B)	D4	.303	.308	.313	7.70	7.82	7.95
Tab Length	H1	.230	-	.270	5.84	-	6.86
Mounting Hole Diameter	φP	.139	-	.156	3.53	-	3.96
Lead Length	L	.500	-	.580	12.70	-	14.73
Lead Shoulder	L1	-	-	.250	2.10	-	6.35
Foot Angle	α	0	-	8°	0	-	8°
Lead Thickness	c	.012	-	.024	0.30	-	0.61
Lead Width	b	.015	.027	.040	0.38	0.69	1.02
Shoulder Width	b2	.045	.057	.070	1.14	1.45	1.78

*Controlling Parameter

Notes:

Dimensions D1 and E do not include mold flash or protrusions. Mold flash or protrusions shall not exceed .010" (0.254mm) per side.

BSC: Basic Dimension. Theoretically exact value shown without tolerances.

See ASME Y14.5M

Drawing No. C04-158

TC1264

NOTES:

APPENDIX A: REVISION HISTORY

Revision C (October 2006)

- **Section 1.0 “Electrical Characteristics”:**
Changed dropout voltage typical value for $I_L = 500$ mA from 700 to 1000 and maximum value from 1000 to 1200 for. Changed typical value for $I_L = 800$ mA from 890 to 1200
- **Section 6.0 “PackAging Information”:** Added package marking information and package outline drawings
- Added disclaimer to package outline drawings.

Revision B (May 2002)

- Not Documented

Revision A (March 2002)

- Original Release of this Document.

TC1264

NOTES:

PRODUCT IDENTIFICATION SYSTEM

To order or obtain information, e.g., on pricing or delivery, refer to the factory or the listed sales office.

<u>PART NO.</u>	<u>X.XX</u>	<u>XX</u>	<u>XX</u>
Device	Voltage Option	Package	Tape and Reel
Device	TC1264 Fixed Output CMOS LDO		
Voltage Option:*	1.8V = 1.8V 2.5V = 2.5V 3.0V = 3.0V 3.3V = 3.3V * Other output voltages are available. Please contact your local Microchip sales office for details.		
Package	AB = Plastic (TO-220), 3-Lead DB = Plastic (SOT-223), 3-lead DBTR = Plastic (SOT-223), 3-lead, Tape and Reel EB = Plastic Transistor Outline (DDPAK), 3-Lead EBTR = Plastic Transistor Outline (DDPAK), 3-Lead, Tape and Reel		
Examples:			
a)	TC1264-1.8VAB	1.8V LDO, TO-220-3 pkg.	
b)	TC1264-2.5VAB	2.5V LDO, TO-220-3 pkg.	
c)	TC1264-3.0VAB	3.0V LDO, TO-220-3 pkg.	
d)	TC1264-3.3VAB	3.3V LDO, TO-220-3 pkg.	
a)	TC1264-1.8VEBTR	1.8V LDO, DDPAK-3 pkg., Tape and Reel	
b)	TC1264-2.5VEBTR	2.5V LDO, DDPAK-3 pkg., Tape and Reel	
c)	TC1264-3.0VEBTR	3.0V LDO, DDPAK-3 pkg., Tape and Reel	
d)	TC1264-3.3VEBTR	3.3V LDO, DDPAK-3 pkg., Tape and Reel	
a)	TC1264-1.8VDB	1.8V LDO, SOT-223 pkg.	
b)	TC1264-1.8VDBTR	1.8V LDO, SOT-223 pkg., Tape and Reel	
c)	TC1264-2.5VDB	2.5V LDO, SOT-223 pkg.	
d)	TC1264-2.5VDBTR	2.5V LDO, SOT-223 pkg., Tape and Reel	
e)	TC1264-3.0VDB	3.0V LDO, SOT-223 pkg.	
f)	TC1264-3.0VDBTR	3.0V LDO, SOT-223 pkg., Tape and Reel	
g)	TC1264-3.3VDB	3.3V LDO, SOT-223 pkg.	
h)	TC1264-3.3VDBTR	3.3V LDO, SOT-223 pkg., Tape and Reel	

TC1264

NOTES:

Note the following details of the code protection feature on Microchip devices:

- Microchip products meet the specification contained in their particular Microchip Data Sheet.
- Microchip believes that its family of products is one of the most secure families of its kind on the market today, when used in the intended manner and under normal conditions.
- There are dishonest and possibly illegal methods used to breach the code protection feature. All of these methods, to our knowledge, require using the Microchip products in a manner outside the operating specifications contained in Microchip's Data Sheets. Most likely, the person doing so is engaged in theft of intellectual property.
- Microchip is willing to work with the customer who is concerned about the integrity of their code.
- Neither Microchip nor any other semiconductor manufacturer can guarantee the security of their code. Code protection does not mean that we are guaranteeing the product as “unbreakable.”

Code protection is constantly evolving. We at Microchip are committed to continuously improving the code protection features of our products. Attempts to break Microchip's code protection feature may be a violation of the Digital Millennium Copyright Act. If such acts allow unauthorized access to your software or other copyrighted work, you may have a right to sue for relief under that Act.

Information contained in this publication regarding device applications and the like is provided only for your convenience and may be superseded by updates. It is your responsibility to ensure that your application meets with your specifications. MICROCHIP MAKES NO REPRESENTATIONS OR WARRANTIES OF ANY KIND WHETHER EXPRESS OR IMPLIED, WRITTEN OR ORAL, STATUTORY OR OTHERWISE, RELATED TO THE INFORMATION, INCLUDING BUT NOT LIMITED TO ITS CONDITION, QUALITY, PERFORMANCE, MERCHANTABILITY OR FITNESS FOR PURPOSE. Microchip disclaims all liability arising from this information and its use. Use of Microchip devices in life support and/or safety applications is entirely at the buyer's risk, and the buyer agrees to defend, indemnify and hold harmless Microchip from any and all damages, claims, suits, or expenses resulting from such use. No licenses are conveyed, implicitly or otherwise, under any Microchip intellectual property rights.

Trademarks

The Microchip name and logo, the Microchip logo, Accuron, dsPIC, KEELOQ, microID, MPLAB, PIC, PICmicro, PICSTART, PRO MATE, PowerSmart, rfPIC, and SmartShunt are registered trademarks of Microchip Technology Incorporated in the U.S.A. and other countries.

AmpLab, FilterLab, Migratable Memory, MXDEV, MXLAB, SEEVAL, SmartSensor and The Embedded Control Solutions Company are registered trademarks of Microchip Technology Incorporated in the U.S.A.

Analog-for-the-Digital Age, Application Maestro, CodeGuard, dsPICDEM, dsPICDEM.net, dsPICworks, ECAN, ECONOMONITOR, FanSense, FlexROM, fuzzyLAB, In-Circuit Serial Programming, ICSP, ICEPIC, Linear Active Thermistor, Mindi, MiWi, MPASM, MPLIB, MPLINK, PICkit, PICDEM, PICDEM.net, PICLAB, PICtail, PowerCal, PowerInfo, PowerMate, PowerTool, REAL ICE, rFLAB, rfPICDEM, Select Mode, Smart Serial, SmartTel, Total Endurance, UNI/O, WiperLock and ZENA are trademarks of Microchip Technology Incorporated in the U.S.A. and other countries.

SQTP is a service mark of Microchip Technology Incorporated in the U.S.A.

All other trademarks mentioned herein are property of their respective companies.

© 2006, Microchip Technology Incorporated, Printed in the U.S.A., All Rights Reserved.

 Printed on recycled paper.

QUALITY MANAGEMENT SYSTEM
CERTIFIED BY DNV
== ISO/TS 16949:2002 ==

Microchip received ISO/TS-16949:2002 certification for its worldwide headquarters, design and wafer fabrication facilities in Chandler and Tempe, Arizona, Gresham, Oregon and Mountain View, California. The Company's quality system processes and procedures are for its PIC® 8-bit MCUs, KEELOQ® code hopping devices, Serial EEPROMs, microperipherals, nonvolatile memory and analog products. In addition, Microchip's quality system for the design and manufacture of development systems is ISO 9001:2000 certified.



MICROCHIP

WORLDWIDE SALES AND SERVICE

AMERICAS

Corporate Office

2355 West Chandler Blvd.
Chandler, AZ 85224-6199
Tel: 480-792-7200
Fax: 480-792-7277
Technical Support:
<http://support.microchip.com>
Web Address:
www.microchip.com

Atlanta

Alpharetta, GA
Tel: 770-640-0034
Fax: 770-640-0307

Boston

Westborough, MA
Tel: 774-760-0087
Fax: 774-760-0088

Chicago

Itasca, IL
Tel: 630-285-0071
Fax: 630-285-0075

Dallas

Addison, TX
Tel: 972-818-7423
Fax: 972-818-2924

Detroit

Farmington Hills, MI
Tel: 248-538-2250
Fax: 248-538-2260

Kokomo

Kokomo, IN
Tel: 765-864-8360
Fax: 765-864-8387

Los Angeles

Mission Viejo, CA
Tel: 949-462-9523
Fax: 949-462-9608

Santa Clara

Santa Clara, CA
Tel: 408-961-6444
Fax: 408-961-6445

Toronto

Mississauga, Ontario,
Canada
Tel: 905-673-0699
Fax: 905-673-6509

ASIA/PACIFIC

Asia Pacific Office

Suites 3707-14, 37th Floor
Tower 6, The Gateway
Harbour City, Kowloon
Hong Kong
Tel: 852-2401-1200
Fax: 852-2401-3431

Australia - Sydney

Tel: 61-2-9868-6733
Fax: 61-2-9868-6755

China - Beijing

Tel: 86-10-8528-2100
Fax: 86-10-8528-2104

China - Chengdu

Tel: 86-28-8665-5511
Fax: 86-28-8665-7889

China - Fuzhou

Tel: 86-591-8750-3506
Fax: 86-591-8750-3521

China - Hong Kong SAR

Tel: 852-2401-1200
Fax: 852-2401-3431

China - Qingdao

Tel: 86-532-8502-7355
Fax: 86-532-8502-7205

China - Shanghai

Tel: 86-21-5407-5533
Fax: 86-21-5407-5066

China - Shenyang

Tel: 86-24-2334-2829
Fax: 86-24-2334-2393

China - Shenzhen

Tel: 86-755-8203-2660
Fax: 86-755-8203-1760

China - Shunde

Tel: 86-757-2839-5507
Fax: 86-757-2839-5571

China - Wuhan

Tel: 86-27-5980-5300
Fax: 86-27-5980-5118

China - Xian

Tel: 86-29-8833-7250
Fax: 86-29-8833-7256

ASIA/PACIFIC

India - Bangalore

Tel: 91-80-4182-8400
Fax: 91-80-4182-8422

India - New Delhi

Tel: 91-11-4160-8631
Fax: 91-11-4160-8632

India - Pune

Tel: 91-20-2566-1512
Fax: 91-20-2566-1513

Japan - Yokohama

Tel: 81-45-471-6166
Fax: 81-45-471-6122

Korea - Gumi

Tel: 82-54-473-4301
Fax: 82-54-473-4302

Korea - Seoul

Tel: 82-2-554-7200
Fax: 82-2-558-5932 or
82-2-558-5934

Malaysia - Penang

Tel: 60-4-646-8870
Fax: 60-4-646-5086

Philippines - Manila

Tel: 63-2-634-9065
Fax: 63-2-634-9069

Singapore

Tel: 65-6334-8870
Fax: 65-6334-8850

Taiwan - Hsin Chu

Tel: 886-3-572-9526
Fax: 886-3-572-6459

Taiwan - Kaohsiung

Tel: 886-7-536-4818
Fax: 886-7-536-4803

Taiwan - Taipei

Tel: 886-2-2500-6610
Fax: 886-2-2508-0102

Thailand - Bangkok

Tel: 66-2-694-1351
Fax: 66-2-694-1350

EUROPE

Austria - Wels

Tel: 43-7242-2244-39
Fax: 43-7242-2244-393

Denmark - Copenhagen

Tel: 45-4450-2828
Fax: 45-4485-2829

France - Paris

Tel: 33-1-69-53-63-20
Fax: 33-1-69-30-90-79

Germany - Munich

Tel: 49-89-627-144-0
Fax: 49-89-627-144-44

Italy - Milan

Tel: 39-0331-742611
Fax: 39-0331-466781

Netherlands - Drunen

Tel: 31-416-690399
Fax: 31-416-690340

Spain - Madrid

Tel: 34-91-708-08-90
Fax: 34-91-708-08-91

UK - Wokingham

Tel: 44-118-921-5869
Fax: 44-118-921-5820

10/19/06