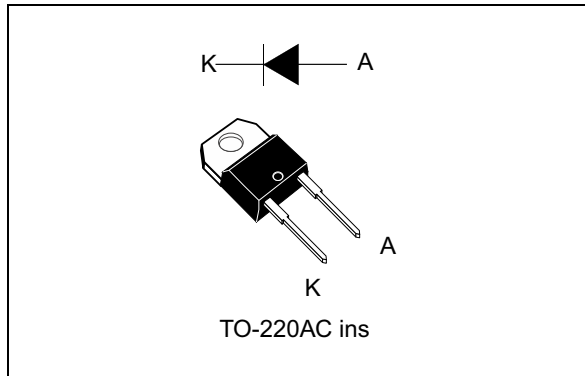

**600 V tandem extra fast diode**

Datasheet – production data

**Features**

- High voltage rectifier
- Tandem diodes in series
- Very low switching losses
- Insulated device with internal ceramic
- Equal thermal conditions for both 300 V diodes
- Static and dynamic equilibrium of internal diodes are warranted by design
- Insulated package:
  - Insulated voltage: 2500 V<sub>RMS</sub> sine

**Description**

This device is part of ST's second generation of 600 V tandem diodes. It has ultralow switching-losses with a minimized  $Q_{RR}$  that makes it perfect for use in circuits working in hard-switching mode. In particular the  $V_F/Q_{RR}$  trade-off positions this device between standard ultrafast diodes and silicon-carbide Schottky rectifiers in terms of price/performance ratio.

The device offers a new positioning giving more flexibility to power-circuit designers looking for good performance while still respecting cost constraints.

Featuring ST's Turbo 2 600 V technology, the device is particularly suited as a boost diode in continuous conduction mode power factor correction circuits.

**Table 1. Device summary**

Symbol	Value
$I_{F(AV)}$	8 A
$V_{RRM}$	600 V
$t_{rr}$ (typ)	13 ns
$I_{RM}$ (typ)	2 A
$V_F$ (typ)	2.5 V
$I_{FRM}$	40 A
$T_j$ (max)	175 °C

# 1 Characteristics

**Table 2. Absolute ratings (limiting values at  $T_j = 25\text{ °C}$ , unless otherwise specified)**

Symbol	Parameter		Value	Unit
$V_{RRM}$	Repetitive peak reverse voltage	$T_j$ from 25 to 150 °C	600	V
		$T_j = -40\text{ °C}$	550	
$I_{F(RMS)}$	Forward rms current		14	A
$I_{F(AV)}$	Average forward current, $\delta = 0.5$ , square wave	$T_c = 80\text{ °C}$	8	A
$I_{FSM}$	Surge non repetitive forward current	$t_p = 10\text{ ms}$ sinusoidal	55	A
$I_{FRM}$	Repetitive peak forward current	$T_c = 80\text{ °C}$ , $\delta = 0.1$	40	A
$T_{stg}$	Storage temperature range		-65 to +175	°C
$T_j$	Operating junction temperature range		-40 to +175	°C

**Table 3. Thermal parameters**

Symbol	Parameter	Value	Unit
$R_{th(j-c)}$	Junction to case	2.9	°C/W

**Table 4. Static electrical characteristics**

Symbol	Parameter	Test conditions	Min.	Typ.	Max.	Unit
$I_R^{(1)}$	Reverse leakage current	$T_j = 25\text{ °C}$	$V_R = V_{RRM}$	-	6	$\mu\text{A}$
		$T_j = 125\text{ °C}$		-	20	
$V_F^{(2)}$	Forward voltage drop	$T_j = 25\text{ °C}$	$I_F = 8\text{ A}$	-	3.4	V
		$T_j = 150\text{ °C}$		-	2.5	

1. Pulse test:  $t_p = 5\text{ ms}$ ,  $\delta < 2\%$
2. Pulse test:  $t_p = 380\text{ }\mu\text{s}$ ,  $\delta < 2\%$

To evaluate the conduction losses use the following equation:

$$P = 2.2 \times I_{F(AV)} + 0.113 I_{F(RMS)}^2$$

Table 5. Dynamic characteristics

Symbol	Parameter	Test conditions		Min.	Typ.	Max.	Unit
$t_{rr}$	Reverse recovery time	$T_j = 25\text{ }^\circ\text{C}$	$I_F = 1\text{ A}, V_R = 30\text{ V},$ $di_F/dt = -50\text{ A}/\mu\text{s}$	-	20	26	ns
			$I_F = 8\text{ A}, V_R = 400\text{ V},$ $di_F/dt = -200\text{ A}/\mu\text{s}$	-	13	17	
$I_{RM}$	Reverse recovery current	$T_j = 125\text{ }^\circ\text{C}$	$I_F = 8\text{ A}, V_R = 400\text{ V},$ $di_F/dt = -200\text{ A}/\mu\text{s}$	-	2	2.6	A
S	Softness factor			-	0.9		-
$Q_{RR}$	Reverse recovery charge	$T_j = 25\text{ }^\circ\text{C}$	$di_F/dt = -200\text{ A}/\mu\text{s}$	-	4		nC
		$T_j = 125\text{ }^\circ\text{C}$		-	20		

Figure 1. Average forward power dissipation versus average forward current

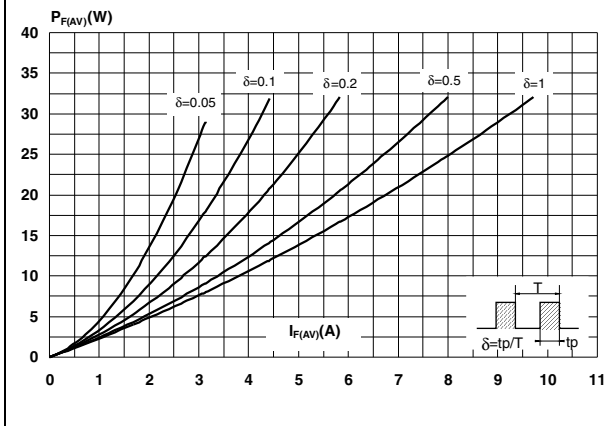

Figure 2. Forward voltage drop versus forward current (typical values)

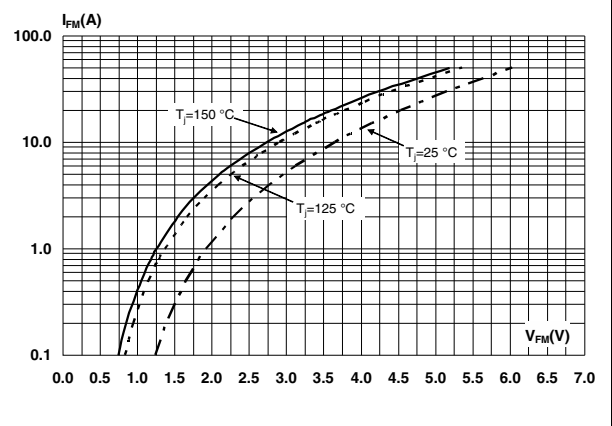

Figure 3. Relative variation of thermal impedance, junction to case, versus pulse duration

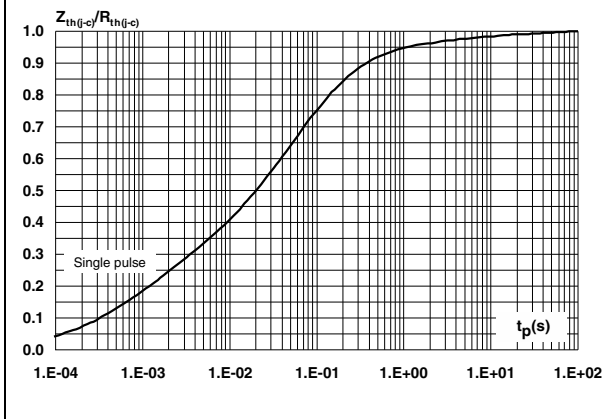
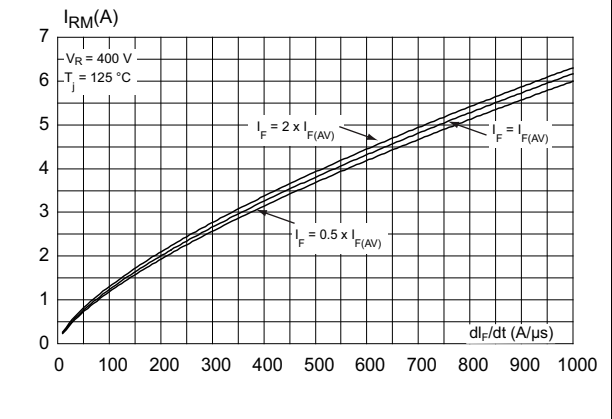
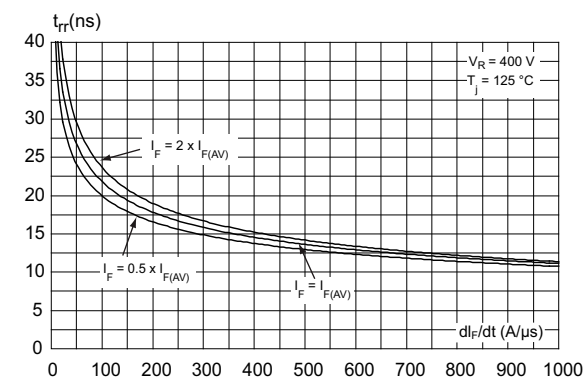

Figure 4. Peak reverse recovery current versus di\_F/dt (typical values)



**Figure 5. Reverse recovery time versus  $di_F/dt$  (typical values)**



**Figure 6. Reverse recovery charges versus  $di_F/dt$  (typical values)**

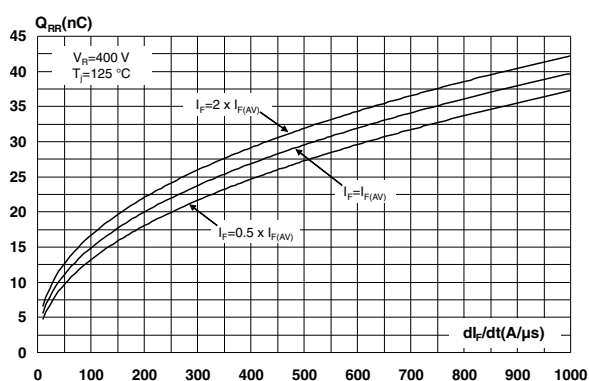

**Figure 7. Reverse recovery softness factor versus  $di_F/dt$  (typical values)**

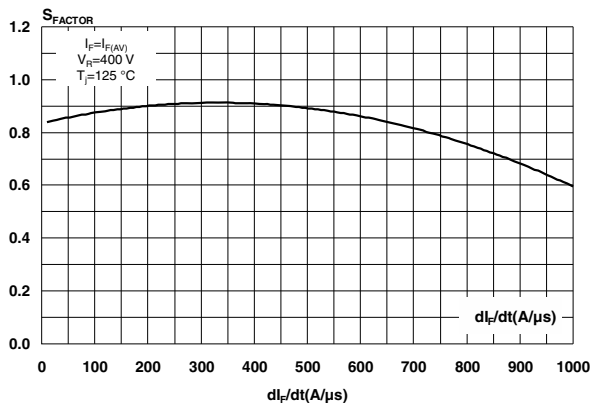

**Figure 8. Relative variations of dynamic parameters versus junction temperature**

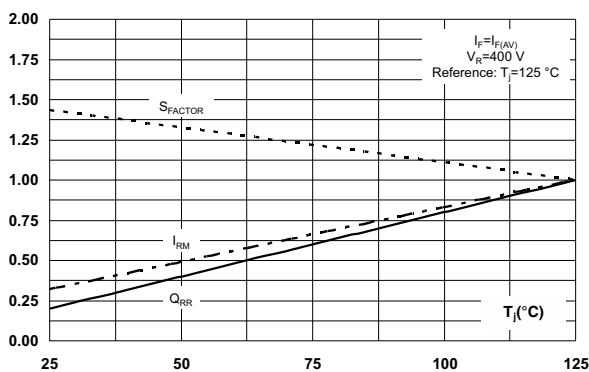

**Figure 9. Junction capacitance versus reverse voltage applied (typical values)**

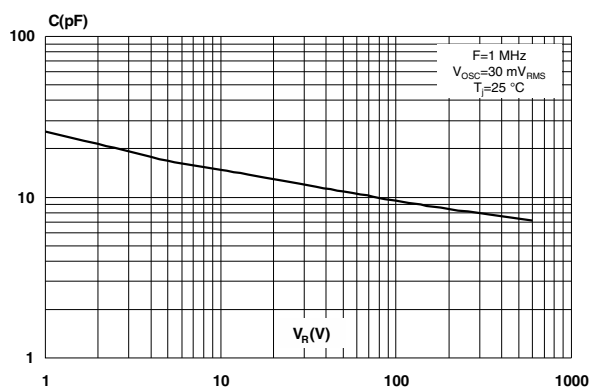

**Figure 10. Relative variation of non-repetitive peak surge forward current versus pulse duration**

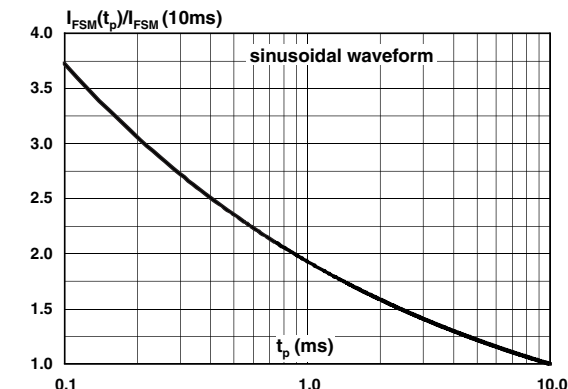
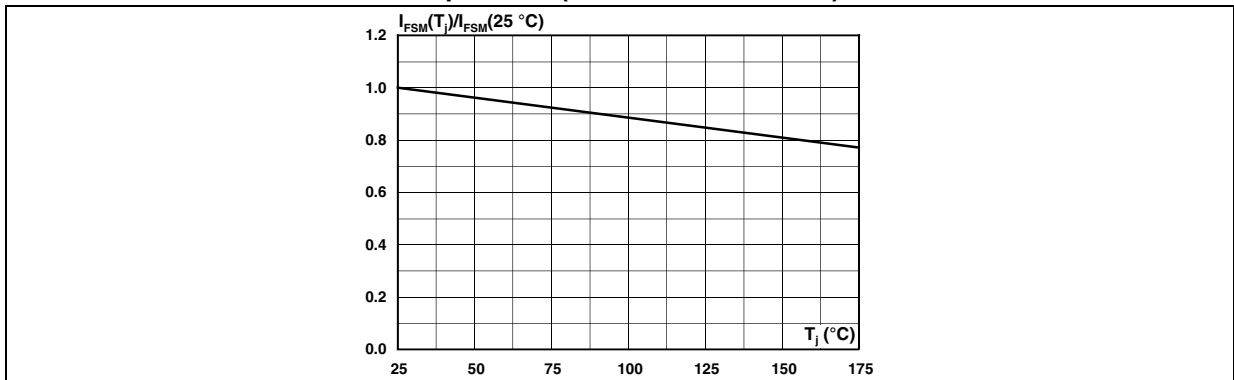

Figure 11. Relative variation of non-repetitive peak surge forward current versus initial junction temperature (sinusoidal waveform)



## 2 Package information

- Epoxy meets UL94, V0
- Cooling method: by conduction (C)
- Recommended torque: 0.55 N·m
- Maximum torque: 0.7 N·m

In order to meet environmental requirements, ST offers these devices in different grades of ECOPACK® packages, depending on their level of environmental compliance. ECOPACK® specifications, grade definitions and product status are available at: [www.st.com](http://www.st.com). ECOPACK® is an ST trademark.

### 2.1 TO-220AC ins. package information

Figure 12. T0-220AC ins. package outline

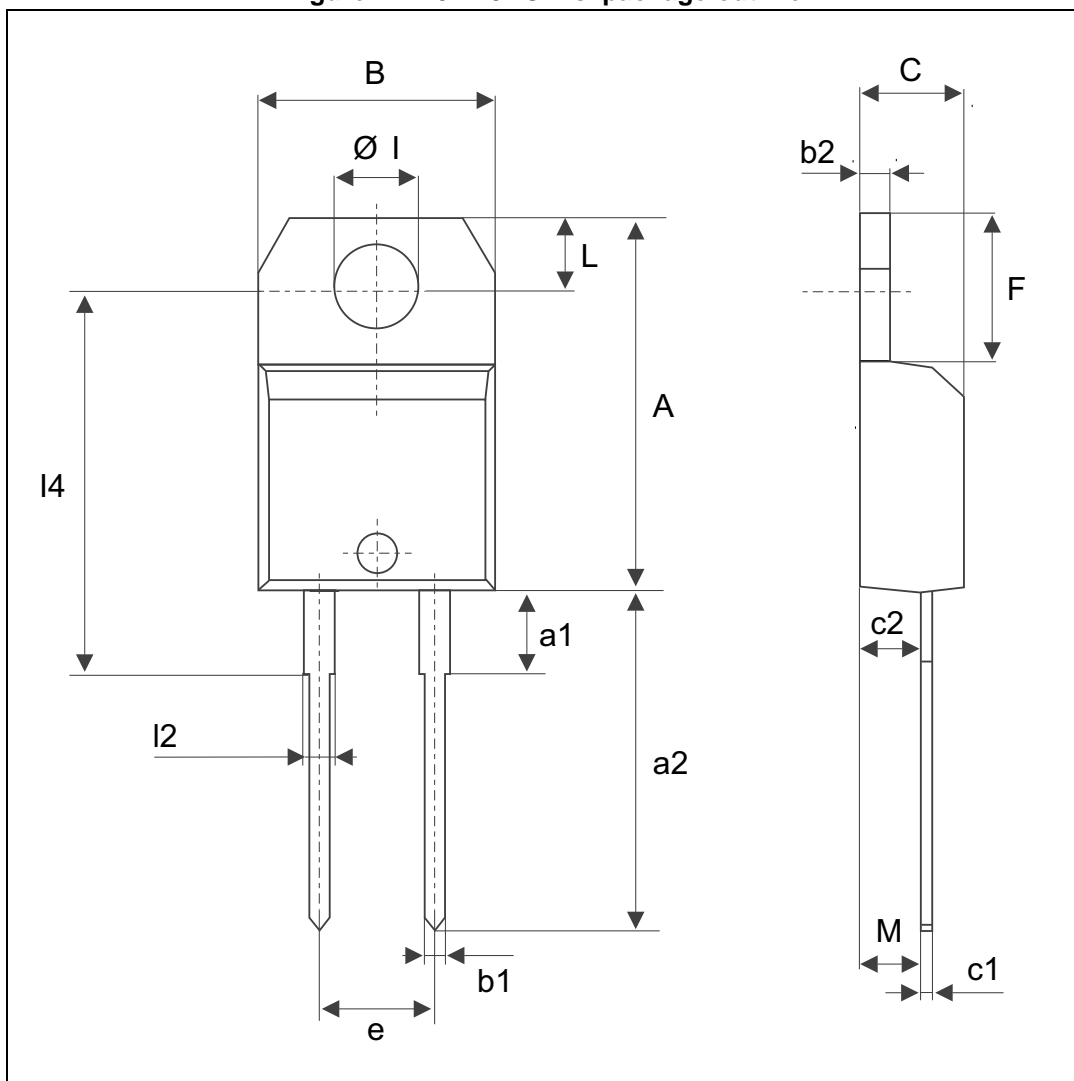

Table 6. T0-220AC ins. package mechanical data

Ref.	Dimensions					
	Millimeters			Inches		
	Min.	Typ.	Max.	Min.	Typ.	Max.
A	15.20		15.90	0.598		0.625
a1		3.75			0.147	
a2	13.00		14.00	0.511		0.551
B	10.00		10.40	0.393		0.409
b1	0.61		0.88	0.024		0.034
b2	1.23		1.32	0.048		0.051
C	4.40		4.60	0.173		0.181
c1	0.49		0.70	0.019		0.027
c2	2.40		2.72	0.094		0.107
e	4.80		5.40	0.189		0.212
F	6.20		6.60	0.244		0.259
ØI	3.75		3.85	0.147		0.151
I4	15.80	16.40	16.80	0.622	0.646	0.661
L	2.65		2.95	0.104		0.116
I2	1.14		1.70	0.044		0.066
M		2.60			0.102	

### 3 Ordering information

Table 7. Ordering information

Order code	Marking	Package	Weight	Base qty	Delivery mode
STTH8ST06DI	STTH8ST06DI	TO-220AC ins	2.3 g	50	Tube

### 4 Revision history

Table 8. Document revision history

Date	Revision	Changes
14-May-2013	1	Initial release
27-Jul-2015	2	Updated <a href="#">Features</a> , <a href="#">Table 2</a> , <a href="#">Table 7</a> , <a href="#">Figure 4</a> and torque value.



**IMPORTANT NOTICE – PLEASE READ CAREFULLY**

STMicroelectronics NV and its subsidiaries ("ST") reserve the right to make changes, corrections, enhancements, modifications, and improvements to ST products and/or to this document at any time without notice. Purchasers should obtain the latest relevant information on ST products before placing orders. ST products are sold pursuant to ST's terms and conditions of sale in place at the time of order acknowledgement.

Purchasers are solely responsible for the choice, selection, and use of ST products and ST assumes no liability for application assistance or the design of Purchasers' products.

No license, express or implied, to any intellectual property right is granted by ST herein.

Resale of ST products with provisions different from the information set forth herein shall void any warranty granted by ST for such product.

ST and the ST logo are trademarks of ST. All other product or service names are the property of their respective owners.

Information in this document supersedes and replaces information previously supplied in any prior versions of this document.

© 2015 STMicroelectronics – All rights reserved