

## High frequency secondary rectifier

### Main product characteristics

$I_{F(AV)}$	2 x 10 A
$V_{RRM}$	300 V
$T_j$ (max)	170° C
$V_F$ (max)	1 V
$t_{rr}$ (typ)	35 ns

### Features and benefits

- Combines highest recovery and reverse voltage performance
- Ultra-fast, soft and noise-free recovery
- Insulated packages: TO-220FPAB  
Electric insulation: 2000 V DC  
Capacitance: 12 pF

### Description

Dual center tap Fast Recovery Epitaxial Diodes suited for Switch Mode Power Supply and high frequency DC/DC converters.

Packaged in TO-220AB, TO-220FPAB, I<sup>2</sup>PAK or D<sup>2</sup>PAK, this device is especially intended for secondary rectification.

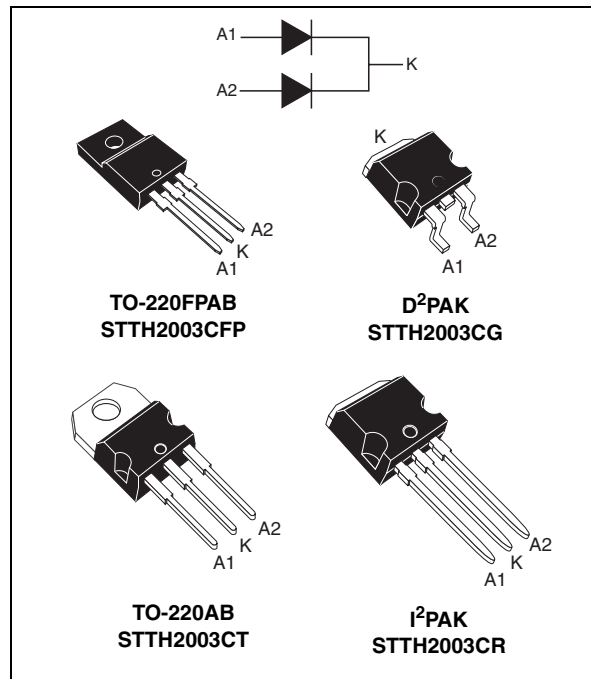

### Order codes

Part Number	Marking
STTH2003CT	STTH2003CT
STTH2003CG	STTH2003CG
STTH2003CG-TR	STTH2003CG
STTH2003CF	STTH2003CF
STTH2003CFP	STTH2003CFP
STTH2003CR	STTH2003CR

# 1 Characteristics

**Table 1. Absolute ratings (limiting values, per diode)**

Symbol	Parameter			Value	Unit	
$V_{RRM}$	Repetitive peak reverse voltage			300	V	
$I_{F(RMS)}$	RMS forward voltage			30	A	
$I_{F(peak)}$	Peak working forward current $\delta = 0.5$	$I^2$ PAK, D <sup>2</sup> PAK, TO-220AB	$T_c = 140^\circ\text{C}$	Per diode Per device	10 20	A
		TO-220FPAB	$T_c = 125^\circ\text{C}$			
$I_{FSM}$	Surge non repetitive forward current		$t_p = 10$ ms sinusoidal	110	A	
$I_{RSM}$	Non repetitive avalanche current		$t_p = 10$ $\mu\text{s}$ square	5	A	
$T_{stg}$	Storage temperature range			-65 to + 175	$^\circ\text{C}$	
$T_j$	Maximum operating junction temperature			175	$^\circ\text{C}$	

**Table 2. Thermal resistance**

Symbol	Parameter		Value (max)	Unit	
$R_{th(j-c)}$	Junction to case	$I^2$ PAK, D <sup>2</sup> PAK, TO-220AB	Per diode	2.5	$^\circ\text{C/W}$
			Total	1.3	
		TO-220FPAB	Per diode	4.6	
			Total	4	
$R_{th(c)}$	$I^2$ PAK, D <sup>2</sup> PAK, TO-220AB	Coupling	0.1		
		TO-220FPAB	Coupling	3.5	

**Table 3. Static electrical characteristics (per diode)**

Symbol	Parameter	Test conditions		Min.	Typ	Max.	Unit
$I_R^{(1)}$	Reverse leakage current	$T_j = 25^\circ\text{C}$	$V_R = 300$ V			20	$\mu\text{A}$
		$T_j = 125^\circ\text{C}$			30	300	
$V_F^{(2)}$	Forward voltage drop	$T_j = 25^\circ\text{C}$	$I_F = 10$ A			1.25	V
		$T_j = 125^\circ\text{C}$			0.85	1	

1. Pulse test:  $t_p = 5$  ms,  $\delta < 2\%$

2. Pulse test:  $t_p = 380$   $\mu\text{s}$ ,  $\delta < 2\%$

**Note:** To evaluate the conduction losses use the following equation:

$$P = 0.75 \times I_{F(AV)} + 0.025 I_F^2 (RMS)$$

Table 4. Recovery Characteristics

Symbol	Parameter	Test conditions		Min.	Typ	Max.	Unit
$t_{rr}$	Reverse recovery time	$T_j = 25^\circ\text{C}$	$I_F = 0.5\text{ A}$ $I_{rr} = 0.25\text{ A}$ $I_R = 1\text{ A}$			25	ns
			$I_F = 1\text{ A}$ $V_R = 30\text{ V}$ $di_F/dt = -50\text{ A}/\mu\text{s}$			35	
$t_{fr}$	Forward recovery time	$T_j = 25^\circ\text{C}$	$I_F = 10\text{ A}$ $di_F/dt = 100\text{ A}/\mu\text{s}$ $V_{FR} = 1.1 \times V_{Fmax}$			230	ns
$V_{FP}$	Peak forward voltage	$T_j = 25^\circ\text{C}$	$I_F = 10\text{ A}$ $di_F/dt = 100\text{ A}/\mu\text{s}$			3.5	V
$I_{RM}$	Reverse recovery current	$T_j = 125^\circ\text{C}$	$I_F = 10\text{ A}$ $V_{CC} = 200\text{ V}$ $di_F/dt = 200\text{ A}/\mu\text{s}$			8	A
$S_{factor}$	Softness factor				0.3		-

Figure 1. Conduction losses versus average forward current (per diode)

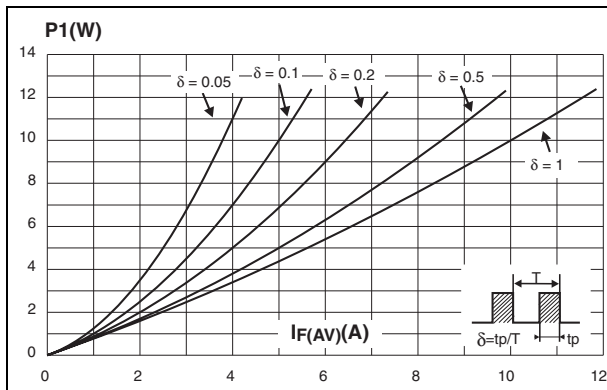

Figure 2. Forward voltage drop versus forward current (maximum values, per diode)

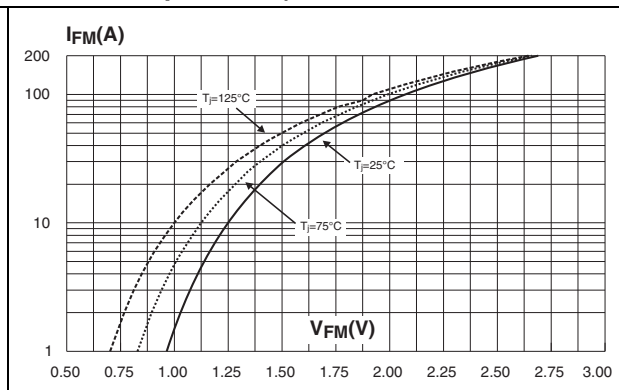

Figure 3. Relative variation of thermal impedance junction to case versus pulse duration (TO-220AB / D<sup>2</sup>PAK / I<sup>2</sup>PAK)

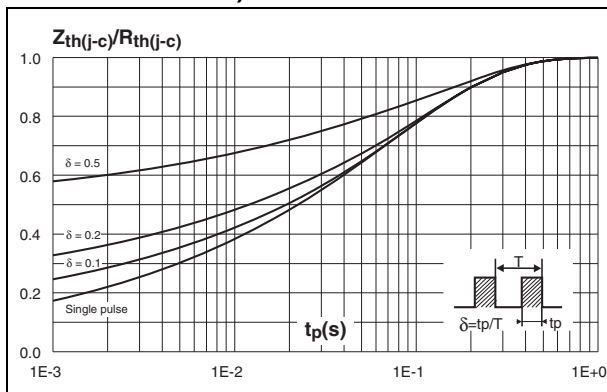

Figure 4. Relative variation of thermal impedance junction to case versus pulse duration (TO-22FP0AB)

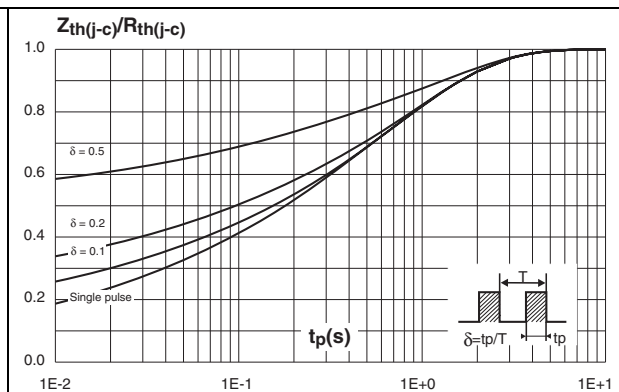

Figure 5. Peak reverse recovery current versus  $di_F/dt$  (90% confidence, per diode)

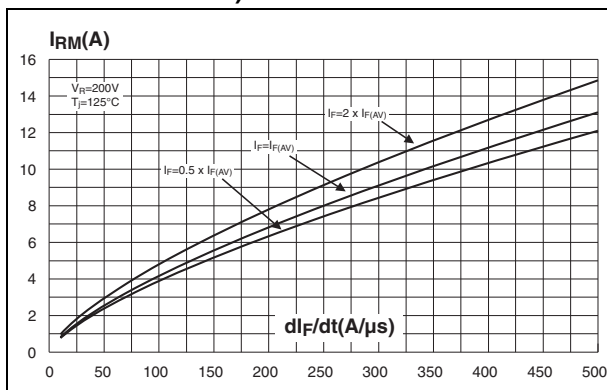
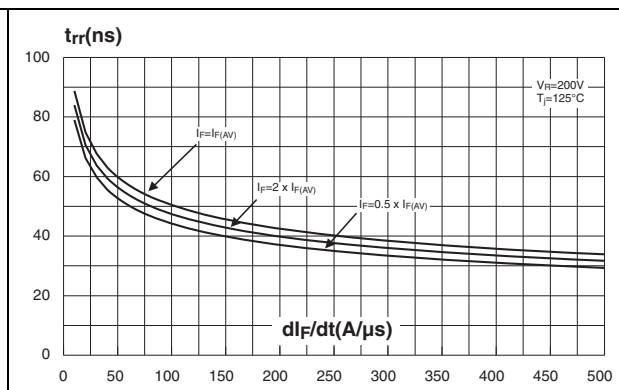
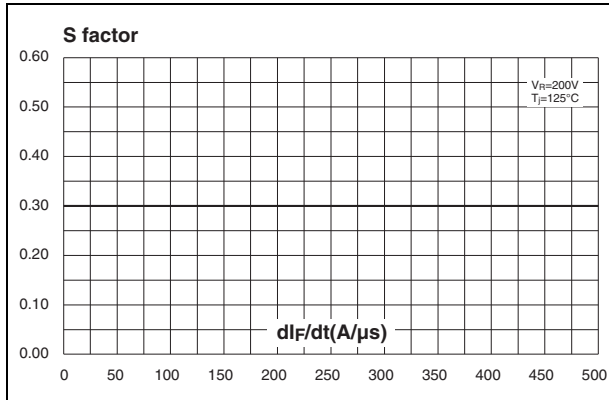

Figure 6. Reverse recovery time versus  $di_F/dt$  (90% confidence, per diode)



**Figure 7. Softness factor (tb/ta) versus  $di_F/dt$  (typical values, per diode)**



**Figure 8. Relative variation of dynamic parameters versus junction temperature (reference:  $T_j = 125^\circ\text{C}$ )**

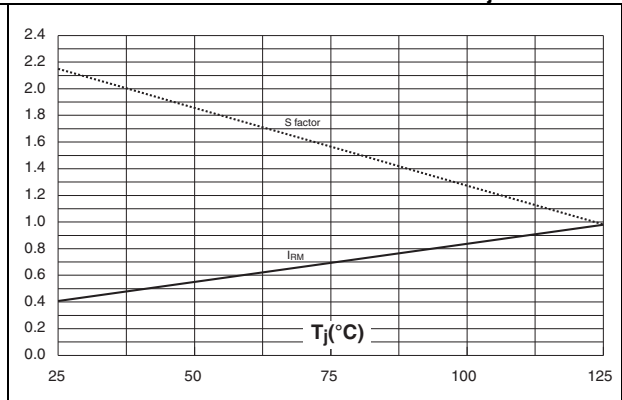

**Figure 9. Transient peak forward voltage versus  $di_F/dt$  (90% confidence, per diode) (TO-220AB)**

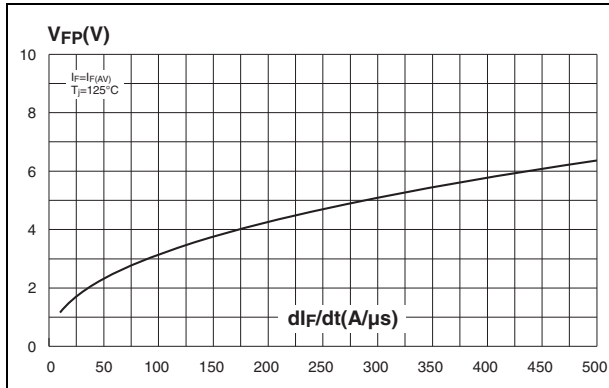

**Figure 10. Forward recovery time versus  $di_F/dt$  (90% confidence, per diode)**

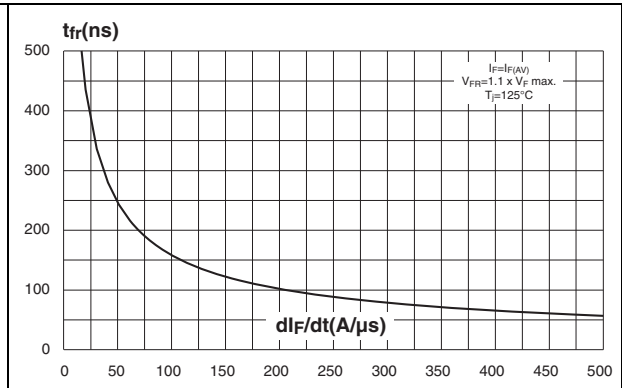

**Figure 11. Thermal resistance junction to ambient versus copper surface under tab (Epoxy printed circuit board FR4, copper thickness: 35 μm) ( $D^2\text{PAK}$ ).**

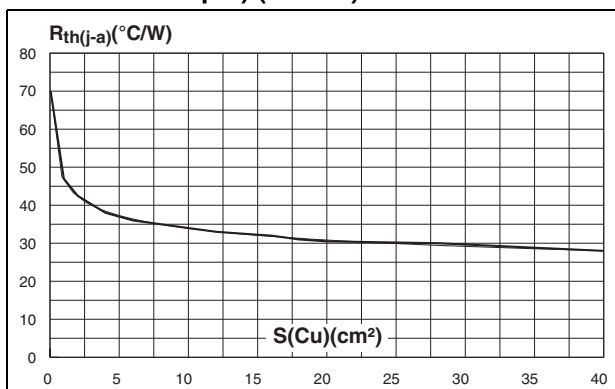

## 2 Package information

- Epoxy meets UL94, V0
- Cooling method: by conduction (C)
- Recommended torque value: 0.55 Nm
- Maximum torque value: 0.70 Nm

Table 5. I<sup>2</sup>PAK dimensions

Ref.	Dimensions			
	Millimeters		Inches	
	Min.	Max.	Min.	Max.
A	4.40	4.60	0.173	0.181
A1	2.40	2.72	0.094	0.107
b	0.61	0.88	0.024	0.035
b1	1.14	1.70	0.044	0.067
c	0.49	0.70	0.019	0.028
c2	1.23	1.32	0.048	0.052
D	8.95	9.35	0.352	0.368
e	2.40	2.70	0.094	0.106
e1	4.95	5.15	0.195	0.203
E	10	10.40	0.394	0.409
L	13	14	0.512	0.551
L1	3.50	3.93	0.138	0.155
L2	1.27	1.40	0.050	0.055

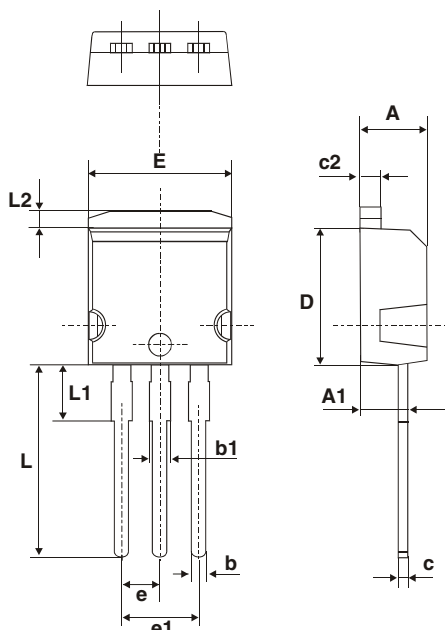

Table 6. D<sup>2</sup>PAK dimensions

Ref.	Dimensions					
	Millimeters			Inches		
	Min.	Typ.	Max.	Min.	Typ.	Max.
A	4.30		4.60	0.169		0.181
A1	2.49		2.69	0.098		0.106
A2	0.03		0.23	0.001		0.009
B	0.70		0.93	0.027		0.037
B2	1.25	1.40		0.048	0.055	
C	0.45		0.60	0.017		0.024
C2	1.21		1.36	0.047		0.054
D	8.95		9.35	0.352		0.368
E	10.00		10.28	0.393		0.405
G	4.88		5.28	0.192		0.208
L	15.00		15.85	0.590		0.624
L2	1.27		1.40	0.050		0.055
L3	1.40		1.75	0.055		0.069
R	0.40			0.016		
V2	0°		8°	0°		8°

Figure 12. Footprint (dimensions in millimeters)

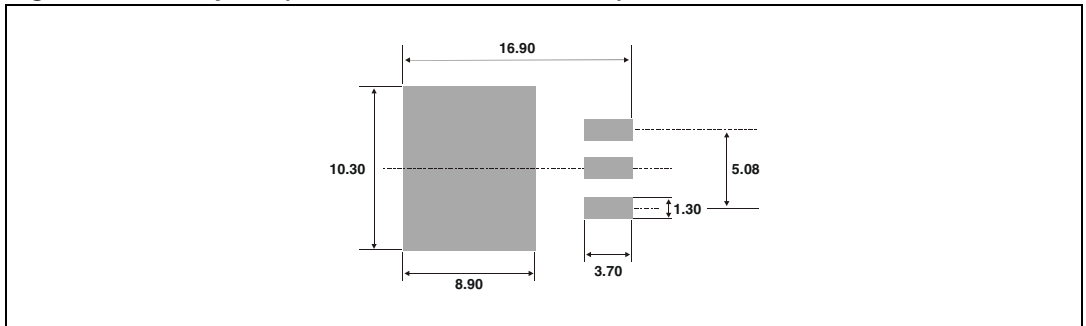

Table 7. TO-220AB dimensions

Ref.	Dimensions			
	Millimeters		Inches	
	Min.	Max.	Min.	Max.
A	4.40	4.60	0.173	0.181
C	1.23	1.32	0.048	0.051
D	2.40	2.72	0.094	0.107
E	0.49	0.70	0.019	0.027
F	0.61	0.88	0.024	0.034
F1	1.14	1.70	0.044	0.066
F2	1.14	1.70	0.044	0.066
G	4.95	5.15	0.194	0.202
G1	2.40	2.70	0.094	0.106
H2	10	10.40	0.393	0.409
L2	16.4 typ.		0.645 typ.	
L4	13	14	0.511	0.551
L5	2.65	2.95	0.104	0.116
L6	15.25	15.75	0.600	0.620
L7	6.20	6.60	0.244	0.259
L9	3.50	3.93	0.137	0.154
M	2.6 typ.		0.102 typ.	
Diam.	3.75	3.85	0.147	0.151



Table 8. TO-220FPAB dimensions

Ref.	Dimensions			
	Millimeters		Inches	
	Min.	Max.	Min.	Max.
A	4.4	4.6	0.173	0.181
B	2.5	2.7	0.098	0.106
D	2.5	2.75	0.098	0.108
E	0.45	0.70	0.018	0.027
F	0.75	1	0.030	0.039
F1	1.15	1.70	0.045	0.067
F2	1.15	1.70	0.045	0.067
G	4.95	5.20	0.195	0.205
G1	2.4	2.7	0.094	0.106
H	10	10.4	0.393	0.409
L2	16 Typ.		0.63 Typ.	
L3	28.6	30.6	1.126	1.205
L4	9.8	10.6	0.386	0.417
L5	2.9	3.6	0.114	0.142
L6	15.9	16.4	0.626	0.646
L7	9.00	9.30	0.354	0.366
Dia.	3.00	3.20	0.118	0.126

In order to meet environmental requirements, ST offers these devices in ECOPACK® packages. These packages have a Lead-free second level interconnect . The category of second level interconnect is marked on the package and on the inner box label, in compliance with JEDEC Standard JESD97. The maximum ratings related to soldering conditions are also marked on the inner box label. ECOPACK is an ST trademark. ECOPACK specifications are available at: [www.st.com](http://www.st.com).

### 3 Ordering information

Part Number	Marking	Package	Weight	Base qty	Delivery mode
STTH2003CT	STTH2003CT	TO-220AB	2.2 g	50	Tube
STTH2003CG	STTH2003CG	D <sup>2</sup> PAK	1.48 g	50	Tube
STTH2003CG-TR	STTH2003CG	D <sup>2</sup> PAK	1.48 g	500	Tape & reel
STTH2003CFP	STTH2003CFP	TO-220AB	2.08 g	50	Tube
STTH2003CR	STTH2003CR	I <sup>2</sup> PAK	1.49 g	50	Tube

### 4 Revision history

Date	Revision	Description of Changes
Aug-2003	7D	Last release.
26-Mar-2007	8	Removed ISOWATT package.

**Please Read Carefully:**

Information in this document is provided solely in connection with ST products. STMicroelectronics NV and its subsidiaries ("ST") reserve the right to make changes, corrections, modifications or improvements, to this document, and the products and services described herein at any time, without notice.

All ST products are sold pursuant to ST's terms and conditions of sale.

Purchasers are solely responsible for the choice, selection and use of the ST products and services described herein, and ST assumes no liability whatsoever relating to the choice, selection or use of the ST products and services described herein.

No license, express or implied, by estoppel or otherwise, to any intellectual property rights is granted under this document. If any part of this document refers to any third party products or services it shall not be deemed a license grant by ST for the use of such third party products or services, or any intellectual property contained therein or considered as a warranty covering the use in any manner whatsoever of such third party products or services or any intellectual property contained therein.

**UNLESS OTHERWISE SET FORTH IN ST'S TERMS AND CONDITIONS OF SALE ST DISCLAIMS ANY EXPRESS OR IMPLIED WARRANTY WITH RESPECT TO THE USE AND/OR SALE OF ST PRODUCTS INCLUDING WITHOUT LIMITATION IMPLIED WARRANTIES OF MERCHANTABILITY, FITNESS FOR A PARTICULAR PURPOSE (AND THEIR EQUIVALENTS UNDER THE LAWS OF ANY JURISDICTION), OR INFRINGEMENT OF ANY PATENT, COPYRIGHT OR OTHER INTELLECTUAL PROPERTY RIGHT.**

**UNLESS EXPRESSLY APPROVED IN WRITING BY AN AUTHORIZED ST REPRESENTATIVE, ST PRODUCTS ARE NOT RECOMMENDED, AUTHORIZED OR WARRANTED FOR USE IN MILITARY, AIR CRAFT, SPACE, LIFE SAVING, OR LIFE SUSTAINING APPLICATIONS, NOR IN PRODUCTS OR SYSTEMS WHERE FAILURE OR MALFUNCTION MAY RESULT IN PERSONAL INJURY, DEATH, OR SEVERE PROPERTY OR ENVIRONMENTAL DAMAGE. ST PRODUCTS WHICH ARE NOT SPECIFIED AS "AUTOMOTIVE GRADE" MAY ONLY BE USED IN AUTOMOTIVE APPLICATIONS AT USER'S OWN RISK.**

Resale of ST products with provisions different from the statements and/or technical features set forth in this document shall immediately void any warranty granted by ST for the ST product or service described herein and shall not create or extend in any manner whatsoever, any liability of ST.

ST and the ST logo are trademarks or registered trademarks of ST in various countries.

Information in this document supersedes and replaces all information previously supplied.

The ST logo is a registered trademark of STMicroelectronics. All other names are the property of their respective owners.

© 2007 STMicroelectronics - All rights reserved

STMicroelectronics group of companies

Australia - Belgium - Brazil - Canada - China - Czech Republic - Finland - France - Germany - Hong Kong - India - Israel - Italy - Japan - Malaysia - Malta - Morocco - Singapore - Spain - Sweden - Switzerland - United Kingdom - United States of America

[www.st.com](http://www.st.com)