

### Description

Dual center tap Schottky rectifiers suited for switched mode power supplies and high frequency DC to DC converters.

Packaged in TO-220AB, TO-220AB narrow leads, I<sup>2</sup>PAK and D<sup>2</sup>PAK, this device is intended for use in high frequency inverters.

**Table 1. Device summary**

|             |          |
|-------------|----------|
| $I_{F(AV)}$ | 2 x 10 A |
| $V_{RRM}$   | 60 V     |
| $T_j(max)$  | 150 °C   |
| $V_F(max)$  | 0.56 V   |

### Features

- Low forward voltage drop
- Negligible switching losses
- Low thermal resistance
- Avalanche capability specified

# 1 Characteristics

**Table 2. Absolute ratings (limiting values, per diode)**

| Symbol              | Parameter   |                                    | Value                   | Unit     |   |
|---------------------|---|------------------------------------|-------------------------|----------|---|
| V <sub>RRM</sub>    | Repetitive peak reverse voltage                       |                                    | 60                      | V        |   |
| I <sub>F(RMS)</sub> | Forward rms current                                   |                                    | 30                      | A        |   |
| I <sub>F(AV)</sub>  | Average forward current                               | T <sub>C</sub> = 140 °C<br>δ = 0.5 | Per diode<br>Per device | 10<br>20 | A |
| I <sub>FSM</sub>    | Surge non repetitive forward current                  | t <sub>p</sub> = 10 ms             | Sinusoidal              | 220      | A |
| I <sub>RRM</sub>    | Repetitive peak reverse current                       | t <sub>p</sub> = 2 μs square       | F=1 kHz                 | 1        | A |
| P <sub>ARM</sub>    | Repetitive peak avalanche power                       | t <sub>p</sub> = 1 μs              | T <sub>j</sub> = 25 °C  | 5800     | W |
| T <sub>stg</sub>    | Storage temperature range                             |                                    | -65 to + 175            | °C       |   |
| T <sub>j</sub>      | Maximum operating junction temperature <sup>(1)</sup> |                                    | 150                     | °C       |   |
| dV/dt               | Critical rate of rise reverse voltage                 |                                    | 10000                   | V/μs     |   |

1.  $\frac{dP_{tot}}{dT_j} < \frac{1}{R_{th(j-a)}}$  thermal runaway condition for a diode on its own heatsink

**Table 3. Thermal resistances**

| Symbol               | Parameter        |                    | Value       | Unit  |
|----------------------|------------------|--------------------|-------------|-------|
| R <sub>th(j-c)</sub> | Junction to case | Per diode<br>Total | 1.6<br>0.85 | ° C/W |
| R <sub>th(c)</sub>   | Coupling         |                    | 0.1         | ° C/W |

When the diodes 1 and 2 are used simultaneously:

$$\Delta T_j(\text{diode 1}) = P(\text{diode1}) \times R_{th(j-c)}(\text{Per diode}) + P(\text{diode2}) \times R_{th(c)}$$

**Table 4. Static electrical characteristics (per diode)**

| Symbol                        | Parameter               | Tests conditions        |                                   | Min. | Typ. | Max. | Unit |
|-------------------------------|-------------------------|-------------------------|-----------------------------------|------|------|------|------|
| I <sub>R</sub> <sup>(1)</sup> | Reverse leakage current | T <sub>j</sub> = 25 °C  | V <sub>R</sub> = V <sub>RRM</sub> |      |      | 350  | μA   |
|                               |                         | T <sub>j</sub> = 125 °C |                                   |      | 65   | 95   | mA   |
| V <sub>F</sub> <sup>(1)</sup> | Forward voltage drop    | T <sub>j</sub> = 25 °C  | I <sub>F</sub> = 10 A             |      |      | 0.6  | V    |
|                               |                         | T <sub>j</sub> = 125 °C | I <sub>F</sub> = 10 A             |      | 0.48 | 0.56 |      |
|                               |                         | T <sub>j</sub> = 25 °C  | I <sub>F</sub> = 20A              |      |      | 0.74 |      |
|                               |                         | T <sub>j</sub> = 125 °C | I <sub>F</sub> = 20A              |      | 0.62 | 0.7  |      |

1. Pulse test: t<sub>p</sub> = 380 μs, δ < 2%

To evaluate the conduction losses use the following equation:

$$P = 0.42 \times I_{F(AV)} + 0.014 \times I_{F(RMS)}^2$$

Figure 1. Average forward power dissipation versus average forward current (per diode)

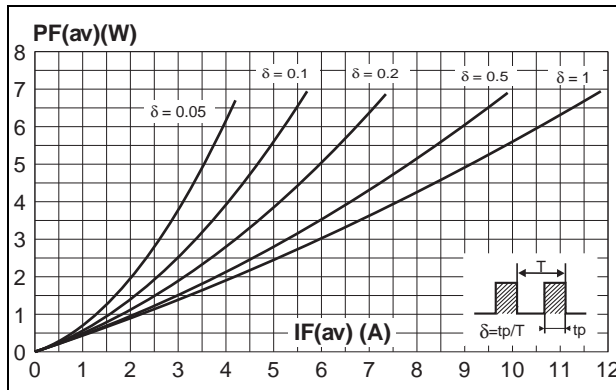

Figure 2. Average current versus ambient temperature ( $\delta = 0.5$ ) (per diode)

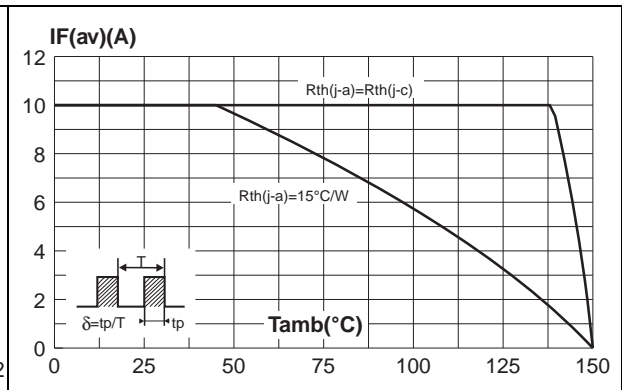

Figure 3. Normalized avalanche power derating versus pulse duration

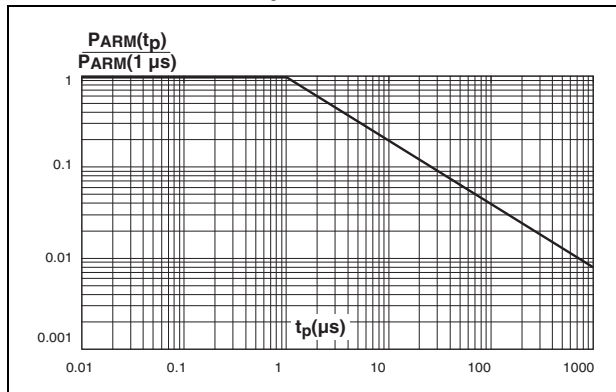

Figure 4. Normalized avalanche power derating versus junction temperature

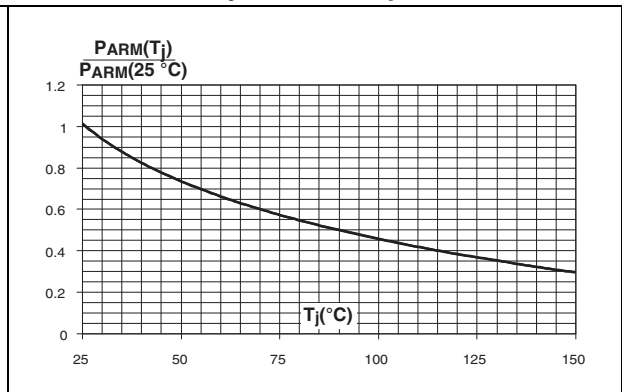

Figure 5. Non repetitive surge peak forward current versus overload duration (maximum values, per diode)

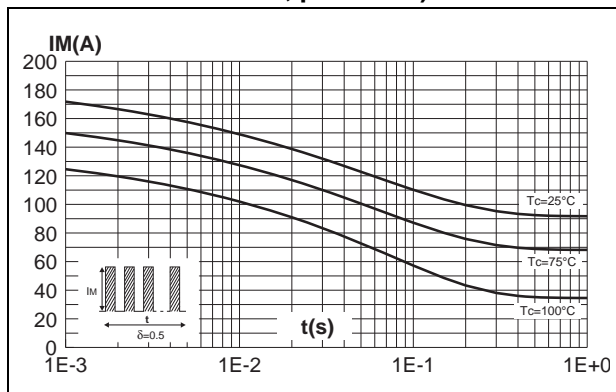

Figure 6. Relative variation of thermal transient impedance junction to case versus pulse duration

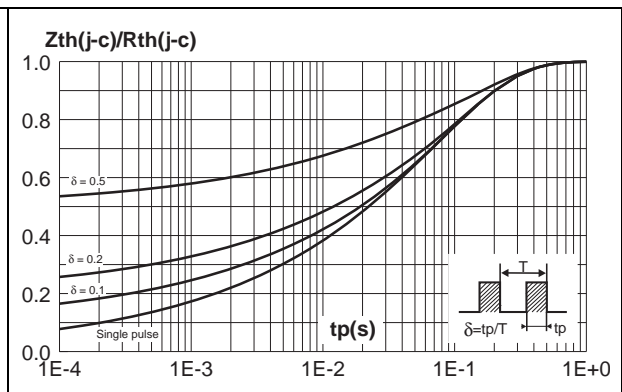

Figure 7. Reverse leakage current versus reverse voltage applied (typical values, per diode)

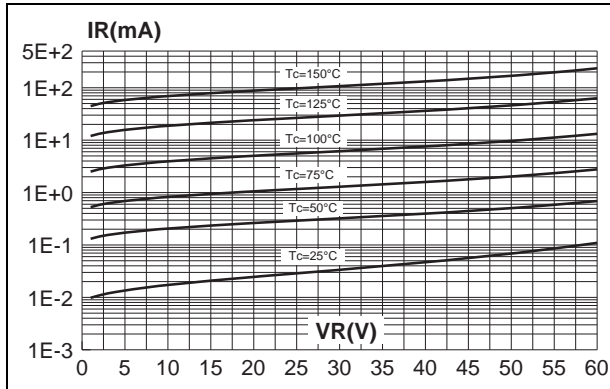

Figure 8. Junction capacitance versus reverse voltage applied (typical values, per diode)

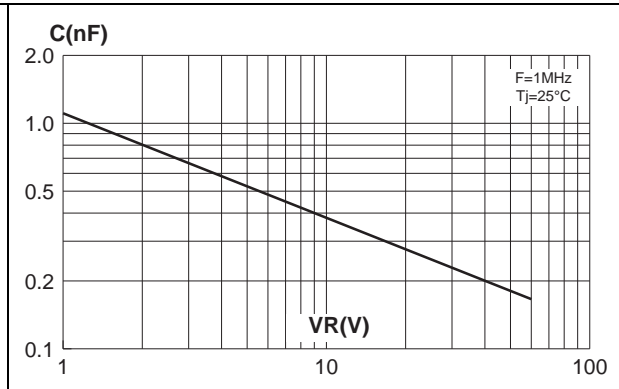
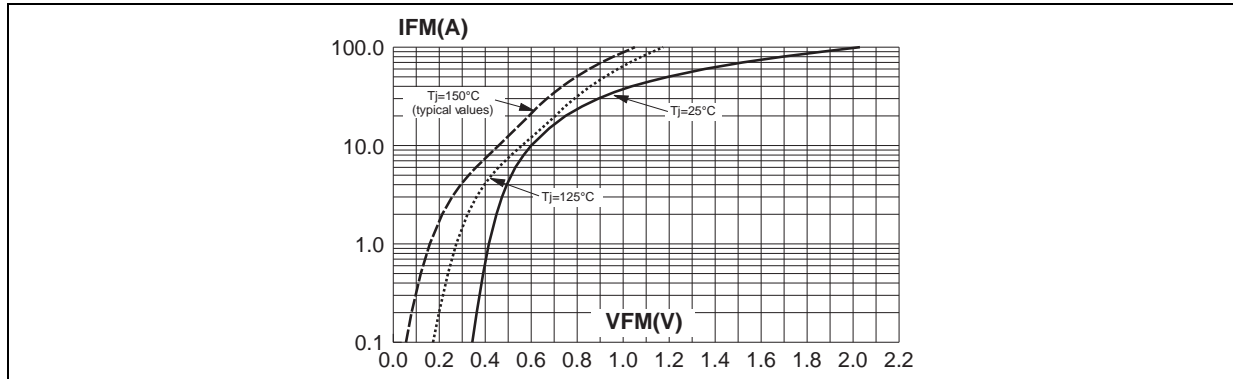

Figure 9. Forward voltage drop versus forward current (maximum values, per diode)



## 2 Package information

- Epoxy meets UL94,V0
- Cooling method: conduction
- Recommended torque value: 0.4 to 0.6 N·m

In order to meet environmental requirements, ST offers these devices in different grades of ECOPACK<sup>®</sup> packages, depending on their level of environmental compliance. ECOPACK<sup>®</sup> specifications, grade definitions and product status are available at: [www.st.com](http://www.st.com). ECOPACK<sup>®</sup> is an ST trademark.

**Table 5. TO-220AB narrow leads dimensions**

| Ref. | Dimensions  |      |       |        |      |       |
|------|-------------|------|-------|--------|------|-------|
|      | Millimeters |      |       | Inches |      |       |
|      | Min.        | Typ. | Max.  | Min.   | Typ. | Max.  |
| A    | 4.40        |      | 4.60  | 0.17   |      | 0.18  |
| b    | 0.61        |      | 0.88  | 0.024  |      | 0.034 |
| b1   | 0.95        |      | 1.20  | 0.037  |      | 0.047 |
| c    | 0.48        |      | 0.70  | 0.019  |      | 0.027 |
| D    | 15.25       |      | 15.75 | 0.60   |      | 0.62  |
| D1   | 1.27        |      |       | 0.05   |      |       |
| E    | 10.00       |      | 10.40 | 0.39   |      | 0.41  |
| e    | 2.40        |      | 2.70  | 0.094  |      | 0.106 |
| e1   | 4.95        |      | 5.15  | 0.19   |      | 0.20  |
| F    | 1.23        |      | 1.32  | 0.048  |      | 0.052 |
| H1   | 6.20        |      | 6.60  | 0.24   |      | 0.26  |
| J1   | 2.40        |      | 2.72  | 0.095  |      | 0.107 |
| L    | 13.00       |      | 14.00 | 0.51   |      | 0.55  |
| L1   | 2.60        |      | 2.90  | 0.102  |      | 0.114 |
| L20  | 15.40       |      |       | 0.61   |      |       |
| L30  | 28.90       |      |       | 1.14   |      |       |
| ∅P   | 3.75        |      | 3.85  | 0.147  |      | 0.151 |
| Q    | 2.65        |      | 2.95  | 0.104  |      | 0.116 |

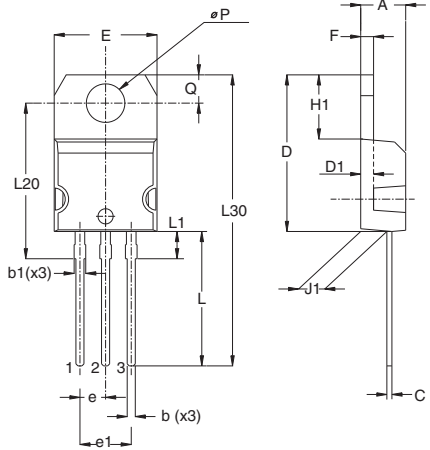

Devices in I<sup>2</sup>PAK with nickel-plated back frame must NOT be mounted by frame soldering like SMDs. Such devices are intended to be through-hole mounted ONLY and in no circumstances shall ST be held liable for any lack of performance or damage arising out of soldering of nickel-plated back frames.

Table 6. I<sup>2</sup>PAK dimensions

| Ref. | Dimensions  |       |        |       |
|------|-------------|-------|--------|-------|
|      | Millimeters |       | Inches |       |
|      | Min.        | Max.  | Min.   | Max.  |
| A    | 4.40        | 4.60  | 0.173  | 0.181 |
| A1   | 2.40        | 2.72  | 0.094  | 0.107 |
| b    | 0.61        | 0.88  | 0.024  | 0.035 |
| b1   | 1.14        | 1.70  | 0.044  | 0.067 |
| c    | 0.49        | 0.70  | 0.019  | 0.028 |
| c2   | 1.23        | 1.32  | 0.048  | 0.052 |
| D    | 8.95        | 9.35  | 0.352  | 0.368 |
| e    | 2.40        | 2.70  | 0.094  | 0.106 |
| e1   | 4.95        | 5.15  | 0.195  | 0.203 |
| E    | 10          | 10.40 | 0.394  | 0.409 |
| L    | 13          | 14    | 0.512  | 0.551 |
| L1   | 3.50        | 3.93  | 0.138  | 0.155 |
| L2   | 1.27        | 1.40  | 0.050  | 0.055 |

Table 7. D<sup>2</sup>PAK dimensions

| Ref. | Dimensions  |       |            |       |
|------|-------------|-------|------------|-------|
|      | Millimeters |       | Inches     |       |
|      | Min.        | Max.  | Min.       | Max.  |
| A    | 4.40        | 4.60  | 0.173      | 0.181 |
| A1   | 2.49        | 2.69  | 0.098      | 0.106 |
| A2   | 0.03        | 0.23  | 0.001      | 0.009 |
| B    | 0.70        | 0.93  | 0.027      | 0.037 |
| B2   | 1.14        | 1.70  | 0.045      | 0.067 |
| C    | 0.45        | 0.60  | 0.017      | 0.024 |
| C2   | 1.23        | 1.36  | 0.048      | 0.054 |
| D    | 8.95        | 9.35  | 0.352      | 0.368 |
| E    | 10.00       | 10.40 | 0.393      | 0.409 |
| G    | 4.88        | 5.28  | 0.192      | 0.208 |
| L    | 15.00       | 15.85 | 0.590      | 0.624 |
| L2   | 1.27        | 1.40  | 0.050      | 0.055 |
| L3   | 1.40        | 1.75  | 0.055      | 0.069 |
| M    | 2.40        | 3.20  | 0.094      | 0.126 |
| R    | 0.40 typ.   |       | 0.016 typ. |       |
| V2   | 0°          | 8°    | 0°         | 8°    |

\* FLAT ZONE NO LESSTHAN 2mm

Figure 10. Footprint (dimensions in mm)

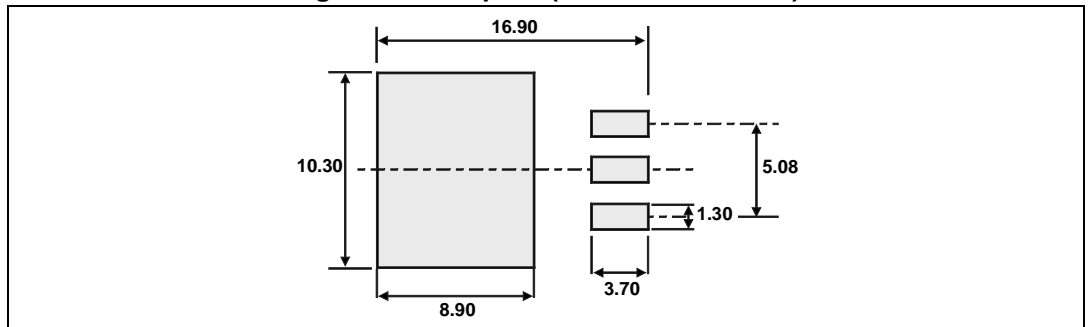
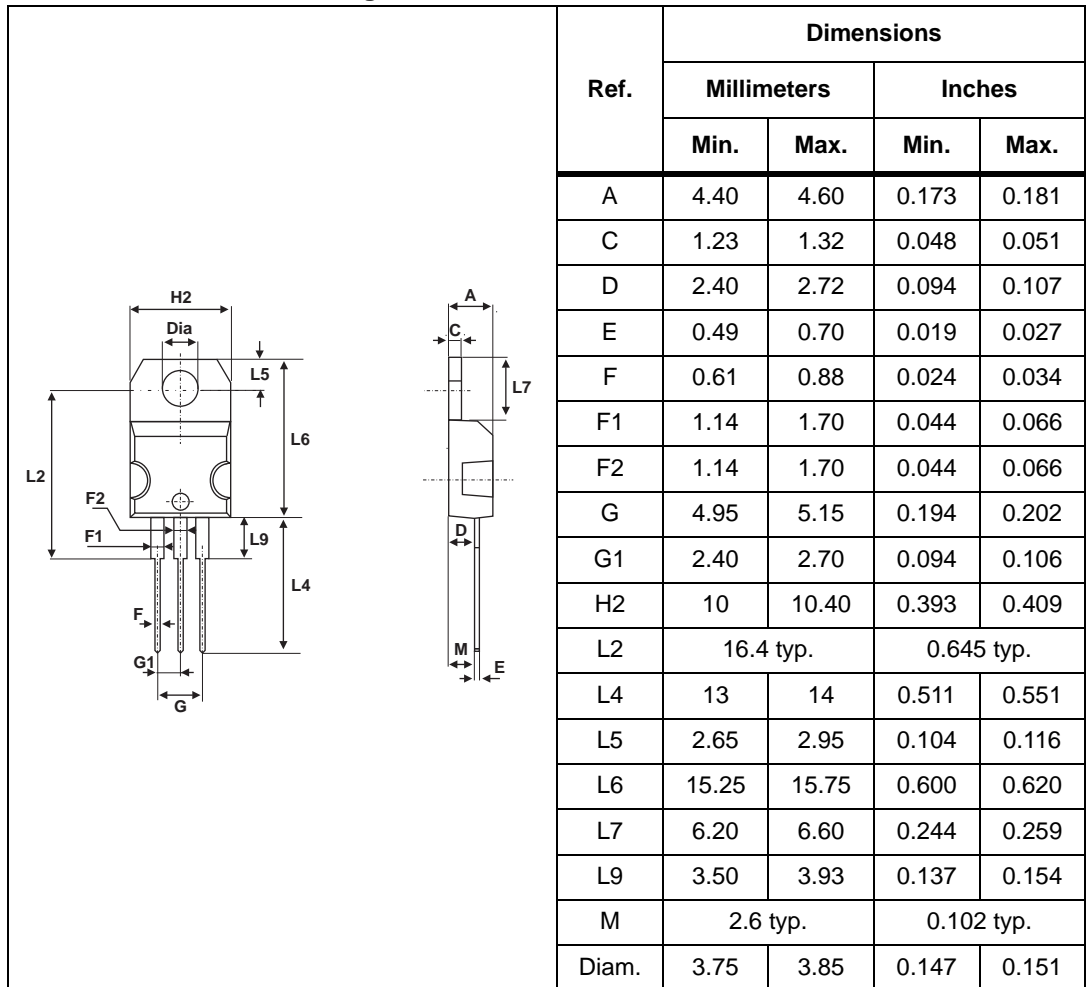

Figure 11. TO-220AB dimensions





### 3 Ordering information

**Table 8. Ordering information**

| Type           | Marking      | Package                  | Weight | Base qty | Delivery mode |
|----------------|--------------|--------------------------|--------|----------|---------------|
| STPS20L60CT    | STPS20L60CT  | TO-220AB                 | 2.2 g  | 50       | Tube          |
| STPS20L60CT    | STPS20L60CT  | TO-220AB                 | 2.2 g  | 1000     | Bulk          |
| STPS20L60CG    | STPS20L60CG  | D <sup>2</sup> PAK       | 1.48 g | 50       | Tube          |
| STPS20L60CG-TR | STPS20L60CG  | D <sup>2</sup> PAK       | 1.48 g | 1000     | Tape and reel |
| STPS20L60CR    | STPS20L60CR  | I <sup>2</sup> PAK       | 1.49 g | 50       | Tube          |
| STPS20L60CTN   | STPS20L60CTN | TO-220AB<br>narrow leads | 1.9 g  | 50       | Tube          |

### 4 Revision history

**Table 9. Document revision history**

| Date        | Revision | Changes                              |
|-------------|----------|--------------------------------------|
| Jul-2003    | 3C       | Previous release                     |
| 02-Aug-2013 | 4        | Added TO-220AB narrow leads package. |

**Please Read Carefully:**

Information in this document is provided solely in connection with ST products. STMicroelectronics NV and its subsidiaries ("ST") reserve the right to make changes, corrections, modifications or improvements, to this document, and the products and services described herein at any time, without notice.

All ST products are sold pursuant to ST's terms and conditions of sale.

Purchasers are solely responsible for the choice, selection and use of the ST products and services described herein, and ST assumes no liability whatsoever relating to the choice, selection or use of the ST products and services described herein.

No license, express or implied, by estoppel or otherwise, to any intellectual property rights is granted under this document. If any part of this document refers to any third party products or services it shall not be deemed a license grant by ST for the use of such third party products or services, or any intellectual property contained therein or considered as a warranty covering the use in any manner whatsoever of such third party products or services or any intellectual property contained therein.

**UNLESS OTHERWISE SET FORTH IN ST'S TERMS AND CONDITIONS OF SALE ST DISCLAIMS ANY EXPRESS OR IMPLIED WARRANTY WITH RESPECT TO THE USE AND/OR SALE OF ST PRODUCTS INCLUDING WITHOUT LIMITATION IMPLIED WARRANTIES OF MERCHANTABILITY, FITNESS FOR A PARTICULAR PURPOSE (AND THEIR EQUIVALENTS UNDER THE LAWS OF ANY JURISDICTION), OR INFRINGEMENT OF ANY PATENT, COPYRIGHT OR OTHER INTELLECTUAL PROPERTY RIGHT.**

**ST PRODUCTS ARE NOT AUTHORIZED FOR USE IN WEAPONS. NOR ARE ST PRODUCTS DESIGNED OR AUTHORIZED FOR USE IN: (A) SAFETY CRITICAL APPLICATIONS SUCH AS LIFE SUPPORTING, ACTIVE IMPLANTED DEVICES OR SYSTEMS WITH PRODUCT FUNCTIONAL SAFETY REQUIREMENTS; (B) AERONAUTIC APPLICATIONS; (C) AUTOMOTIVE APPLICATIONS OR ENVIRONMENTS, AND/OR (D) AEROSPACE APPLICATIONS OR ENVIRONMENTS. WHERE ST PRODUCTS ARE NOT DESIGNED FOR SUCH USE, THE PURCHASER SHALL USE PRODUCTS AT PURCHASER'S SOLE RISK, EVEN IF ST HAS BEEN INFORMED IN WRITING OF SUCH USAGE, UNLESS A PRODUCT IS EXPRESSLY DESIGNATED BY ST AS BEING INTENDED FOR "AUTOMOTIVE, AUTOMOTIVE SAFETY OR MEDICAL" INDUSTRY DOMAINS ACCORDING TO ST PRODUCT DESIGN SPECIFICATIONS. PRODUCTS FORMALLY ESCC, QML OR JAN QUALIFIED ARE DEEMED SUITABLE FOR USE IN AEROSPACE BY THE CORRESPONDING GOVERNMENTAL AGENCY.**

Resale of ST products with provisions different from the statements and/or technical features set forth in this document shall immediately void any warranty granted by ST for the ST product or service described herein and shall not create or extend in any manner whatsoever, any liability of ST.

ST and the ST logo are trademarks or registered trademarks of ST in various countries.

Information in this document supersedes and replaces all information previously supplied.

The ST logo is a registered trademark of STMicroelectronics. All other names are the property of their respective owners.

© 2013 STMicroelectronics - All rights reserved

STMicroelectronics group of companies

Australia - Belgium - Brazil - Canada - China - Czech Republic - Finland - France - Germany - Hong Kong - India - Israel - Italy - Japan - Malaysia - Malta - Morocco - Philippines - Singapore - Spain - Sweden - Switzerland - United Kingdom - United States of America

[www.st.com](http://www.st.com)