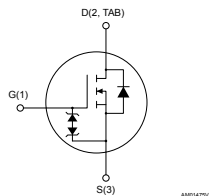
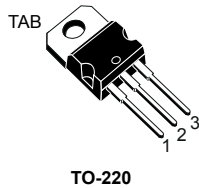


## N-channel 600 V, 115 mΩ typ., 25 A, MDmesh™ DM6 Power MOSFET in a TO-220 package



### Features

Order code	V <sub>DS</sub>	R <sub>DS(on)</sub> max.	I <sub>D</sub>
STP33N60DM6	600 V	128 mΩ	25 A

- Fast-recovery body diode
- Lower R<sub>DS(on)</sub> per area vs previous generation
- Low gate charge, input capacitance and resistance
- 100% avalanche tested
- Extremely high dv/dt ruggedness
- Zener-protected
- High-creepage package

### Applications

- Switching applications

### Description

This high-voltage N-channel Power MOSFET is part of the MDmesh DM6 fast-recovery diode series. Compared with the previous MDmesh fast generation, DM6 combines very low recovery charge (Q<sub>rr</sub>), recovery time (t<sub>rr</sub>) and excellent improvement in R<sub>DS(on)</sub> per area with one of the most effective switching behaviors available in the market for the most demanding high-efficiency bridge topologies and ZVS phase-shift converters.

#### Product status link

[STP33N60DM6](#)

#### Product summary

<b>Order code</b>	STP33N60DM6
<b>Marking</b>	33N60DM6
<b>Package</b>	TO-220
<b>Packing</b>	Tube

# 1 Electrical ratings

**Table 1. Absolute maximum ratings**

Symbol	Parameter	Value	Unit
$V_{GS}$	Gate-source voltage	$\pm 25$	V
$I_D$	Drain current (continuous) at $T_C = 25\text{ }^\circ\text{C}$	25	A
	Drain current (continuous) at $T_C = 100\text{ }^\circ\text{C}$	16	A
$I_{DM}^{(1)}$	Drain current (pulsed)	80	A
$P_{TOT}$	Total power dissipation at $T_C = 25\text{ }^\circ\text{C}$	190	W
$dv/dt^{(2)}$	Peak diode recovery voltage slope	100	V/ns
$di/dt^{(2)}$	Peak diode recovery current slope	1000	A/ $\mu\text{s}$
$dv/dt^{(3)}$	MOSFET $dv/dt$ ruggedness	100	V/ns
$T_{stg}$	Storage temperature range	-55 to 150	$^\circ\text{C}$
$T_j$	Operating junction temperature range		

1. Pulse width is limited by safe operating area.
2.  $I_{SD} \leq 25\text{ A}$ ,  $V_{DS(peak)} < V_{(BR)DSS}$ ,  $V_{DD} = 400\text{ V}$
3.  $V_{DS} \leq 480\text{ V}$

**Table 2. Thermal data**

Symbol	Parameter	Value	Unit
$R_{thj-case}$	Thermal resistance junction-case	0.66	$^\circ\text{C/W}$
$R_{thj-amb}$	Thermal resistance junction-ambient	62.5	$^\circ\text{C/W}$

**Table 3. Avalanche characteristics**

Symbol	Parameter	Value	Unit
$I_{AR}$	Avalanche current, repetitive or not repetitive (pulse width limited by $T_{jmax}$ )	4	A
$E_{AS}$	Single pulse avalanche energy (starting $T_j = 25\text{ }^\circ\text{C}$ , $I_D = I_{AR}$ , $V_{DD} = 50\text{ V}$ )	360	mJ

## 2 Electrical characteristics

$T_C = 25\text{ °C}$  unless otherwise specified

**Table 4. On/off states**

Symbol	Parameter	Test conditions	Min.	Typ.	Max.	Unit
$V_{(BR)DSS}$	Drain-source breakdown voltage	$V_{GS} = 0\text{ V}$ , $I_D = 1\text{ mA}$	600			V
$I_{DSS}$	Zero gate voltage drain current	$V_{GS} = 0\text{ V}$ , $V_{DS} = 600\text{ V}$			1	$\mu\text{A}$
		$V_{GS} = 0\text{ V}$ , $V_{DS} = 600\text{ V}$ , $T_C = 125\text{ °C}^{(1)}$			100	$\mu\text{A}$
$I_{GSS}$	Gate-body leakage current	$V_{DS} = 0\text{ V}$ , $V_{GS} = \pm 25\text{ V}$			$\pm 5$	$\mu\text{A}$
$V_{GS(th)}$	Gate threshold voltage	$V_{DS} = V_{GS}$ , $I_D = 250\text{ }\mu\text{A}$	3.25	4	4.75	V
$R_{DS(on)}$	Static drain-source on-resistance	$V_{GS} = 10\text{ V}$ , $I_D = 12.5\text{ A}$		115	128	$\text{m}\Omega$

1. Defined by design, not subject to production test.

**Table 5. Dynamic**

Symbol	Parameter	Test conditions	Min.	Typ.	Max.	Unit
$C_{iss}$	Input capacitance	$V_{DS} = 100\text{ V}$ , $f = 1\text{ MHz}$ , $V_{GS} = 0\text{ V}$	-	1500	-	$\text{pF}$
$C_{oss}$	Output capacitance		-	115	-	$\text{pF}$
$C_{riss}$	Reverse transfer capacitance		-	3	-	$\text{pF}$
$C_{oss\text{ eq.}}^{(1)}$	Equivalent output capacitance	$V_{DS} = 0\text{ to }480\text{ V}$ , $V_{GS} = 0\text{ V}$	-	225	-	$\text{pF}$
$R_G$	Intrinsic gate resistance	$f = 1\text{ MHz}$ , $I_D = 0\text{ A}$	-	1.8	-	$\Omega$
$Q_g$	Total gate charge	$V_{DD} = 480\text{ V}$ , $I_D = 25\text{ A}$ , $V_{GS} = 0\text{ to }10\text{ V}$ (see Figure 14. Test circuit for gate charge behavior)	-	35	-	$\text{nC}$
$Q_{gs}$	Gate-source charge		-	10	-	$\text{nC}$
$Q_{gd}$	Gate-drain charge		-	15	-	$\text{nC}$

1.  $C_{oss\text{ eq.}}$  is defined as a constant equivalent capacitance giving the same charging time as  $C_{oss}$  when  $V_{DS}$  increases from 0 to 80%  $V_{DSS}$ .

**Table 6. Switching times**

Symbol	Parameter	Test conditions	Min.	Typ.	Max.	Unit
$t_{d(on)}$	Turn-on delay time	$V_{DD} = 300\text{ V}$ , $I_D = 12.5\text{ A}$ , $R_G = 4.7\text{ }\Omega$ , $V_{GS} = 10\text{ V}$	-	14	-	ns
$t_r$	Rise time		-	9	-	ns
$t_{d(off)}$	Turn-off delay time	(see Figure 13. Test circuit for resistive load switching times and Figure 18. Switching time waveform)	-	7	-	ns
$t_f$	Fall time		-	35	-	ns

**Table 7. Source drain diode**

Symbol	Parameter	Test conditions	Min.	Typ.	Max.	Unit
$I_{SD}$	Source-drain current		-		25	A
$I_{SDM}^{(1)}$	Source-drain current (pulsed)		-		80	A
$V_{SD}^{(2)}$	Forward on voltage	$V_{GS} = 0\text{ V}$ , $I_{SD} = 25\text{ A}$	-		1.6	V
$t_{rr}$	Reverse recovery time	$I_{SD} = 25\text{ A}$ , $di/dt = 100\text{ A}/\mu\text{s}$ , $V_{DD} = 60\text{ V}$	-	105		ns
$Q_{rr}$	Reverse recovery charge		-	0.47		$\mu\text{C}$
$I_{RRM}$	Reverse recovery current	(see Figure 15. Test circuit for inductive load switching and diode recovery times)	-	9		A
$t_{rr}$	Reverse recovery time	$I_{SD} = 25\text{ A}$ , $di/dt = 100\text{ A}/\mu\text{s}$ , $V_{DD} = 60\text{ V}$ , $T_j = 150\text{ }^\circ\text{C}$	-	210		ns
$Q_{rr}$	Reverse recovery charge		-	1.68		$\mu\text{C}$
$I_{RRM}$	Reverse recovery current		(see Figure 15. Test circuit for inductive load switching and diode recovery times)	-	16	

1. Pulse width is limited by safe operating area.
2. Pulsed: pulse duration = 300  $\mu\text{s}$ , duty cycle 1.5 %.

## 2.1 Electrical characteristics (curves)

Figure 1. Safe operating area

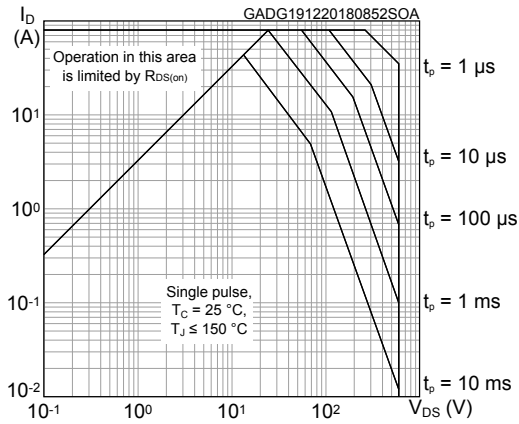


Figure 2. Normalized thermal impedance

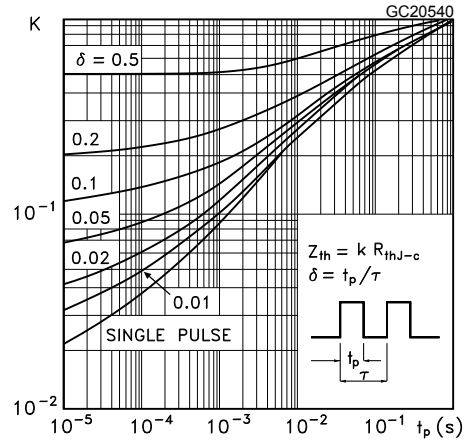


Figure 3. Output characteristics

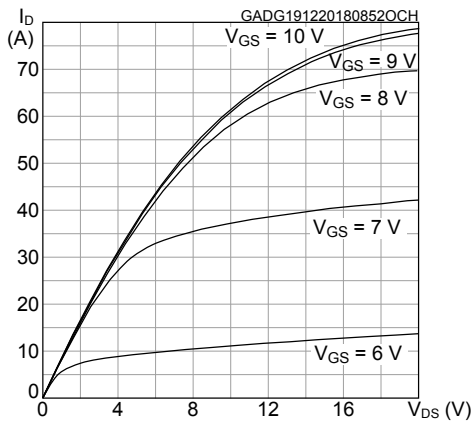


Figure 4. Transfer characteristics

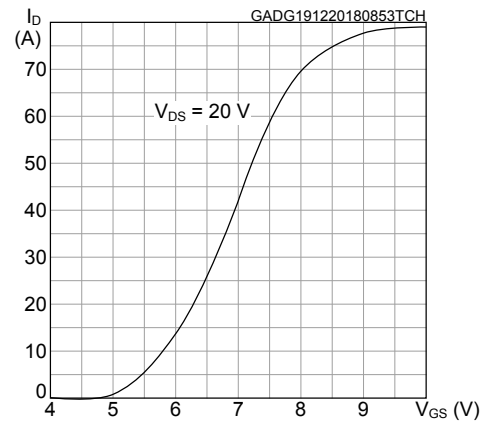


Figure 5. Gate charge vs gate-source voltage

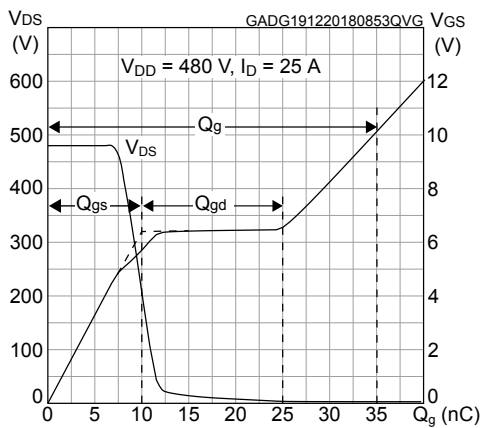
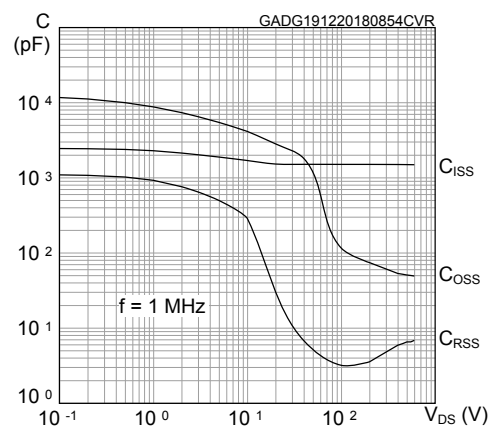
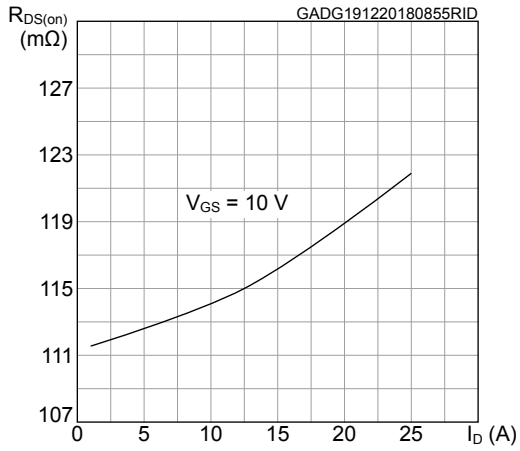


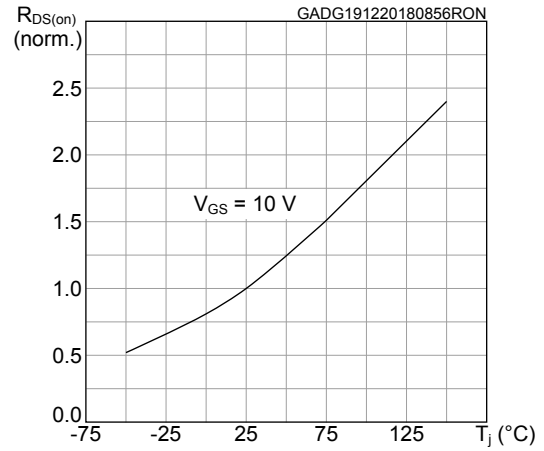
Figure 6. Capacitance variations



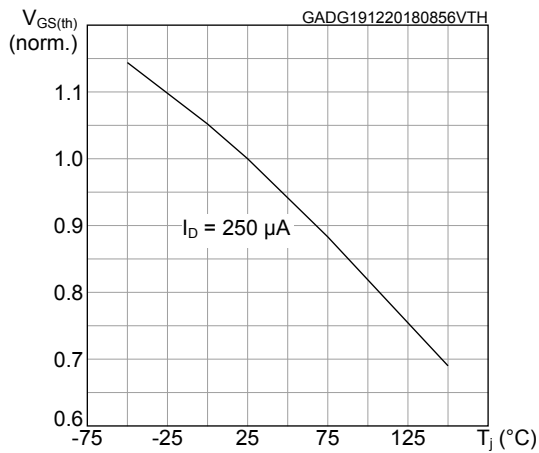
**Figure 7. Static drain-source on-resistance**



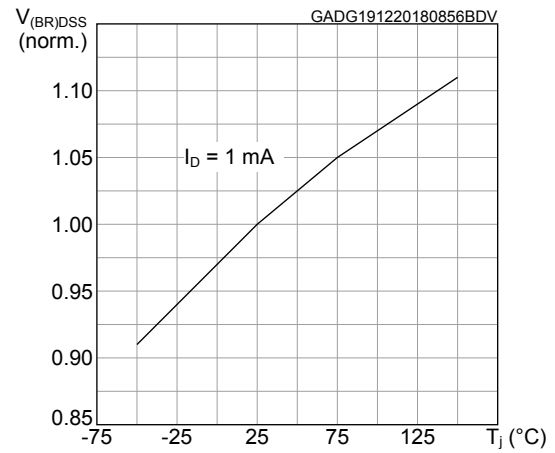
**Figure 8. Normalized on-resistance vs temperature**



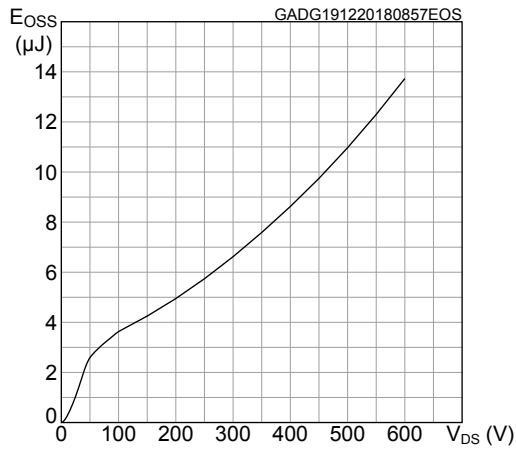
**Figure 9. Normalized gate threshold voltage vs temperature**



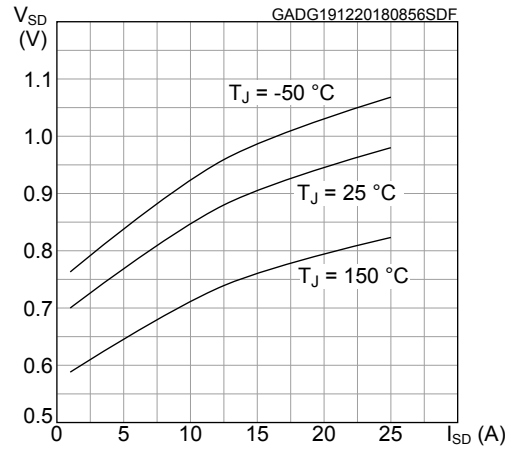
**Figure 10. Normalized  $V_{(BR)DSS}$  vs temperature**



**Figure 11. Output capacitance stored energy**

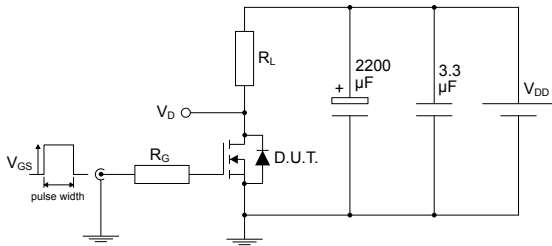


**Figure 12. Source-drain diode forward characteristics**



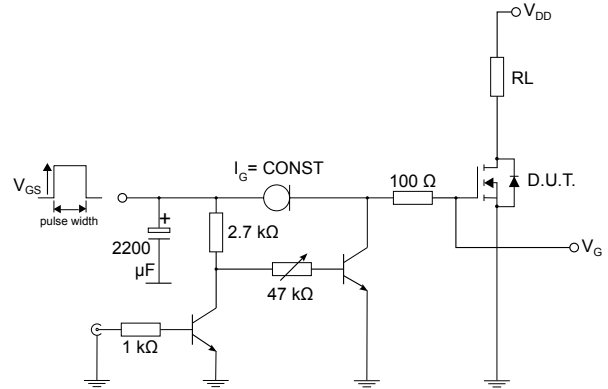
### 3 Test circuits

Figure 13. Test circuit for resistive load switching times



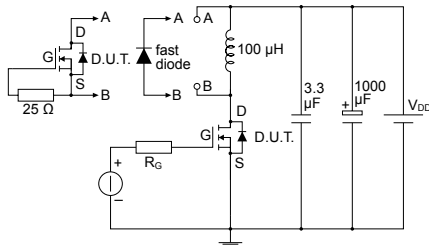
AM01468v1

Figure 14. Test circuit for gate charge behavior



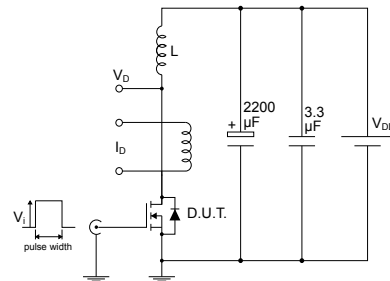
AM01469v10

Figure 15. Test circuit for inductive load switching and diode recovery times



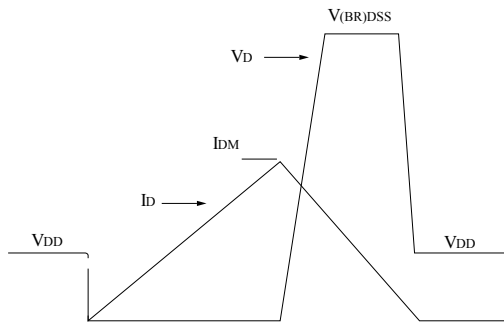
AM01470v1

Figure 16. Unclamped inductive load test circuit



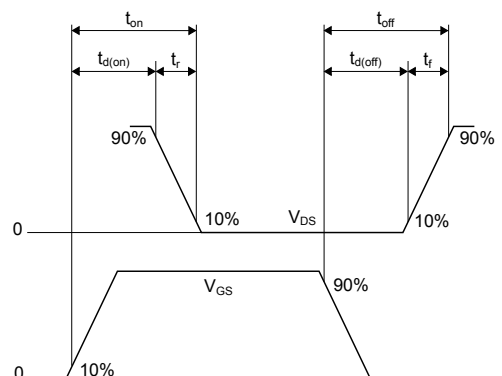
AM01471v1

Figure 17. Unclamped inductive waveform



AM01472v1

Figure 18. Switching time waveform



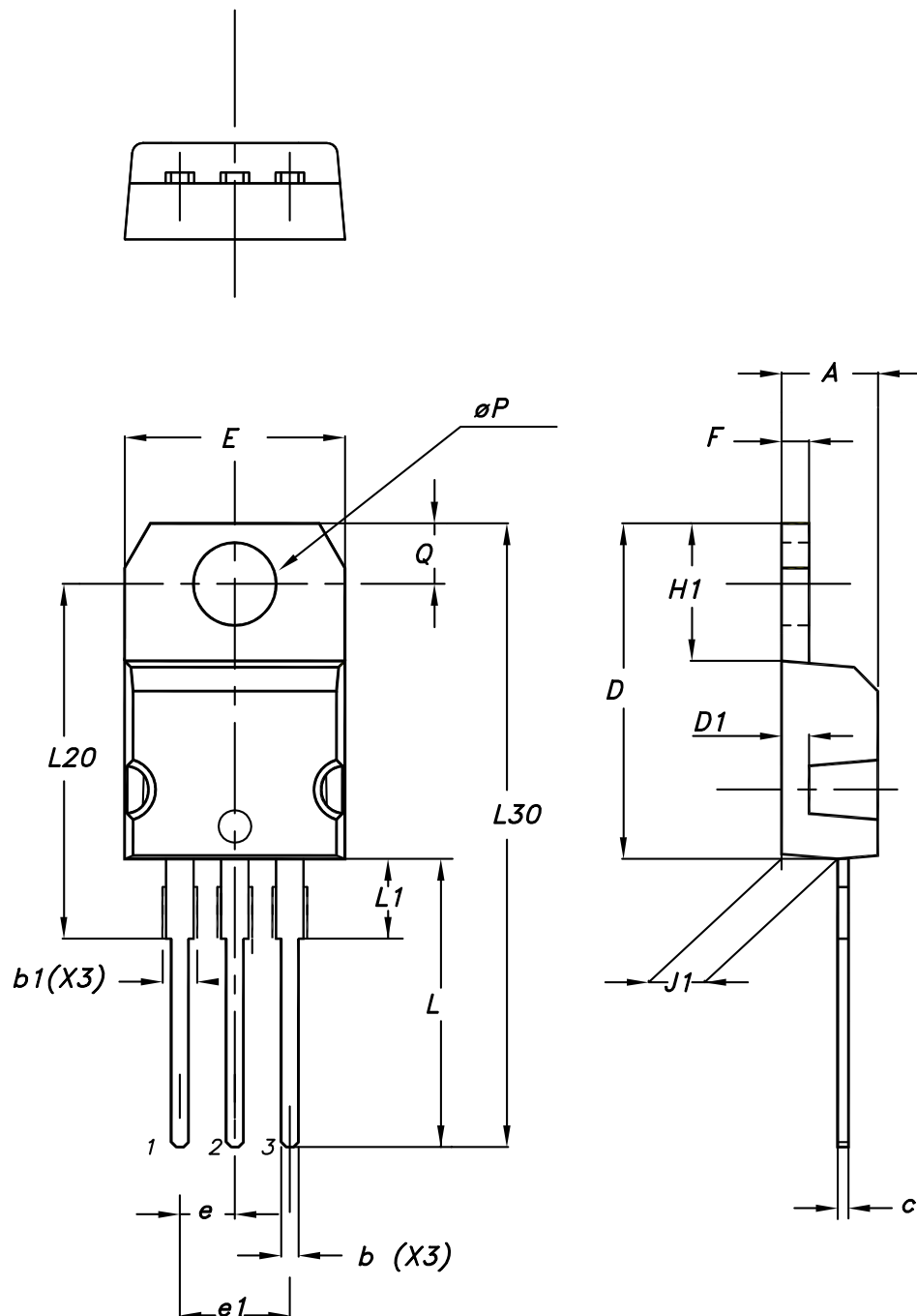
AM01473v1

## 4 Package information

In order to meet environmental requirements, ST offers these devices in different grades of **ECOPACK** packages, depending on their level of environmental compliance. ECOPACK specifications, grade definitions and product status are available at: [www.st.com](http://www.st.com). ECOPACK is an ST trademark.

### 4.1 TO-220 type A package information

Figure 19. TO-220 type A package outline



0015988\_typeA\_Rev\_23



**Table 8. TO-220 type A package mechanical data**

Dim.	mm		
	Min.	Typ.	Max.
A	4.40		4.60
b	0.61		0.88
b1	1.14		1.55
c	0.48		0.70
D	15.25		15.75
D1		1.27	
E	10.00		10.40
e	2.40		2.70
e1	4.95		5.15
F	1.23		1.32
H1	6.20		6.60
J1	2.40		2.72
L	13.00		14.00
L1	3.50		3.93
L20		16.40	
L30		28.90	
øP	3.75		3.85
Q	2.65		2.95
Slug flatness		0.03	0.10

## Revision history

**Table 9. Document revision history**

Date	Version	Changes
10-Jan-2019	1	First release.
25-Jan-2019	2	Updated ID current values in front page and Table 1. Absolute maximum ratings.
18-May-2020	3	Updated <a href="#">Table 1. Absolute maximum ratings</a> and <a href="#">Table 7. Source drain diode</a> .

## Contents

<b>1</b>	<b>Electrical ratings</b> .....	<b>2</b>
<b>2</b>	<b>Electrical characteristics</b> .....	<b>3</b>
<b>2.1</b>	<b>Electrical characteristics (curves)</b> .....	<b>5</b>
<b>3</b>	<b>Test circuits</b> .....	<b>7</b>
<b>4</b>	<b>Package information</b> .....	<b>8</b>
<b>4.1</b>	<b>TO-220 type A package information</b> .....	<b>8</b>
	<b>Revision history</b> .....	<b>10</b>

**IMPORTANT NOTICE – PLEASE READ CAREFULLY**

STMicroelectronics NV and its subsidiaries (“ST”) reserve the right to make changes, corrections, enhancements, modifications, and improvements to ST products and/or to this document at any time without notice. Purchasers should obtain the latest relevant information on ST products before placing orders. ST products are sold pursuant to ST’s terms and conditions of sale in place at the time of order acknowledgement.

Purchasers are solely responsible for the choice, selection, and use of ST products and ST assumes no liability for application assistance or the design of Purchasers’ products.

No license, express or implied, to any intellectual property right is granted by ST herein.

Resale of ST products with provisions different from the information set forth herein shall void any warranty granted by ST for such product.

ST and the ST logo are trademarks of ST. For additional information about ST trademarks, please refer to [www.st.com/trademarks](http://www.st.com/trademarks). All other product or service names are the property of their respective owners.

Information in this document supersedes and replaces information previously supplied in any prior versions of this document.

© 2020 STMicroelectronics – All rights reserved