

N-channel 600 V, 1.5 Ω , 2.2 A MDmesh™ II Power MOSFET in a PowerFLAT™ 3.3 x 3.3 HV package

Datasheet - production data

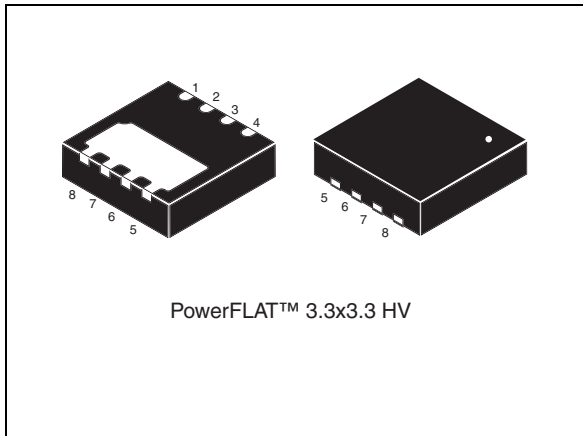
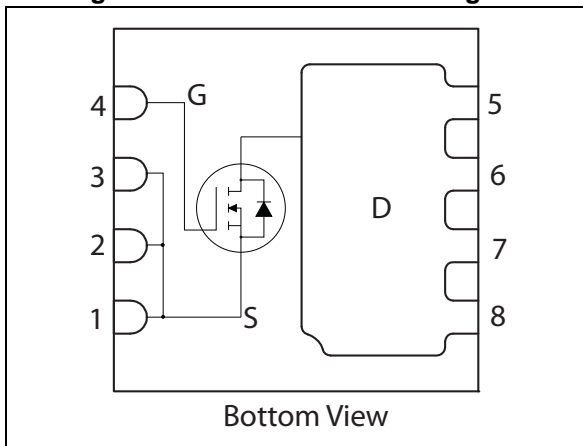

Figure 1. Internal schematic diagram



Features

Order code	$R_{DS(on)}$ max.	I_D
STL3NM60N	1.8 Ω	2.2 A

- 100% avalanche tested
- Low input capacitance and gate charge
- Low gate input resistance

Application

- Switching applications

Description

This device is an N-channel Power MOSFET developed using the second generation of MDmesh™ technology. This revolutionary Power MOSFET associates a vertical structure to the company's strip layout to yield one of the world's lowest on-resistance and gate charge. It is therefore suitable for the most demanding high efficiency converters.

Table 1. Device summary

Order code	Marking	Package	Packaging
STL3NM60N	3NM60N	PowerFLAT™ 3.3 x 3.3 HV	Tape and reel

Contents

1	Electrical ratings	3
2	Electrical characteristics	4
	2.1 Electrical characteristics (curves)	6
3	Test circuits	8
4	Package mechanical data	9
5	Revision history	12

1 Electrical ratings

Table 2. Absolute maximum ratings

Symbol	Parameter	Value	Unit
V_{DS}	Drain-source voltage	600	V
V_{GS}	Gate-source voltage	± 25	V
$I_D^{(1)}$	Drain current (continuous) at $T_C = 25\text{ }^\circ\text{C}$	2.2	A
$I_D^{(1)}$	Drain current (continuous) at $T_C=100\text{ }^\circ\text{C}$	1.7	A
$I_D^{(2)}$	Drain current (continuous) at $T_{amb} = 25\text{ }^\circ\text{C}$	0.65	A
$I_D^{(2)}$	Drain current (continuous) at $T_{amb}=100\text{ }^\circ\text{C}$	0.5	A
$I_{DM}^{(2)(3)}$	Drain current (pulsed)	2.6	A
$P_{TOT}^{(2)}$	Total dissipation at $T_{amb} = 25\text{ }^\circ\text{C}$	2	W
$P_{TOT}^{(1)}$	Total dissipation at $T_C = 25\text{ }^\circ\text{C}$	22	W
I_{AS}	Avalanche current, repetitive or not-repetitive ⁽³⁾	1	A
E_{AS}	Single pulse avalanche energy ⁽⁴⁾	119	mJ
	Derating factor ⁽²⁾	0.016	W/°C
$dv/dt^{(5)}$	Peak diode recovery voltage slope	15	V/ns
T_J T_{stg}	Operating junction temperature storage temperature	-55 to 150	°C

1. The value is rated according $R_{thj-case}$.
2. When mounted on FR-4 board of 1inch², 2oz Cu, $t < 10$ sec
3. Pulse width limited by T_{jmax}
4. Starting $T_j = 25\text{ }^\circ\text{C}$, $I_D = I_{AS}$, $V_{DD} = 50\text{V}$
5. $I_{SD} \leq 2.2\text{ A}$, $dv/dt \leq 400\text{ A}/\mu\text{s}$, $V_{DS\ peak} \leq V_{(BR)DSS}$, $V_{DD} = 80\% V_{(BR)DSS}$

Table 3. Thermal resistance

Symbol	Parameter	Value	Unit
$R_{thj-case}$	Thermal resistance junction-case max.	5.6	°C/W
$R_{thj-amb}^{(1)}$	Thermal resistance junction-amb max.	62.5	°C/W

1. When mounted on FR-4 board of 1inch², 2oz Cu, $t < 10$ sec.

2 Electrical characteristics

($T_{CASE}=25^{\circ}C$ unless otherwise specified)

Table 4. On/off states

Symbol	Parameter	Test conditions	Min.	Typ.	Max.	Unit
$V_{(BR)DSS}$	Drain-source breakdown voltage ($V_{GS}=0$)	$I_D = 1 \text{ mA}$	600			V
I_{DSS}	Zero gate voltage drain current ($V_{GS}=0$)	$V_{DS} = 600 \text{ V}$,			1	μA
		$V_{DS} = 600 \text{ V}$, $T_C = 125^{\circ}C$			100	μA
I_{GSS}	Gate body leakage current ($V_{DS}=0$)	$V_{GS} = \pm 25 \text{ V}$			± 100	nA
$V_{GS(th)}$	Gate threshold voltage	$V_{DS} = V_{GS}$, $I_D = 250 \mu\text{A}$	2	3	4	V
$R_{DS(on)}$	Static drain-source on resistance	$V_{GS} = 10 \text{ V}$, $I_D = 1 \text{ A}$		1.5	1.8	Ω

Table 5. Dynamic

Symbol	Parameter	Test conditions	Min.	Typ.	Max.	Unit
C_{iss}	Input capacitance	$V_{DS} = 50\text{V}$, $f=1 \text{ MHz}$, $V_{GS}=0$	-	188	-	pF
C_{oss}	Output capacitance		-	13	-	pF
C_{rss}	Reverse transfer capacitance		-	1.1	-	pF
$C_{oss \text{ eq.}}^{(1)}$	Output equivalent capacitance	$V_{GS} = 0$, $V_{DS} = 0$ to 480 V	-	100	-	pF
R_g	Gate input resistance	$f = 1 \text{ MHz}$ gate DC bias=0 test signal level = 20 mV open drain	-	6	-	Ω
Q_g	Total gate charge	$V_{DD} = 480 \text{ V}$, $I_D = 2.2 \text{ A}$	-	9.5	-	nC
Q_{gs}	Gate-source charge	$V_{GS} = 10 \text{ V}$	-	1.6	-	nC
Q_{gd}	Gate-drain charge	(see Figure 15)	-	5.3	-	nC

1. $C_{oss \text{ eq.}}$ is defined as a constant equivalent capacitance giving the same charging time as C_{oss} when V_{DS} increases from 0 to 80% V_{DSS}

Table 6. Switching times

Symbol	Parameter	Test conditions	Min.	Typ.	Max.	Unit
$t_{d(on)}$	Turn-on delay time	$V_{DD} = 300\text{ V}$, $I_D = 1.1\text{ A}$, $R_G = 4.7\ \Omega$, $V_{GS} = 10\text{ V}$ (see Figure 14)	-	8.6	-	ns
t_r	Rise time		-	6.2	-	ns
$t_{d(off)}$	Turn-off delay time		-	20.8	-	ns
t_f	Fall time		-	20	-	ns

Table 7. Source drain diode

Symbol	Parameter	Test conditions	Min	Typ.	Max	Unit
I_{SD}	Source-drain current		-		2.2	A
$I_{SDM}^{(1)}$	Source-drain current (pulsed)		-		8.8	A
$V_{SD}^{(2)}$	Forward on voltage	$I_{SD} = 2.2\text{ A}$, $V_{GS} = 0$	-		1.6	V
t_{rr}	Reverse recovery time	$I_{SD} = 2.2\text{ A}$, $di/dt = 100\text{ A}/\mu\text{s}$, $V_{DD} = 60\text{ V}$ (see Figure 16)	-	168		ns
Q_{rr}	Reverse recovery charge		-	672		nC
I_{RRM}	Reverse recovery current		-	8		A
t_{rr}	Reverse recovery time	$I_{SD} = 2.2\text{ A}$, $di/dt = 100\text{ A}/\mu\text{s}$, $V_{DD} = 60\text{ V}$, $T_j = 150\text{ }^\circ\text{C}$ (see Figure 16)	-	2.3		ns
Q_{rr}	Reverse recovery charge		-	913		nC
I_{RRM}	Reverse recovery current		-	9		A

1. Pulse width limited by safe operating area.
2. Pulsed: pulse duration = 300 μs , duty cycle 1.5%

2.1 Electrical characteristics (curves)

Figure 2. Safe operating area

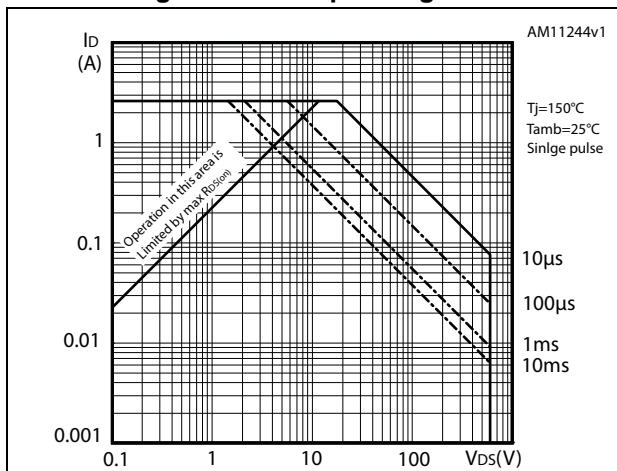

Figure 3. Thermal impedance

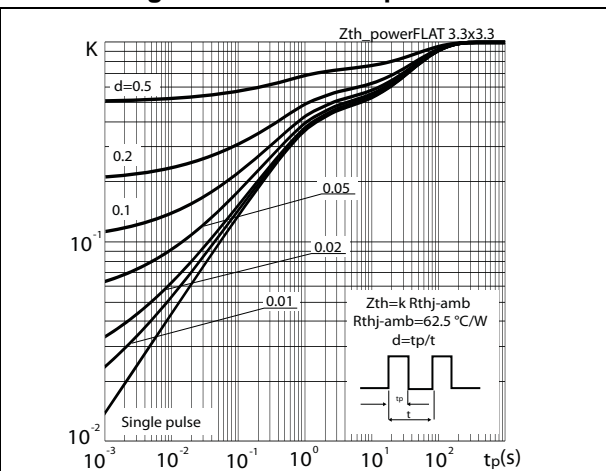

Figure 4. Output characteristics

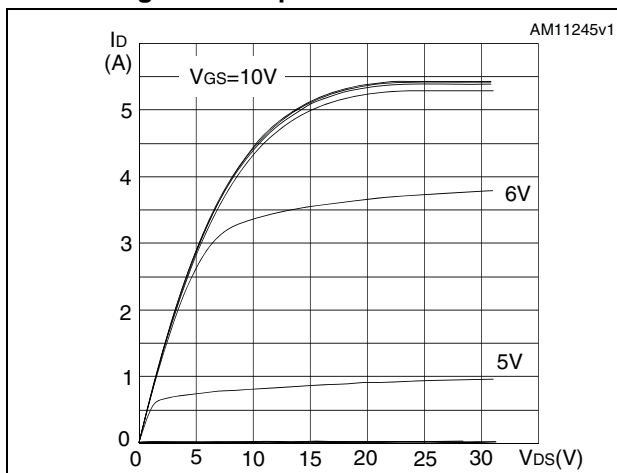

Figure 5. Transfer characteristics

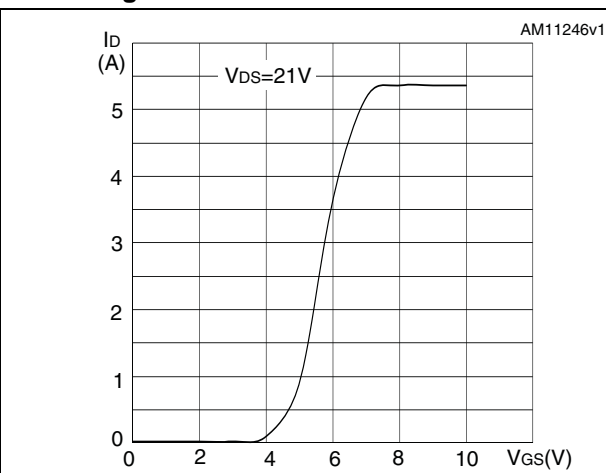

Figure 6. Gate charge vs gate-source voltage

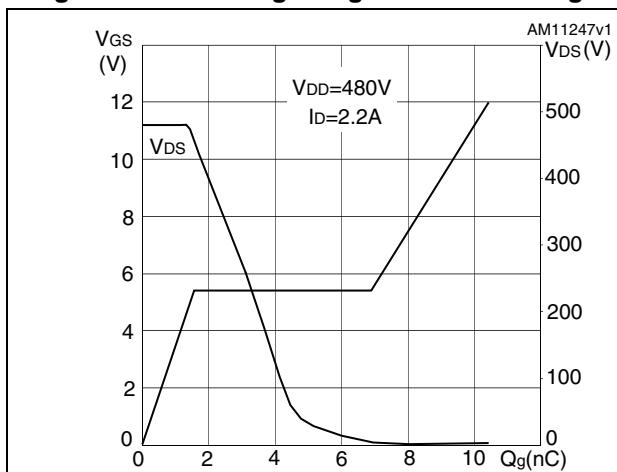

Figure 7. Static drain-source on resistance

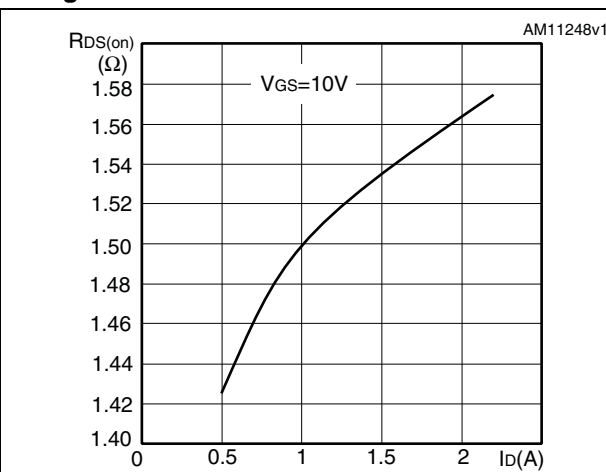

Figure 8. Capacitance variations

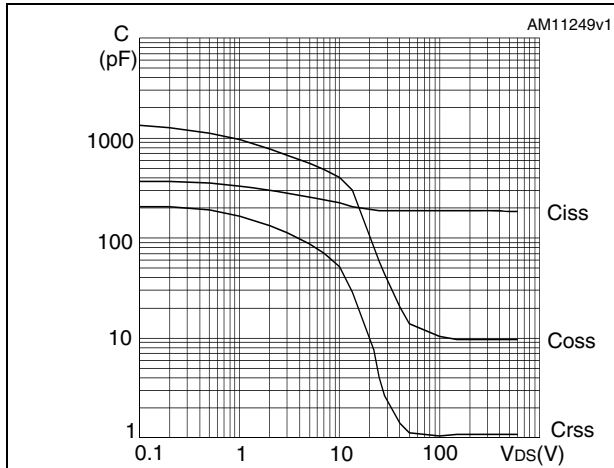

Figure 9. Output capacitance stored energy

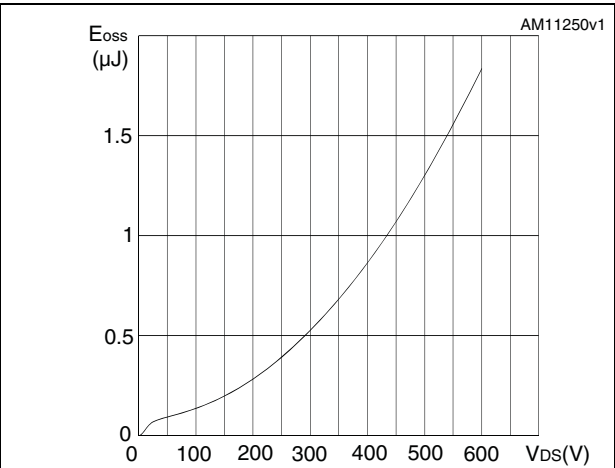

Figure 10. Normalized gate threshold voltage vs temperature

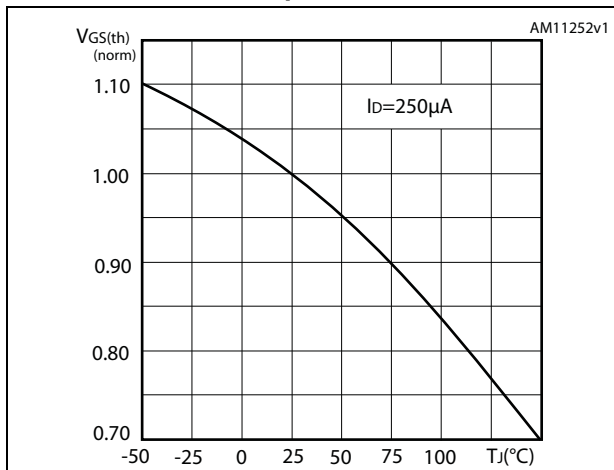

Figure 11. Normalized on resistance vs temperature

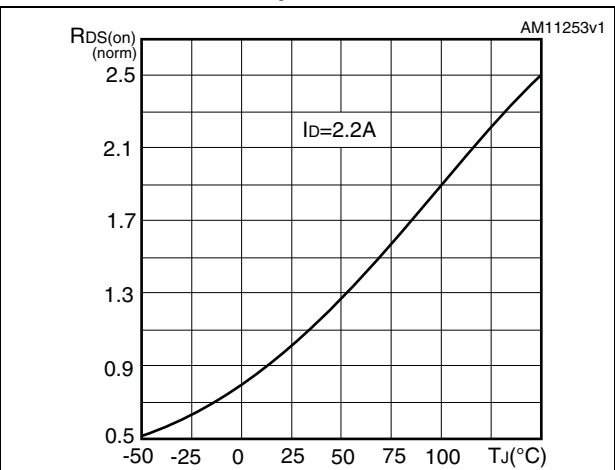

Figure 12. Normalized V(BR)DSS vs temperature

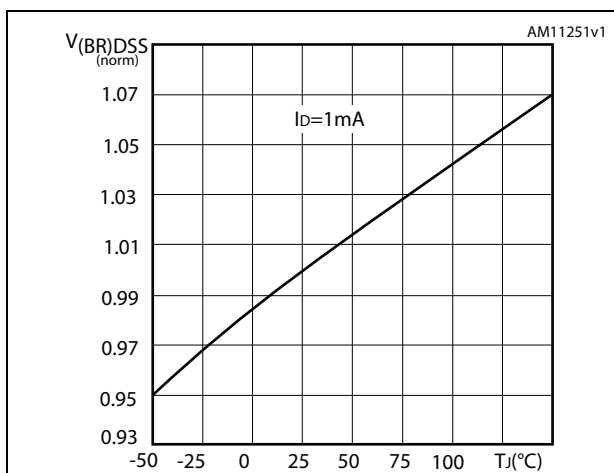
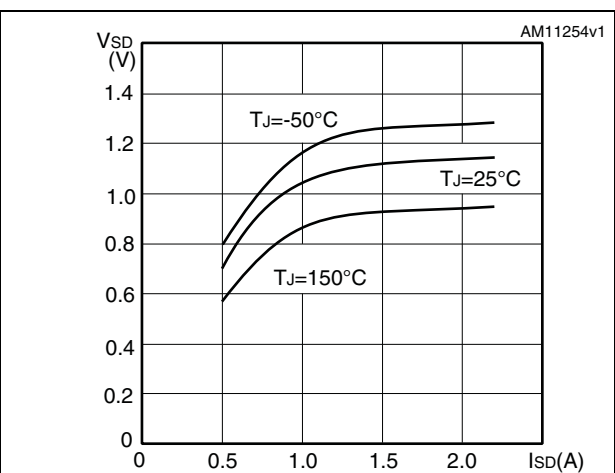

Figure 13. Source-drain diode forward characteristics



3 Test circuits

Figure 14. Switching times test circuit for resistive load



Figure 15. Gate charge test circuit

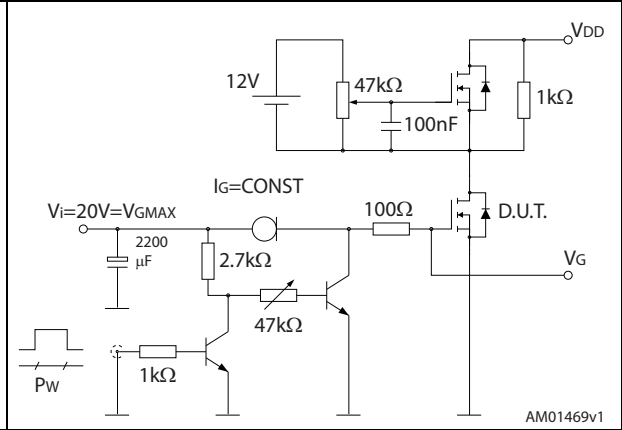

Figure 16. Test circuit for inductive load switching and diode recovery times



Figure 17. Unclamped inductive load test circuit



Figure 18. Unclamped inductive waveform

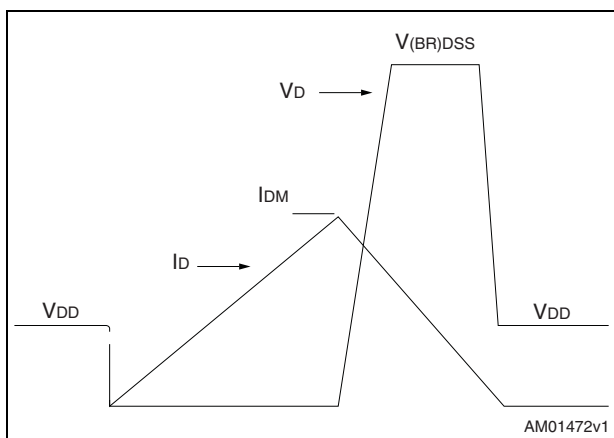
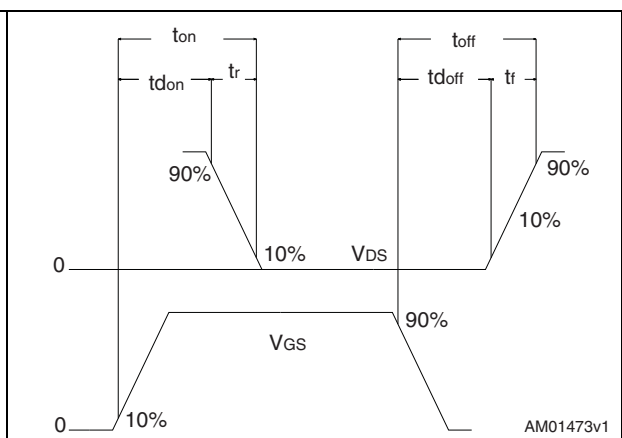

Figure 19. Switching time waveform



4 Package mechanical data

In order to meet environmental requirements, ST offers these devices in different grades of ECOPACK[®] packages, depending on their level of environmental compliance. ECOPACK[®] specifications, grade definitions and product status are available at: www.st.com. ECOPACK[®] is an ST trademark.

Figure 20. PowerFLAT™ 3.3 x 3.3 HV drawing

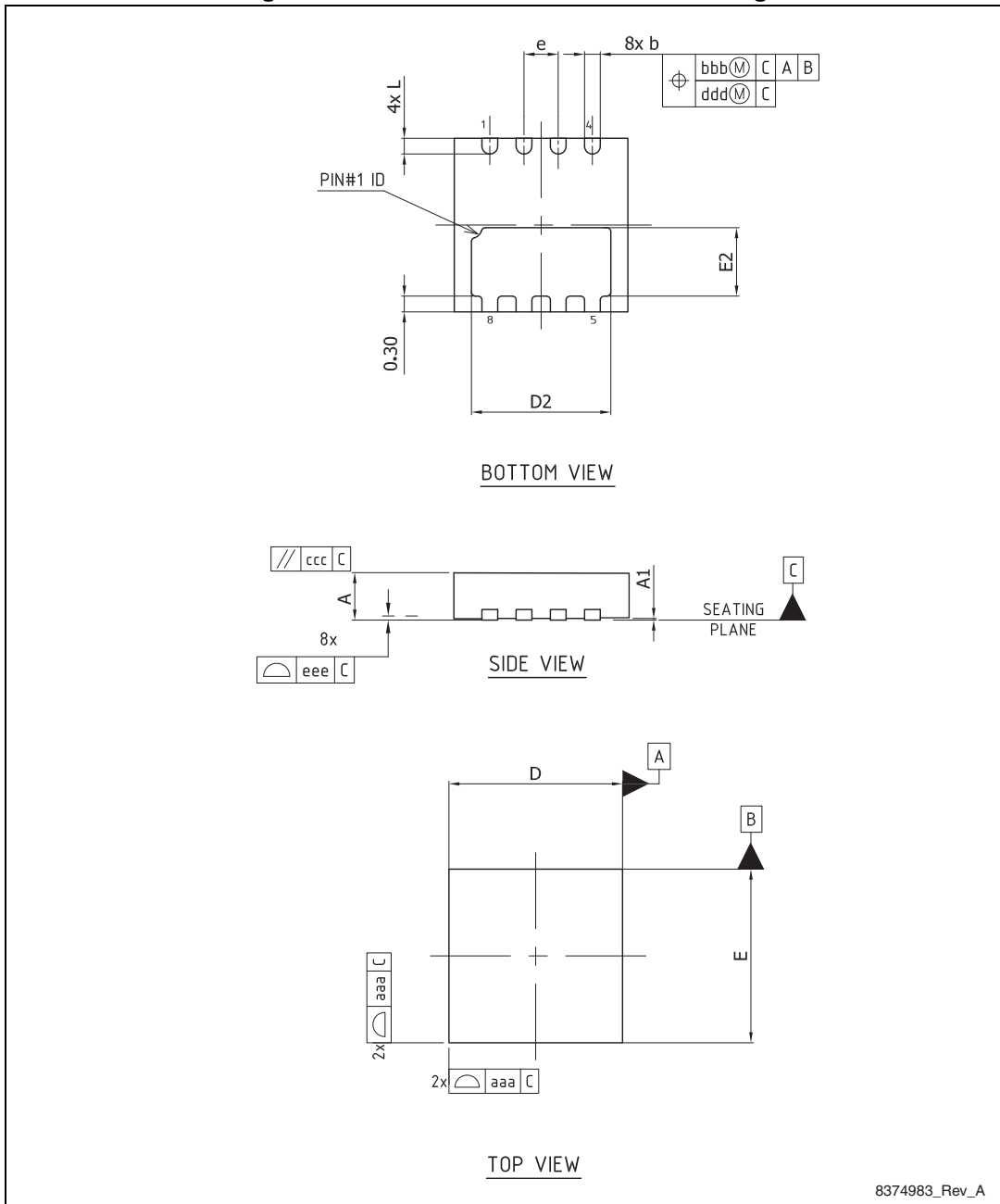
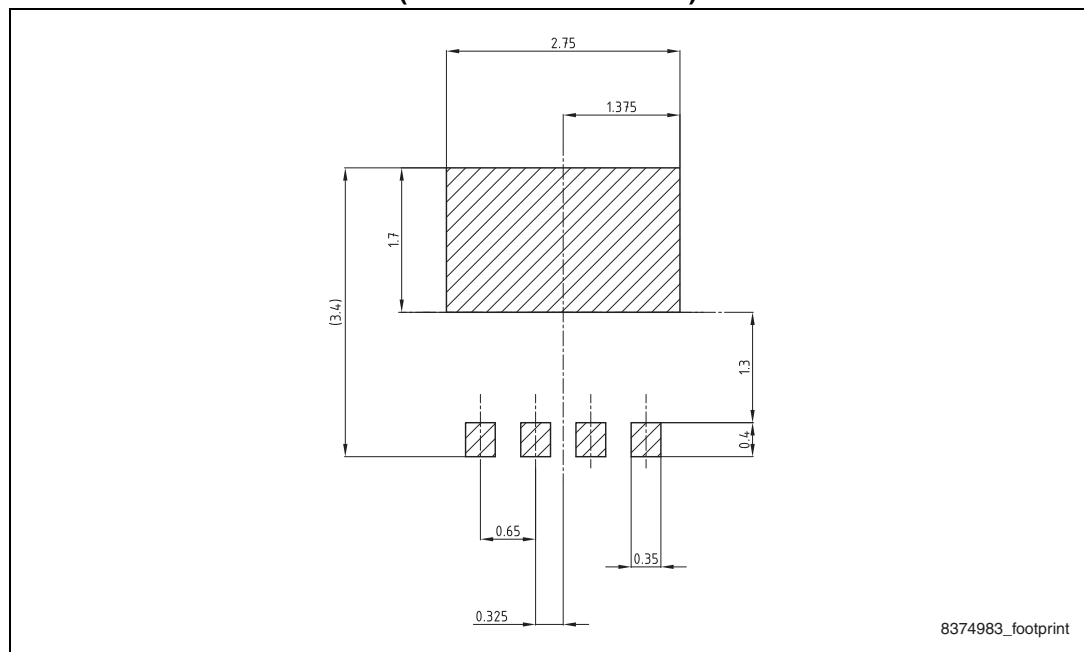

Table 8. PowerFLAT™ 3.3 x 3.3 HV mechanical data

Dim.	mm		
	Min.	Typ.	Max.
A	0.80	0.90	1.00
A1	0	0.02	0.05
b	0.25	0.30	0.40
D		3.30	
D2	2.50	2.65	2.75
E		3.30	
E2	1.15	1.30	1.40
e		0.65	
L	0.20	0.30	0.40
aaa		0.10	
bbb		0.10	
ccc		0.10	
ddd		0.05	
eee		0.08	

Figure 21. PowerFLAT™ 3.3 x 3.3 HV recommended footprint
(dimensions are in mm)

5 Revision history

Table 9. Document revision history

Date	Revision	Changes
12-Mar-2012	1	First release.
19-Nov-2014	2	Document status changed from preliminary to production data. Updated <i>Figure 1.: Internal schematic diagram</i> , <i>Figure 2.: Safe operating area</i> , <i>Figure 3.: Thermal impedance</i> and <i>Figure 12.: Normalized $V_{(BR)DSS}$ vs temperature</i> . Updated <i>Table 5.: Dynamic</i> and <i>Table 7.: Source drain diode</i> . Minor text changes.

IMPORTANT NOTICE – PLEASE READ CAREFULLY

STMicroelectronics NV and its subsidiaries ("ST") reserve the right to make changes, corrections, enhancements, modifications, and improvements to ST products and/or to this document at any time without notice. Purchasers should obtain the latest relevant information on ST products before placing orders. ST products are sold pursuant to ST's terms and conditions of sale in place at the time of order acknowledgement.

Purchasers are solely responsible for the choice, selection, and use of ST products and ST assumes no liability for application assistance or the design of Purchasers' products.

No license, express or implied, to any intellectual property right is granted by ST herein.

Resale of ST products with provisions different from the information set forth herein shall void any warranty granted by ST for such product.

ST and the ST logo are trademarks of ST. All other product or service names are the property of their respective owners.

Information in this document supersedes and replaces information previously supplied in any prior versions of this document.

© 2014 STMicroelectronics – All rights reserved