

## N-channel 650 V, 0.087 $\Omega$ typ., 32 A MDmesh™ M2 Power MOSFET in a TO-220FP package

Datasheet - production data

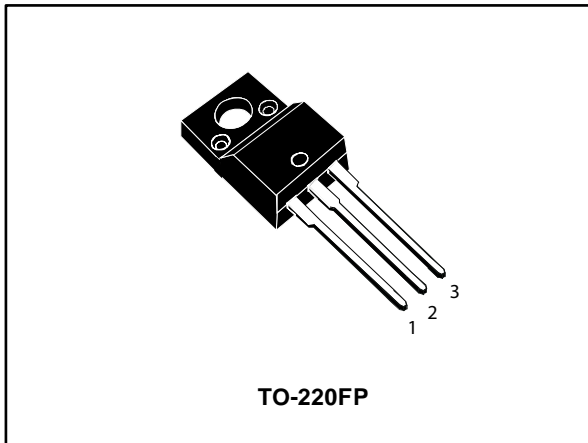
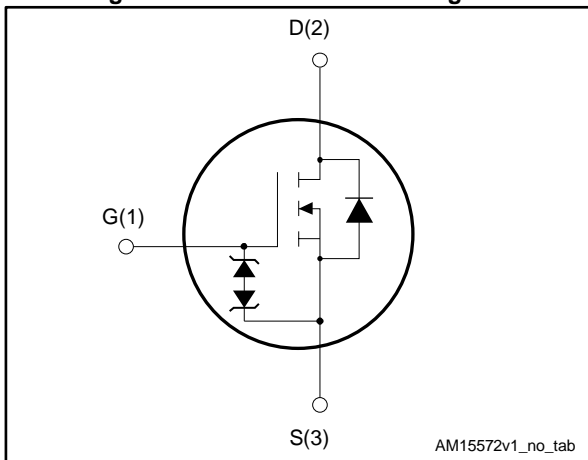

Figure 1: Internal schematic diagram



### Features

Order code	V <sub>DS</sub>	R <sub>DS(on)</sub> max.	I <sub>D</sub>
STF40N65M2	650 V	0.099 $\Omega$	32 A

- Extremely low gate charge
- Excellent output capacitance (C<sub>oss</sub>) profile
- 100% avalanche tested
- Zener-protected

### Applications

- Switching applications

### Description

This device is an N-channel Power MOSFET developed using MDmesh™ M2 technology. Thanks to its strip layout and an improved vertical structure, the device exhibits low on-resistance and optimized switching characteristics, rendering it suitable for the most demanding high efficiency converters.

Table 1: Device summary

Order code	Marking	Package	Packaging
STF40N65M2	40N65M2	TO-220FP	Tube

---

**Contents**

<b>1</b>	<b>Electrical ratings .....</b>	<b>3</b>
<b>2</b>	<b>Electrical characteristics .....</b>	<b>4</b>
	2.2 Electrical characteristics (curves).....	6
<b>3</b>	<b>Test circuits .....</b>	<b>8</b>
<b>4</b>	<b>Package information .....</b>	<b>9</b>
	4.1 TO-220FP package information .....	10
<b>5</b>	<b>Revision history .....</b>	<b>12</b>

# 1 Electrical ratings

**Table 2: Absolute maximum ratings**

Symbol	Parameter	Value	Unit
$V_{GS}$	Gate-source voltage	$\pm 25$	V
$I_D^{(1)}$	Drain current (continuous) at $T_C = 25\text{ °C}$	32	A
$I_D^{(1)}$	Drain current (continuous) at $T_C = 100\text{ °C}$	20	A
$I_{DM}^{(2)}$	Drain current (pulsed)	128	A
$P_{TOT}$	Total dissipation at $T_C = 25\text{ °C}$	25	W
$dv/dt^{(3)}$	Peak diode recovery voltage slope	15	V/ns
$dv/dt^{(4)}$	MOSFET $dv/dt$ ruggedness	50	V/ns
$V_{ISO}$	Insulation withstand voltage (RMS) from all three leads to external heat sink ( $t = 1\text{ s}$ ; $T_C = 25\text{ °C}$ )	2500	V
$T_{stg}$	Storage temperature	- 55 to 150	°C
$T_j$	Max. operating junction temperature	150	

**Notes:**

<sup>(1)</sup>Limited by maximum junction temperature.

<sup>(2)</sup>Pulse width limited by safe operating area.

<sup>(3)</sup>  $I_{SD} \leq 32\text{ A}$ ,  $di/dt \leq 400\text{ A}/\mu\text{s}$ ;  $V_{DS\ peak} < V_{(BR)DSS}$ ,  $V_{DD} = 400\text{ V}$

<sup>(4)</sup>  $V_{DS} \leq 520\text{ V}$

**Table 3: Thermal data**

Symbol	Parameter	Value	Unit
$R_{thj-case}$	Thermal resistance junction-case max	3.13	°C/W
$R_{thj-amb}$	Thermal resistance junction-ambient max	62.50	°C/W

**Table 4: Avalanche characteristics**

Symbol	Parameter	Value	Unit
$I_{AR}$	Avalanche current, repetitive or not repetitive (pulse width limited by $T_{jmax}$ )	3	A
$E_{AS}$	Single pulse avalanche energy (starting $T_j = 25\text{ °C}$ , $I_D = I_{AR}$ , $V_{DD} = 50\text{ V}$ )	820	mJ

## 2 Electrical characteristics

( $T_C = 25\text{ °C}$  unless otherwise specified)

**Table 5: On/off states**

Symbol	Parameter	Test conditions	Min.	Typ.	Max.	Unit
$V_{(BR)DSS}$	Drain-source breakdown voltage	$V_{GS} = 0\text{ V}$ , $I_D = 1\text{ mA}$	650			V
$I_{DSS}$	Zero gate voltage Drain current	$V_{GS} = 0\text{ V}$ , $V_{DS} = 650\text{ V}$			1	$\mu\text{A}$
		$V_{GS} = 0\text{ V}$ , $V_{DS} = 650\text{ V}$ , $T_C = 125\text{ °C}$			100	$\mu\text{A}$
$I_{GSS}$	Gate-body leakage current	$V_{DS} = 0\text{ V}$ , $V_{GS} = \pm 25\text{ V}$			$\pm 10$	$\mu\text{A}$
$V_{GS(th)}$	Gate threshold voltage	$V_{DS} = V_{GS}$ , $I_D = 250\text{ }\mu\text{A}$	2	3	4	V
$R_{DS(on)}$	Static drain-source on-resistance	$V_{GS} = 10\text{ V}$ , $I_D = 16\text{ A}$		0.087	0.099	$\Omega$

**Table 6: Dynamic**

Symbol	Parameter	Test conditions	Min.	Typ.	Max.	Unit
$C_{iss}$	Input capacitance	$V_{DS} = 100\text{ V}$ , $f = 1\text{ MHz}$ , $V_{GS} = 0\text{ V}$	-	2355	-	pF
$C_{oss}$	Output capacitance		-	102	-	pF
$C_{rss}$	Reverse transfer capacitance		-	2.7	-	pF
$C_{oss\text{ eq.}}^{(1)}$	Equivalent output capacitance	$V_{DS} = 0\text{ V to } 520\text{ V}$ , $V_{GS} = 0\text{ V}$	-	380	-	pF
$R_G$	Intrinsic gate resistance	$f = 1\text{ MHz open drain}$	-	4.5	-	$\Omega$
$Q_g$	Total gate charge	$V_{DD} = 520\text{ V}$ , $I_D = 32\text{ A}$ , $V_{GS} = 10\text{ V}$ (see <a href="#">Figure 15: "Gate charge test circuit"</a> )	-	56.5	-	nC
$Q_{gs}$	Gate-source charge		-	8	-	nC
$Q_{gd}$	Gate-drain charge		-	24	-	nC

**Notes:**

<sup>(1)</sup> $C_{oss\text{ eq.}}$  is defined as a constant equivalent capacitance giving the same charging time as  $C_{oss}$  when  $V_{DS}$  increases from 0 to 80%  $V_{DSS}$

Table 7: Switching times

Symbol	Parameter	Test conditions	Min.	Typ.	Max.	Unit
$t_{d(on)}$	Turn-on delay time	$V_{DD} = 325 \text{ V}$ , $I_D = 16 \text{ A}$ $R_G = 4.7 \text{ } \Omega$ , $V_{GS} = 10 \text{ V}$ (see <a href="#">Figure 14: "Switching times test circuit for resistive load"</a> and <a href="#">Figure 19: "Switching time waveform"</a> )	-	15	-	ns
$t_r$	Rise time		-	10	-	ns
$t_{d(off)}$	Turn-off-delay time		-	96.5	-	ns
$t_f$	Fall time		-	12	-	ns

Table 8: Source drain diode

Symbol	Parameter	Test conditions	Min.	Typ.	Max.	Unit
$I_{SD}$	Source-drain current		-		32	A
$I_{SDM}^{(1)}$	Source-drain current (pulsed)		-		128	A
$V_{SD}^{(2)}$	Forward on voltage	$V_{GS} = 0 \text{ V}$ , $I_{SD} = 32 \text{ A}$	-		1.6	V
$t_{rr}$	Reverse recovery time	$I_{SD} = 32 \text{ A}$ , $di/dt = 100 \text{ A}/\mu\text{s}$ , $V_{DD} = 60 \text{ V}$ (see <a href="#">Figure 16: "Test circuit for inductive load switching and diode recovery times"</a> )	-	468		ns
$Q_{rr}$	Reverse recovery charge		-	8.7		$\mu\text{C}$
$I_{RRM}$	Reverse recovery current		-	37.5		A
$t_{rr}$	Reverse recovery time	$I_{SD} = 32 \text{ A}$ , $di/dt = 100 \text{ A}/\mu\text{s}$ , $V_{DD} = 60 \text{ V}$ , $T_j = 150 \text{ }^\circ\text{C}$ (see <a href="#">Figure 16: "Test circuit for inductive load switching and diode recovery times"</a> )	-	610		ns
$Q_{rr}$	Reverse recovery charge		-	11.7		$\mu\text{C}$
$I_{RRM}$	Reverse recovery current		-	39		A

**Notes:**

<sup>(1)</sup>Pulse width is limited by safe operating area

<sup>(2)</sup>Pulse test: pulse duration = 300  $\mu\text{s}$ , duty cycle 1.5%

2.2 Electrical characteristics (curves)

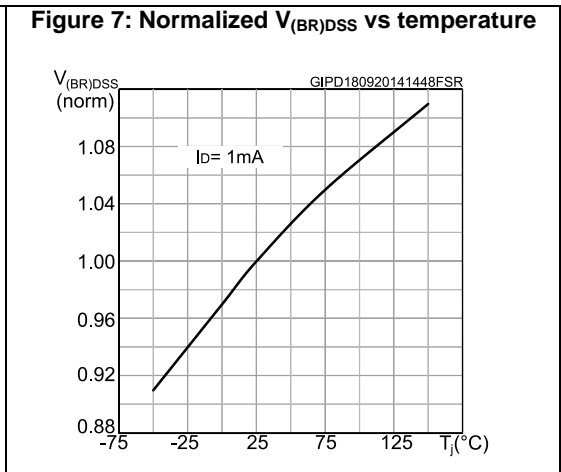
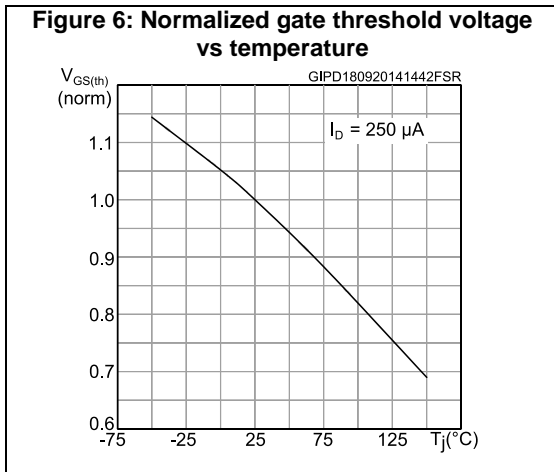
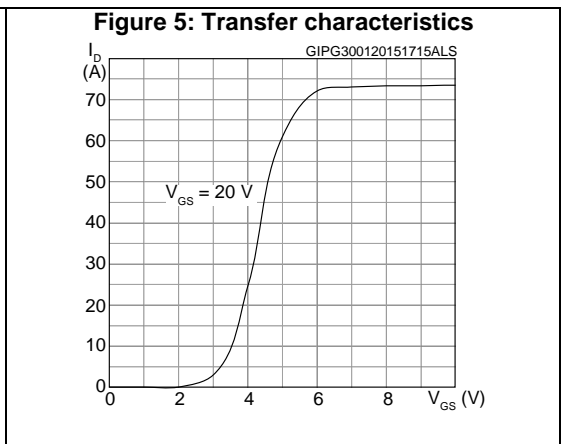
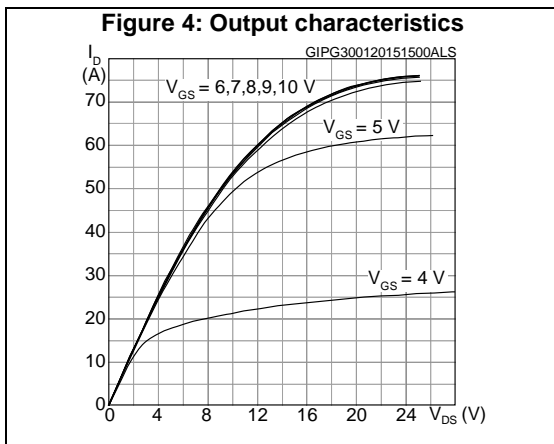
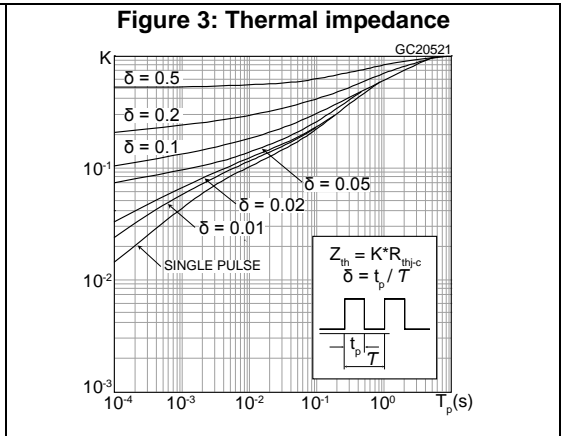
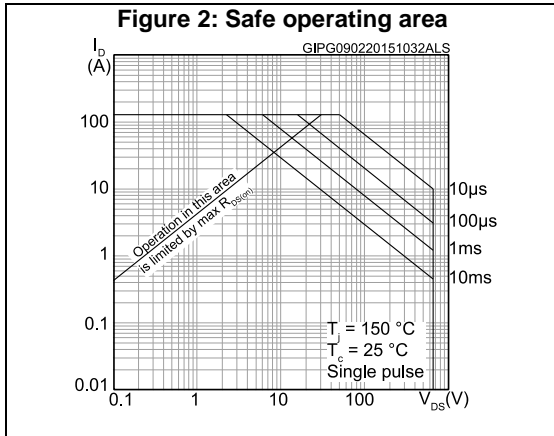

Figure 8: Static drain-source on-resistance

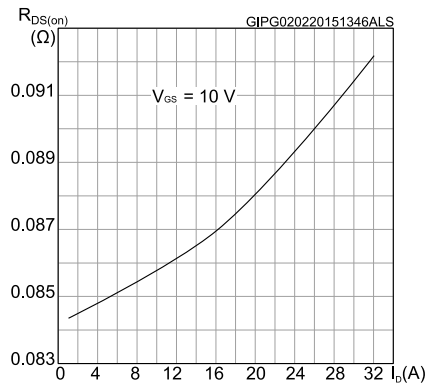

Figure 9: Normalized on-resistance vs. temperature

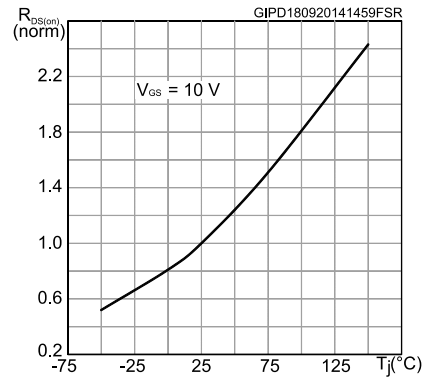

Figure 10: Gate charge vs. gate-source voltage

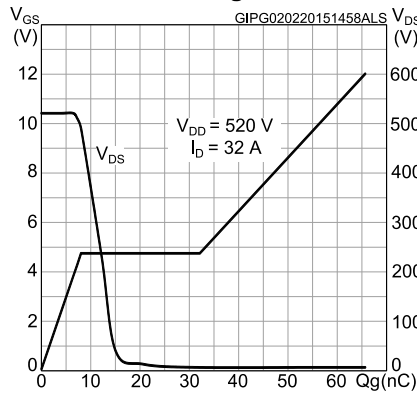

Figure 11: Capacitance variations

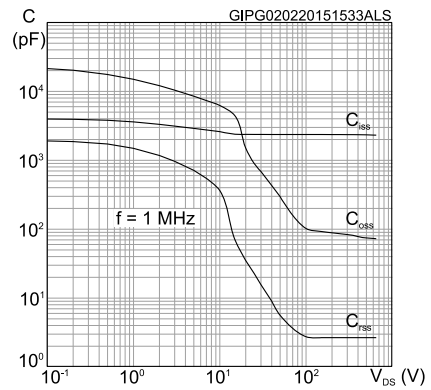

Figure 12: Output capacitance stored energy

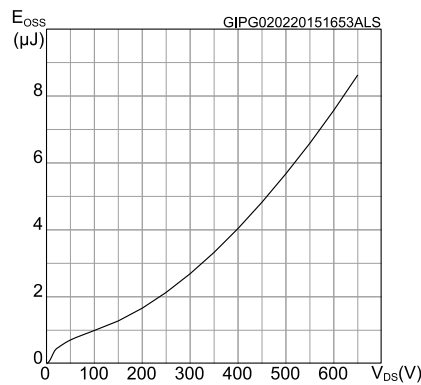
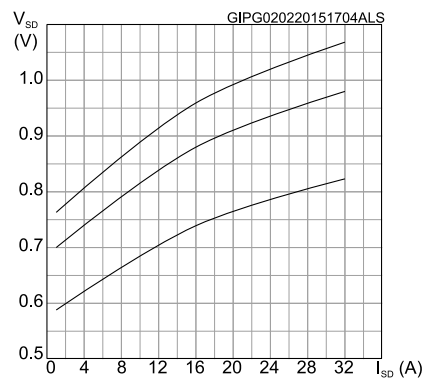
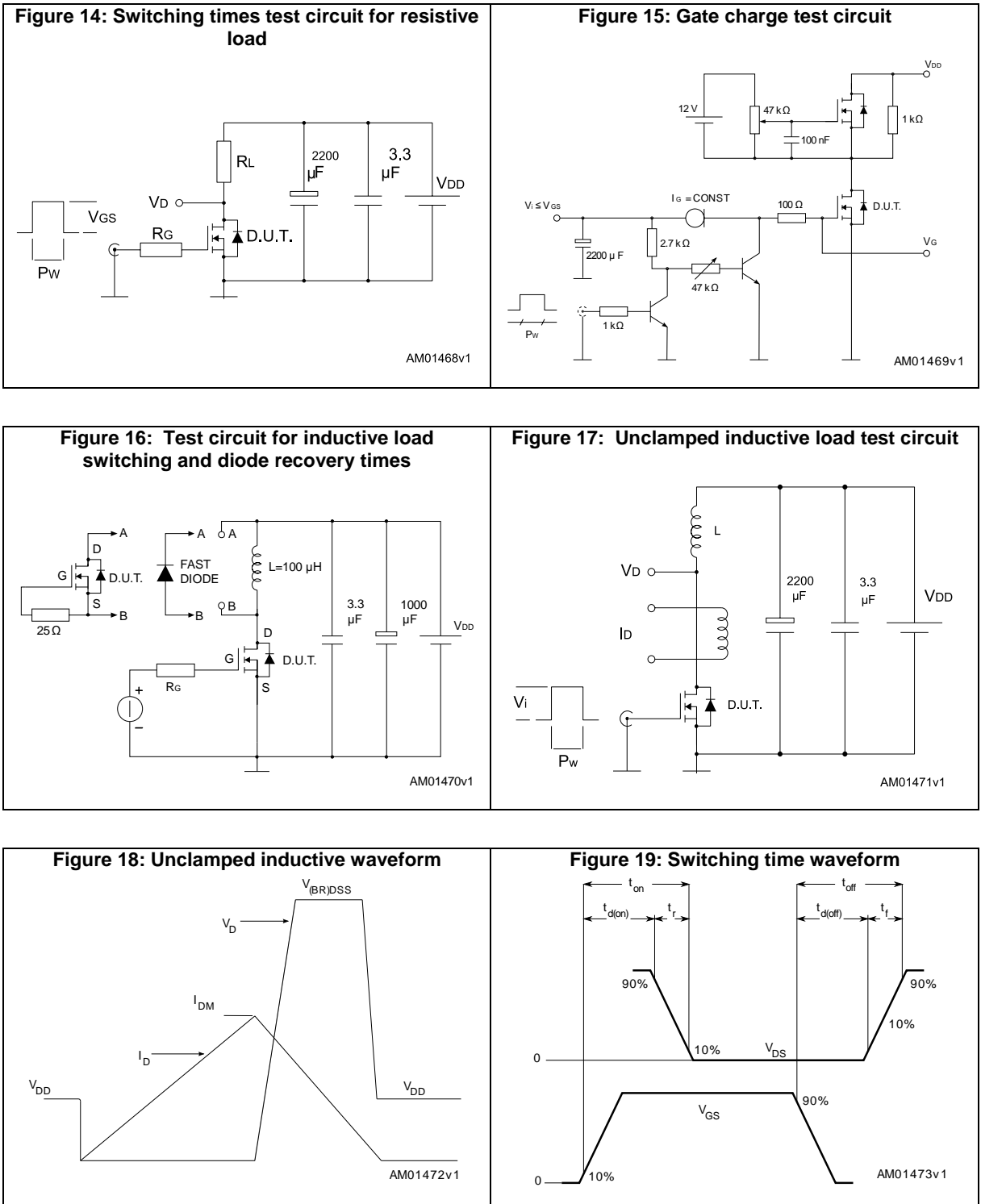

Figure 13: Source-drain diode forward characteristics



### 3 Test circuits





## 4 Package information

In order to meet environmental requirements, ST offers these devices in different grades of ECOPACK<sup>®</sup> packages, depending on their level of environmental compliance. ECOPACK<sup>®</sup> specifications, grade definitions and product status are available at: [www.st.com](http://www.st.com). ECOPACK<sup>®</sup> is an ST trademark.

### 4.1 TO-220FP package information

Figure 20: TO-220FP package outline

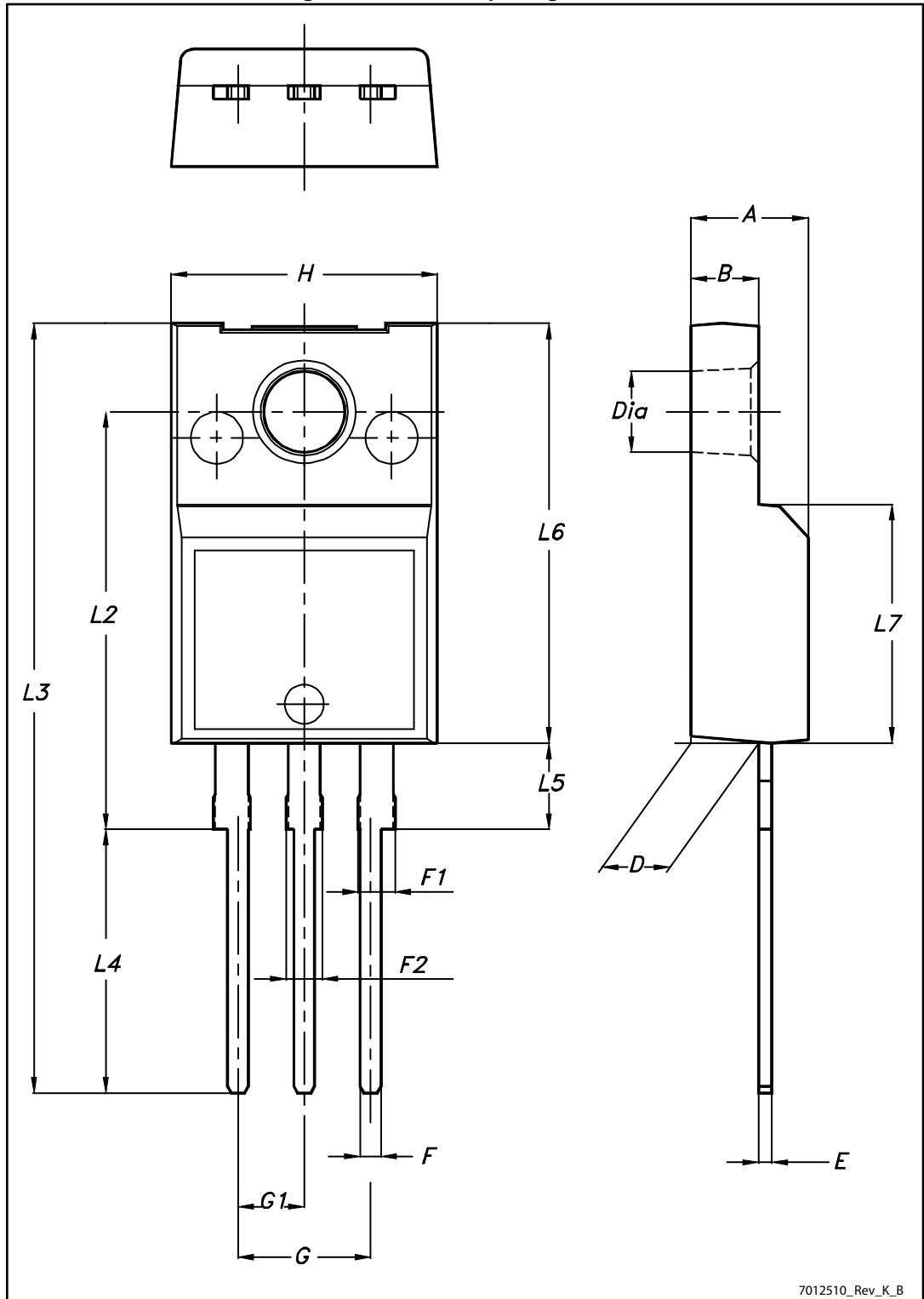

7012510\_Rev\_K\_B

Table 9: TO-220FP mechanical data

Dim.	mm		
	Min.	Typ.	Max.
A	4.4		4.6
B	2.5		2.7
D	2.5		2.75
E	0.45		0.7
F	0.75		1
F1	1.15		1.70
F2	1.15		1.70
G	4.95		5.2
G1	2.4		2.7
H	10		10.4
L2		16	
L3	28.6		30.6
L4	9.8		10.6
L5	2.9		3.6
L6	15.9		16.4
L7	9		9.3
Dia	3		3.2

## 5 Revision history

Table 10: Document revision history

Date	Revision	Changes
09-Feb-2014	1	First release.

**IMPORTANT NOTICE – PLEASE READ CAREFULLY**

STMicroelectronics NV and its subsidiaries ("ST") reserve the right to make changes, corrections, enhancements, modifications, and improvements to ST products and/or to this document at any time without notice. Purchasers should obtain the latest relevant information on ST products before placing orders. ST products are sold pursuant to ST's terms and conditions of sale in place at the time of order acknowledgement.

Purchasers are solely responsible for the choice, selection, and use of ST products and ST assumes no liability for application assistance or the design of Purchasers' products.

No license, express or implied, to any intellectual property right is granted by ST herein.

Resale of ST products with provisions different from the information set forth herein shall void any warranty granted by ST for such product.

ST and the ST logo are trademarks of ST. All other product or service names are the property of their respective owners.

Information in this document supersedes and replaces information previously supplied in any prior versions of this document.

© 2015 STMicroelectronics – All rights reserved