

Automotive-grade N-channel 100 V, 6.8 mΩ typ., 80 A, STripFET™ F7 Power MOSFET in a DPAK package

Datasheet - production data

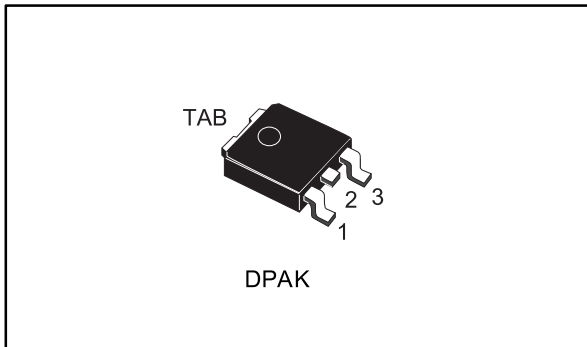
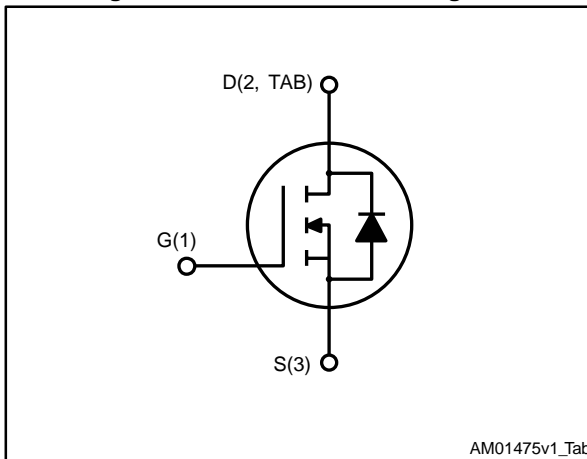

Figure 1: Internal schematic diagram



AM01475v1_Tab

Features

Order code	V _{DS}	R _{DS(on)} max.	I _D	P _{TOT}
STD105N10F7AG	100 V	8 mΩ	80 A	120 W

- Designed for automotive applications and AEC-Q101 qualified
- Among the lowest R_{DS(on)} on the market
- Excellent FoM (figure of merit)
- Low C_{rss}/C_{iss} ratio for EMI immunity
- High avalanche ruggedness

Applications

- Switching applications

Description

This N-channel Power MOSFET utilizes STripFET™ F7 technology with an enhanced trench gate structure that results in very low on-state resistance, while also reducing internal capacitance and gate charge for faster and more efficient switching.

Table 1: Device summary

Order code	Marking	Package	Packing
STD105N10F7AG	105N10F7	DPAK	Tape and reel

Contents

1	Electrical ratings	3
2	Electrical characteristics	4
	2.1 Electrical characteristics (curves).....	6
3	Test circuits	8
4	Package information	9
	4.1 DPAK (TO-252) type A2 package information.....	10
5	Revision history	13

1 Electrical ratings

Table 2: Absolute maximum ratings

Symbol	Parameter	Value	Unit
V_{DS}	Drain-source voltage	100	V
V_{GS}	Gate-source voltage	± 20	V
I_D	Drain current (continuous) at $T_C = 25\text{ }^\circ\text{C}$	80	A
I_D	Drain current (continuous) at $T_C = 100\text{ }^\circ\text{C}$	62	A
$I_{DM}^{(1)}$	Drain current (pulsed)	320	A
P_{TOT}	Total dissipation at $T_C = 25\text{ }^\circ\text{C}$	120	W
T_{stg}	Storage temperature range	-55 to 175	$^\circ\text{C}$
T_J	Operation junction temperature range		

Notes:

⁽¹⁾Pulse width limited by safe operating area.

Table 3: Thermal data

Symbol	Parameter	Value	Unit
$R_{thj-case}$	Thermal resistance junction-case	1.25	$^\circ\text{C}/\text{W}$
$R_{thj-pcb}^{(1)}$	Thermal resistance junction-pcb	50	

Notes:

⁽¹⁾When mounted on FR-4 board of 1 inch², 2oz Cu.

Table 4: Avalanche characteristics

Symbol	Parameter	Value	Unit
E_{AS}	Single pulse avalanche energy $T_J = 25\text{ }^\circ\text{C}$, $L = 3.5\text{ mH}$, $I_{AS} = 15\text{ A}$, $V_{DD} = 50\text{ V}$, $V_{GS} = 10\text{ V}$	400	mJ

2 Electrical characteristics

($T_{CASE} = 25\text{ °C}$ unless otherwise specified)

Table 5: On/Off states

Symbol	Parameter	Test conditions	Min.	Typ.	Max.	Unit
$V_{(BR)DSS}$	Drain-source breakdown voltage ($V_{GS} = 0$)	$I_D = 250\ \mu\text{A}$	100			V
I_{DSS}	Zero gate voltage drain current ($V_{GS} = 0$)	$V_{DS} = 100\ \text{V}$			1	μA
		$V_{DS} = 100\ \text{V}$, $T_C = 125\text{ °C}$ ⁽¹⁾			100	μA
I_{GSS}	Gate body leakage current ($V_{DS} = 0$)	$V_{GS} = \pm 20\ \text{V}$			± 100	nA
$V_{GS(th)}$	Gate threshold voltage	$V_{DS} = V_{GS}$, $I_D = 250\ \mu\text{A}$	2.5		4.5	V
$R_{DS(on)}$	Static drain-source on-resistance	$V_{GS} = 10\ \text{V}$, $I_D = 40\ \text{A}$		6.8	8	m Ω

Notes:

⁽¹⁾Defined by design, not subject to production test.

Table 6: Dynamic

Symbol	Parameter	Test conditions	Min.	Typ.	Max.	Unit
C_{iss}	Input capacitance	$V_{DS} = 50\ \text{V}$, $f = 1\ \text{MHz}$, $V_{GS} = 0\ \text{V}$	-	4369	-	pF
C_{oss}	Output capacitance		-	823	-	pF
C_{rss}	Reverse transfer capacitance		-	36	-	pF
Q_g	Total gate charge	$V_{DD} = 50\ \text{V}$, $I_D = 80\ \text{A}$, $V_{GS} = 10\ \text{V}$ (see Figure 14: "Test circuit for gate charge behavior")	-	61	-	nC
Q_{gs}	Gate-source charge		-	26	-	nC
Q_{gd}	Gate-drain charge		-	13	-	nC

Table 7: Switching times

Symbol	Parameter	Test conditions	Min.	Typ.	Max.	Unit
$t_{d(on)}$	Turn-on delay time	$V_{DD} = 50\ \text{V}$, $I_D = 40\ \text{A}$, $R_G = 4.7\ \Omega$, $V_{GS} = 10\ \text{V}$ (see Figure 13: "Test circuit for resistive load switching times" and Figure 18: "Switching time waveform")	-	27	-	ns
t_r	Rise time		-	40	-	ns
$t_{d(off)}$	Turn-off delay time		-	46	-	ns
t_f	Fall time		-	15	-	ns

Table 8: Source-drain diode

Symbol	Parameter	Test conditions	Min.	Typ.	Max.	Unit
I_{SD}	Source-drain current		-		80	A
$I_{SDM}^{(1)}$	Source-drain current (pulsed)		-		320	A
$V_{SD}^{(2)}$	Forward on voltage	$I_{SD} = 80 \text{ A}$, $V_{GS} = 0 \text{ V}$	-		1.2	V
t_{rr}	Reverse recovery time	$I_{SD} = 80 \text{ A}$, $di/dt = 100 \text{ A}/\mu\text{s}$ $V_{DD} = 80 \text{ V}$, $T_j = 150 \text{ }^\circ\text{C}$	-	77		ns
Q_{rr}	Reverse recovery charge		-	146		nC
I_{RRM}	Reverse recovery current		-	4		A

Notes:

⁽¹⁾Pulse width limited by safe operating area.

⁽²⁾Pulsed: pulse duration = 300 μs , duty cycle 1.5 %.

2.1 Electrical characteristics (curves)

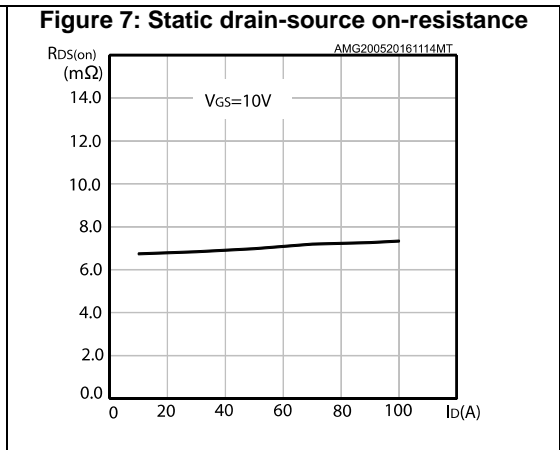
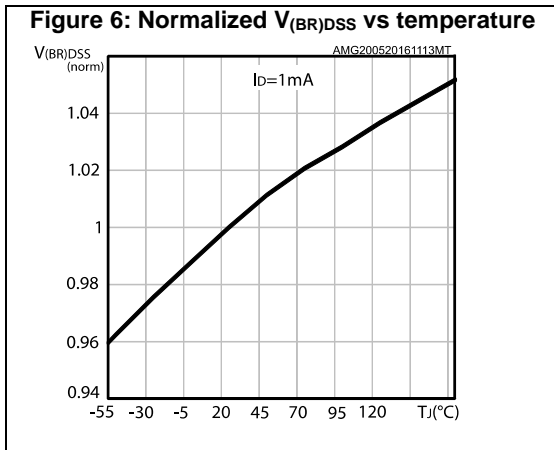
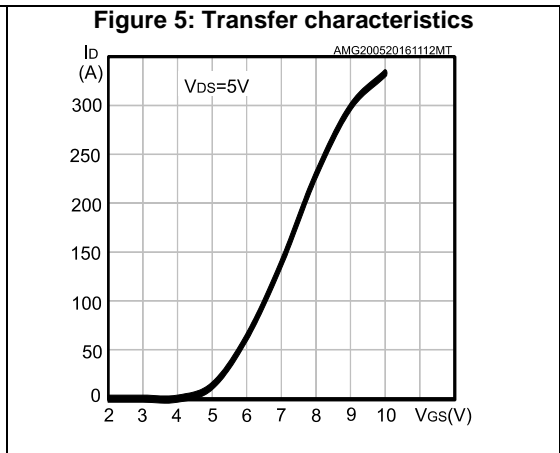
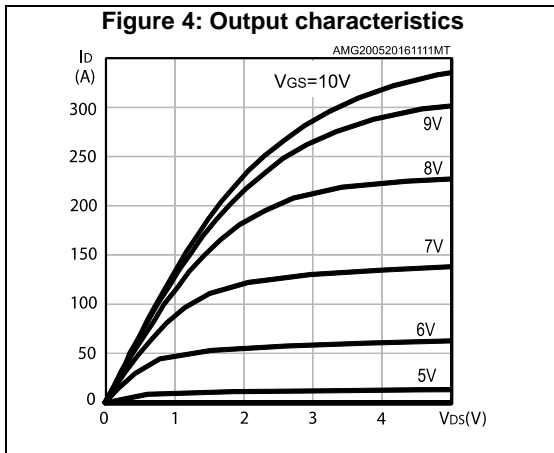
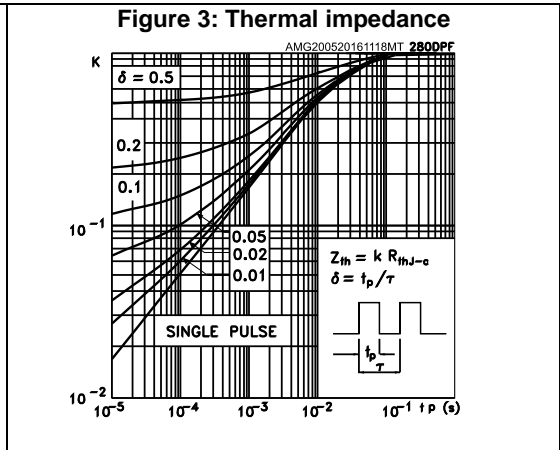
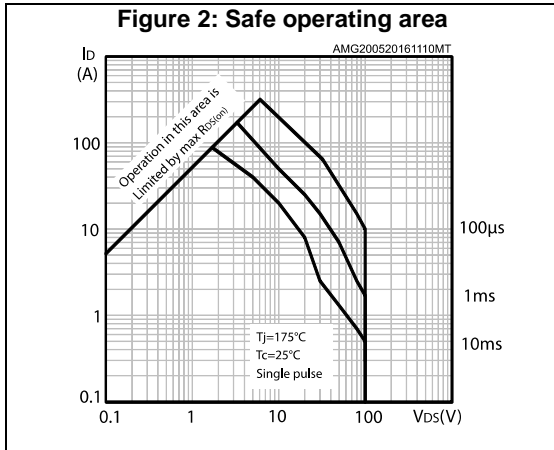

Figure 8: Gate charge vs gate-source voltage

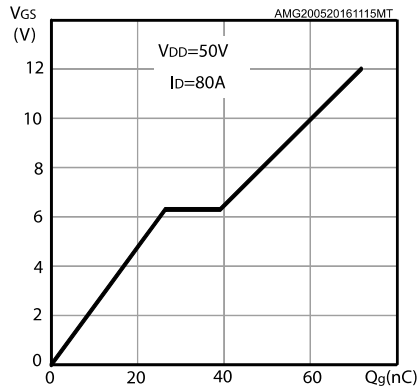

Figure 9: Capacitance variations

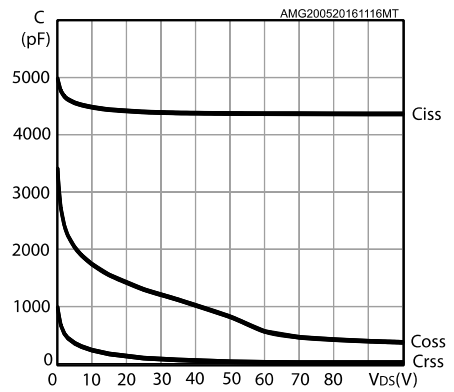

Figure 10: Normalized gate threshold voltage vs temperature

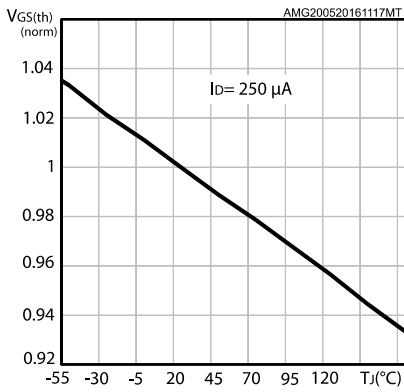

Figure 11: Normalized on-resistance vs temperature

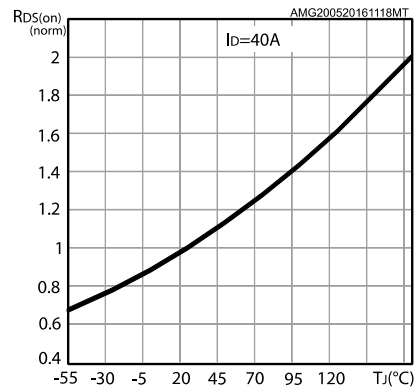
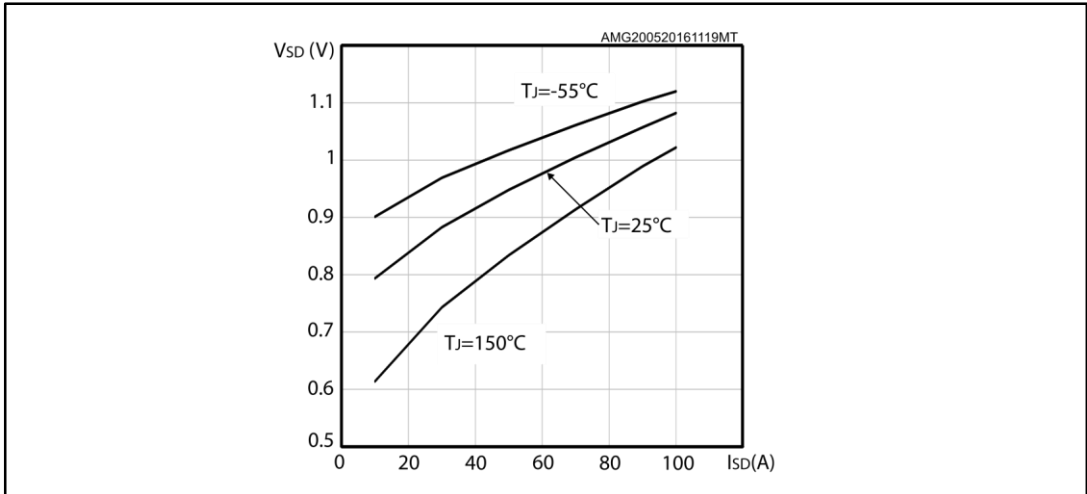

Figure 12: Source-drain diode forward characteristics



3 Test circuits

Figure 13: Test circuit for resistive load switching times



AM01468v1

Figure 14: Test circuit for gate charge behavior



AM01469v1

Figure 15: Test circuit for inductive load switching and diode recovery times



AM01470v1

Figure 16: Unclamped inductive load test circuit

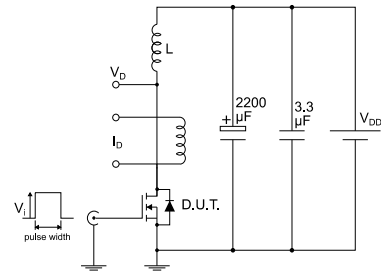

AM01471v1

Figure 17: Unclamped inductive waveform

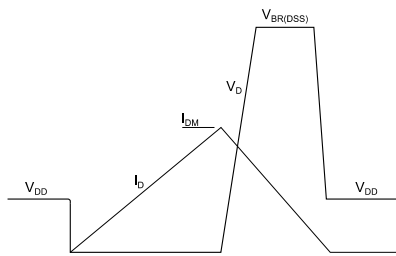

AM01472v1

Figure 18: Switching time waveform

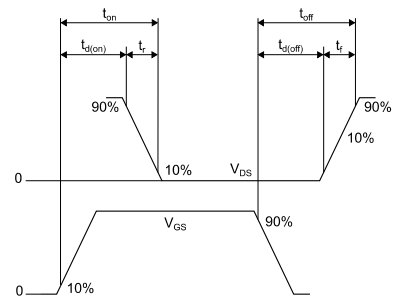

AM01473v1

4 Package information

In order to meet environmental requirements, ST offers these devices in different grades of ECOPACK® packages, depending on their level of environmental compliance. ECOPACK® specifications, grade definitions and product status are available at: www.st.com. ECOPACK® is an ST trademark.

4.1 DPAK (TO-252) type A2 package information

Figure 19: DPAK (TO-252) type A2 package outline

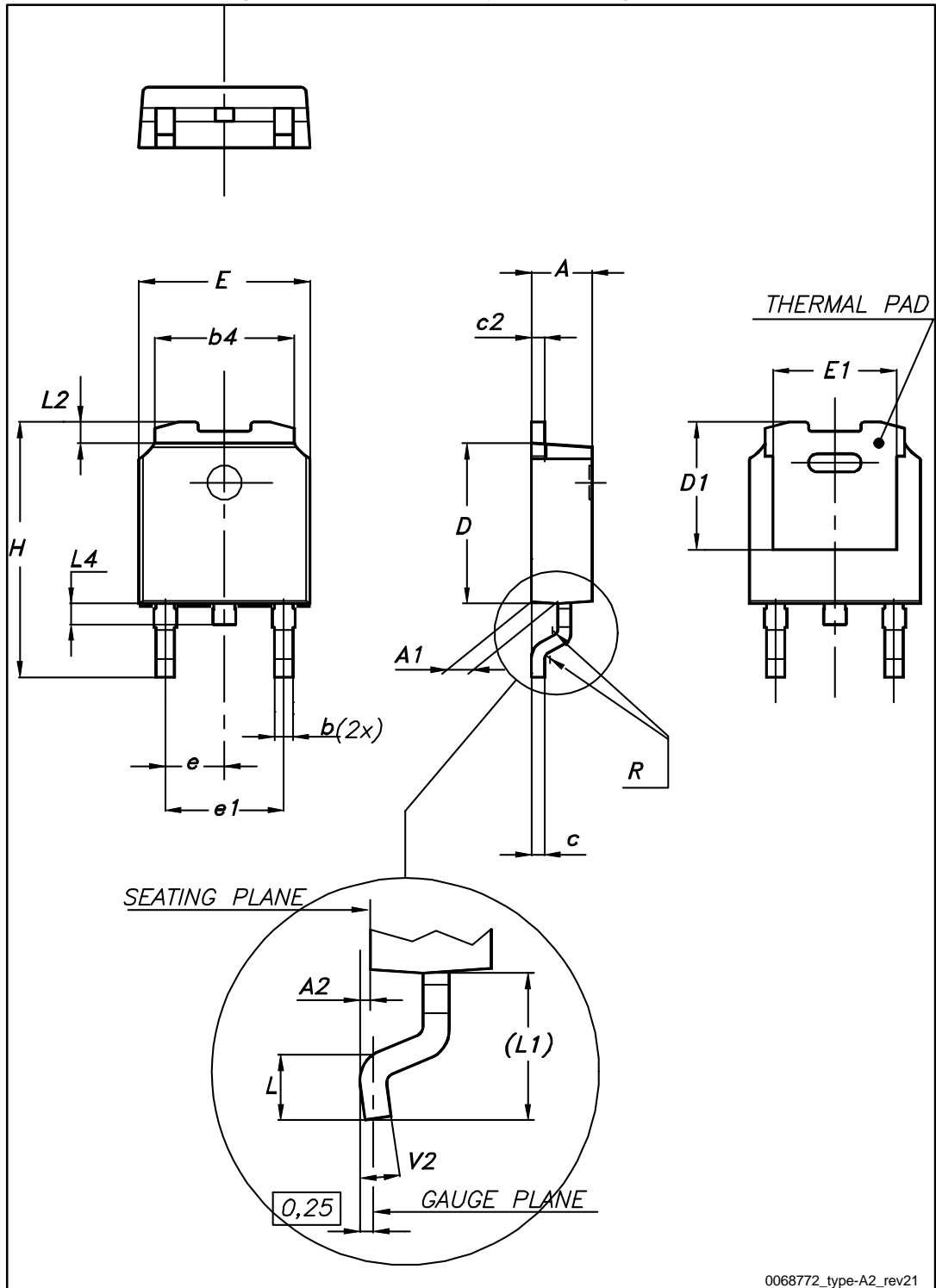
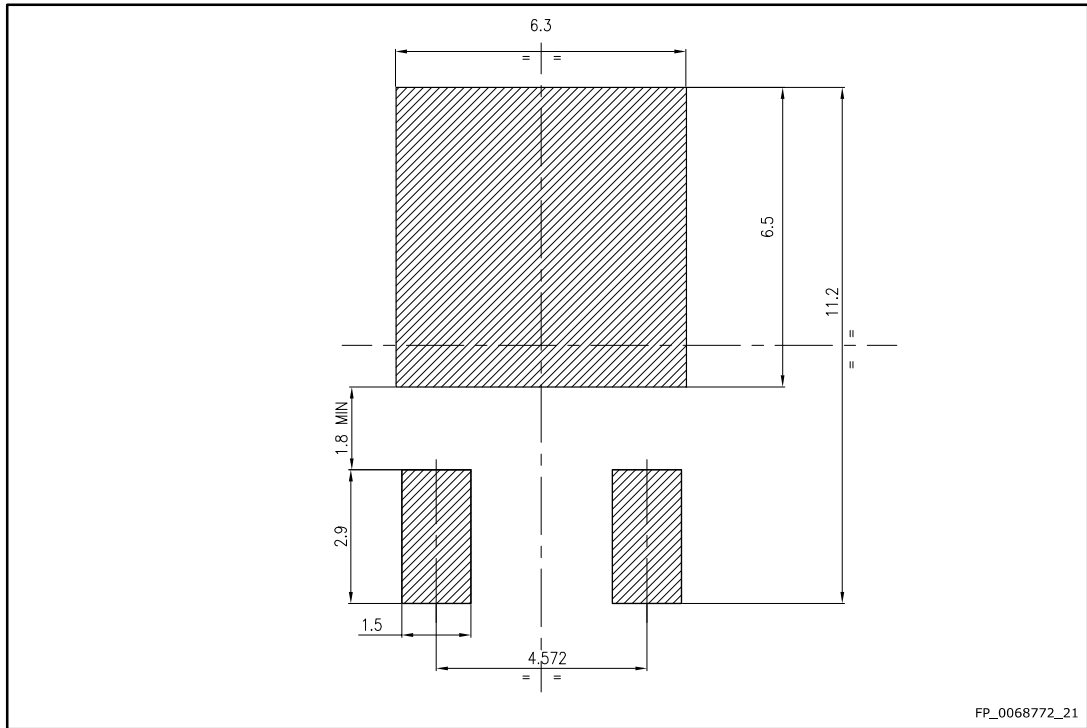

Table 9: DPAK (TO-252) type A2 mechanical data

Dim.	mm		
	Min.	Typ.	Max.
A	2.20		2.40
A1	0.90		1.10
A2	0.03		0.23
b	0.64		0.90
b4	5.20		5.40
c	0.45		0.60
c2	0.48		0.60
D	6.00		6.20
D1	4.95	5.10	5.25
E	6.40		6.60
E1	5.10	5.20	5.30
e	2.16	2.28	2.40
e1	4.40		4.60
H	9.35		10.10
L	1.00		1.50
L1	2.60	2.80	3.00
L2	0.65	0.80	0.95
L4	0.60		1.00
R		0.20	
V2	0°		8°

Figure 20: DPAK (TO-252) recommended footprint (dimensions are in mm)



5 Revision history

Table 10: Document revision history

Date	Revision	Changes
23-Oct-2014	1	First release.
30-Oct-2014	2	Document status promoted from preliminary to production data.
20-May-2016	3	Updated Section 4.1: "DPAK (TO-252) type A2 package information". Minor text changes.
03-Jun-2016	4	Updated title and features in cover page. Updated Table 5: "On/Off states" . Minor text changes.

IMPORTANT NOTICE – PLEASE READ CAREFULLY

STMicroelectronics NV and its subsidiaries ("ST") reserve the right to make changes, corrections, enhancements, modifications, and improvements to ST products and/or to this document at any time without notice. Purchasers should obtain the latest relevant information on ST products before placing orders. ST products are sold pursuant to ST's terms and conditions of sale in place at the time of order acknowledgement.

Purchasers are solely responsible for the choice, selection, and use of ST products and ST assumes no liability for application assistance or the design of Purchasers' products.

No license, express or implied, to any intellectual property right is granted by ST herein.

Resale of ST products with provisions different from the information set forth herein shall void any warranty granted by ST for such product.

ST and the ST logo are trademarks of ST. All other product or service names are the property of their respective owners.

Information in this document supersedes and replaces information previously supplied in any prior versions of this document.

© 2016 STMicroelectronics – All rights reserved