

## High voltage fast-switching NPN power transistor

### General features

- Improved specification: Lower leakage current, Tighter gain range, DC current gain preselection, Tighter storage time range
- High voltage capability
- Integrated free-wheeling diode
- Low spread of dynamic parameters
- Minimum lot-to-lot spread for reliable operation
- Very high switching speed
- Fully characterized at 125 °C
- Large RBSOA
- In compliance with the 2002/93/EC European Directive

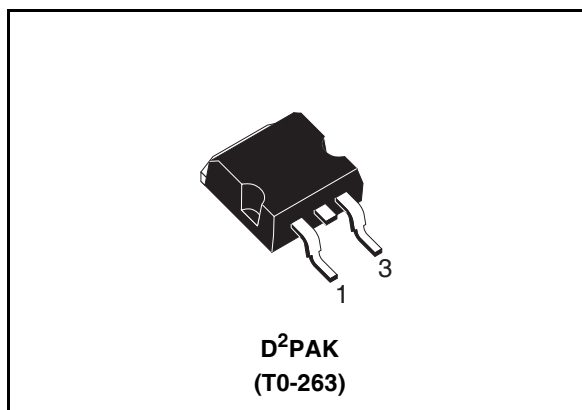

### Description

The device is manufactured using high voltage Multi-Epitaxial Planar technology for high switching speeds and medium voltage capability.

It uses a Cellular Emitter structure to enhance switching speeds.

### Applications

- Electronic transformers for halogen lamps
- Switch mode power supplies

### Internal schematic diagram

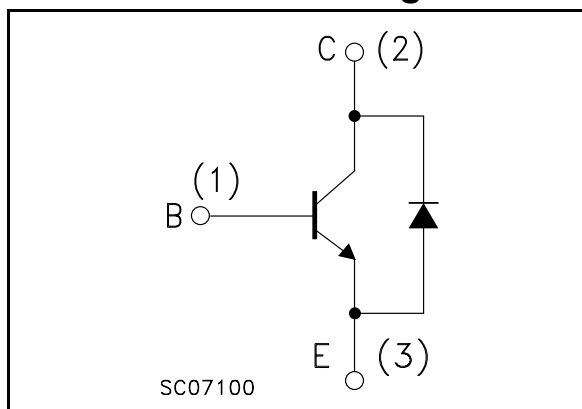

### Order codes

Part Number	Marking	Package	Packing
STB13007DT4	B13007D	D <sup>2</sup> PAK	Tape & Reel

---

## Contents

<b>1</b>	<b>Electrical ratings</b> .....	<b>3</b>
<b>2</b>	<b>Electrical characteristics</b> .....	<b>4</b>
2.1	Electrical characteristics (curves) .....	5
2.2	Test circuits .....	6
<b>3</b>	<b>Package mechanical data</b> .....	<b>7</b>
<b>4</b>	<b>Revision history</b> .....	<b>9</b>

# 1 Electrical ratings

**Table 1. Absolute maximum rating**

Symbol	Parameter	Value	Unit
$V_{CEV}$	Collector-emitter voltage ( $V_{BE} = -1.5V$ )	700	V
$V_{CEO}$	Collector-emitter voltage ( $I_B = 0$ )	400	V
$V_{EBO}$	Emitter-base voltage ( $I_C = 0$ )	9	V
$I_C$	Collector current	8	A
$I_{CM}$	Collector peak current ( $t_P < 5ms$ )	16	A
$I_B$	Base current	4	A
$I_{BM}$	Base peak current ( $t_P < 5ms$ )	8	A
$P_{tot}$	Total dissipation at $T_C = 25^\circ C$	80	W
$T_{stg}$	Storage temperature	-65 to 150	$^\circ C$
$T_J$	Max. operating junction temperature	150	$^\circ C$

**Table 2. Thermal data**

Symbol	Parameter	Value	Unit
$R_{thj-case}$	Thermal resistance junction-case max	1.56	$^\circ C/W$
$R_{thj-amb}$	Thermal resistance junction-amb max	62.5	$^\circ C/W$

## 2 Electrical characteristics

( $T_{\text{case}} = 25^{\circ}\text{C}$  unless otherwise specified)

**Table 3. Electrical characteristics**

Symbol	Parameter	Test Conditions	Min.	Typ.	Max.	Unit
$I_{\text{CES}}$	Collector cut-off current ( $V_{\text{BE}} = 0\text{V}$ )	$V_{\text{CE}} = 700\text{V}$ $V_{\text{CE}} = 700\text{V}$ $T_{\text{C}} = 100^{\circ}\text{C}$			10 0.5	$\mu\text{A}$ mA
$I_{\text{CEO}}$	Collector cut-off current ( $I_{\text{B}} = 0$ )	$V_{\text{CE}} = 400\text{V}$			100	$\mu\text{A}$
$I_{\text{EBO}}$	Emitter cut-off current ( $I_{\text{C}} = 0$ )	$V_{\text{EB}} = 9\text{V}$			100	$\mu\text{A}$
$V_{\text{CEO(sus)}}^{(1)}$	Collector-emitter sustaining voltage ( $I_{\text{B}} = 0$ )	$I_{\text{C}} = 10\text{mA}$	400			V
$V_{\text{CE(sat)}}^{(1)}$	Collector-emitter saturation voltage	$I_{\text{C}} = 2\text{A}$ $I_{\text{B}} = 0.4\text{A}$ $I_{\text{C}} = 5\text{A}$ $I_{\text{B}} = 1\text{A}$ $I_{\text{C}} = 8\text{A}$ $I_{\text{B}} = 2\text{A}$ $I_{\text{C}} = 5\text{A}$ $I_{\text{B}} = 1\text{A}$ $T_{\text{C}} = 100^{\circ}\text{C}$			0.8 1.5 2 3	V V V V
$V_{\text{BE(sat)}}^{(1)}$	Base-emitter saturation voltage	$I_{\text{C}} = 2\text{A}$ $I_{\text{B}} = 0.4\text{A}$ $I_{\text{C}} = 5\text{A}$ $I_{\text{B}} = 1\text{A}$ $I_{\text{C}} = 5\text{A}$ $I_{\text{B}} = 1\text{A}$ $T_{\text{C}} = 100^{\circ}\text{C}$			1.2 1.6 1.5	V V V
$h_{\text{FE}}$	DC current gain	$I_{\text{C}} = 2\text{A}$ $V_{\text{CE}} = 5\text{V}$ $I_{\text{C}} = 5\text{A}$ $V_{\text{CE}} = 5\text{V}$	18 8		40 25	
$V_{\text{f}}$	Diode forward voltage	$I_{\text{C}} = 3\text{A}$			2.5	V
$t_{\text{s}}$ $t_{\text{f}}$	Inductive load Storage time Fall time	$I_{\text{C}} = 5\text{A}$ $V_{\text{Clamp}} = 250\text{V}$ $I_{\text{B1}} = 1\text{A}$ $V_{\text{BE(off)}} = -5\text{V}$ $R_{\text{BB}} = 0\Omega$ $L = 200\mu\text{H}$ (see fig. 11)		1.7 90	2.3 150	$\mu\text{s}$ ns
$t_{\text{s}}$ $t_{\text{f}}$	Inductive load Storage time Fall time	$I_{\text{C}} = 5\text{A}$ $V_{\text{Clamp}} = 250\text{V}$ $I_{\text{B1}} = 1\text{A}$ $V_{\text{BE(off)}} = -5\text{V}$ $R_{\text{BB}} = 0\Omega$ $L = 200\mu\text{H}$ $T_{\text{C}} = 125^{\circ}\text{C}$ (see fig. 11)		2.2 150		$\mu\text{s}$ ns

Note (1) Pulsed duration = 300  $\mu\text{s}$ , duty cycle  $\leq 1.5\%$

## 2.1 Electrical characteristics (curves)

Figure 1. Safe operating area

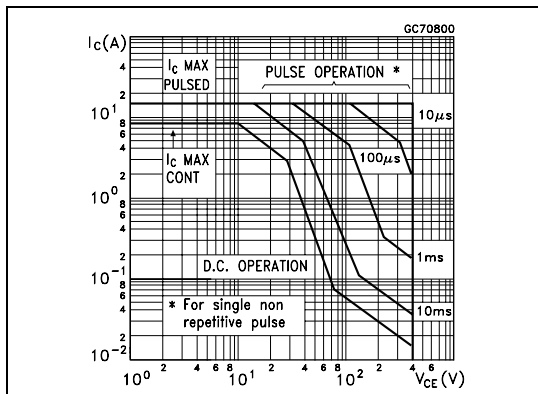

Figure 2. Derating curve

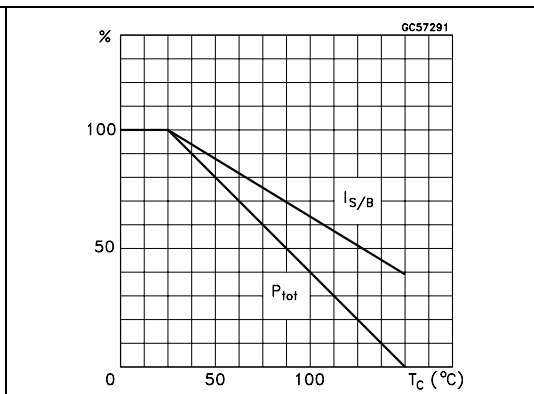

Figure 3. DC current gain

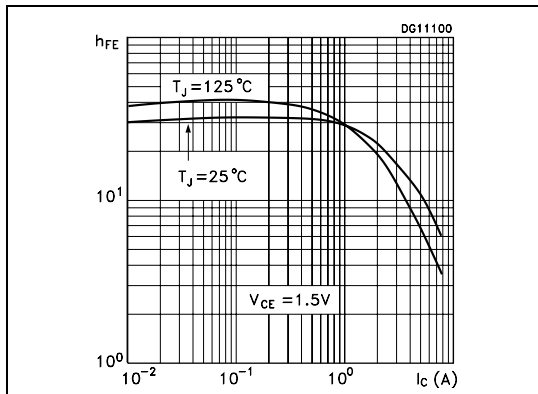

Figure 4. DC current gain

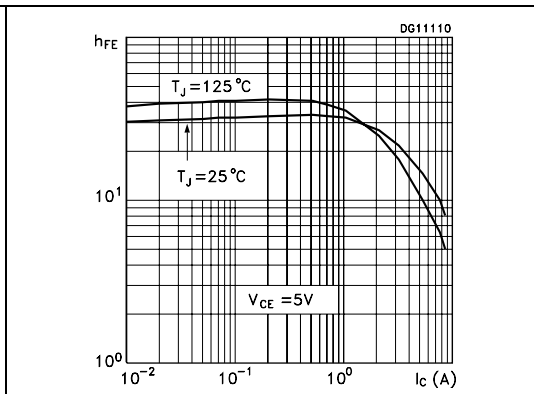

Figure 5. Collector-emitter saturation voltage

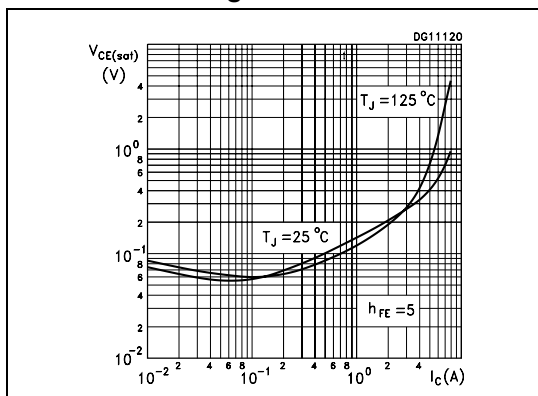

Figure 6. Base-emitter saturation voltage

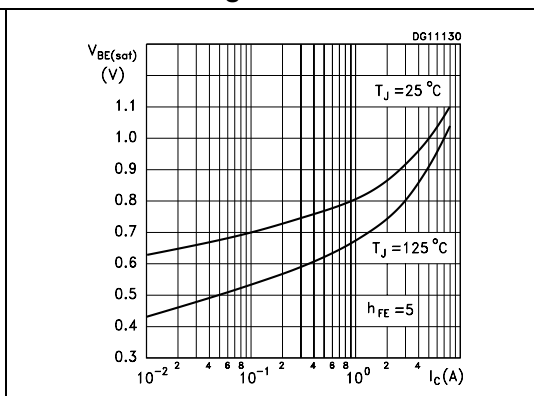

Figure 7. Diode forward voltage

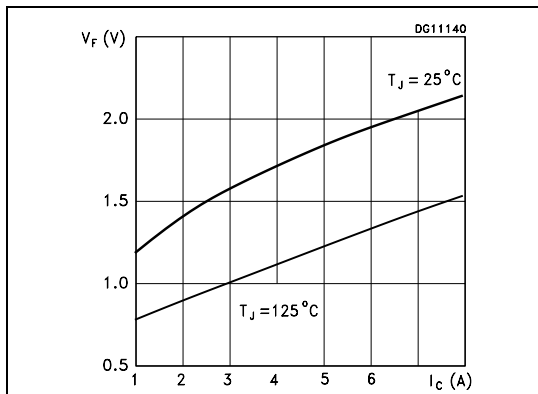

Figure 8. Switching times inductive load

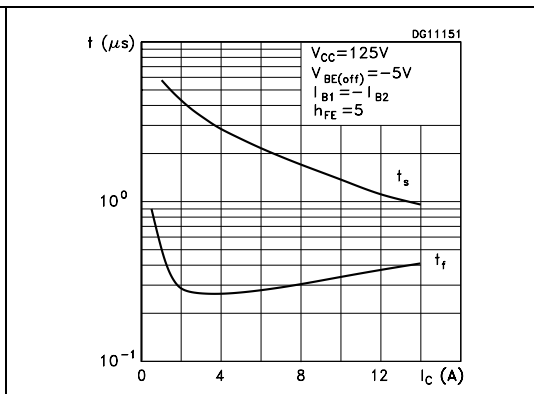

Figure 9. Switching times inductive load

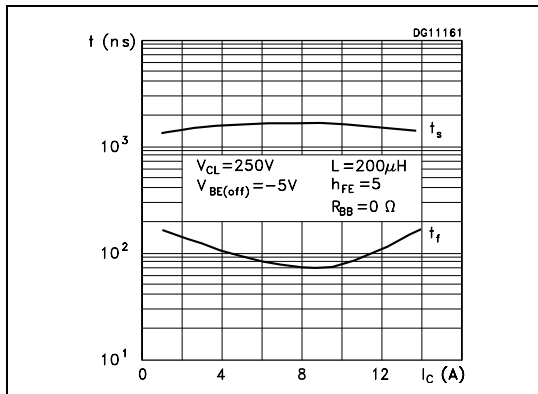
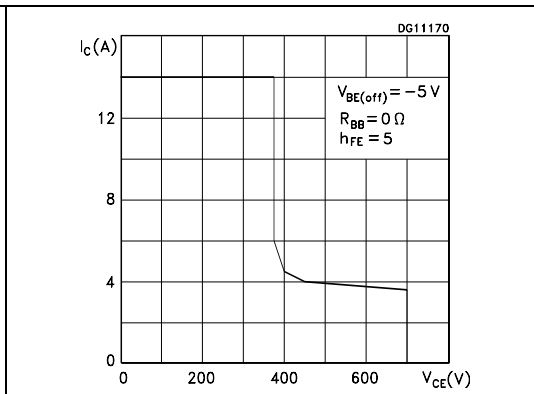
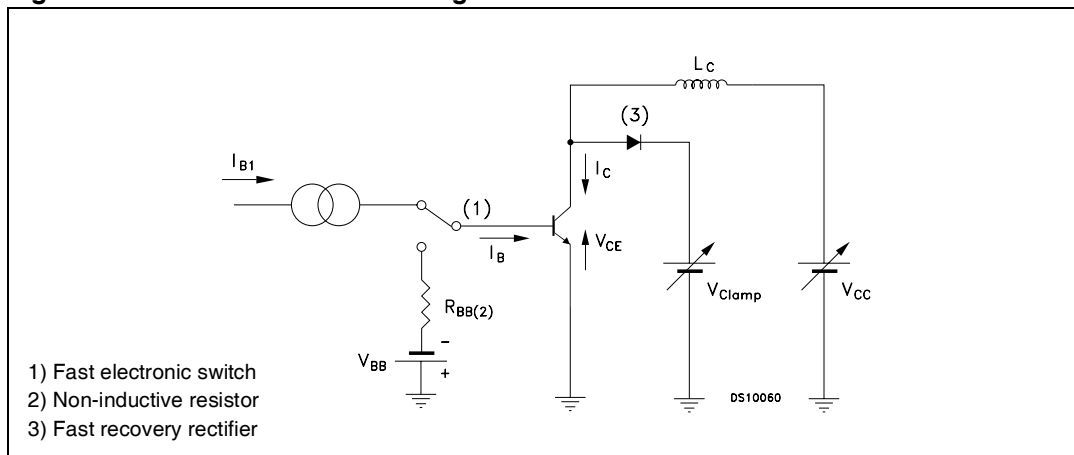

Figure 10. Reverse biased safe operating area



## 2.2 Test circuits

Figure 11. Inductive load switching test circuit



### 3 Package mechanical data

In order to meet environmental requirements, ST offers these devices in ECOPACK® packages. These packages have a Lead-free second level interconnect. The category of second level interconnect is marked on the package and on the inner box label, in compliance with JEDEC Standard JESD97. The maximum ratings related to soldering conditions are also marked on the inner box label. ECOPACK is an ST trademark. ECOPACK specifications are available at: [www.st.com](http://www.st.com)

**TO-252 (DPAK) MECHANICAL DATA**

DIM.	mm			inch		
	MIN.	TYP.	MAX.	MIN.	TYP.	MAX.
A	2.20		2.40	0.087		0.094
A1	0.90		1.10	0.035		0.043
A2	0.03		0.23	0.001		0.009
B	0.64		0.90	0.025		0.035
B2	5.20		5.40	0.204		0.213
C	0.45		0.60	0.018		0.024
C2	0.48		0.60	0.019		0.024
D	6.00		6.20	0.236		0.244
E	6.40		6.60	0.252		0.260
G	4.40		4.60	0.173		0.181
H	9.35		10.10	0.368		0.398
L2		0.8			0.031	
L4	0.60		1.00	0.024		0.039
V2	0°		8°	0°		0°

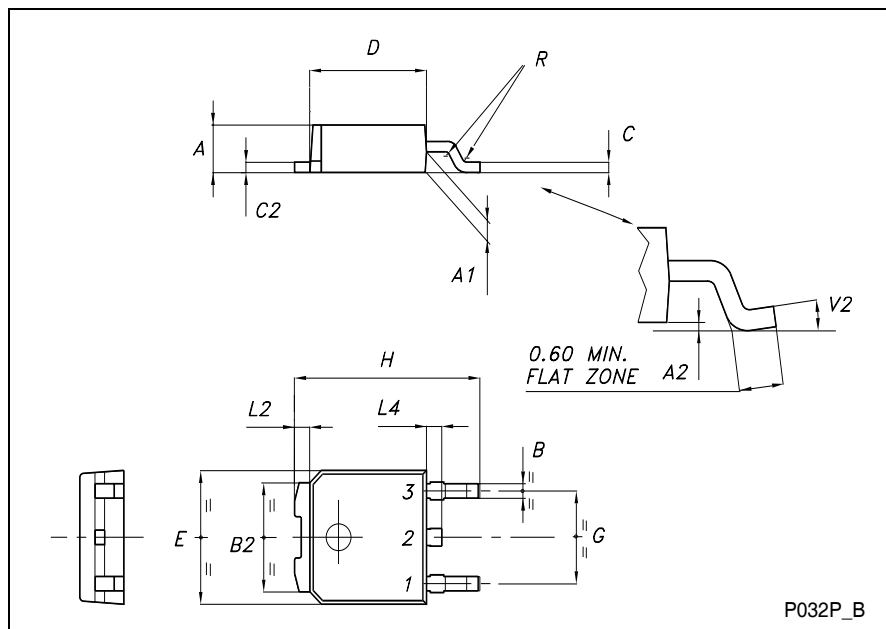



## 4 Revision history

Table 4. Revision history

Date	Revision	Changes
19-Jun-2006	1	Initial release.

**Please Read Carefully:**

Information in this document is provided solely in connection with ST products. STMicroelectronics NV and its subsidiaries ("ST") reserve the right to make changes, corrections, modifications or improvements, to this document, and the products and services described herein at any time, without notice.

All ST products are sold pursuant to ST's terms and conditions of sale.

Purchasers are solely responsible for the choice, selection and use of the ST products and services described herein, and ST assumes no liability whatsoever relating to the choice, selection or use of the ST products and services described herein.

No license, express or implied, by estoppel or otherwise, to any intellectual property rights is granted under this document. If any part of this document refers to any third party products or services it shall not be deemed a license grant by ST for the use of such third party products or services, or any intellectual property contained therein or considered as a warranty covering the use in any manner whatsoever of such third party products or services or any intellectual property contained therein.

**UNLESS OTHERWISE SET FORTH IN ST'S TERMS AND CONDITIONS OF SALE ST DISCLAIMS ANY EXPRESS OR IMPLIED WARRANTY WITH RESPECT TO THE USE AND/OR SALE OF ST PRODUCTS INCLUDING WITHOUT LIMITATION IMPLIED WARRANTIES OF MERCHANTABILITY, FITNESS FOR A PARTICULAR PURPOSE (AND THEIR EQUIVALENTS UNDER THE LAWS OF ANY JURISDICTION), OR INFRINGEMENT OF ANY PATENT, COPYRIGHT OR OTHER INTELLECTUAL PROPERTY RIGHT.**

**UNLESS EXPRESSLY APPROVED IN WRITING BY AN AUTHORIZED REPRESENTATIVE OF ST, ST PRODUCTS ARE NOT DESIGNED, AUTHORIZED OR WARRANTED FOR USE IN MILITARY, AIR CRAFT, SPACE, LIFE SAVING, OR LIFE SUSTAINING APPLICATIONS, NOR IN PRODUCTS OR SYSTEMS, WHERE FAILURE OR MALFUNCTION MAY RESULT IN PERSONAL INJURY, DEATH, OR SEVERE PROPERTY OR ENVIRONMENTAL DAMAGE.**

Resale of ST products with provisions different from the statements and/or technical features set forth in this document shall immediately void any warranty granted by ST for the ST product or service described herein and shall not create or extend in any manner whatsoever, any liability of ST.

ST and the ST logo are trademarks or registered trademarks of ST in various countries.

Information in this document supersedes and replaces all information previously supplied.

The ST logo is a registered trademark of STMicroelectronics. All other names are the property of their respective owners.

© 2006 STMicroelectronics - All rights reserved

STMicroelectronics group of companies

Australia - Belgium - Brazil - Canada - China - Czech Republic - Finland - France - Germany - Hong Kong - India - Israel - Italy - Japan - Malaysia - Malta - Morocco - Singapore - Spain - Sweden - Switzerland - United Kingdom - United States of America

[www.st.com](http://www.st.com)