

SMF05T1

Quad Array for ESD Protection

ESD Protection Diodes with Low Clamping Voltage

This quad monolithic silicon voltage suppressor is designed for applications requiring transient overvoltage protection capability. It is intended for use in voltage and ESD sensitive equipment such as computers, printers, business machines, communication systems, medical equipment, and other applications. Its quad junction common anode design protects four separate lines using only one package. These devices are ideal for situations where board space is at a premium.

Specification Features

- Low Clamping Voltage
- Stand Off Voltage 5 V
- Low Leakage < 5 μ A @ 5 V
- SC-88A Package Allows Four Separate Unidirectional Configurations
- IEC6100-4-2 Level 4 ESD Protection
- Pb-Free Packages are Available*

Mechanical Characteristics

- Void Free, Transfer-Molded, Thermosetting Plastic Case
- Corrosion Resistant Finish, Easily Solderable
- Package Designed for Optimal Automated Board Assembly
- Small Package Size for High Density Applications

MAXIMUM RATINGS ($T_A = 25^\circ\text{C}$ unless otherwise noted)

| Characteristic | Symbol | Value | Unit |
|---|-----------------|-------------|---|
| Peak Power Dissipation @ 8 X 20 μ s @ $T_A \leq 25^\circ\text{C}$ | P_{pk} | 200 | W |
| Steady State Power – 1 Diode (Note 1) | P_D | 385 | mW |
| Thermal Resistance Junction-to-Ambient Above 25 $^\circ\text{C}$, Derate | $R_{\theta JA}$ | 325 3.1 | $^\circ\text{C}/\text{W}$ $\text{mW}/^\circ\text{C}$ |
| Maximum Junction Temperature | T_{Jmax} | 150 | $^\circ\text{C}$ |
| Operating Junction and Storage Temperature Range | $T_J T_{stg}$ | -55 to +150 | $^\circ\text{C}$ |
| ESD Discharge IEC61000-4-2, Air Discharge IEC61000-4-2, Contact Discharge | | 30 30 | kV |
| Lead Solder Temperature (10 seconds duration) | T_L | 260 | $^\circ\text{C}$ |

Stresses exceeding Maximum Ratings may damage the device. Maximum Ratings are stress ratings only. Functional operation above the Recommended Operating Conditions is not implied. Extended exposure to stresses above the Recommended Operating Conditions may affect device reliability.

1. Only 1 diode under power. For all 4 diodes under power, P_D will be 25%. Mounted on FR-4 board with min pad.

*For additional information on our Pb-Free strategy and soldering details, please download the ON Semiconductor Soldering and Mounting Techniques Reference Manual, SOLDERRM/D.

See Application Note AND8308/D for further description of survivability specs.



ON Semiconductor®

<http://onsemi.com>



SC-88A/SOT-323
CASE 419A
STYLE 5

MARKING DIAGRAM

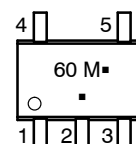

60 = Device Marking
M = One Digit Date Code
■ = Pb-Free Package
(Note: Microdot may be in either location)

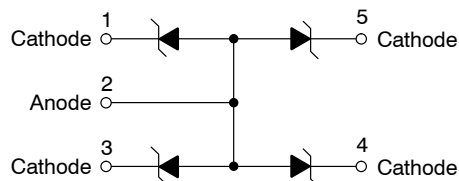

ORDERING INFORMATION

| Device | Package | Shipping† |
|----------|---------------------|------------------|
| SMF05T1 | SC-88A | 3000/Tape & Reel |
| SMF05T1G | SC-88A (Pb-Free) | 3000/Tape & Reel |
| SMF05T2G | SC-88A (Pb-Free) | 3000/Tape & Reel |

†For information on tape and reel specifications, including part orientation and tape sizes, please refer to our Tape and Reel Packaging Specifications Brochure, BRD8011/D.

ELECTRICAL CHARACTERISTICS

(T_A = 25°C unless otherwise noted)

| Symbol | Parameter |
|------------------|--|
| I _{PP} | Maximum Reverse Peak Pulse Current |
| V _C | Clamping Voltage @ I _{PP} |
| V _{RWM} | Working Peak Reverse Voltage |
| I _R | Maximum Reverse Leakage Current @ V _{RWM} |
| V _{BR} | Breakdown Voltage @ I _T |
| I _T | Test Current |
| I _F | Forward Current |
| V _F | Forward Voltage @ I _F |
| P _{pk} | Peak Power Dissipation |
| C | Capacitance @ V _R = 0 and f = 1.0 MHz |

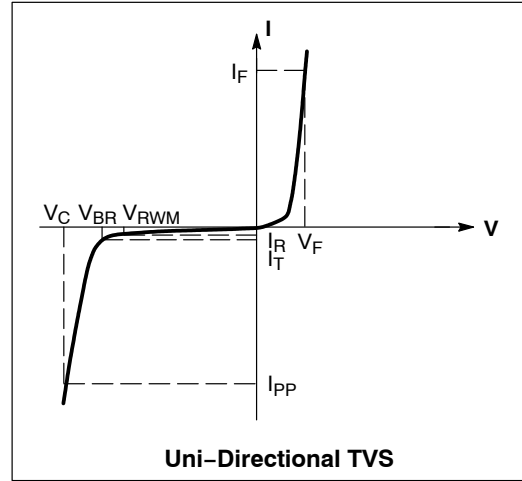

*See Application Note AND8308/D for detailed explanations of datasheet parameters.

ELECTRICAL CHARACTERISTICS

| Device | Breakdown Voltage V _{BR} @ 1 mA (V) | | Leakage Current I _R @ V _{RWM} = 5 V (μA) | Capacitance @ 0 V Bias (pF) | Max V _F @ I _F = 200 mA (V) | Max Clamping Voltage (V _C) @ I _{PP} (Note 2) | | Max Clamping Voltage (V _C) @ I _{PP} (Note 2) | | V _C Per IEC61000-4-2 (Note 3) Figures 1 and 2 See Below |
|--------|--|-----|--|-----------------------------------|--|---|--------------------|---|--------------------|--|
| | Min | Max | Max | Max | | I _{PP} (A) | V _C (V) | I _{PP} (A) | V _C (V) | |
| SMF05 | 6.0 | 7.2 | 5.0 | 90 | 1.25 | 1.0 | 9.5 | 12 | 12.5 | |

2. Non-repetitive current per Figure 5. Derate per Figure 6.
3. For test procedure see Figures 3 and 4 and Application Note AND8307/D.

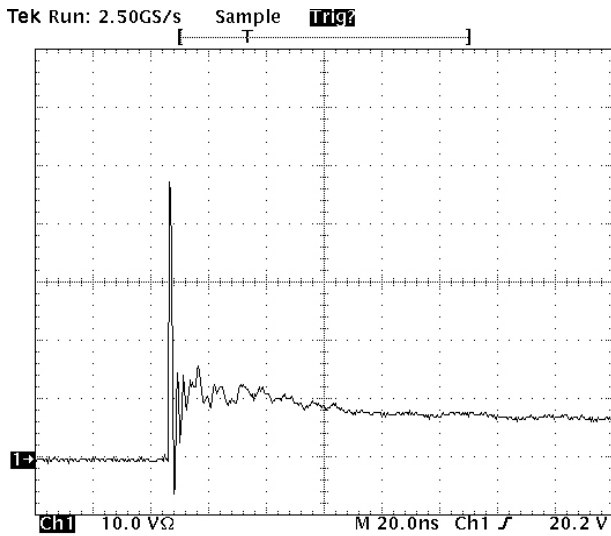

**Figure 1. ESD Clamping Voltage Screenshot
Positive 8 kV Contact per IEC61000-4-2**

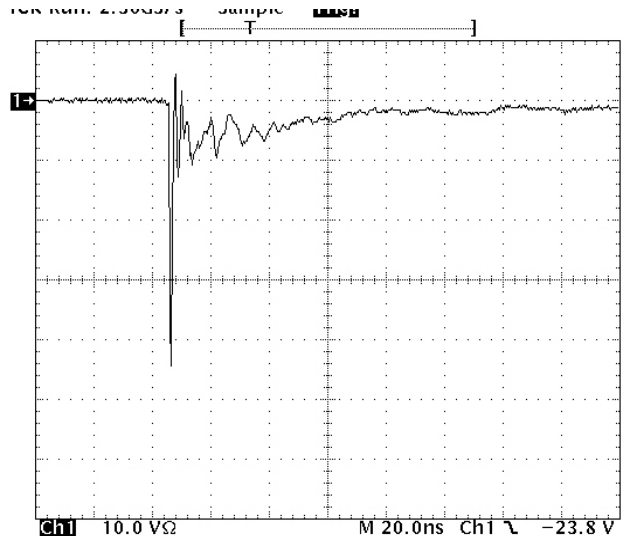

**Figure 2. ESD Clamping Voltage Screenshot
Negative 8 kV Contact per IEC61000-4-2**

SMF05T1

IEC 61000-4-2 Spec.

| Level | Test Voltage (kV) | First Peak Current (A) | Current at 30 ns (A) | Current at 60 ns (A) |
|-------|-------------------|------------------------|----------------------|----------------------|
| 1 | 2 | 7.5 | 4 | 2 |
| 2 | 4 | 15 | 8 | 4 |
| 3 | 6 | 22.5 | 12 | 6 |
| 4 | 8 | 30 | 16 | 8 |

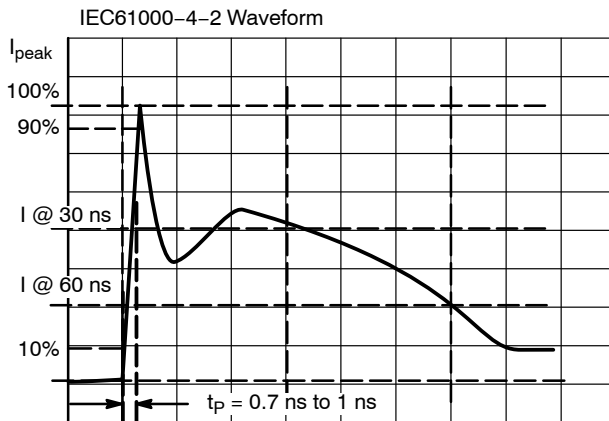

Figure 3. IEC61000-4-2 Spec

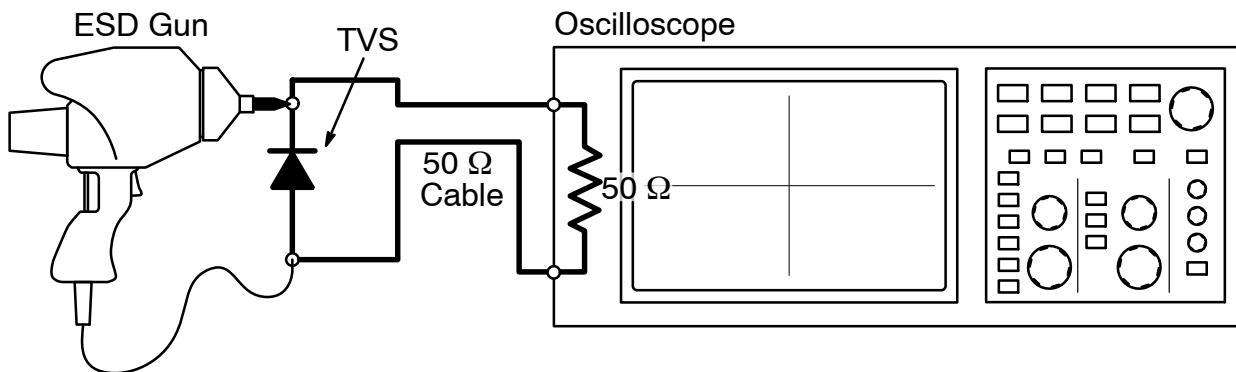

Figure 4. Diagram of ESD Test Setup

The following is taken from Application Note AND8308/D – Interpretation of Datasheet Parameters for ESD Devices.

ESD Voltage Clamping

For sensitive circuit elements it is important to limit the voltage that an IC will be exposed to during an ESD event to as low a voltage as possible. The ESD clamping voltage is the voltage drop across the ESD protection diode during an ESD event per the IEC61000-4-2 waveform. Since the IEC61000-4-2 was written as a pass/fail spec for larger

systems such as cell phones or laptop computers it is not clearly defined in the spec how to specify a clamping voltage at the device level. ON Semiconductor has developed a way to examine the entire voltage waveform across the ESD protection diode over the time domain of an ESD pulse in the form of an oscilloscope screenshot, which can be found on the datasheets for all ESD protection diodes. For more information on how ON Semiconductor creates these screenshots and how to interpret them please refer to AND8307/D.

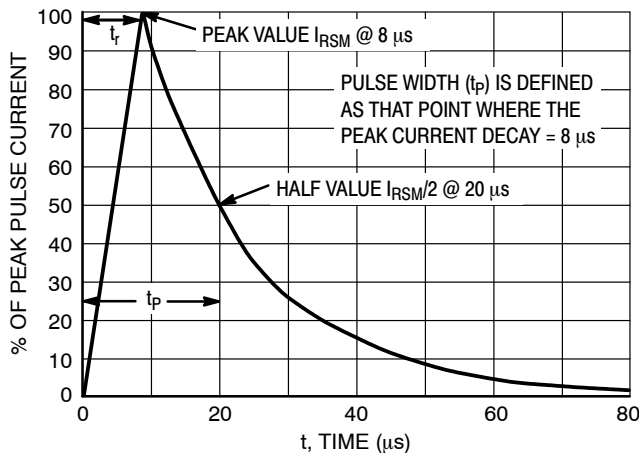

Figure 5. 8 X 20 μs Pulse Waveform

SMF05T1

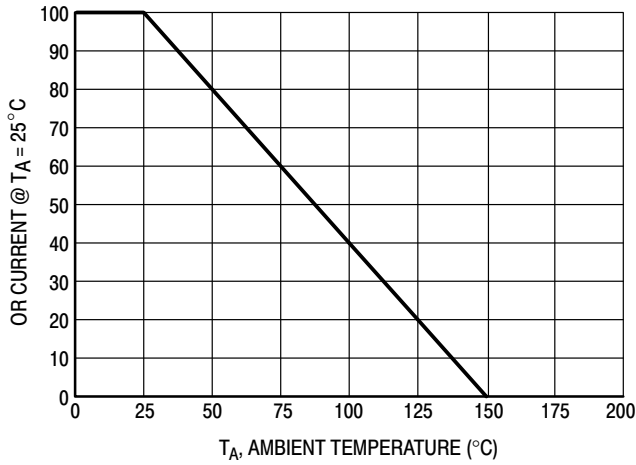

Figure 6. Pulse Derating Curve

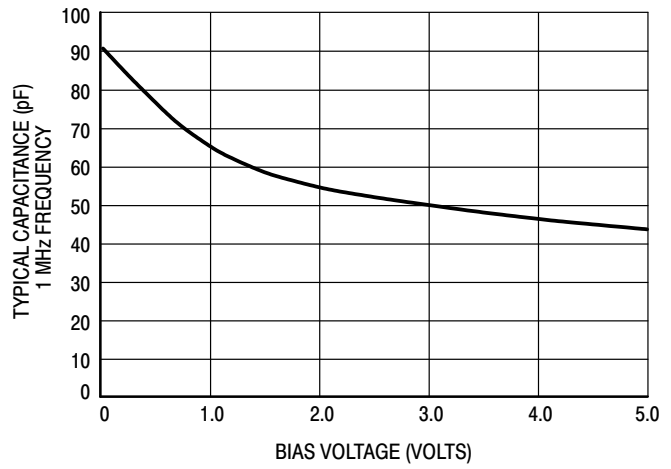

Figure 7. Capacitance

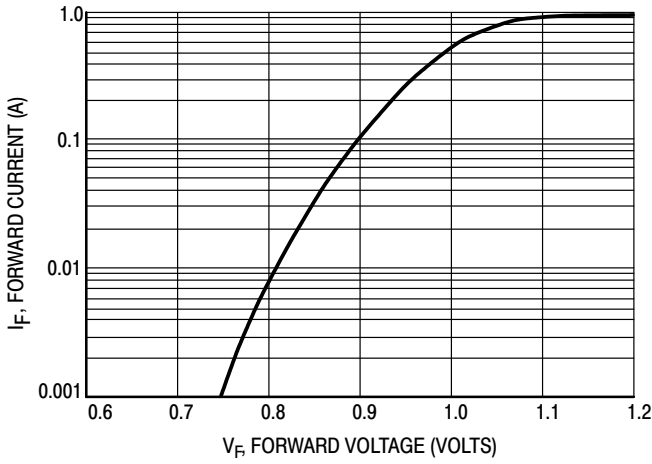

Figure 8. Forward Voltage

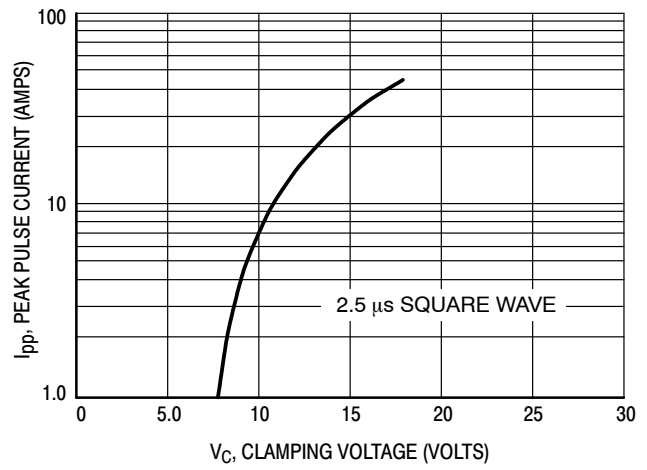

Figure 9. Clamping Voltage versus Peak Pulse Current (Reverse Direction)

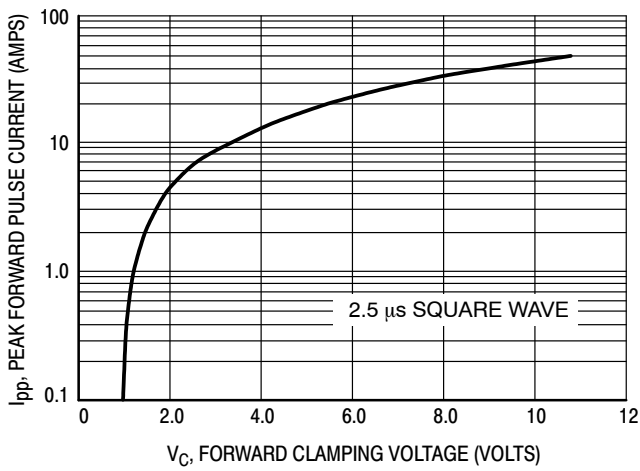

Figure 10. Clamping Voltage versus Peak Pulse Current (Forward Direction)

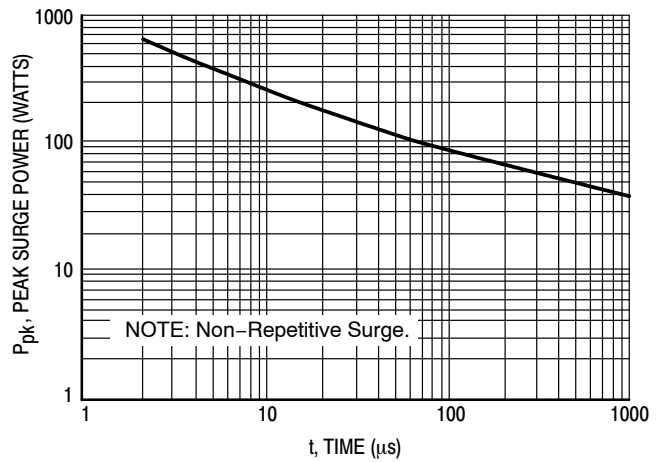
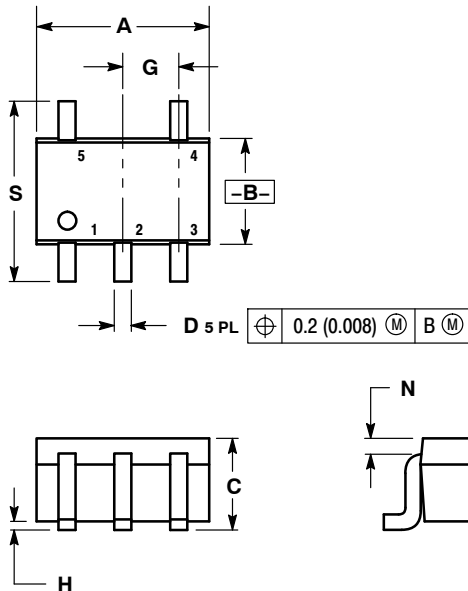

Figure 11. Pulse Width

SMF05T1

PACKAGE DIMENSIONS

SC-88A/SOT-353/SC-70
5-LEAD PACKAGE
CASE 419A-02
ISSUE J



NOTES:

1. DIMENSIONING AND TOLERANCING PER ANSI Y14.5M, 1982.
2. CONTROLLING DIMENSION: INCH.
3. 419A-01 OBSOLETE. NEW STANDARD 419A-02.
4. DIMENSIONS A AND B DO NOT INCLUDE MOLD FLASH, PROTRUSIONS, OR GATE BURRS.

| DIM | INCHES | | MILLIMETERS | |
|-----|-----------|-------|-------------|------|
| | MIN | MAX | MIN | MAX |
| A | 0.071 | 0.087 | 1.80 | 2.20 |
| B | 0.045 | 0.053 | 1.15 | 1.35 |
| C | 0.031 | 0.043 | 0.80 | 1.10 |
| D | 0.004 | 0.012 | 0.10 | 0.30 |
| G | 0.026 BSC | | 0.65 BSC | |
| H | --- | 0.004 | --- | 0.10 |
| J | 0.004 | 0.010 | 0.10 | 0.25 |
| K | 0.004 | 0.012 | 0.10 | 0.30 |
| N | 0.008 REF | | 0.20 REF | |
| S | 0.079 | 0.087 | 2.00 | 2.20 |

STYLE 5:

1. CATHODE
2. COMMON ANODE
3. CATHODE 2
4. CATHODE 3
5. CATHODE 4

ON Semiconductor and are registered trademarks of Semiconductor Components Industries, LLC (SCILLC). SCILLC reserves the right to make changes without further notice to any products herein. SCILLC makes no warranty, representation or guarantee regarding the suitability of its products for any particular purpose, nor does SCILLC assume any liability arising out of the application or use of any product or circuit, and specifically disclaims any and all liability, including without limitation special, consequential or incidental damages. "Typical" parameters which may be provided in SCILLC data sheets and/or specifications can and do vary in different applications and actual performance may vary over time. All operating parameters, including "Typicals" must be validated for each customer application by customer's technical experts. SCILLC does not convey any license under its patent rights nor the rights of others. SCILLC products are not designed, intended, or authorized for use as components in systems intended for surgical implant into the body, or other applications intended to support or sustain life, or for any other application in which the failure of the SCILLC product could create a situation where personal injury or death may occur. Should Buyer purchase or use SCILLC products for any such unintended or unauthorized application, Buyer shall indemnify and hold SCILLC and its officers, employees, subsidiaries, affiliates, and distributors harmless against all claims, costs, damages, and expenses, and reasonable attorney fees arising out of, directly or indirectly, any claim of personal injury or death associated with such unintended or unauthorized use, even if such claim alleges that SCILLC was negligent regarding the design or manufacture of the part. SCILLC is an Equal Opportunity/Affirmative Action Employer. This literature is subject to all applicable copyright laws and is not for resale in any manner.

PUBLICATION ORDERING INFORMATION

LITERATURE FULFILLMENT:

Literature Distribution Center for ON Semiconductor
P.O. Box 5163, Denver, Colorado 80217 USA
Phone: 303-675-2175 or 800-344-3860 Toll Free USA/Canada
Fax: 303-675-2176 or 800-344-3867 Toll Free USA/Canada
Email: orderlit@onsemi.com

N. American Technical Support: 800-282-9855 Toll Free
USA/Canada
Europe, Middle East and Africa Technical Support:
Phone: 421 33 790 2910
Japan Customer Focus Center
Phone: 81-3-5773-3850

ON Semiconductor Website: www.onsemi.com

Order Literature: <http://www.onsemi.com/orderlit>

For additional information, please contact your local Sales Representative