

SL05T1G Series

300 Watt, SOT-23 Low Capacitance TVS for High Speed Line Protections

This family of TVS offers transient overvoltage protection with significantly reduced capacitance. The capacitance is lowered by integrating a compensating diode in series. This integrated solution offers ESD protection for high speed interfaces such as communication systems, computers, and computer peripherals.

Features

- TVS Diode in Series with a Compensating Diode Offers <5 pF Capacitance
- ESD Protection Meeting IEC 61000-4-2, 4-4, 4-5
- Peak Power Rating of 300 W, 8 × 20 μs
- Bi-Direction Protection Can Be Achieved By Using Two Devices
- Flammability Rating UL 94 V-0
- SZ Prefix for Automotive and Other Applications Requiring Unique Site and Control Change Requirements; AEC-Q101 Qualified and PPAP Capable
- These Devices are Pb-Free, Halogen Free/BFR Free and are RoHS Compliant

Mechanical Characteristics:

CASE: Void-free, transfer-molded, thermosetting plastic case

FINISH: Corrosion resistant finish, easily solderable

MAXIMUM CASE TEMPERATURE FOR SOLDERING PURPOSES:

260°C for 10 Seconds

Package designed for optimal automated board assembly

Small package size for high density applications

Available in 8 mm Tape and Reel

Use the Device Number to order the 7 inch/3,000 unit reel.

Replace the “T1” with “T3” in the Device Number to order the

13 inch/10,000 unit reel.



ON Semiconductor®

www.onsemi.com

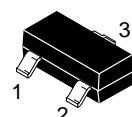
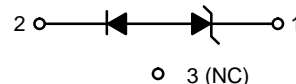

SOT-23 (TO-236)
CASE 318
STYLE 26

MARKING DIAGRAM

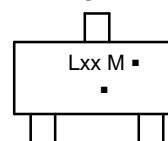

Lxx = Device Code
xx = 05, 12, 15, or 24
M = Date Code*
▪ = Pb-Free Package

(Note: Microdot may be in either location)

*Date Code orientation and/or overbar may vary depending upon manufacturing location.

ORDERING INFORMATION

Device	Package	Shipping†
SL05T1G	SOT-23 (Pb-Free)	3000/Tape & Reel
SZSL05T1G	SOT-23 (Pb-Free)	3000/Tape & Reel
SL12T1G	SOT-23 (Pb-Free)	3000/Tape & Reel
SZSL12T1G	SOT-23 (Pb-Free)	3000/Tape & Reel
SL15T1G	SOT-23 (Pb-Free)	3000/Tape & Reel
SZSL15T1G	SOT-23 (Pb-Free)	3000/Tape & Reel
SL24T1G	SOT-23 (Pb-Free)	3000/Tape & Reel
SZSL24T1G	SOT-23 (Pb-Free)	3000/Tape & Reel

†For information on tape and reel specifications, including part orientation and tape sizes, please refer to our Tape and Reel Packaging Specifications Brochure, BRD8011/D.

DEVICE MARKING INFORMATION

See specific marking information in the device marking column of the table on page 2 of this data sheet.

SL05T1G Series

MAXIMUM RATINGS

Rating	Symbol	Value	Unit
Peak Power Dissipation @ 8x20 usec (Note 1) @ $T_L \leq 25^\circ\text{C}$	P_{pk}	300	W
IEC 61000-4-2 Level 4 Contact Discharge	V_{pp}	± 8	kV
Air Discharge		± 16	kV
IEC 61000-4-4 EFT		40	A
IEC 61000-4-5 Lightning		12	A
Total Power Dissipation on FR-5 Board (Note 2) @ $T_A = 25^\circ\text{C}$ Derate above 25°C	P_D	225	mW
		1.8	mW/ $^\circ\text{C}$
Thermal Resistance Junction to Ambient	$R_{\theta JA}$	556	$^\circ\text{C/W}$
Total Power Dissipation on Alumina Substrate (Note 3) @ $T_A = 25^\circ\text{C}$ Derate above 25°C	P_D	300	mW
		2.4	mW/ $^\circ\text{C}$
Thermal Resistance Junction-to-Ambient	$R_{\theta JA}$	417	$^\circ\text{C/W}$
Junction and Storage Temperature Range	T_J, T_{stg}	- 55 to +150	$^\circ\text{C}$
Lead Solder Temperature – Maximum (10 Second Duration)	T_L	260	$^\circ\text{C}$

Stresses exceeding those listed in the Maximum Ratings table may damage the device. If any of these limits are exceeded, device functionality should not be assumed, damage may occur and reliability may be affected.

1. Non-repetitive current pulse per Figure 2
2. FR-5 = 1.0 x 0.75 x 0.62 in.
3. Alumina = 0.4 x 0.3 x 0.024 in., 99.5% alumina

ELECTRICAL CHARACTERISTICS

($T_A = 25^\circ\text{C}$ unless otherwise noted)

UNIDIRECTIONAL

Symbol	Parameter
I_{PP}	Maximum Reverse Peak Pulse Current
V_C	Clamping Voltage @ I_{PP}
V_{RWM}	Working Peak Reverse Voltage
I_R	Maximum Reverse Leakage Current @ V_{RWM}
V_{BR}	Breakdown Voltage @ I_T
I_T	Test Current
ΘV_{BR}	Maximum Temperature Coefficient of V_{BR}
I_F	Forward Current
V_F	Forward Voltage @ I_F
Z_{ZT}	Maximum Zener Impedance @ I_{ZT}
I_{ZK}	Reverse Current
Z_{ZK}	Maximum Zener Impedance @ I_{ZK}

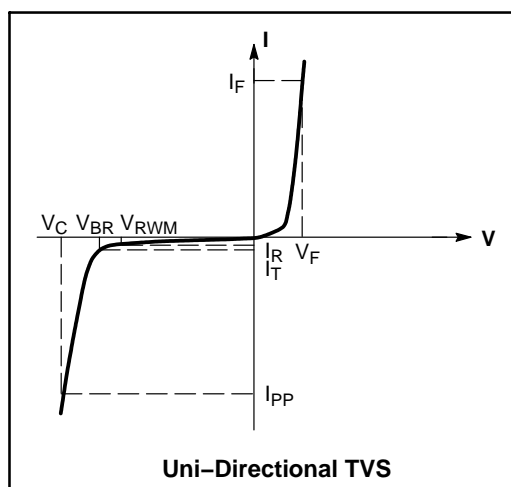

ELECTRICAL CHARACTERISTICS

Device	Device Marking	V_{RWM} (V)	I_R @ V_{RWM} (μA)	Breakdown Voltage (Note 4)		V_C , Clamping Voltage (Note 5)		Max I_{PP} (A)	Capacitance @ $V_R = 0\text{ V}, 1\text{ MHz}$ (pF)	
				V_{BR} @ 1 mA (Volts)		@ 1 A	@ 5 A		Typ	Max
				Min	Max	(V)	(V)			
SL05	L05	5.0	20	6.0	8.0	9.8	11	17	3.5	5.0
SL12	L12	12	1.0	13.3	15.5	19	24	12	3.5	5.0
SL15	L15	15	1.0	16.7	18.5	24	30	10	3.5	5.0
SL24	L24	24	1.0	26.7	29	43	55	5.0	3.5	5.0

Product parametric performance is indicated in the Electrical Characteristics for the listed test conditions, unless otherwise noted. Product performance may not be indicated by the Electrical Characteristics if operated under different conditions.

4. V_{BR} measured at pulse test current of 1 mA at an ambient temperature of 25°C
5. Surge current waveform per Figure 2

SL05T1G Series

TYPICAL CHARACTERISTICS

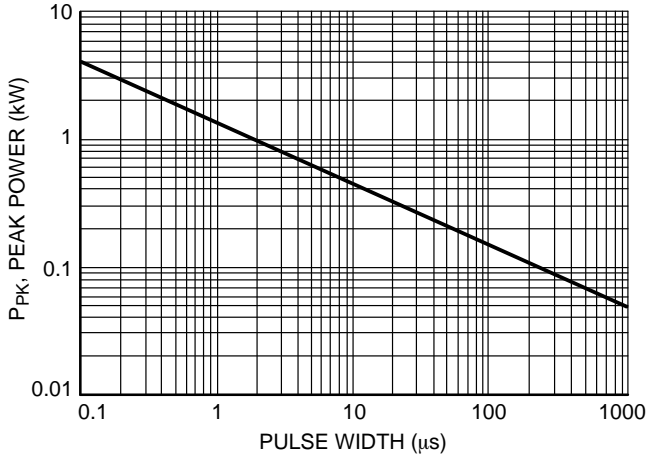

Figure 1. Maximum Peak Power Rating

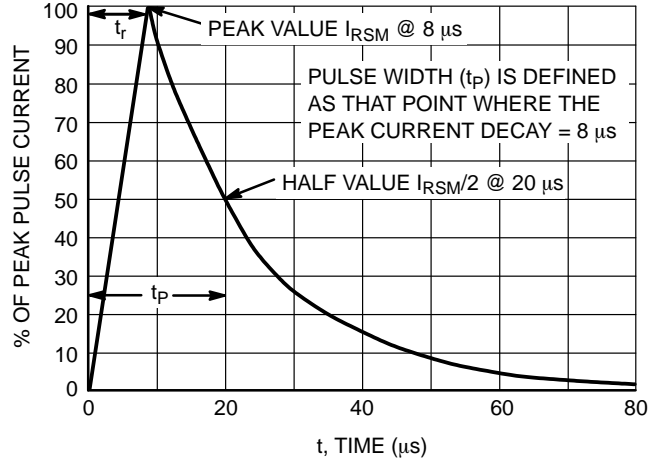

Figure 2. 8 x 20 μs Pulse Waveform

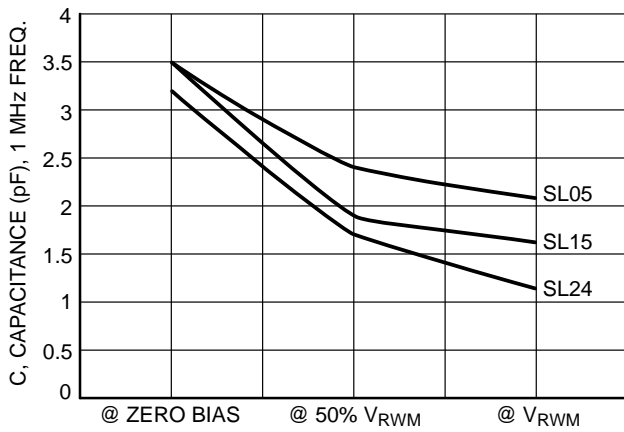

Figure 3. Typical Junction Capacitance

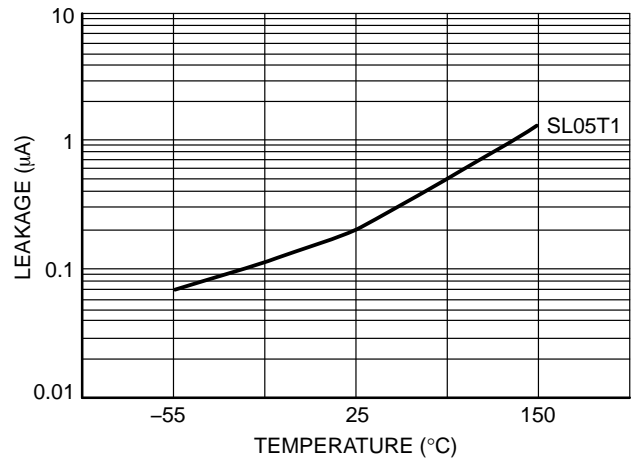

Figure 4. Typical Leakage Over Temperature

SL05T1G Series

Applications Background

This family of TVS devices (SL05T1 series) are designed to protect sensitive electronics such as communications systems, computers, and computer peripherals against damage due to ESD conditions or transient voltage conditions. Because of their low capacitance value (less than 5 pF), they can be used in high speed I/O data lines. Low capacitance is achieved by integrating a compensating diode in series with the TVS which is basically based in the below theoretical principle:

- Capacitance in parallel: $C_T = C_1 + C_2 + \dots + C_n$
- Capacitance in series: $1/C_T = (1/C_1) + (1/C_2) + \dots + (1/C_n)$

The Figure 5 shows the integrated solution of the SL05T1 series device:

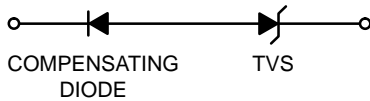

Figure 5.

In the case that an over-voltage condition occurs in the I/O line protected by the SL05T1 series device, the TVS is reversed-biased while the compensation diode is forward-biased so the resulting current due to the transient voltage is drained to ground.

If protection in both polarities is required, an additional device is connected in inverse-parallel with reference to the first one, the Figure 6 illustrates the inverse-parallel connection for bi-directional or unidirectional lines:

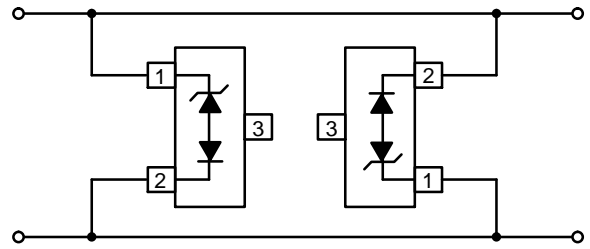

Figure 6.

An alternative solution to protect unidirectional lines, is to connect a fast switching steering diode in parallel with the SL05T1 series device. When the steering diode is forward-biased, the TVS will avalanche and conduct in reverse direction. It is important to note that by adding a steering diode, the effective capacitance in the circuit will be increased, therefore the impact of adding a steering diode must be taken in consideration to establish whether the incremental capacitance will affect the circuit functionality or not. The Figure 7 shows the connection between the steering diode and the SL05T1 series device:

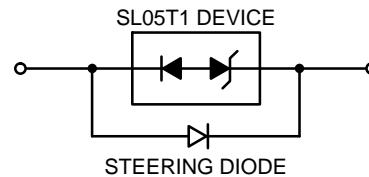

Figure 7.

Another typical application in which the SL05T1 series device can be utilized, is to protect multiple I/O lines. The protection in each of the I/O lines is achieved by connecting two devices in inverse-parallel. The Figure 8 illustrates how multiple I/O line protection is achieved:

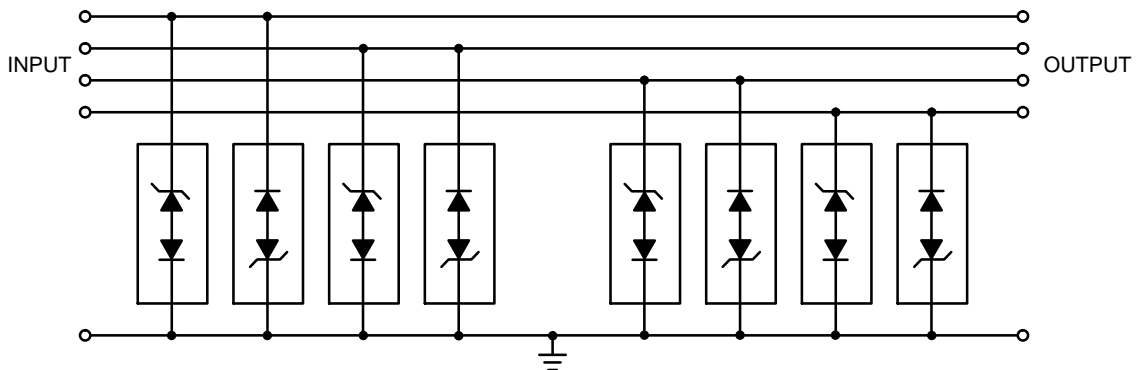

Figure 8.

For optimizing the protection, it is recommended to use ground planes and short path lengths to minimize the PCB's ground inductance.

SL05T1G Series

PACKAGE DIMENSIONS

SOT-23 (TO-236)
CASE 318-08
ISSUE AR

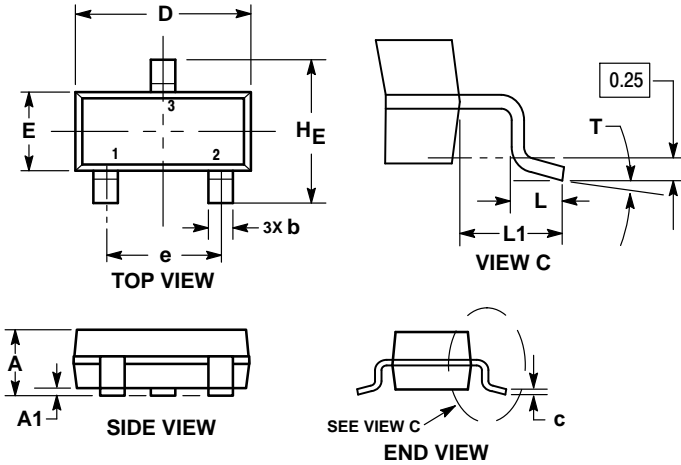

NOTES:

1. DIMENSIONING AND TOLERANCING PER ASME Y14.5M, 1994.
2. CONTROLLING DIMENSION: MILLIMETERS.
3. MAXIMUM LEAD THICKNESS INCLUDES LEAD FINISH. MINIMUM LEAD THICKNESS IS THE MINIMUM THICKNESS OF THE BASE MATERIAL.
4. DIMENSIONS D AND E DO NOT INCLUDE MOLD FLASH, PROTRUSIONS, OR GATE BURRS.

DIM	MILLIMETERS			INCHES		
	MIN	NOM	MAX	MIN	NOM	MAX
A	0.89	1.00	1.11	0.035	0.039	0.044
A1	0.01	0.06	0.10	0.000	0.002	0.004
b	0.37	0.44	0.50	0.015	0.017	0.020
c	0.08	0.14	0.20	0.003	0.006	0.008
D	2.80	2.90	3.04	0.110	0.114	0.120
E	1.20	1.30	1.40	0.047	0.051	0.055
e	1.78	1.90	2.04	0.070	0.075	0.080
L	0.30	0.43	0.55	0.012	0.017	0.022
L1	0.35	0.54	0.69	0.014	0.021	0.027
HE	2.10	2.40	2.64	0.083	0.094	0.104
T	0°	—	10°	0°	—	10°

STYLE 26:

1. CATHODE
2. ANODE
3. NO CONNECTION

RECOMMENDED SOLDERING FOOTPRINT*

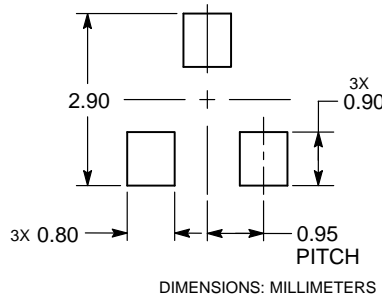

*For additional information on our Pb-Free strategy and soldering details, please download the ON Semiconductor Soldering and Mounting Techniques Reference Manual, SOLDERRM/D.

ON Semiconductor and are trademarks of Semiconductor Components Industries, LLC dba ON Semiconductor or its subsidiaries in the United States and/or other countries. ON Semiconductor owns the rights to a number of patents, trademarks, copyrights, trade secrets, and other intellectual property. A listing of ON Semiconductor's product/patent coverage may be accessed at www.onsemi.com/site/pdf/Patent-Marking.pdf. ON Semiconductor reserves the right to make changes without further notice to any products herein. ON Semiconductor makes no warranty, representation or guarantee regarding the suitability of its products for any particular purpose, nor does ON Semiconductor assume any liability arising out of the application or use of any product or circuit, and specifically disclaims any and all liability, including without limitation special, consequential or incidental damages. Buyer is responsible for its products and applications using ON Semiconductor products, including compliance with all laws, regulations and safety requirements or standards, regardless of any support or applications information provided by ON Semiconductor. "Typical" parameters which may be provided in ON Semiconductor data sheets and/or specifications can and do vary in different applications and actual performance may vary over time. All operating parameters, including "Typicals" must be validated for each customer application by customer's technical experts. ON Semiconductor does not convey any license under its patent rights nor the rights of others. ON Semiconductor products are not designed, intended, or authorized for use as a critical component in life support systems or any FDA Class 3 medical devices or medical devices with a same or similar classification in a foreign jurisdiction or any devices intended for implantation in the human body. Should Buyer purchase or use ON Semiconductor products for any such unintended or unauthorized application, Buyer shall indemnify and hold ON Semiconductor and its officers, employees, subsidiaries, affiliates, and distributors harmless against all claims, costs, damages, and expenses, and reasonable attorney fees arising out of, directly or indirectly, any claim of personal injury or death associated with such unintended or unauthorized use, even if such claim alleges that ON Semiconductor was negligent regarding the design or manufacture of the part. ON Semiconductor is an Equal Opportunity/Affirmative Action Employer. This literature is subject to all applicable copyright laws and is not for resale in any manner.

PUBLICATION ORDERING INFORMATION

LITERATURE FULFILLMENT:
Literature Distribution Center for ON Semiconductor
19521 E. 32nd Pkwy, Aurora, Colorado 80011 USA
Phone: 303-675-2175 or 800-344-3860 Toll Free USA/Canada
Fax: 303-675-2176 or 800-344-3867 Toll Free USA/Canada
Email: orderlit@onsemi.com

N. American Technical Support: 800-282-9855 Toll Free USA/Canada
Europe, Middle East and Africa Technical Support:
Phone: 421 33 790 2910
Japan Customer Focus Center
Phone: 81-3-5817-1050

ON Semiconductor Website: www.onsemi.com
Order Literature: <http://www.onsemi.com/orderlit>

For additional information, please contact your local Sales Representative