

SGH40N60UFD

Ultra-Fast IGBT

General Description

Fairchild's UFD series of Insulated Gate Bipolar Transistors (IGBTs) provides low conduction and switching losses. The UFD series is designed for applications such as motor control and general inverters where high speed switching is a required feature.

Features

- High speed switching
- Low saturation voltage : $V_{CE(sat)} = 2.1 \text{ V @ } I_C = 20\text{A}$
- High input impedance
- CO-PAK, IGBT with FRD : $t_{rr} = 42\text{ns (typ.)}$

Applications

AC & DC motor controls, general purpose inverters, robotics, and servo controls.

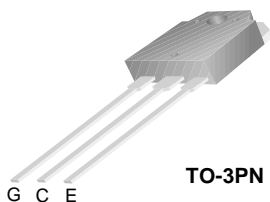

TO-3PN

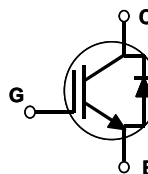

Absolute Maximum Ratings T_C = 25°C unless otherwise noted

Symbol	Description	SGH40N60UFD	Units
V _{CES}	Collector-Emitter Voltage	600	V
V _{GES}	Gate-Emitter Voltage	± 20	V
I _C	Collector Current @ T _C = 25°C	40	A
	Collector Current @ T _C = 100°C	20	A
I _{CM(1)}	Pulsed Collector Current	160	A
I _F	Diode Continuous Forward Current @ T _C = 100°C	15	A
I _{FM}	Diode Maximum Forward Current	160	A
P _D	Maximum Power Dissipation @ T _C = 25°C	160	W
	Maximum Power Dissipation @ T _C = 100°C	64	W
T _J	Operating Junction Temperature	-55 to +150	°C
T _{stg}	Storage Temperature Range	-55 to +150	°C
T _L	Maximum Lead Temp. for Soldering Purposes, 1/8" from Case for 5 Seconds	300	°C

Notes :

(1) Repetitive rating : Pulse width limited by max. junction temperature

Thermal Characteristics

Symbol	Parameter	Typ.	Max.	Units
R _{θJC} (IGBT)	Thermal Resistance, Junction-to-Case	--	0.77	°C/W
R _{θJC} (DIODE)	Thermal Resistance, Junction-to-Case	--	1.7	°C/W
R _{θJA}	Thermal Resistance, Junction-to-Ambient	--	40	°C/W

Electrical Characteristics of the IGBT T_C = 25°C unless otherwise noted

Symbol	Parameter	Test Conditions	Min.	Typ.	Max.	Units
Off Characteristics						
BV _{CES}	Collector-Emitter Breakdown Voltage	V _{GE} = 0V, I _C = 250uA	600	--	--	V
ΔBV _{CES} /ΔT _J	Temperature Coefficient of Breakdown Voltage	V _{GE} = 0V, I _C = 1mA	--	0.6	--	V/°C
I _{CES}	Collector Cut-Off Current	V _{CE} = V _{CES} , V _{GE} = 0V	--	--	250	uA
I _{GES}	G-E Leakage Current	V _{GE} = V _{GES} , V _{CE} = 0V	--	--	± 100	nA

On Characteristics

V _{GE(th)}	G-E Threshold Voltage	I _C = 20mA, V _{CE} = V _{GE}	3.5	4.5	6.5	V
V _{CE(sat)}	Collector to Emitter Saturation Voltage	I _C = 20A, V _{GE} = 15V	--	2.1	2.6	V
		I _C = 40A, V _{GE} = 15V	--	2.6	--	V

Dynamic Characteristics

C _{ies}	Input Capacitance	V _{CE} = 30V, V _{GE} = 0V, f = 1MHz	--	1430	--	pF
C _{oes}	Output Capacitance		--	170	--	pF
C _{res}	Reverse Transfer Capacitance		--	50	--	pF

Switching Characteristics

t _{d(on)}	Turn-On Delay Time	V _{CC} = 300 V, I _C = 20A, R _G = 10Ω, V _{GE} = 15V, Inductive Load, T _C = 25°C	--	15	--	ns
t _r	Rise Time		--	30	--	ns
t _{d(off)}	Turn-Off Delay Time		--	65	130	ns
t _f	Fall Time		--	50	150	ns
E _{on}	Turn-On Switching Loss		--	160	--	uJ
E _{off}	Turn-Off Switching Loss		--	200	--	uJ
E _{ts}	Total Switching Loss	--	360	600	uJ	
t _{d(on)}	Turn-On Delay Time	V _{CC} = 300 V, I _C = 20A, R _G = 10Ω, V _{GE} = 15V, Inductive Load, T _C = 125°C	--	30	--	ns
t _r	Rise Time		--	37	--	ns
t _{d(off)}	Turn-Off Delay Time		--	110	200	ns
t _f	Fall Time		--	144	250	ns
E _{on}	Turn-On Switching Loss		--	310	--	uJ
E _{off}	Turn-Off Switching Loss		--	430	--	uJ
E _{ts}	Total Switching Loss	--	740	1200	uJ	
Q _g	Total Gate Charge	V _{CE} = 300 V, I _C = 20A, V _{GE} = 15V	--	97	150	nC
Q _{ge}	Gate-Emitter Charge		--	20	30	nC
Q _{gc}	Gate-Collector Charge		--	25	40	nC
L _e	Internal Emitter Inductance	Measured 5mm from PKG	--	14	--	nH

Electrical Characteristics of DIODE T_C = 25°C unless otherwise noted

Symbol	Parameter	Test Conditions	Min.	Typ.	Max.	Units	
V _{FM}	Diode Forward Voltage	I _F = 15A	T _C = 25°C	--	1.4	1.7	V
			T _C = 100°C	--	1.3	--	
t _{rr}	Diode Reverse Recovery Time	I _F = 15A, di/dt = 200A/us	T _C = 25°C	--	42	60	ns
			T _C = 100°C	--	74	--	
I _{rr}	Diode Peak Reverse Recovery Current	I _F = 15A, di/dt = 200A/us	T _C = 25°C	--	4.5	6.0	A
			T _C = 100°C	--	6.5	--	
Q _{rr}	Diode Reverse Recovery Charge	I _F = 15A, di/dt = 200A/us	T _C = 25°C	--	80	180	nC
			T _C = 100°C	--	220	--	

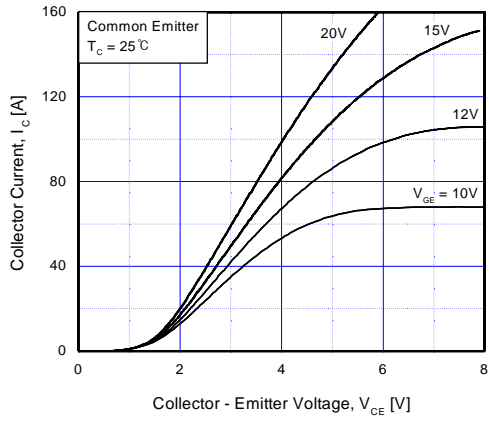

Fig 1. Typical Output Characteristics

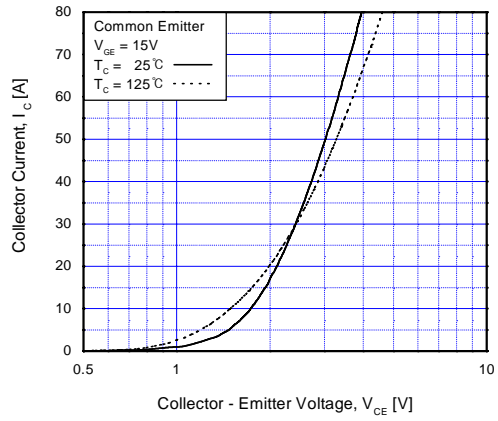

Fig 2. Typical Saturation Voltage Characteristics

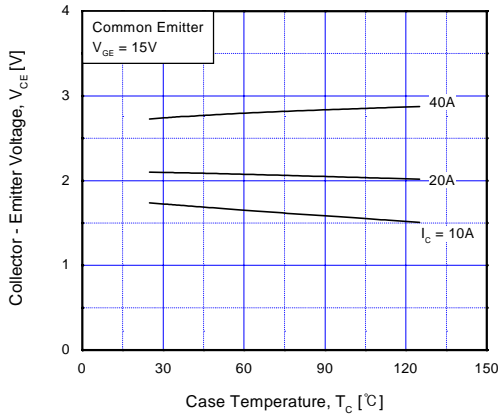

Fig 3. Saturation Voltage vs. Case Temperature at Variant Current Level

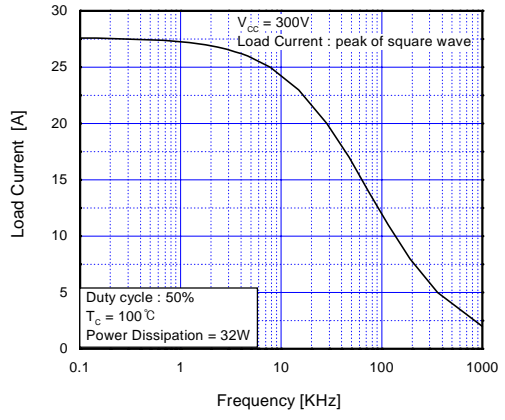

Fig 4. Load Current vs. Frequency

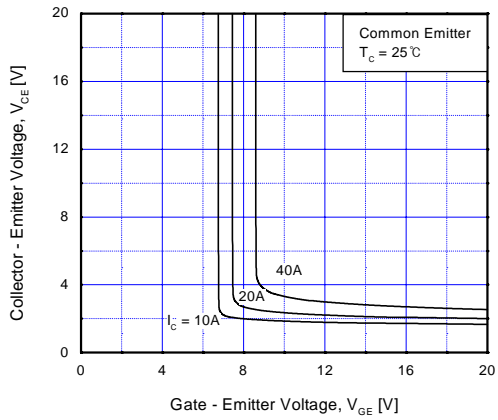

Fig 5. Saturation Voltage vs. V_{GE}

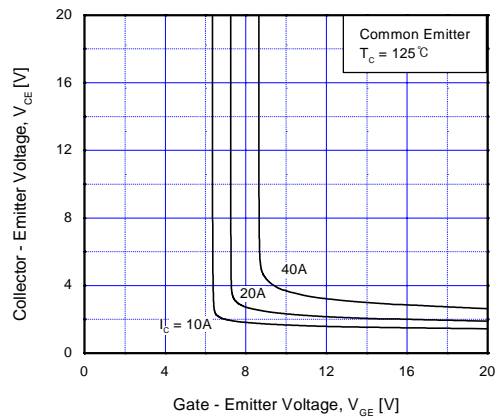

Fig 6. Saturation Voltage vs. V_{GE}

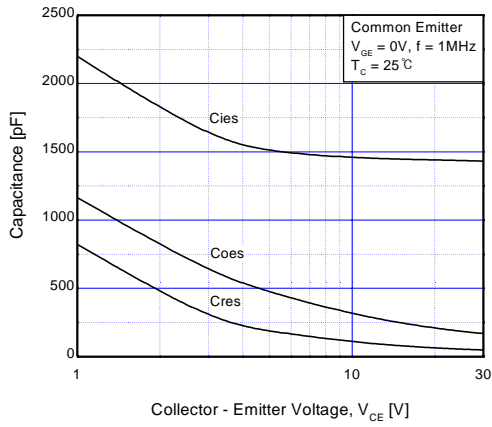

Fig 7. Capacitance Characteristics

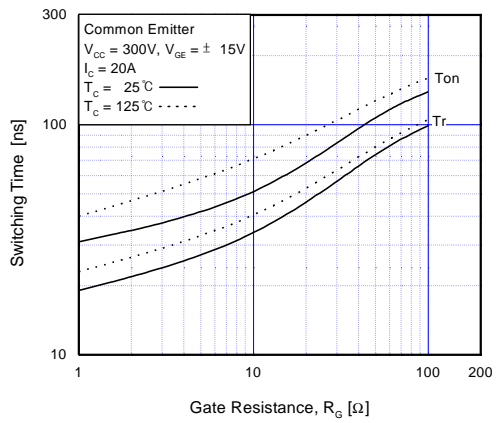

Fig 8. Turn-On Characteristics vs. Gate Resistance

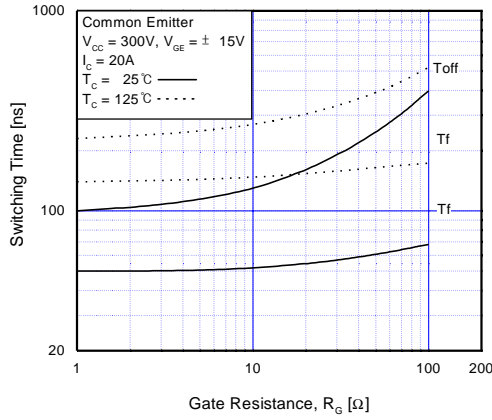

Fig 9. Turn-Off Characteristics vs. Gate Resistance

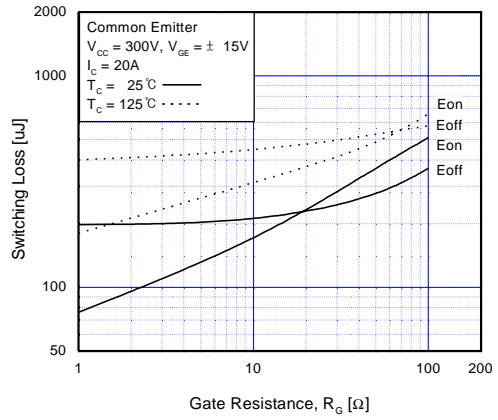

Fig 10. Switching Loss vs. Gate Resistance

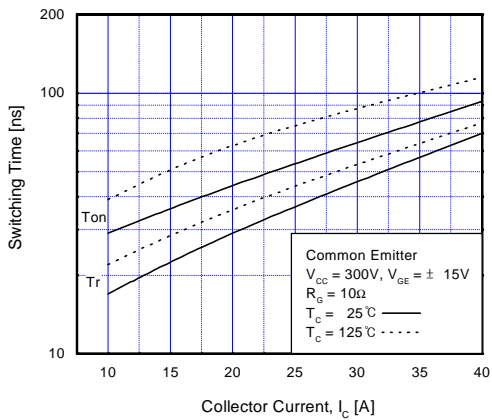

Fig 11. Turn-On Characteristics vs. Collector Current

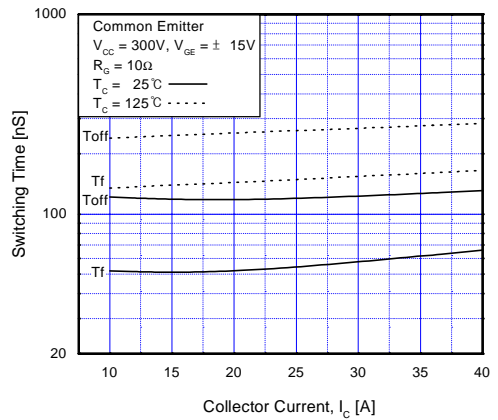

Fig 12. Turn-Off Characteristics vs. Collector Current

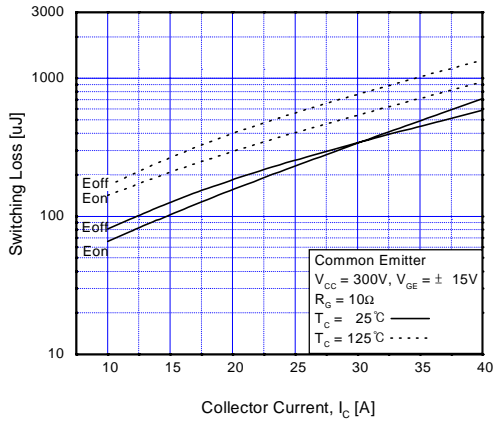

Fig 13. Switching Loss vs. Collector Current

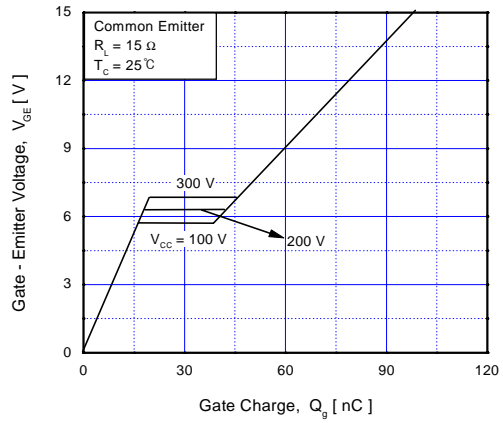

Fig 14. Gate Charge Characteristics

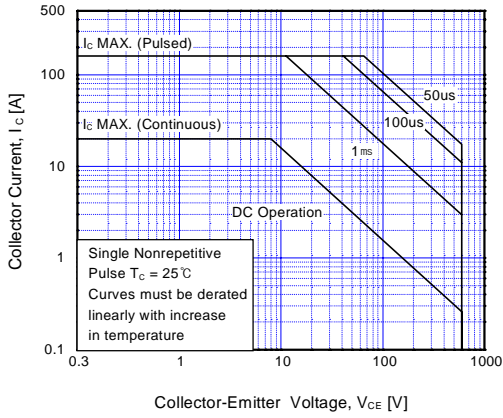

Fig 15. SOA Characteristics

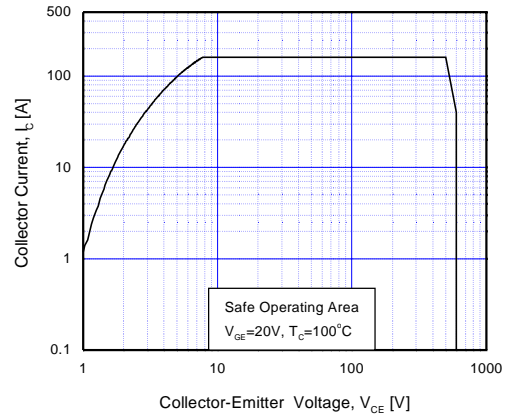

Fig 16. Turn-Off SOA Characteristics

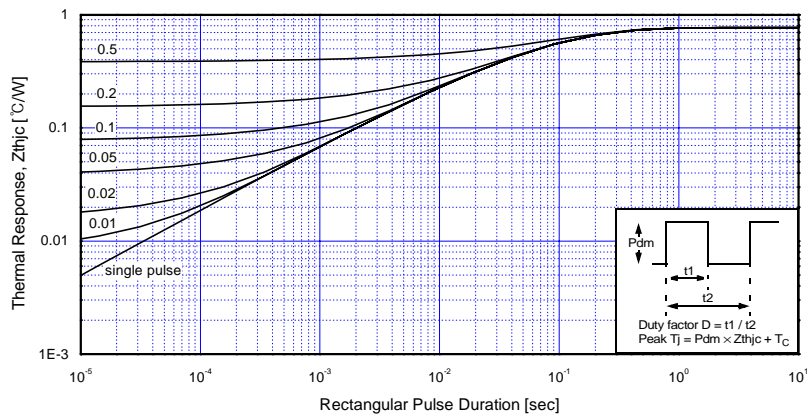

Fig 17. Transient Thermal Impedance of IGBT

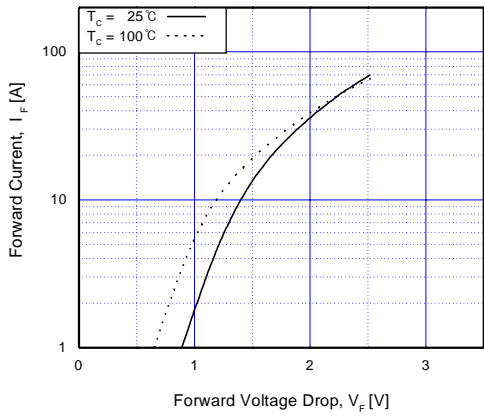

Fig 18. Forward Characteristics

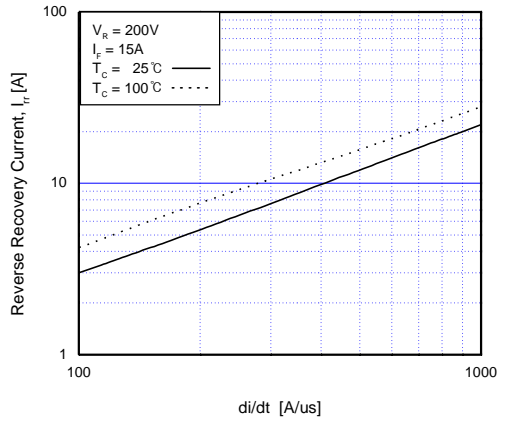

Fig 19. Reverse Recovery Current

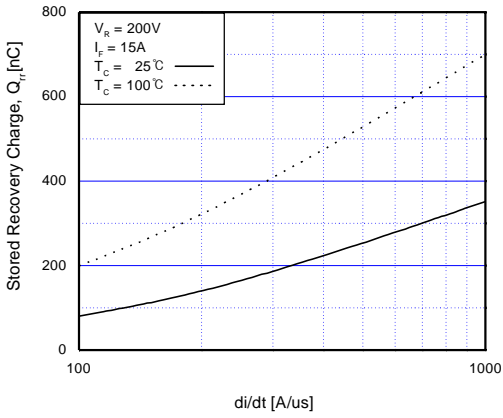

Fig 20. Stored Charge

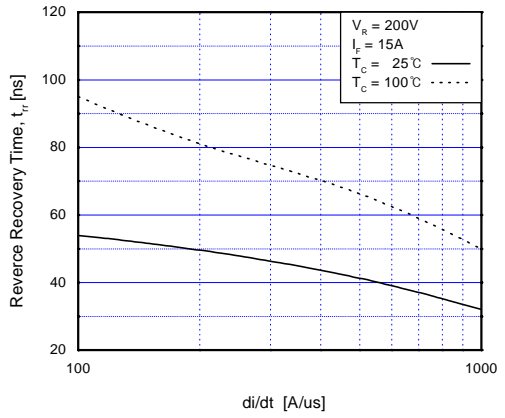
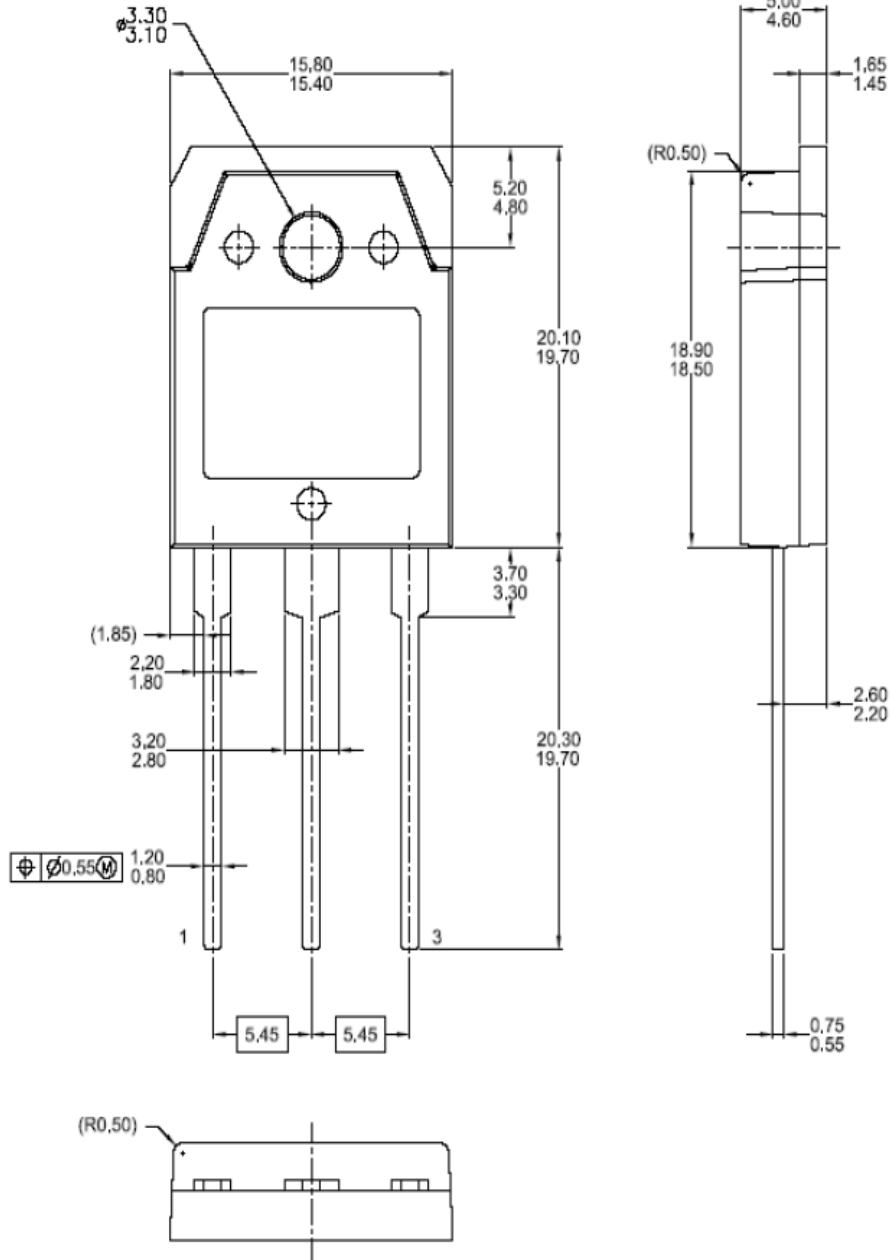

Fig 21. Reverse Recovery Time

Mechanical Dimensions

TO-3PN



Dimensions in Millimeters

TRADEMARKS

The following are registered and unregistered trademarks Fairchild Semiconductor owns or is authorized to use and is not intended to be an exhaustive list of all such trademarks.

ACEx™	FAST®	MICROWIRE™	SLIENT SWITCHER®	UHC™
Bottomless™	FASTr™	OPTOLOGIC™	SMART START™	UltraFET®
CoolFET™	FRFET™	OPTOPLANAR™	SPM™	VCX™
CROSSVOLT™	GlobalOptoisolator™	PACMAN™	STAR*POWER™	
DenseTrench™	GTO™	POPT™	Stealth™	
DOMETM	HiSeC™	Power247™	SuperSOT™-3	
EcoSPARK™	I ² C™	PowerTrench®	SuperSOT™-6	
E ² CMOS™	ISOPLANAR™	QFET™	SuperSOT™-8	
EnSigna™	LittleFET™	QST™	SyncFET™	
FACT™	MicroFET™	QT Optoelectronics™	TinyLogic™	
FACT Quiet Series™	MicroPak™	Quiet Series™	TruTranslation™	

STAR*POWER is used under license

DISCLAIMER

FAIRCHILD SEMICONDUCTOR RESERVES THE RIGHT TO MAKE CHANGES WITHOUT FURTHER NOTICE TO ANY PRODUCTS HEREIN TO IMPROVE RELIABILITY, FUNCTION OR DESIGN. FAIRCHILD DOES NOT ASSUME ANY LIABILITY ARISING OUT OF THE APPLICATION OR USE OF ANY PRODUCT OR CIRCUIT DESCRIBED HEREIN; NEITHER DOES IT CONVEY ANY LICENSE UNDER ITS PATENT RIGHTS, NOR THE RIGHTS OF OTHERS.

LIFE SUPPORT POLICY

FAIRCHILD'S PRODUCTS ARE NOT AUTHORIZED FOR USE AS CRITICAL COMPONENTS IN LIFE SUPPORT DEVICES OR SYSTEMS WITHOUT THE EXPRESS WRITTEN APPROVAL OF FAIRCHILD SEMICONDUCTOR CORPORATION.

As used herein:

1. Life support devices or systems are devices or systems which, (a) are intended for surgical implant into the body, or (b) support or sustain life, or (c) whose failure to perform when properly used in accordance with instructions for use provided in the labeling, can be reasonably expected to result in significant injury to the user.
2. A critical component is any component of a life support device or system whose failure to perform can be reasonably expected to cause the failure of the life support device or system, or to affect its safety or effectiveness.

PRODUCT STATUS DEFINITIONS

Definition of Terms

Datasheet Identification	Product Status	Definition
Advance Information	Formative or In Design	This datasheet contains the design specifications for product development. Specifications may change in any manner without notice.
Preliminary	First Production	This datasheet contains preliminary data, and supplementary data will be published at a later date. Fairchild Semiconductor reserves the right to make changes at any time without notice in order to improve design.
No Identification Needed	Full Production	This datasheet contains final specifications. Fairchild Semiconductor reserves the right to make changes at any time without notice in order to improve design.
Obsolete	Not In Production	This datasheet contains specifications on a product that has been discontinued by Fairchild semiconductor. The datasheet is printed for reference information only.