

## Silicon carbide Power MOSFET 1200 V, 65 A, 59 mΩ (typ., T<sub>J</sub>=150 °C) in an HiP247™ package

Datasheet - production data

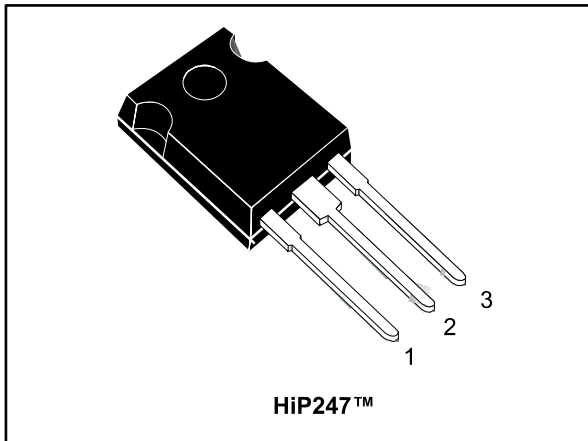

Figure 1: Internal schematic diagram

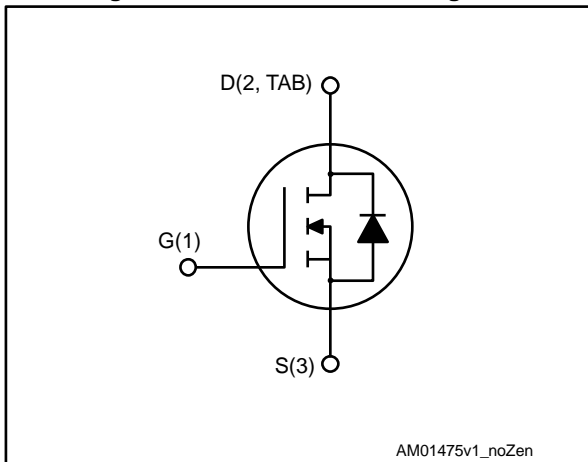

Table 1: Device summary

Order code	Marking	Package	Packaging
SCT50N120	SCT50N120	HiP247™	Tube

### Features

- Very tight variation of on-resistance vs. temperature
- Very high operating junction temperature capability (T<sub>J</sub> = 200 °C)
- Very fast and robust intrinsic body diode
- Low capacitance

### Applications

- Solar inverters, UPS
- Motor drives
- High voltage DC-DC converters
- Switch mode power supplies

### Description

This silicon carbide Power MOSFET is produced exploiting the advanced, innovative properties of wide bandgap materials. This results in unsurpassed on-resistance per unit area and very good switching performance almost independent of temperature. The outstanding thermal properties of the SiC material allows designers to use an industry-standard outline with significantly improved thermal capability. These features render the device perfectly suitable for high-efficiency and high power density applications.

---

## Contents

<b>1</b>	<b>Electrical ratings .....</b>	<b>3</b>
<b>2</b>	<b>Electrical characteristics .....</b>	<b>4</b>
	2.1 Electrical characteristics (curves).....	5
<b>3</b>	<b>Package information .....</b>	<b>8</b>
	3.1 HiP247™ package information.....	8
<b>4</b>	<b>Revision history .....</b>	<b>10</b>

# 1 Electrical ratings

**Table 2: Absolute maximum ratings**

Symbol	Parameter	Value	Unit
$V_{DS}$	Drain-source voltage	1200	V
$V_{GS}$	Gate-source voltage	-10 to 25	V
$I_D$	Drain current (continuous) at $T_C = 25\text{ °C}$	65	A
$I_D$	Drain current (continuous) at $T_C = 100\text{ °C}$	50	A
$I_{DM}^{(1)}$	Drain current (pulsed)	130	A
$P_{TOT}$	Total dissipation at $T_C = 25\text{ °C}$	318	W
$T_{stg}$	Storage temperature range	-55 to 200	°C
$T_j$	Operating junction temperature range		°C

**Notes:**

<sup>(1)</sup>Pulse width limited by safe operating area.

**Table 3: Thermal data**

Symbol	Parameter	Value	Unit
$R_{thj-case}$	Thermal resistance junction-case	0.55	°C/W
$R_{thj-amb}$	Thermal resistance junction-ambient	40	°C/W

## 2 Electrical characteristics

( $T_{CASE} = 25\text{ °C}$  unless otherwise specified).

**Table 4: On/off states**

Symbol	Parameter	Test conditions	Min.	Typ.	Max.	Unit
$I_{DSS}$	Zero gate voltage drain current	$V_{DS} = 1200\text{ V}, V_{GS} = 0\text{ V}$		1	100	$\mu\text{A}$
		$V_{DS} = 1200\text{ V}, V_{GS} = 0\text{ V}, T_J = 200\text{ °C}$		10		$\mu\text{A}$
$I_{GSS}$	Gate-body leakage current	$V_{DS} = 0\text{ V}, V_{GS} = -10\text{ to }22\text{ V}$			$\pm 100$	nA
$V_{GS(th)}$	Gate threshold voltage	$V_{DS} = V_{GS}, I_D = 1\text{ mA}$	1.8	3.0		V
$R_{DS(on)}$	Static drain-source on-resistance	$V_{GS} = 20\text{ V}, I_D = 40\text{ A}$		52	69	m $\Omega$
		$V_{GS} = 20\text{ V}, I_D = 40\text{ A}, T_J = 150\text{ °C}$		59		m $\Omega$
		$V_{GS} = 20\text{ V}, I_D = 40\text{ A}, T_J = 200\text{ °C}$		70		m $\Omega$

**Table 5: Dynamic**

Symbol	Parameter	Test conditions	Min.	Typ.	Max.	Unit
$C_{iss}$	Input capacitance	$V_{DS} = 400\text{ V}, f = 1\text{ MHz}, V_{GS} = 0\text{ V}$	-	1900	-	pF
$C_{oss}$	Output capacitance		-	170	-	pF
$C_{riss}$	Reverse transfer capacitance		-	30	-	pF
$Q_g$	Total gate charge	$V_{DD} = 800\text{ V}, I_D = 40\text{ A}, V_{GS} = 0\text{ to }20\text{ V}$	-	122	-	nC
$Q_{gs}$	Gate-source charge		-	19	-	nC
$Q_{gd}$	Gate-drain charge		-	35	-	nC
$R_g$	Gate input resistance	$f=1\text{ MHz}$ open drain	-	1.9	-	$\Omega$

**Table 6: Switching energy (inductive load)**

Symbol	Parameter	Test conditions	Min.	Typ.	Max.	Unit
$E_{on}$	Turn-on switching energy	$V_{DD} = 800\text{ V}, I_D = 40\text{ A}$	-	530	-	$\mu\text{J}$
$E_{off}$	Turn-off switching energy	$R_G = 2.2\ \Omega, V_{GS} = -5\text{ to }20\text{ V}$	-	310	-	$\mu\text{J}$
$E_{on}$	Turn-on switching energy	$V_{DD} = 800\text{ V}, I_D = 40\text{ A}$	-	670	-	$\mu\text{J}$
$E_{off}$	Turn-off switching energy	$R_G = 2.2\ \Omega, V_{GS} = -5\text{ to }20\text{ V}, T_J = 150\text{ °C}$	-	334	-	$\mu\text{J}$

**Table 7: Reverse SiC diode characteristics**

Symbol	Parameter	Test conditions	Min	Typ.	Max	Unit
$V_{SD}$	Diode forward voltage	$I_F = 20\text{ A}, V_{GS} = 0\text{ V}$	-	3.5	-	V
$t_{rr}$	Reverse recovery time	$I_F = 40\text{ A}, di/dt = 2000/\text{ns}, V_{DD} = 800\text{ V}$	-	55		ns
$Q_{rr}$	Reverse recovery charge		-	230	-	nC
$I_{RRM}$	Reverse recovery current		-	14	-	A

## 2.1 Electrical characteristics (curves)

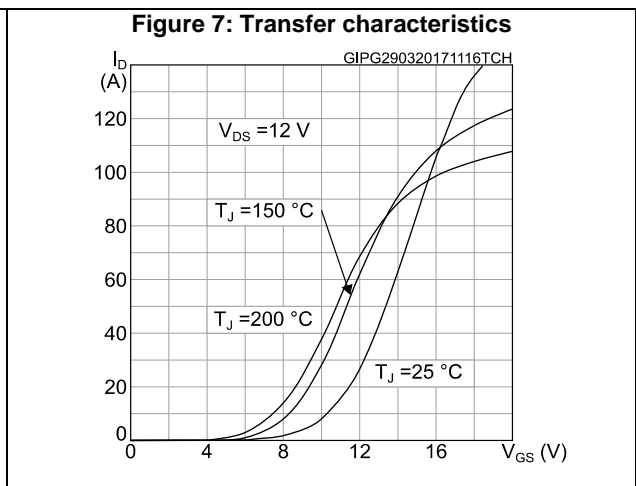
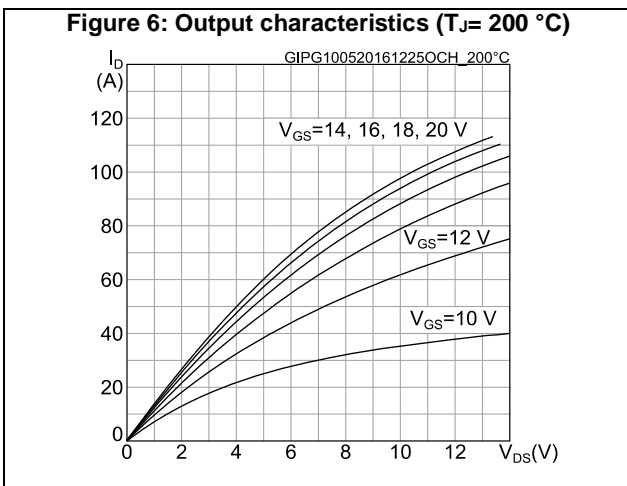
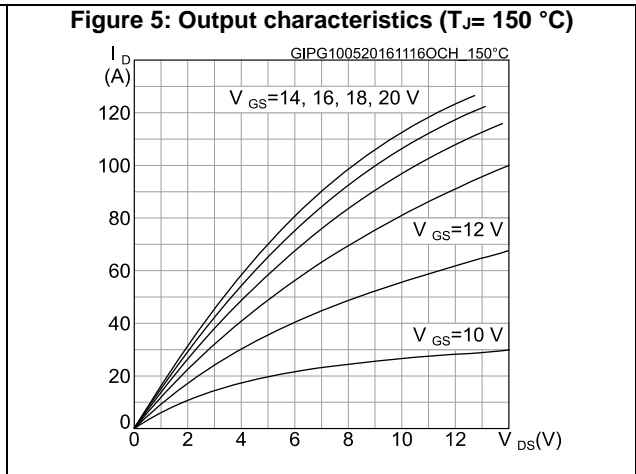
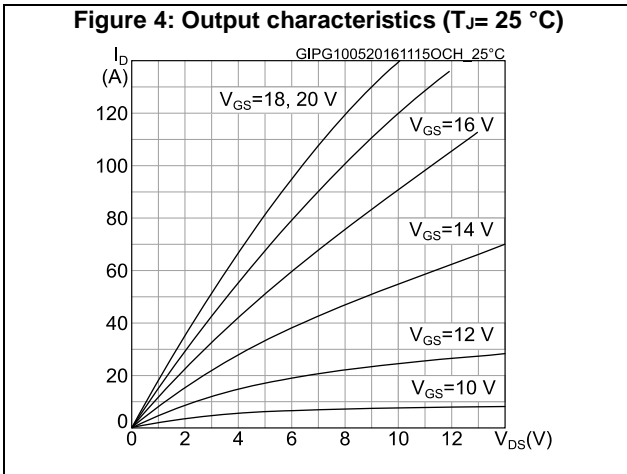
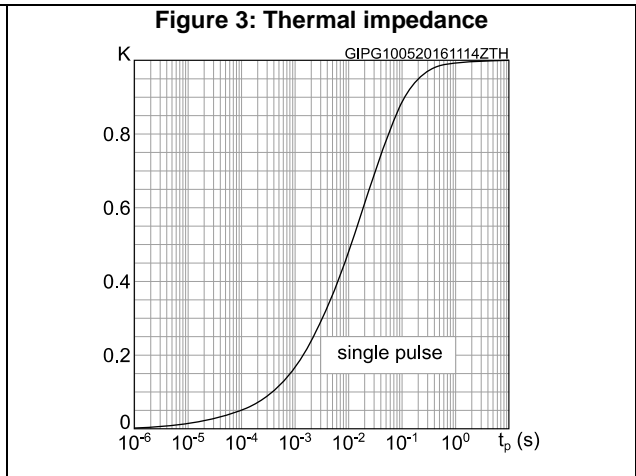
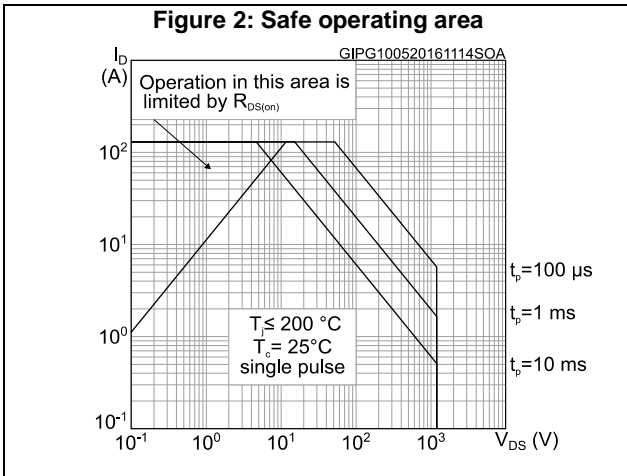

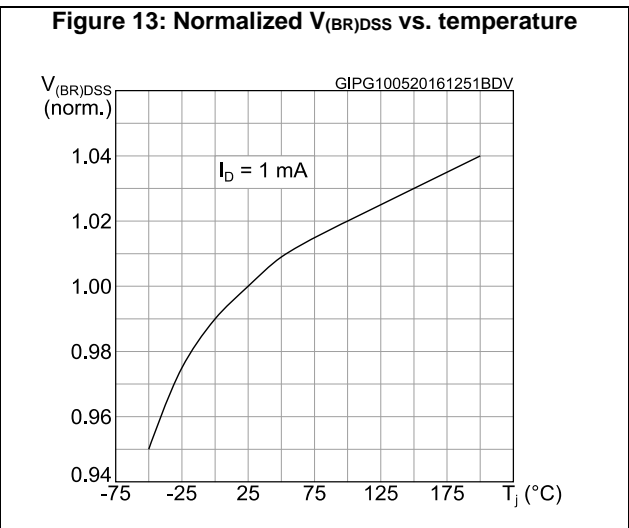
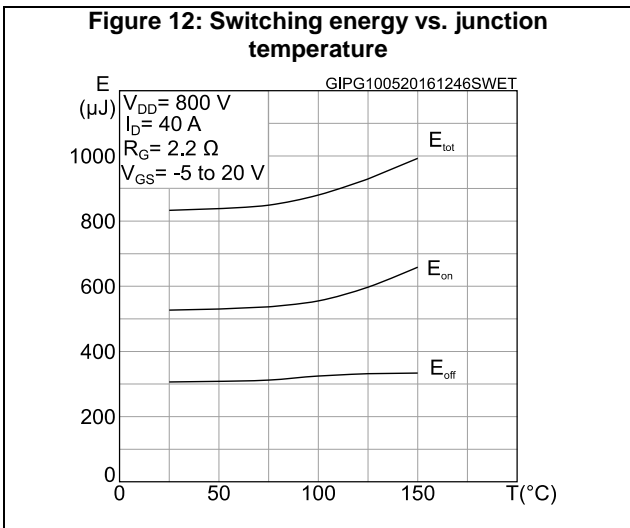
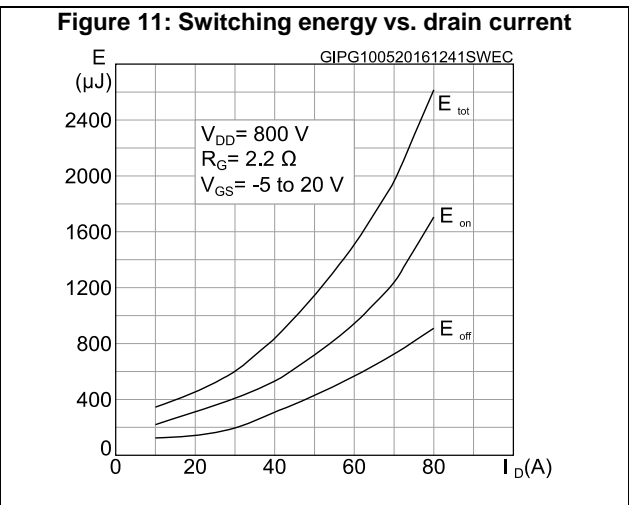
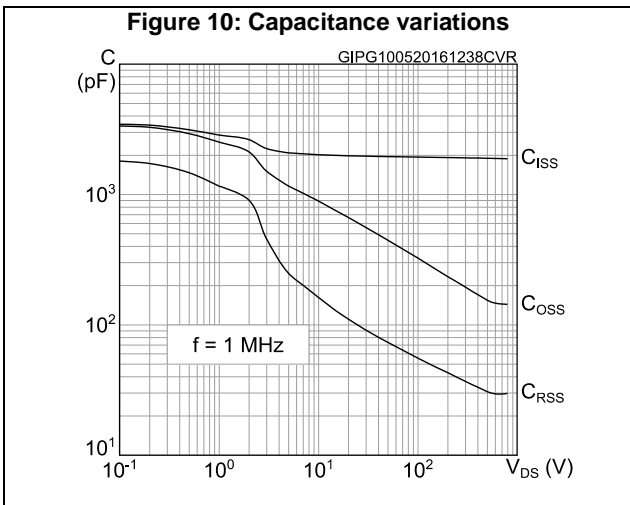
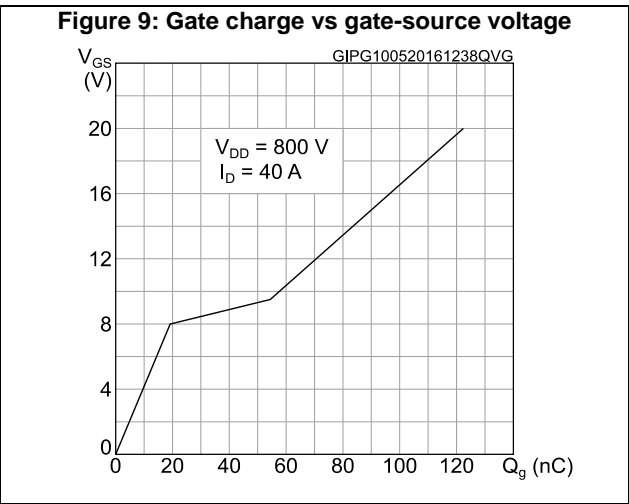
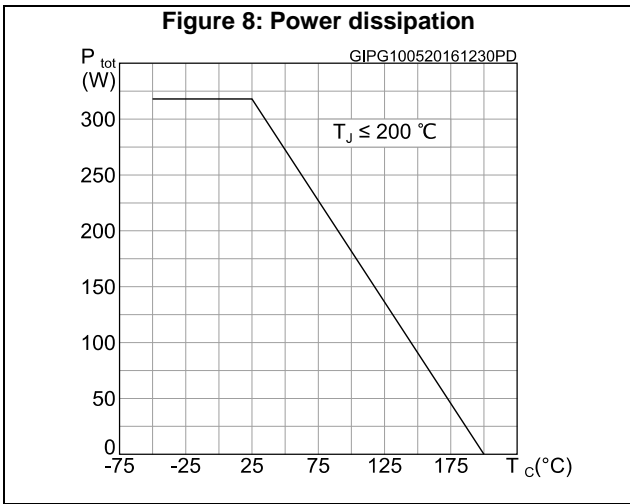

Figure 14: Normalized gate threshold voltage vs. temperature

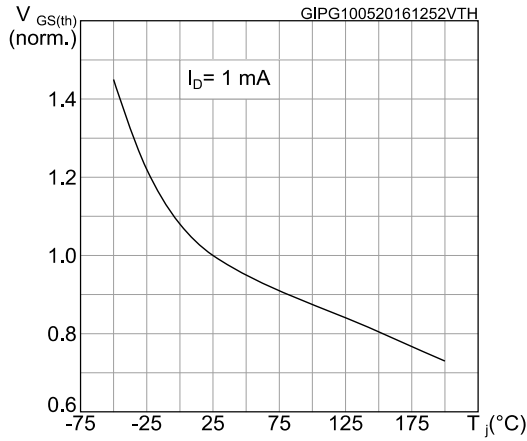

Figure 15: Normalized on-resistance vs. temperature

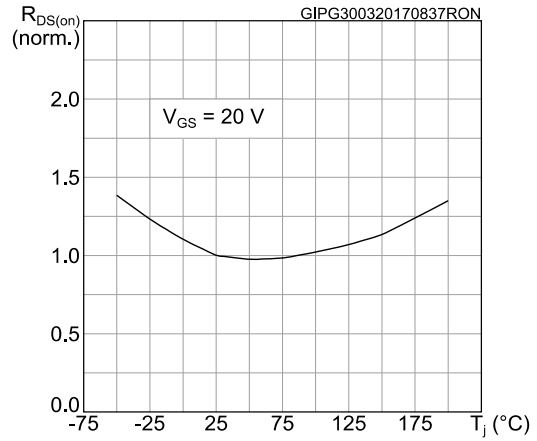

Figure 16: Reverse conduction characteristics ( $T_J = -50 \text{ °C}$ )

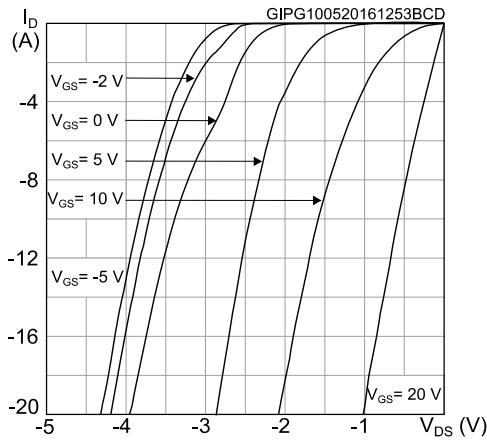

Figure 17: Reverse conduction characteristics ( $T_J = 25 \text{ °C}$ )

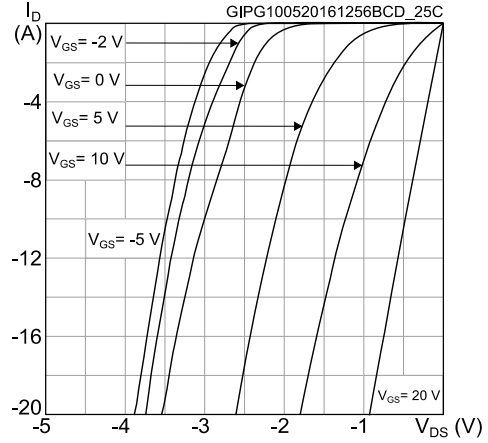
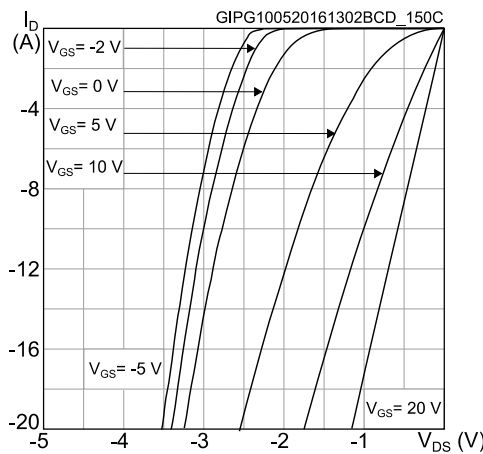

Figure 18: Reverse conduction characteristics ( $T_J = 150 \text{ °C}$ )



### 3 Package information

In order to meet environmental requirements, ST offers these devices in different grades of ECOPACK® packages, depending on their level of environmental compliance. ECOPACK® specifications, grade definitions and product status are available at: [www.st.com](http://www.st.com). ECOPACK® is an ST trademark.

#### 3.1 HiP247™ package information

Figure 19: HiP247™ package outline

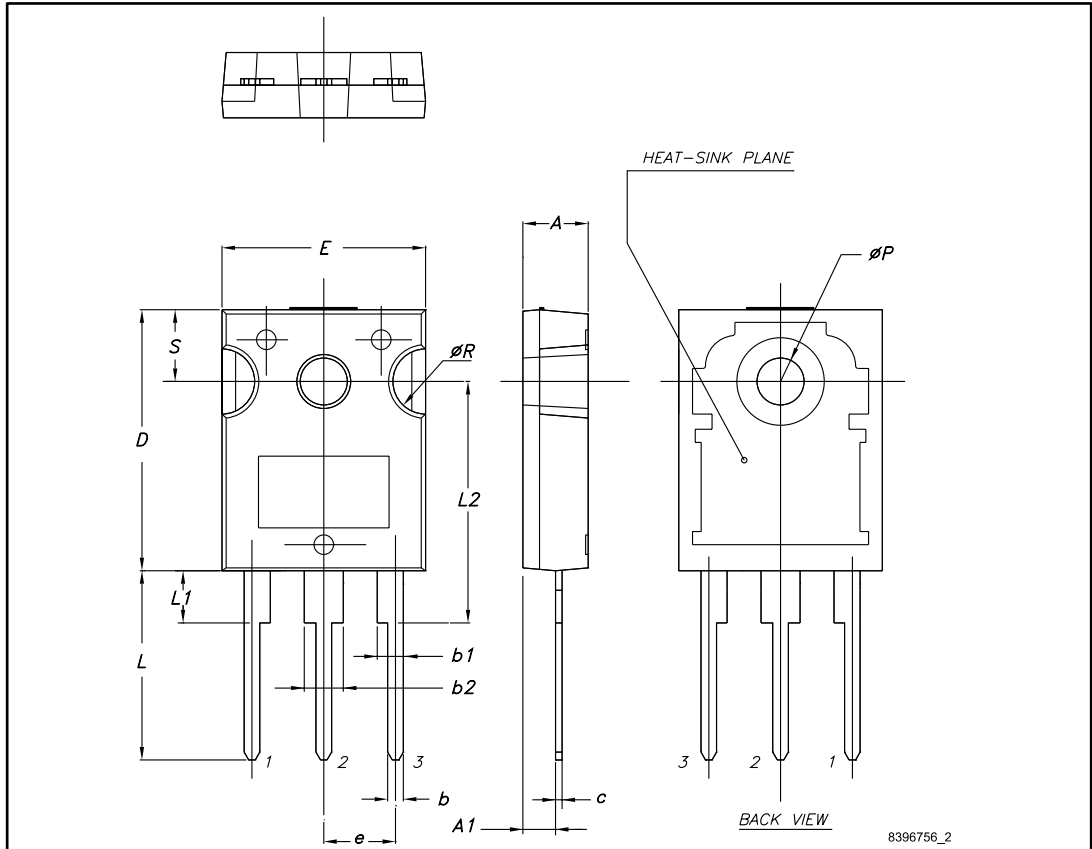



Table 8: HiP247™ package mechanical data

Dim.	mm		
	Min.	Typ.	Max.
A	4.85		5.15
A1	2.20		2.60
b	1.0		1.40
b1	2.0		2.40
b2	3.0		3.40
c	0.40		0.80
D	19.85		20.15
E	15.45		15.75
e	5.30	5.45	5.60
L	14.20		14.80
L1	3.70		4.30
L2		18.50	
ØP	3.55		3.65
ØR	4.50		5.50
S	5.30	5.50	5.70

## 4 Revision history

**Table 9: Document revision history**

Date	Revision	Changes
17-Jun-2015	1	First release
12-May-2016	2	Modified title. Modified: Table 2: "Absolute maximum ratings", Table 4: "On/off states", Table 5: "Dynamic", Table 6: "Switching energy (inductive load)", and Table 7: "Reverse SiC diode characteristics". Added: Section 4.1: "Electrical characteristics (curves)". Minor text changes.
23-Jun-2016	3	Document status promoted from preliminary to production data.
03-Apr-2017	4	Modified <i>Table 7: "Reverse SiC diode characteristics"</i> Modified <i>Figure 7: "Transfer characteristics"</i> , <i>Figure 15: "Normalized on-resistance vs. temperature"</i> , <i>Figure 16: "Reverse conduction characteristics (T<sub>J</sub> = -50 °C)"</i> , <i>Figure 17: "Reverse conduction characteristics (T<sub>J</sub> = 25 °C)"</i> and <i>Figure 18: "Reverse conduction characteristics (T<sub>J</sub> = 150 °C)"</i> Updated <i>Section 3: "Package information"</i> Minor text changes.

**IMPORTANT NOTICE – PLEASE READ CAREFULLY**

STMicroelectronics NV and its subsidiaries ("ST") reserve the right to make changes, corrections, enhancements, modifications, and improvements to ST products and/or to this document at any time without notice. Purchasers should obtain the latest relevant information on ST products before placing orders. ST products are sold pursuant to ST's terms and conditions of sale in place at the time of order acknowledgement.

Purchasers are solely responsible for the choice, selection, and use of ST products and ST assumes no liability for application assistance or the design of Purchasers' products.

No license, express or implied, to any intellectual property right is granted by ST herein.

Resale of ST products with provisions different from the information set forth herein shall void any warranty granted by ST for such product.

ST and the ST logo are trademarks of ST. All other product or service names are the property of their respective owners.

Information in this document supersedes and replaces information previously supplied in any prior versions of this document.

© 2017 STMicroelectronics – All rights reserved