

## 10-A, 4.75-V to 14-V INPUT, NON-ISOLATED, WIDE-OUTPUT, DIGITAL POWERTRAIN™ MODULE

Check for Samples: [PTD08A010W](#)

### FEATURES

- Up to 10-A Output Current
- 4.75-V to 14-V Input Voltage
- Programmable Wide-Output Voltage (0.7 V to 3.6 V)
- Efficiencies up to 96%
- Digital I/O
  - PWM signal
  - INHIBIT
  - Current limit flag (FAULT)
  - Synchronous Rectifier Enable (SRE)
- Analog I/O
  - Temperature
  - Output current
- Safety Agency Approvals: (Pending)
  - UL/IEC/CSA-C22.2 60950-1
- Operating Temperature: –40°C to 85°C

### APPLICATIONS

- Digital Power Systems using UCD9XXX Digital Controllers

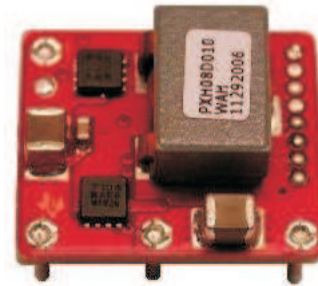

### DESCRIPTION

The PTD08A010W is a high-performance 10-A rated, non-isolated digital PowerTrain module. This module is the power conversion section of a digital power system which incorporates TI's UCD7230 MOSFET driver IC. The PTD08A010W must be used in conjunction with a digital power controller such as the UCD9240 or UCD9110 family. The PTD08A010W receives control signals from the digital controller and provides parametric and status information back to the digital controller. Together, PowerTrain modules and a digital power controller form a sophisticated, robust, and easily configured power management solution.

Operating from an input voltage range of 4.75 V to 14 V, the PTD08A010W provides step-down power conversion to a wide range of output voltages from, 0.7 V to 3.6 V. The wide input voltage range makes the PTD08A010W particularly suitable for advanced computing and server applications that utilize a loosely regulated 8-V, 9.6-V or 12-V intermediate distribution bus. Additionally, the wide input voltage range increases design flexibility by supporting operation with tightly regulated 5-V or 12-V intermediate bus architectures.

The module incorporates output over-current and temperature monitoring which protects against most load faults. Output current and module temperature signals are provided for the digital controller to permit user defined over-current and over-temperature warning and fault scenarios.

The module uses double-sided surface mount construction to provide a low profile and compact footprint. Package options include both through-hole and surface mount configurations that are lead (Pb) - free and RoHS compatible.



Please be aware that an important notice concerning availability, standard warranty, and use in critical applications of Texas Instruments semiconductor products and disclaimers thereto appears at the end of this data sheet.

POWERTRAIN is a trademark of Texas Instruments.



This integrated circuit can be damaged by ESD. Texas Instruments recommends that all integrated circuits be handled with appropriate precautions. Failure to observe proper handling and installation procedures can cause damage.

ESD damage can range from subtle performance degradation to complete device failure. Precision integrated circuits may be more susceptible to damage because very small parametric changes could cause the device not to meet its published specifications.

### Standard PTD08A010W Application

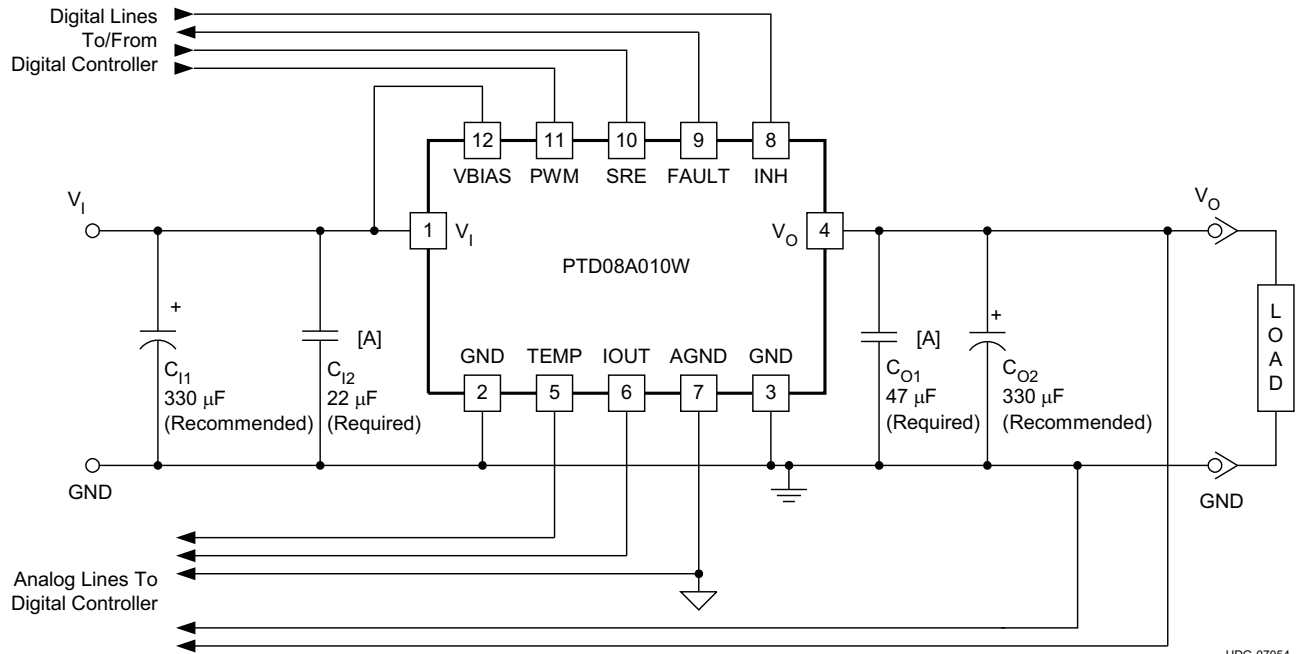

UDG-07054

A. C<sub>12</sub> and C<sub>O1</sub> are optional when the operating frequency is greater than 500 kHz.

### ORDERING INFORMATION

For the most current package and ordering information, see the Package Option Addendum at the end of this datasheet, or see the TI website at [www.ti.com](http://www.ti.com).

### DATASHEET TABLE OF CONTENTS

DATASHEET SECTION	PAGE NUMBER
ENVIRONMENTAL AND ABSOLUTE MAXIMUM RATINGS	3
ELECTRICAL CHARACTERISTICS TABLE	4
TERMINAL FUNCTIONS	5
TYPICAL CHARACTERISTICS ( $V_I = 12V$ )	6
TYPICAL CHARACTERISTICS ( $V_I = 5V$ )	8
TYPICAL APPLICATION SCHEMATIC	10
GRAPHICAL USER INTERFACE VALUES	11
TRAY DRAWINGS	12

### ENVIRONMENTAL AND ABSOLUTE MAXIMUM RATINGS

(Voltages are with respect to GND)

				UNIT
$V_I$	Input voltage		16	V
$V_B$	Bias voltage		16	V
$T_A$	Operating temperature range	Over $V_I$ range	-40 to 85	°C
$T_{wave}$	Wave soldering temperature	Surface temperature of module body or pins for 5 seconds maximum suffix AD	260	
$T_{stg}$	Storage temperature		-55 to 125 <sup>(1)</sup>	G
	Mechanical shock	Per Mil-STD-883D, Method 2002.3, 1 msec, 1/2 sine, mounted suffix AD	200	
	Mechanical vibration	Mil-STD-883D, Method 2007.2, 20-2000 Hz	15	
	Weight		3.9	grams
MTBF	Reliability	Per Telcordia SR-332, 50% stress, $T_A = 40^\circ\text{C}$ , ground benign	9.4	$10^6$ Hr
	Flammability	Meets UL94V-O		

(1) The shipping tray or tape and reel cannot be used to bake parts at temperatures higher than 65°C.

## ELECTRICAL CHARACTERISTICS

### PTD08A010W

$T_A = 25^\circ\text{C}$ ,  $F_{\text{SW}} = 350\text{kHz}$ ,  $V_I = 12\text{ V}$ ,  $V_O = 3.3\text{ V}$ ,  $V_B = V_I$ ,  $C_{I1} = 330\ \mu\text{F}$ ,  $C_{I2} = 22\ \mu\text{F}$  ceramic,  $C_{O1} = 47\ \mu\text{F}$  ceramic,  $C_{O2} = 330\ \mu\text{F}$ , and  $I_O = I_{O(\text{max})}$  (unless otherwise stated)

PARAMETER		TEST CONDITIONS		PTD08A010W			UNIT	
				MIN	TYP	MAX		
$I_O$	Output current	Over $V_O$ range	25°C, natural convection		0	10	A	
$V_I$	Input voltage range	Over $I_O$ range		4.75	14 <sup>(1)</sup>		V	
$V_{\text{OAdj}}$	Output voltage adjust range	Over $I_O$ range		0.7 <sup>(1)</sup>	3.6		V	
$\eta$	Efficiency	$V_I = V_B = 5\text{ V}$ $I_O = 10\text{ A}$ , $f_s = 350\text{ kHz}$	$V_O = 3.3\text{ V}$	95%				
			$V_O = 2.5\text{ V}$	92%				
			$V_O = 1.8\text{ V}$	89%				
			$V_O = 1.5\text{ V}$	88%				
			$V_O = 1.2\text{ V}$	86%				
			$V_O = 1.0\text{ V}$	84%				
$V_{\text{OPP}}$	$V_O$ Ripple (peak-to-peak)	20-MHz bandwidth		20		mV <sub>PP</sub>		
$V_B$	Bias voltage			4.75	14		V	
$V_B$ UVLO	Bias voltage under voltage lockout	$V_B$ increasing		4.25	4.5	4.75	V	
		$V_B$ decreasing		4.0	4.25	4.5		
$I_B$	Bias current	Inhibit (pin 8) to AGND		Standby		4	mA	
				Switching		34		
$V_{\text{IH}}$	High-level input voltage	SRE, INH, & PWM input levels		2.0	5.5		V	
$V_{\text{IL}}$	Low-level input voltage			0.8				
	PWM input	Frequency range		300	1000		kHz	
		Pulse width limits		130				ns
	TEMP output	Range		-40	125		°C	
		Accuracy, $-40^\circ\text{C} \leq T_A \leq 85^\circ\text{C}$		-4	6		°C	
		Slope		10				mV/°C
		Offset, $T_A = 0^\circ\text{C}$		500				mV
$V_{\text{OH}}$	FAULT output	High-level output voltage, $I_{\text{FAULT}} = 4\text{ mA}$		2.7	3.3		V	
$V_{\text{OL}}$		Low-level output voltage, $I_{\text{FAULT}} = 4\text{ mA}$		0	0.6			
$I_{\text{LIM}}$		Overcurrent threshold; Reset, followed by auto-recovery		20		A		
	IOUT output	Range		0.15	3.5		V	
		Gain		70	100	130		mV/A
		Offset, $I_O = 0\text{ A}$ , $V_O = 1.2\text{ V}$		0.44	0.6	0.76		V
		Output Impedance		10	15	21		kΩ
$C_I$	External input capacitance	Nonceramic		330 <sup>(2)</sup>			μF	
		Ceramic		22 <sup>(2)</sup>				
$C_O$	External output capacitance	Capacitance Value		Nonceramic		330 <sup>(3)</sup>	5000 <sup>(4)</sup>	μF
				Ceramic		47 <sup>(3)</sup>	(3)	
		Equivalent series resistance (non-ceramic)		1 <sup>(5)</sup>				mΩ

- (1) The maximum input voltage is duty cycle limited to  $(V_O / (130\text{ns} \times F_{\text{SW}}))$  or 14 V, whichever is less. The maximum allowable input voltage is a function of switching frequency.
- (2) A 22 μF ceramic input capacitor is required for proper operation. An additional 330 μF bulk capacitor rated for a minimum of 500mA rms of ripple current is recommended. When operating at frequencies > 500kHz the 22 μF ceramic capacitor is only recommended. Refer to the UCD9240 controller datasheet and user interface for application specific capacitor specifications.
- (3) A 47 μF ceramic output capacitor is required for basic operation. An additional 330 μF bulk capacitor is recommended for improved transient response. When operating at frequencies > 500kHz the 47 μF ceramic capacitor is only recommended. Refer to the UCD9240 controller datasheet and user interface for application specific capacitor specifications.
- (4) 5,000 μF is the calculated maximum output capacitance given a 1V/msec output voltage rise time. Additional capacitance or increasing the output voltage rise rate may trigger the overcurrent threshold at start-up. Refer to the UCD9240 controller datasheet and user interface for application specific capacitor specifications.
- (5) This is the minimum ESR for all non-ceramic output capacitance. Refer to the UCD9240 controller datasheet and user interface for application specific capacitor specifications.

**TERMINAL FUNCTIONS**

TERMINAL		DESCRIPTION
NAME	NO.	
V <sub>I</sub>	1	The positive input voltage power node to the module, which is referenced to common GND.
GND	2	This is the common ground connection for the V <sub>I</sub> and V <sub>O</sub> power connections.
	3	
V <sub>O</sub>	4	The regulated positive power output with respect to GND.
TEMP	5	Temperature sense output. The voltage level on this pin represents the temperature of the module.
IOUT	6	Current sense output. The voltage level on this pin represents the average output current of the module.
AGND	7	Analog ground return. It is the 0 V <sub>dc</sub> reference for the control inputs.
INH <sup>(1)</sup>	8	The inhibit pin is a negative logic input that is referenced to AGND. Applying a low-level signal to this pin disables the module and turns off the output voltage. A 10 kΩ pull-up to 3.3 V or 5 V is required if the INH signal is not used.
FAULT	9	Current limit flag. The Fault signal is a 3.3 V digital output which is latched high after an over-current condition. The Fault is reset after two complete PWM cycles without an over-current condition (third rising edge of the PWM).
SRE	10	Synchronous Rectifier Enable. This pin is a high impedance digital input. A 3.3 V or 5 V logic level signals is used to enable the synchronous rectifier switch. When this signal is high, the module will source and sink output current. When this signal is low, the module will only source current.
PWM	11	This is the PWM input pin. It is a high impedance digital input that accepts 3.3 V or 5 V logic level signals up to 1 MHz.
VBIAS	12	Bias voltage supply required to power internal circuitry. For optimal performance connect VBIAS to V <sub>I</sub> .

(1) Denotes negative logic: High = Normal operation, Low = Function active

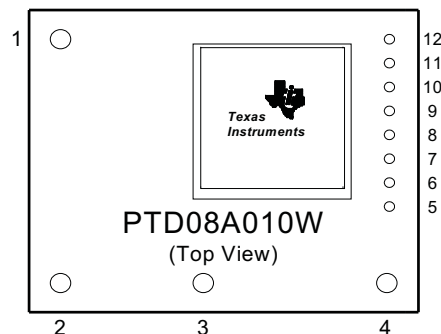

TYPICAL CHARACTERISTICS ( $V_I = 12\text{ V}$ ) <sup>(1)</sup>

EFFICIENCY vs LOAD CURRENT

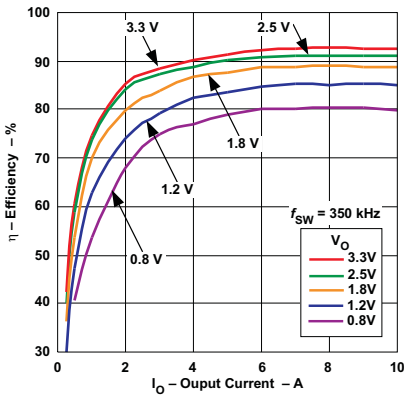

Figure 1.

EFFICIENCY vs LOAD CURRENT

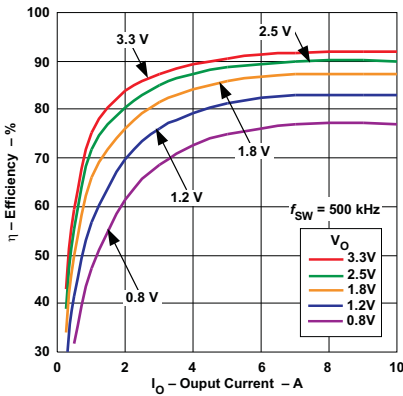

Figure 2.

EFFICIENCY vs LOAD CURRENT

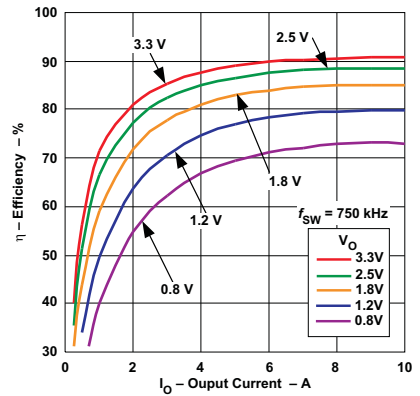

Figure 3.

EFFICIENCY vs LOAD CURRENT

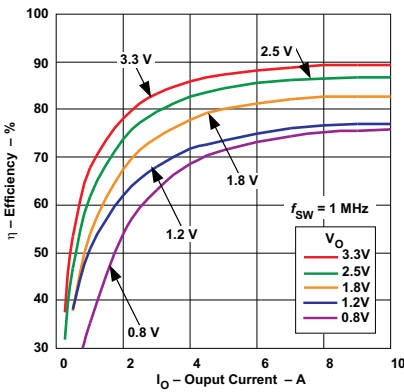

Figure 4.

POWER DISSIPATION vs LOAD CURRENT

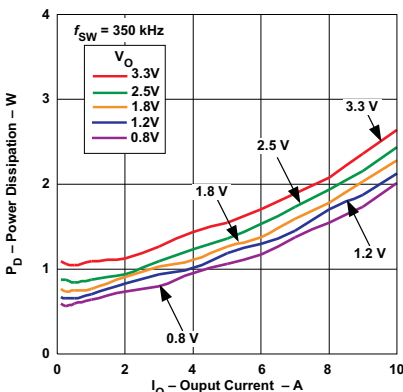

Figure 5.

POWER DISSIPATION vs LOAD CURRENT

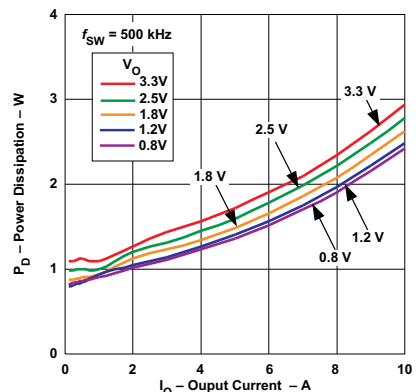

Figure 6.

POWER DISSIPATION vs LOAD CURRENT

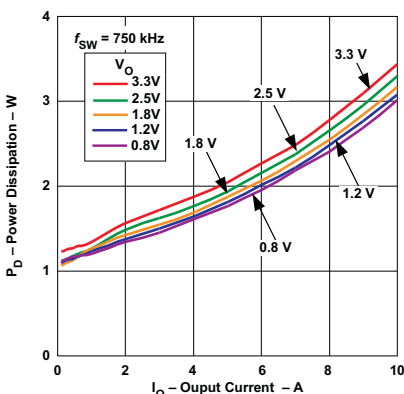

Figure 7.

POWER DISSIPATION vs LOAD CURRENT

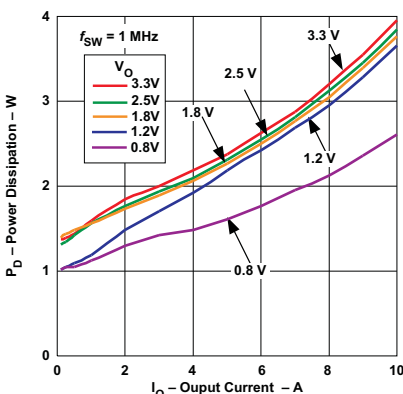

Figure 8.

INPUT BIAS CURRENT vs SWITCHING FREQUENCY

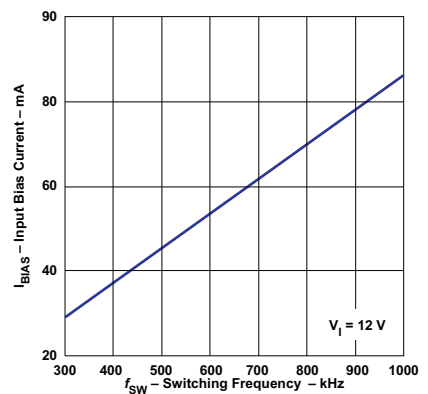

Figure 9.

(1) The electrical characteristic data has been developed from actual products tested at 25°C. This data is considered typical for the converter.

**TYPICAL CHARACTERISTICS ( $V_I = 12\text{ V}$ )**  
**Safe Operating Area <sup>(1)</sup>**

**AMBIENT TEMPERATURE vs LOAD CURRENT**

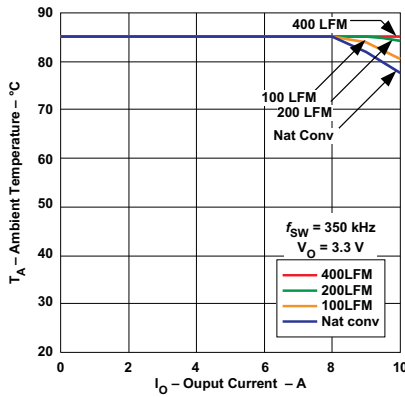

Figure 10.

**AMBIENT TEMPERATURE vs LOAD CURRENT**

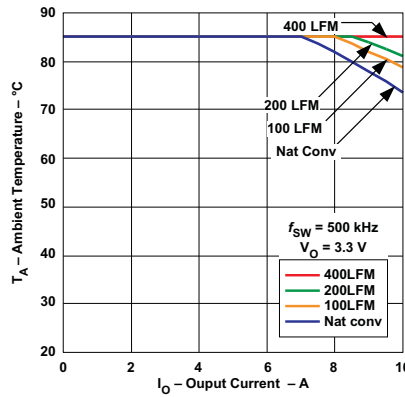

Figure 11.

**AMBIENT TEMPERATURE vs LOAD CURRENT**

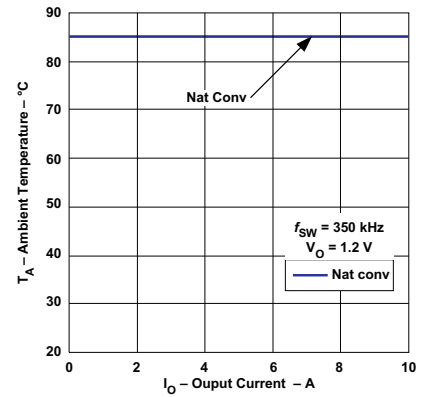

Figure 12.

**AMBIENT TEMPERATURE vs LOAD CURRENT**

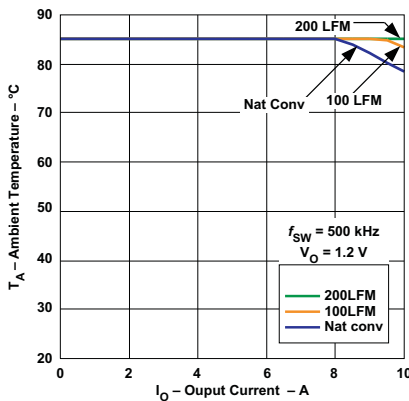

Figure 13.

**AMBIENT TEMPERATURE vs LOAD CURRENT**

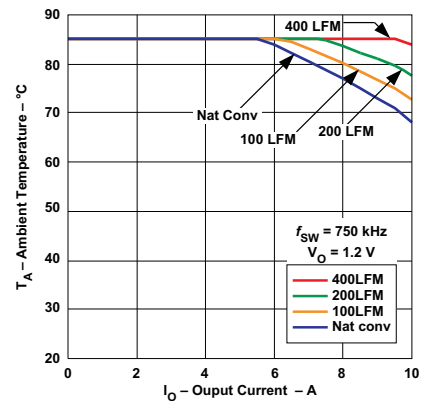

Figure 14.

(1) The temperature derating curves represent the conditions at which internal components are at or below the manufacturer's maximum operating temperatures. Derating limits apply to modules soldered directly to a 100 mm x 100 mm double-sided PCB with 2 oz. copper. Please refer to the mechanical specification for more information.

TYPICAL CHARACTERISTICS ( $V_I = 5\text{ V}$ ) <sup>(1)</sup>

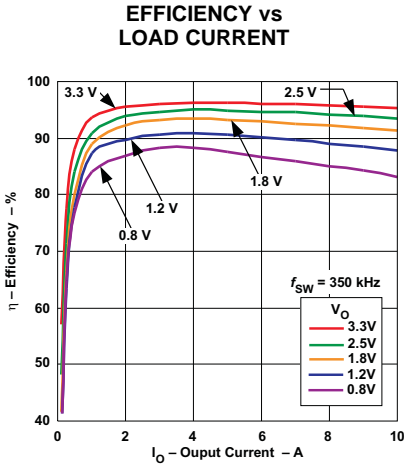

Figure 15.

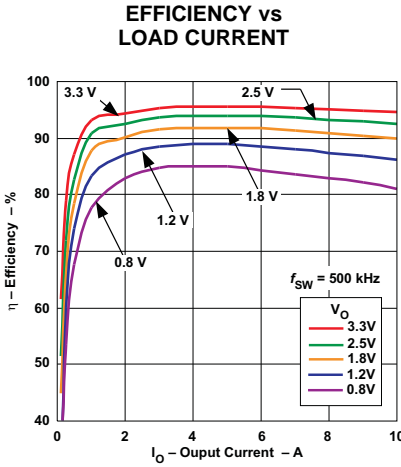

Figure 16.

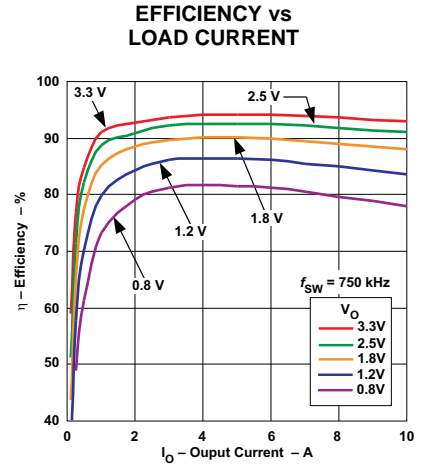

Figure 17.

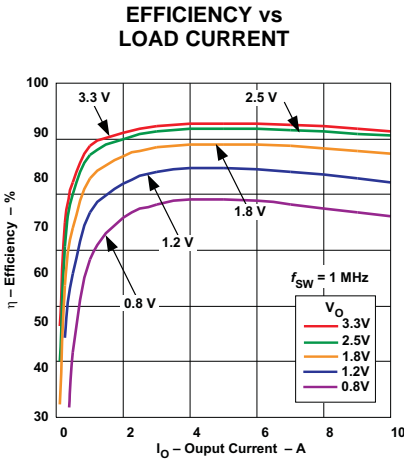

Figure 18.

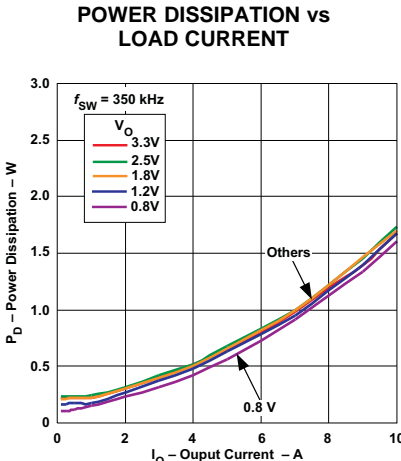

Figure 19.

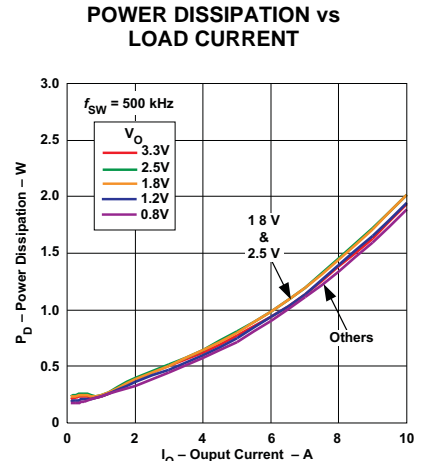

Figure 20.

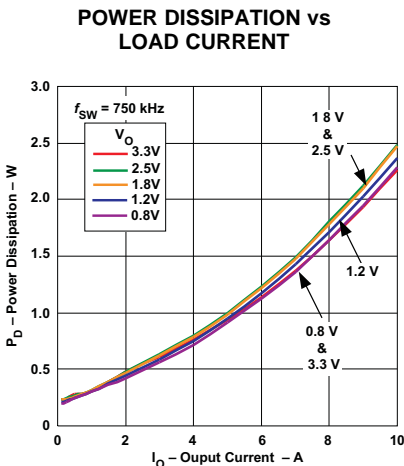

Figure 21.

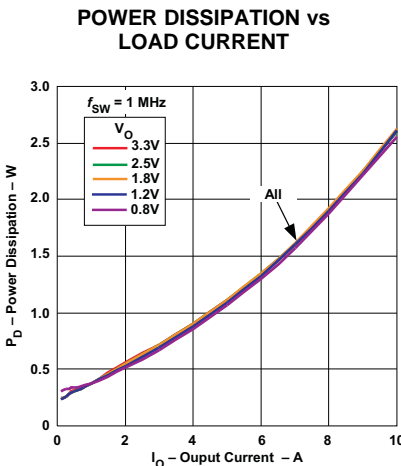

Figure 22.

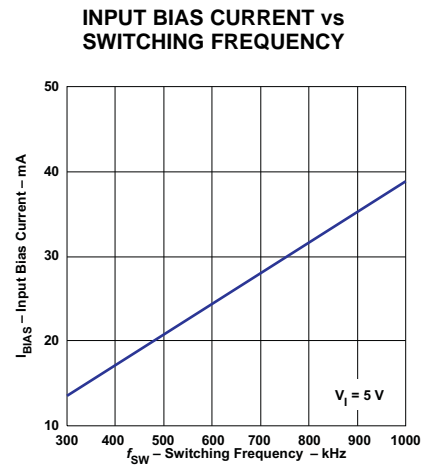

Figure 23.

(1) The electrical characteristic data has been developed from actual products tested at 25°C. This data is considered typical for the converter.



TYPICAL CHARACTERISTICS ( $V_I = 5\text{ V}$ )  
Safe Operating Area <sup>(1)</sup>

AMBIENT TEMPERATURE vs LOAD CURRENT

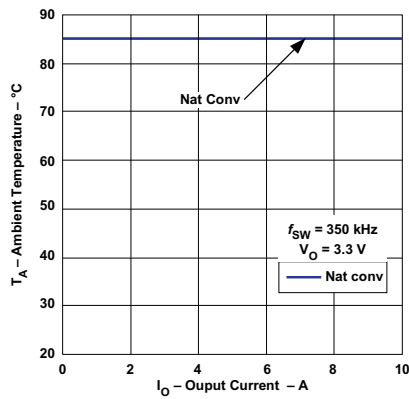

Figure 24.

AMBIENT TEMPERATURE vs LOAD CURRENT

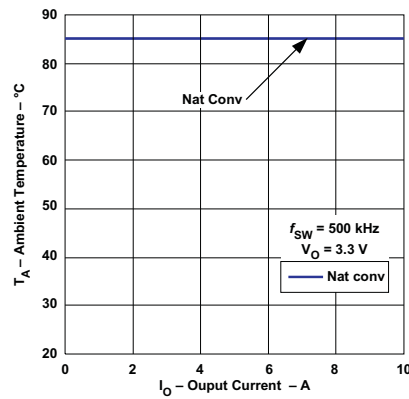

Figure 25.

AMBIENT TEMPERATURE vs LOAD CURRENT

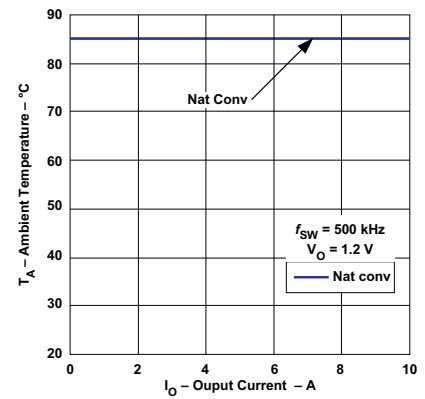

Figure 26.

AMBIENT TEMPERATURE vs LOAD CURRENT

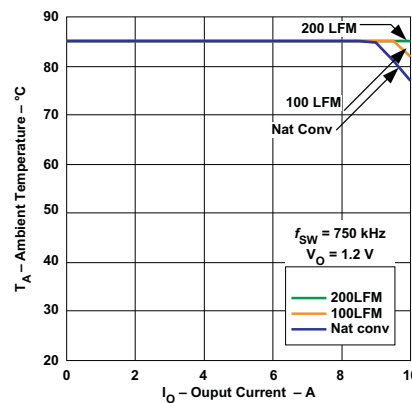

Figure 27.

(1) The temperature derating curves represent the conditions at which internal components are at or below the manufacturer's maximum operating temperatures. Derating limits apply to modules soldered directly to a 100 mm x 100 mm double-sided PCB with 2 oz. copper. Please refer to the mechanical specification for more information.

APPLICATION INFORMATION

Digital Power

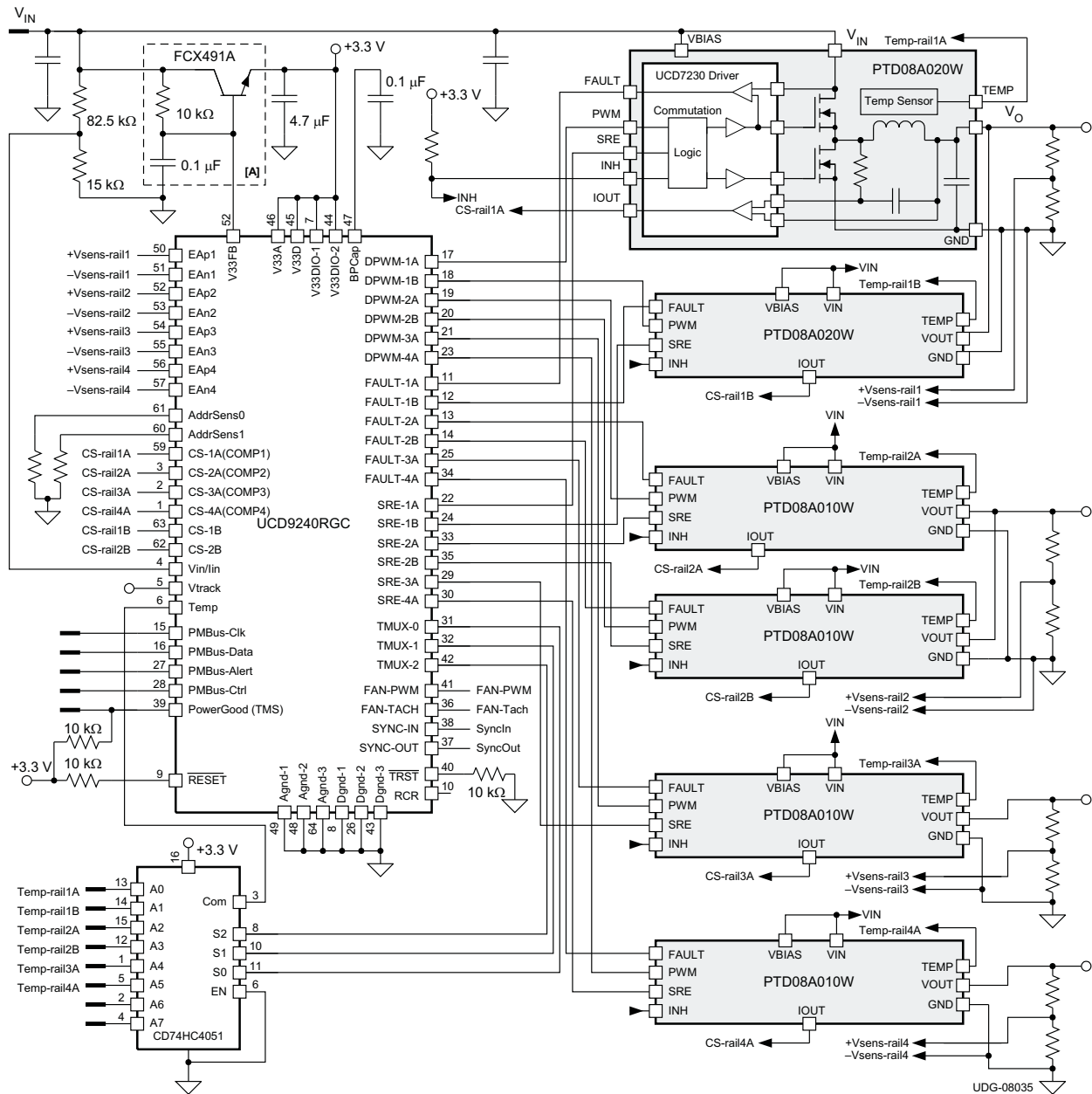

Figure 28. Typical Application Schematic

B. This discrete bias power circuit may be substituted with a low dropout regulator (LDO). For example, [TPS715A33](#) can provide bias power to the UCD9240.

Figure 28 shows the UCD9240 power supply controller working in a system which requires the regulation of four independent power supplies. The loop for each power supply is created by the respective voltage outputs feeding into the Error ADC differential inputs, and completed by DPWM outputs feeding into the UCD7230 drivers which are shown on the PTD08A0x0W modules.

## UCD9240 Graphical User Interface (GUI)

When using the UCD9240 digital controller along with digital PowerTrain modules to design a digital power system, several internal parameters of the modules are required to run the Fusion Digital Power Designer GUI. See the plant parameters below for the PTD08A010W and PTD08A020W digital PowerTrain modules.

**Table 1. PTD08A010W Plant Parameters**

PTD08A010W Plant Parameters			
L ( $\mu\text{H}$ )	DCR ( $\text{m}\Omega$ )	Rds-on-hi ( $\text{m}\Omega$ )	Rds-on-lo ( $\text{m}\Omega$ )
0.90	2.2	3.6	3.6

**Table 2. PTD08A020W Plant Parameters**

PTD08A020W Plant Parameters			
L ( $\mu\text{H}$ )	DCR ( $\text{m}\Omega$ )	Rds-on-hi ( $\text{m}\Omega$ )	Rds-on-lo ( $\text{m}\Omega$ )
1.0	1.5	5.0	2.5

Internal output capacitance is present on the digital PowerTrain modules themselves. When using the GUI interface this capacitance information must be included along with any additional external capacitance. See the capacitor parameters below for the PTD08A010W and PTD08A020W digital PowerTrain modules.

**Table 3. PTD08A010W Capacitor Parameters**

PTD08A010W Capacitor Parameters			
C ( $\mu\text{F}$ )	ESR ( $\text{m}\Omega$ )	ESL ( $\text{nH}$ )	Quantity
47	1.5	2.5	1

**Table 4. PTD08A020W Capacitor Parameters**

PTD08A020W Capacitor Parameters			
C ( $\mu\text{F}$ )	ESR ( $\text{m}\Omega$ )	ESL ( $\text{nH}$ )	Quantity
47	1.5	2.5	2

TRAY

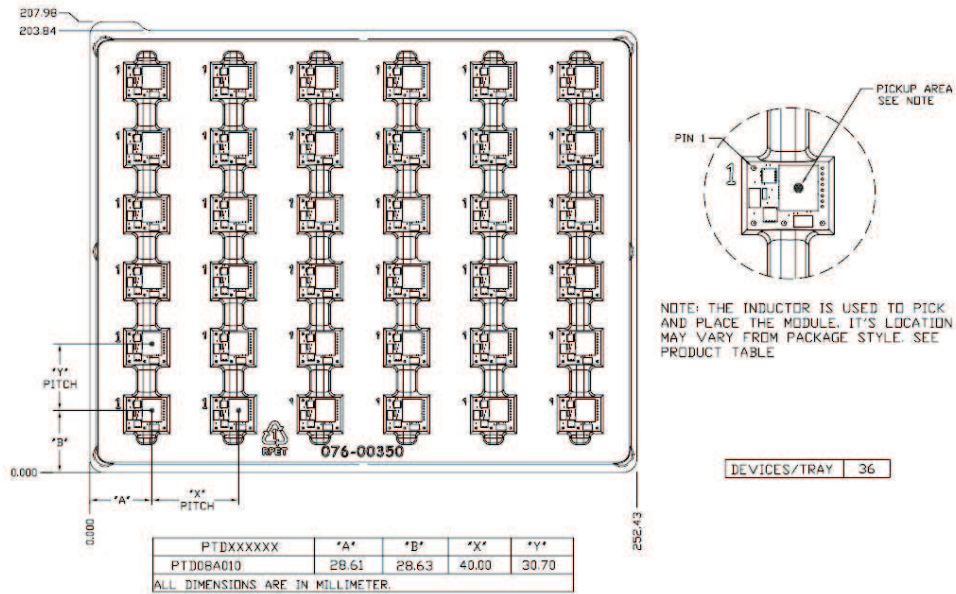

**PACKAGING INFORMATION**

Orderable Device	Status <sup>(1)</sup>	Package Type	Package Drawing	Pins	Package Qty	Eco Plan <sup>(2)</sup>	Lead/ Ball Finish	MSL Peak Temp <sup>(3)</sup>	Samples (Requires Login)
PTD08A010WAD	ACTIVE	Through-Hole Module	EGS	12	36	Pb-Free (RoHS)	SN	Level-1-235C-UNLIM/ Level-3-260C-168HRS	<a href="#">Request Free Samples</a>

<sup>(1)</sup> The marketing status values are defined as follows:

**ACTIVE:** Product device recommended for new designs.

**LIFEBUY:** TI has announced that the device will be discontinued, and a lifetime-buy period is in effect.

**NRND:** Not recommended for new designs. Device is in production to support existing customers, but TI does not recommend using this part in a new design.

**PREVIEW:** Device has been announced but is not in production. Samples may or may not be available.

**OBSOLETE:** TI has discontinued the production of the device.

<sup>(2)</sup> Eco Plan - The planned eco-friendly classification: Pb-Free (RoHS), Pb-Free (RoHS Exempt), or Green (RoHS & no Sb/Br) - please check <http://www.ti.com/productcontent> for the latest availability information and additional product content details.

**TBD:** The Pb-Free/Green conversion plan has not been defined.

**Pb-Free (RoHS):** TI's terms "Lead-Free" or "Pb-Free" mean semiconductor products that are compatible with the current RoHS requirements for all 6 substances, including the requirement that lead not exceed 0.1% by weight in homogeneous materials. Where designed to be soldered at high temperatures, TI Pb-Free products are suitable for use in specified lead-free processes.

**Pb-Free (RoHS Exempt):** This component has a RoHS exemption for either 1) lead-based flip-chip solder bumps used between the die and package, or 2) lead-based die adhesive used between the die and leadframe. The component is otherwise considered Pb-Free (RoHS compatible) as defined above.

**Green (RoHS & no Sb/Br):** TI defines "Green" to mean Pb-Free (RoHS compatible), and free of Bromine (Br) and Antimony (Sb) based flame retardants (Br or Sb do not exceed 0.1% by weight in homogeneous material)

<sup>(3)</sup> MSL, Peak Temp. -- The Moisture Sensitivity Level rating according to the JEDEC industry standard classifications, and peak solder temperature.

**Important Information and Disclaimer:** The information provided on this page represents TI's knowledge and belief as of the date that it is provided. TI bases its knowledge and belief on information provided by third parties, and makes no representation or warranty as to the accuracy of such information. Efforts are underway to better integrate information from third parties. TI has taken and continues to take reasonable steps to provide representative and accurate information but may not have conducted destructive testing or chemical analysis on incoming materials and chemicals. TI and TI suppliers consider certain information to be proprietary, and thus CAS numbers and other limited information may not be available for release.

In no event shall TI's liability arising out of such information exceed the total purchase price of the TI part(s) at issue in this document sold by TI to Customer on an annual basis.

# MECHANICAL DATA

EGS (R-PDSS-T12)

DOUBLE SIDED MODULE

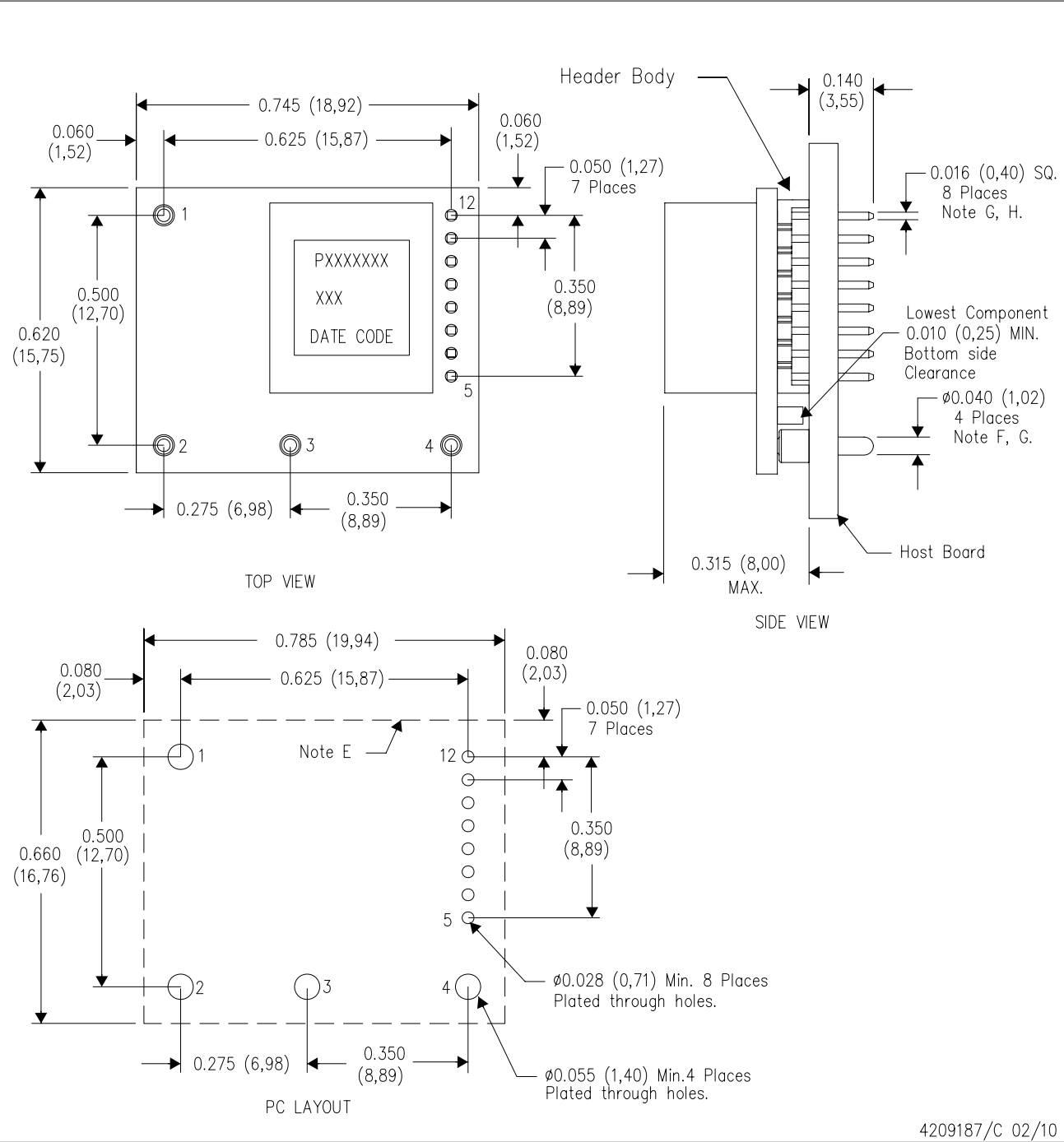

4209187/C 02/10

- NOTES:
- A. All linear dimensions are in inches (mm).
  - B. This drawing is subject to change without notice.
  - C. 2 place decimals are  $\pm 0.030$  ( $\pm 0,76$ mm).
  - D. 3 place decimals are  $\pm 0.010$  ( $\pm 0,25$ mm).
  - E. Recommended keep out area for user components.
  - F. Pins are 0.040" (1,02) diameter with 0.070" (1,78) diameter standoff shoulder.
  - G. Header pins are 0.016 (0,40) SQ.
  - H. All pins: Material - Copper Alloy  
Finish - Tin (100%) over Nickel plate

## IMPORTANT NOTICE

Texas Instruments Incorporated and its subsidiaries (TI) reserve the right to make corrections, modifications, enhancements, improvements, and other changes to its products and services at any time and to discontinue any product or service without notice. Customers should obtain the latest relevant information before placing orders and should verify that such information is current and complete. All products are sold subject to TI's terms and conditions of sale supplied at the time of order acknowledgment.

TI warrants performance of its hardware products to the specifications applicable at the time of sale in accordance with TI's standard warranty. Testing and other quality control techniques are used to the extent TI deems necessary to support this warranty. Except where mandated by government requirements, testing of all parameters of each product is not necessarily performed.

TI assumes no liability for applications assistance or customer product design. Customers are responsible for their products and applications using TI components. To minimize the risks associated with customer products and applications, customers should provide adequate design and operating safeguards.

TI does not warrant or represent that any license, either express or implied, is granted under any TI patent right, copyright, mask work right, or other TI intellectual property right relating to any combination, machine, or process in which TI products or services are used. Information published by TI regarding third-party products or services does not constitute a license from TI to use such products or services or a warranty or endorsement thereof. Use of such information may require a license from a third party under the patents or other intellectual property of the third party, or a license from TI under the patents or other intellectual property of TI.

Reproduction of TI information in TI data books or data sheets is permissible only if reproduction is without alteration and is accompanied by all associated warranties, conditions, limitations, and notices. Reproduction of this information with alteration is an unfair and deceptive business practice. TI is not responsible or liable for such altered documentation. Information of third parties may be subject to additional restrictions.

Resale of TI products or services with statements different from or beyond the parameters stated by TI for that product or service voids all express and any implied warranties for the associated TI product or service and is an unfair and deceptive business practice. TI is not responsible or liable for any such statements.

TI products are not authorized for use in safety-critical applications (such as life support) where a failure of the TI product would reasonably be expected to cause severe personal injury or death, unless officers of the parties have executed an agreement specifically governing such use. Buyers represent that they have all necessary expertise in the safety and regulatory ramifications of their applications, and acknowledge and agree that they are solely responsible for all legal, regulatory and safety-related requirements concerning their products and any use of TI products in such safety-critical applications, notwithstanding any applications-related information or support that may be provided by TI. Further, Buyers must fully indemnify TI and its representatives against any damages arising out of the use of TI products in such safety-critical applications.

TI products are neither designed nor intended for use in military/aerospace applications or environments unless the TI products are specifically designated by TI as military-grade or "enhanced plastic." Only products designated by TI as military-grade meet military specifications. Buyers acknowledge and agree that any such use of TI products which TI has not designated as military-grade is solely at the Buyer's risk, and that they are solely responsible for compliance with all legal and regulatory requirements in connection with such use.

TI products are neither designed nor intended for use in automotive applications or environments unless the specific TI products are designated by TI as compliant with ISO/TS 16949 requirements. Buyers acknowledge and agree that, if they use any non-designated products in automotive applications, TI will not be responsible for any failure to meet such requirements.

Following are URLs where you can obtain information on other Texas Instruments products and application solutions:

<b>Products</b>		<b>Applications</b>	
Amplifiers	<a href="http://amplifier.ti.com">amplifier.ti.com</a>	Audio	<a href="http://www.ti.com/audio">www.ti.com/audio</a>
Data Converters	<a href="http://dataconverter.ti.com">dataconverter.ti.com</a>	Automotive	<a href="http://www.ti.com/automotive">www.ti.com/automotive</a>
DLP® Products	<a href="http://www.dlp.com">www.dlp.com</a>	Communications and Telecom	<a href="http://www.ti.com/communications">www.ti.com/communications</a>
DSP	<a href="http://dsp.ti.com">dsp.ti.com</a>	Computers and Peripherals	<a href="http://www.ti.com/computers">www.ti.com/computers</a>
Clocks and Timers	<a href="http://www.ti.com/clocks">www.ti.com/clocks</a>	Consumer Electronics	<a href="http://www.ti.com/consumer-apps">www.ti.com/consumer-apps</a>
Interface	<a href="http://interface.ti.com">interface.ti.com</a>	Energy	<a href="http://www.ti.com/energy">www.ti.com/energy</a>
Logic	<a href="http://logic.ti.com">logic.ti.com</a>	Industrial	<a href="http://www.ti.com/industrial">www.ti.com/industrial</a>
Power Mgmt	<a href="http://power.ti.com">power.ti.com</a>	Medical	<a href="http://www.ti.com/medical">www.ti.com/medical</a>
Microcontrollers	<a href="http://microcontroller.ti.com">microcontroller.ti.com</a>	Security	<a href="http://www.ti.com/security">www.ti.com/security</a>
RFID	<a href="http://www.ti-rfid.com">www.ti-rfid.com</a>	Space, Avionics & Defense	<a href="http://www.ti.com/space-avionics-defense">www.ti.com/space-avionics-defense</a>
RF/IF and ZigBee® Solutions	<a href="http://www.ti.com/lprf">www.ti.com/lprf</a>	Video and Imaging	<a href="http://www.ti.com/video">www.ti.com/video</a>
		Wireless	<a href="http://www.ti.com/wireless-apps">www.ti.com/wireless-apps</a>

Mailing Address: Texas Instruments, Post Office Box 655303, Dallas, Texas 75265  
Copyright © 2010, Texas Instruments Incorporated